



Coast to Coast



# 2022 CATALOGUE



Your Caravan Store with MORE !!

## FIAMMA PRIVACY ROOMS



See More on Page 009

Classic enclosure suitable for all seasons, the best solution for medium and long term stays.

## QUICK FIT BIKE RACKS



See More on Page 086

Quick Fit Bike Racks are designed to make it easier than ever to take bikes with you on your next adventure. They feature a patented quick connector that makes it extremely quick and easy to fit the racks onto your tow ball!

# CONTENTS

1

## AIR CONDITIONERS (Product Group - 100)

Dometic	004 - 005
Truma	005 - 006
Heating	007 - 008

## PRIVACY ROOMS (Product Group - 150)

Fiamma	009 - 011
Coast Awning Wall Kits	012 - 013
Orbit Annexes	014 - 016

## AWNINGS & ACCESSORIES (Product Group - 200)

Fiamma Awnings	017 - 021
Fiamma Adapter Brackets	021 - 024
Awning Accessories	021 - 028
Floor Matting	029 - 031
Sunscreens	032 - 036
Carefree Awnings and Accessories	037 - 047

## BUILDING MATERIALS (Product Group - 250)

Stabilus Gas Struts	048
Caravan Bed Frames	049
Canopy Lift Mechanisms	050
Pop Top & Camper Parts	051 - 052
Aluminium Extrusion & Mould Infills	052 - 053
Aluminium Cladding	054
Tape Foam	054
Lippert Slide Out Rooms	055 - 056

2

## CAMPING EQUIPMENT (Product Group - 300)

Camping Accessories	060 - 063
Coast Fire Pits	064
Collapsible Homeware	065
Palm Drinkware and Kitchen Accessories	066 - 070

## CAR ACCESSORIES (Product Group - 350)

Towing Accessories	070 - 074
Towing Mirrors	074 - 076
Brake Controllers	077 - 079
CURT Towing Accessories	079 - 082
Tyre Pressure Monitoring	083 - 084
Lippert Swap Command Kit	085
Quick Fit Bike Racks	086 - 087
Carry Bikes and Accessories	088 - 091
Hayman Reese Hitches	092 - 093
Eaz Lift WDH and Accessories	094 - 097
Tips For Safer Towing	098 - 099
Throttle Controllers	100

3

## CARAVAN ACCESSORIES (Product Group - 400)

Dinnerware	104 - 105
Caravan Accessories	106 - 110
First Aid	110
Table Legs and Components	111 - 112
Picnic Tables	114 - 116
Roof Racks and Accessories	117 - 118
Security Handles	118 - 119
Bed Ends and Storage Pockets	119 - 120
ADCO RV Covers and Tyre Guards	121 - 123
Cleaning Products	123 - 124

## CHASSIS EQUIPMENT (Product Group - 450)

Trail-A-Mate	124 - 125
Jacks and Levels	126 - 129
Jockey Wheels and Accessories	129 - 132
Trailer Locks	132 - 133
Steps	133 - 135
Wheel Spats	136
Hub Kits and Accessories	137 - 138
Bearings and Seals	138 - 140
Level Indicators	141
Heavy Duty Couplings	142
Shackles and Couplings	143 - 144
Corner Steadies	144 - 145
Shackle Pins and Nuts	145 - 146
Tow Ball Scales and Weight Controls	146
Purpleline Levellers and Security	147 - 149
Milenco Levellers	150
Stone Shields	151 - 152

4

## ELECTRICAL EQUIPMENT (Product Group - 500)

Fans and Smoke Alarms	156
Battery & Accessories	157 - 159
Narva Electrical Fittings	171 - 175
Power Inlets and Outlets	175 - 177, 181 - 182
Power Points & Switches	176 - 182
Electrical Leads	179 - 180
CMS Equipment	180 - 182
15amp-10amp Adaptors	182 - 183
NARVA Accessory Sockets	183 - 184
Solar Panels	185 - 186
Tyre Inflators (Air Compressors)	186 - 187
Trailer Plugs and Sockets	187 - 189
Cable Ties	189
Caframo Fans	190 - 191
Briggs and Stratton Generators	192

## LIGHTING EQUIPMENT (Product Group - 500)

Lights and Lenses	160 - 162
Truck and Trailer Lighting	163 - 165
Leid Bulbs	166 - 167
Reflectors	168
Sphere™ Wireless Lighting	169 - 170

## GAS EQUIPMENT (Product Group - 550)

Gas Regulators and Hoses	193 - 196
Gas Unions, Nuts and Valves	195 - 198
Gas Cylinders and Cradles	198
Gas Detector	198

5

## CARAVAN HARDWARE (Product Group - 600)

Coast Access Doors	202 - 204
Grab Handles and Cabin Hooks	205 - 206
Theftford Service Doors	206 - 207
Rosettes, Nickels and Door Locks	207 - 209
Valterra Access Hatches	209
Window Parts	209 - 210
DGN Hinges	210
Caravan Cleaners, Touch Up Paint and Sealers	211 - 215

## HATCHES & VENTS (Product Group - 650)

Elixir Mini Vent	216
Ventline Vents and Spares	216 - 217
Unimaxx Replacement Vent Lids	216
Four Seasons Hatch and Spares	217 - 218
Fantastic Vents and Spares	218
Dust Reduction System	218
Fiamma Hatches, Vents and Hatch Spares	219 - 220
MaxxAir Ventilation	221
Skymaxx Ventilation	222 - 223
Exterior, Rotary and Scupper Vents	223 - 224

6

## MAJOR APPLIANCES (Product Group - 700)

Rangehoods	228
Washing Machines and Spare Parts	229 - 231
Fridge Fans	232
Waeco Refrigeration	233 - 234
Dometic Refrigeration and Accessories	234 - 236
Theftford Refrigeration	237 - 240
Theftford Cooking Appliances	240 - 245
Dometic Cooking Appliances	246
Lido Stoves	246
Barbeques	247 - 248
Sphere Microwave	248
My Coolman Fridges	249 - 250
Sphere RVX Fridge Freezers	251 - 252

7

## PLUMBING (Product Group - 800)

Shurflo Pumps and Parts	255 - 260
Lockable Water Fillers	261 - 262
Waste Hose and Drinking Hose	263 - 264
Water Tanks	265 - 267
JG Plumbing Fittings	267 - 272
Plastic Plumbing Fittings	272 - 275
Fuel Safe Cans	276
Accumulator Tanks	276
Tank Monitors and Cleaners	276 - 277
Theftford Sinks, Smev Sinks and Ceramic Sinks	277 - 280
Shower Hoses, Mixers and Hand Pumps	280 - 281
Faucets	282 - 283
Coast Bathroom Accessories	284

## TOILETS (Product Group - 850)

Fiamma Bipots and Theftford Porta Pottis	285 - 286
Theftford Additives Cleaners	287 - 290
Toilet Tissue	290
Theftford Cassette Toilets	291 - 292
Theftford Toilet Accessories and Spares	293 - 294
Valterra Hoses, Valves and Fittings	294 - 295
Camco Sewer Fittings and Hoses	296 - 297
Fiamma Tanks	297
Caravan Loo Treatment	298
Toilet Deodorisers	299 - 300

8

## TV EQUIPMENT (Product Group - 900)

Winegard Antenna and Spares	304 - 307
Antennatek Spare Parts	308 - 309
Foldaway Antenna and Accessories	309
Happy Wanderer Antenna and Spares	309 - 310
Signal Boosters	310
Furion Visions	311
Reversing Cameras	311 - 314
Sphere™ Entertainment	315 - 317
Sphere™ Cables and TV Fittings	318 - 319
Sphere™ Satellite	321 - 322
Sphere Wifi Routers	323
Fusion Entertainment	324
Furion Audio/Visual Entertainment	325 - 328

## WATER HEATERS (Product Group - 950)

Suburban HWS Range	329 - 332
HWS Maintenance Accessories	333 - 335
Suburban Nautilus HWS and Accessories	336 - 339

## LIPPERT BOTTLE CHECK

Easily check gas bottle levels using BottleCheck Bluetooth sensor and smartphone application. BottleCheck gives you peace of mind, measuring the LPG level and alerting you before you run out. BottleCheck can be used on tanks in RVs, caravans, heaters, BBQ grills.

Available in single or double sensor kits.

550-00020



See More on Page 193

## COAST BLUE CAMPING FURNITURE

Coast's new range of camping furniture folds down to a compact size for easy storage and carrying. Featuring locking mechanisms for safety and stability, the range comes with high quality storage bags with carry handles and zips.

**COAST BLUE CAMP CHAIR WITH SIDE BAG & TABLE - 120KG RATED**

300-00910



**COAST BLUE PADDED HI-BACKED CHAIR - 120KG RATED**

300-00912



**COAST BLUE COLLAPSIBLE CAMP CUPBOARD - 30KG RATED**

300-00920



See More on Page 060

## SPHERE HOT POT ELECTRIC BBQ

Enjoy delicious, impressive and healthy food with the two in 1 Sphere Hot Pot Electric BBQ.

Bring the best out of your ingredients with this truly versatile BBQ, it's great for meat, fish, vegetarian and vegan dishes.

The compact and sturdy design makes it a great choice to take caravanning and camping.



700-05950

See More on Page 248

# SECTION 1

## AIR CONDITIONERS

(Product Group - 100)

Dometic	004 - 005
Truma	005 - 006
Heating	007 - 008

---

## PRIVACY ROOMS

(Product Group - 150)

Fiamma	009 - 011
Coast Awning Wall Kits	012 - 013
Orbit Annexes	014 - 016

---

## AWNINGS & ACCESSORIES

(Product Group - 200)

Fiamma Awnings	017 - 021
Fiamma Adapter Brackets	021 - 024
Awning Accessories	021 - 028
Floor Matting	029 - 031
Sunscreens	032 - 036
Carefree Awnings and Accessories	037 - 047

---

## BUILDING MATERIALS

(Product Group - 250)

Stabilus Gas Struts	048
Caravan Bed Frames	049
Canopy Lift Mechanisms	050
Pop Top & Camper Parts	051 - 052
Aluminium Extrusion & Mould Infills	052 - 053
Aluminium Cladding	054
Tape Foam	054
Lippert Slide Out Rooms	055 - 056



# AIR CONDITIONERS

## 100-00007 COAST H40 - AIRCONDITIONER ALUMINIUM ROOF MOUNT H FRAME

### Specifications

400 x 405mm Fit



## 100-00008 COAST H36 - AIRCONDITIONER ALUMINIUM ROOF MOUNT H FRAME - 361 X 365MM FITD

### Specifications

361 x 365mm Fit



## 100-00082 UNIVERSAL AIR CONDITIONER GASKET KIT

Acts as a seal between your air conditioner and your roof to limit rain from entering where the air conditioner has been installed. The kit includes a self adhesive square gasket [356L x 356W (mm)] and x2 self adhesive levelling pads.



## 100-00400 DOMETIC IBIS 4 LOW PROFILE ROOF TOP AIR CONDITIONER (INC. PLENUM 2 PART PICK)

The Dometic IBIS 4 sets a new standard for air conditioning in the mobile living market thanks to

several refinements made from the acclaimed IBIS 3. The Dometic IBIS 4 features a powerful dual-cylinder horizontal compressor, a first for the RV industry, which creates a more balanced roof top unit and reduces the level of vibration.

- > Excellent cooling capacity of 2.6kW
- > Dimensions: 758 x 230 x 1112mm
- > Extremely quiet cooling, even at maximum speed
- > Adjustable vents for even air distribution
- > Lightweight rooftop unit at only 40kg
- > Four fan speeds, including a turbo speed
- > Suitable for both 400 x 400mm and 360 x 360mm roof openings



### Specifications

**Rooftop Dimensions (W x H x D):** 758 x 230 x 1112mm

**ADB Dimensions (W x H x D):** 518 x 48 x 579mm

**Installed Weight:** 40kg

**Compressor Type:** New Generation Variable Speed

**Cooling Capacity:** 2625W

**Current Draw (Cooling):** 6.9A

**Start-up Current:** 7.5A Maximum

**Maximum Current Draw:** 8A Maximum

**Fan Speeds 4:** (including Turbo speed)

**Roof Opening Fitment:** 400 x 400mm or 360 x 360mm

# AIR CONDITIONERS

## 100-00450

### DOMETIC HARRIER LITE ROOF TOP AIR CONDITIONER (INCL PLENUM 2PART PICK)

The Dometic Harrier Lite is Dometic's latest innovation in air conditioning and has been specially designed to fit small to medium-sized caravans, pop-tops, and campers. Dometic has struck a balance between utilising a lightweight, compact design, and an impressive heating and cooling performance. It comes featured with cool, white LED lights, and the dual-cylinder inverter compressor that the market has come to know through the highly sought-after IBIS 4.

#### Dual-Cylinder Inverter Compressor

The Dometic Harrier Lite features an innovative dual-cylinder inverter compressor and its patented design minimises vibration and provides improved performance over conventional compressors. It's this kind of smart design that puts the Harrier Lite in a league of its own and allows RV goers to enjoy cool and fresh air at the touch of a button.

#### Features

- > Easy Control
- > LED Lights
- > Lightweight
- > Dual-cylinder inverter compressor reduces vibration and is highly efficient
- > Low fan noise with three standard speeds
- > Cool white LED lights in the ADB which can be activated via the remote control
- > Adjustable outlet vents with individual vertically adjustable airflow
- > Connectivity with CI-BUS compatible control panels
- > Lightweight for a low centre of gravity
- > Low profile rooftop unit

#### Specifications

Dimensions Product Depth: 997mm  
 Dimensions Product Height: 240mm  
 Dimensions Product Width: 665mm  
 Net Weight: 37kg  
 Input Voltage (AC): 220-240V  
 Cooling Capacity (ISO 5151): 2413W  
 Heating Capacity (ISO 5151): 2421W



## 100-02090

### TRUMA SAPHIR REVERSE CYCLE AIR CON. SAPHIR R/C-KIT

Had enough of balmy days and chilly nights camping out in the van, well it might be the right time to get reverse cycle air-conditioner to make your stay comfortable no matter where or when you camp in this great country and if you don't want any more weight or height on your roof but still want the powerful cooling or the cosy ambient warmth that a roof top A/C offers then the Truma Saphir may be your best friend with a big 2400 watts of cool air & toasty 1700 watts of warmth all effortlessly supplied from a self-contained unit that is even small enough to fit under your bed or the cupboard, all you'll need to do is connect up some ducting to any of the three included outlets and you'll be able to send enough air anywhere you want it in your van for maximum coverage and comfort.

Being a small unit the Saphir air-conditioner it isn't exactly small on features thou as Truma have packed it with everything you need and nothing you don't such as

#### Features

- > Remote Controlled Operation
- > Automatic Heating & Cooling Function
- > 3 Speed Blower with Sleep Mode
- > 3 Outlets Included for Maximum Coverage
- > Will Run off a 2 kVA Generator\*
- > Handles Vans up to 6.5m
- > Ultra-Light Weight at 23.5 Kg & Smallest Sized in its Class
- > Low Mount Installation Provides Lower Centre of Gravity for Your Van Aiding Stability
- > Smart Timer Function - Will Allow a Generous Cooling Time of Up to 15 Hours That Can be Programmed in Advance
- > Pollen Filter to Provide Relief for Allergy Sufferers
- > Closed Refrigeration Circuit Design Provide Maintenance-Free Operation

\* Premium brand generators use only that have genuine 2Kva & above specifications.

#### Specifications

Cooling Capacity: 2.4 kW  
 Heating Capacity: 1.7 kW  
 Power: 240V  
 Max Airflow: 380 m<sup>3</sup>/h or 105 L/s  
 Dimensions: 628 mm x 400 mm 290 mm  
 Weight: 23.5kg  
 Ducting Required: 60mm ID  
 Operating Temperature Range: 4°C to 43°C  
 Warranty: 12 Months



# AIR CONDITIONERS

## 100-02100

### TRUMA AVENTA COMFORT REVERSE CYCLE AIR CONDITIONER

The new Truma Aventa is quite powerful with a surprisingly slim and attractive plenum. It offers 1700W of heating power and a powerful 2400W of cooling capability. Its energy saving heat pump ensures a comfortable temperature inside your RV (provided the outside temperature is greater than 40°C), and it provides dehumidified, cleaned air thanks to its air filter system.

The Truma Aventa cools the inside of your RV quickly and quietly. Its flexible air distribution system allows you to direct the air where it is mostly needed, thus cooling efficiently. It even has a sleep mode function; if this is selected, the evaporator and condenser fans will run slower, resulting in even quieter operation for a restful sleep. The plenum has LED lighting which can be dimmed if ambience is required. It is suitable for RVs up to 7.5m in external length and comes with a remote control with a programmable timer function. Dometic offers a 2 year warranty on the Truma Aventa Comfort.



#### Specifications

**Electrical Rating (single phase):** 240V, 50Hz

**Nominal Cooling Capacity:** 2.4kW

**Nominal Heating Capacity:** 1.7kW

**Max Rated Current - Cooling:** 4.2A

**Max Rated Current - Heating:** 3.7A

**Max Air Delivery:** 400m<sup>3</sup>/hour

**Installed Weight:** 33kg

**Dimensions:** 248H x 523W x 1008L (mm)

**Air Dimensions:** 46H x 670W x 523L (mm)

**Operating Temperature Range:** +4°C to +40°C

## 100-02170

### TRUMA AVENTA COMPACT PLUS A/C. (INCL PLENUM 2 PART PICK). AVENTA COMPACT PLUS KIT

Compact, lightweight cooling power for van conversions to large motorhomes!



- > Fits even on roofs with little space
- > Extremely quiet operation
- > Very light roof-mounted air conditioning system
- > Control intuitively with the easy-to-use remote control

Truma's Aventa Compact Plus roof-mounted air conditioning system is built for maximum power in a minimum amount of space. Its housing unit is compact yet boasts 2,200 watts of cooling power - an upgrade of 500 watts of power compared to the original Aventa Compact.

The Aventa Compact Plus is as small as it is light, so it fits on almost any leisure vehicle roof. This applies even if the roof-mounted air conditioning system shares the space with a top-box, solar panel and satellite dish. With its considerable cooling capacity, it's not just ideal for smaller vans, but also for larger motorhomes if you want to powerfully cool several areas at once. It extracts moisture from the air at the same time as it cools, which contributes to a pleasant room climate. The compressor noise has been minimised, making the Aventa Compact Plus one of the quietest roof-mounted air conditioning systems on the market.

In addition, the Air Distributor Small's individual adjustment options ensure that the cool air is distributed exactly where you want it. All you need to do is adjust the air outlets according to your personal preferences. The Air Distributor Small is designed to be so flat that the passage height is barely affected.

#### Specifications

**External Housing Dimensions (mm):** 560 W x 265 H x 785 D

**Internal Distributor Dimensions (mm):** 523 W x 46 H x 670 D

**Internal Distributor Small Dimensions (mm):** 496 W x 46 H x 556 D

**Power Supply:** 230V - 240 V~, 50Hz

**Power Consumption:** Cooling 4.4A

**Starting Current:** 28A (150ms)

**Cooling Power:** 2.2kW

**Air Volume Flow:** Max. 400m<sup>3</sup>/h

**Usage Limits:** +16°C to 40°C

**Weight:** 29.5kg (with installation materials)



# AIR CONDITIONERS

**100-00461**

**DOMETIC HARRIER PLUS ROOF-TOP AIR CONDITIONER. (INCL PLENUM 2 PART PICK)**

The Dometic Harrier Plus is a rooftop RV air conditioner that is efficient, powerful and quiet. It uses the advanced technology of a dual-cylinder inverter compressor that is smoother and quieter when operating and has a powerful cooling capacity. Featuring a lightweight design and low profile, the Harrier Plus will impress with its functionality, output, cooling and heating.

The innovative dual-cylinder inverter compressor has a patented design that helps reduce vibration and provides improved performance over conventional compressors. It's the kind of smart design that puts Dometic air-conditioners in a league of their own and allows RV owners to enjoy cool and refreshing air at the touch of a button.

- > Cooling capacity of 3.0 kW
- > Dual cylinder inverter compressor means lower energy consumption, noise and vibration
- > 4-speed fan including Turbo mode for rapid cooling or heating
- > Low profile ADB with optimised airflow
- > Lightweight at 44 kg
- > Wide operating temperature range of - 2°C to + 52°C
- > Fitment to both 360 and 400 mm roof opening sizes possible

**Dimensions**

Depth: 1070 mm

Height: 280 mm

Width: 750 mm

Net weight 44 kg

**Electrical**

Input voltage (AC): 220-240 V

Input frequency: 50 Hz

**Performance**

Cooling capacity (ISO 5151): 3028 W

Heating capacity (ISO 5151): 3017 W

Power consumption - Cooling mode (ISO 5151): 1587 W

Power consumption - Heat pump (ISO 5151) - Display: 1357 W



## TRUMA AIR HEATING SYSTEM

The new compact Truma heater for motorhomes, caravans and vans.

The Truma VarioHeat eco is an extremely compact and lightweight heater of the latest generation. It is very powerful and heats your vehicle to the required temperature very quickly. Thanks to the various functions, you can always set the heater to your precise requirements.

- > Powerful caravan heater with two outputs levels
- > Automatic regulation of the heating output depending on the set temperature
- > Lightweight, requires little space
- > Even heat distribution in the vehicle via air outlets
- > Exact setting of the requires room temperature
- > High air throughput for very quick heating

**100-02130**

**TRUMA VARIOHEAT GAS AIR HEATING SYSTEM - VARIOHEAT - KIT**

Includes a basis air kit and is a complete single outlet unit. Includes Black Cowl



**100-02140**

**TRUMA VARIOHEAT GAS AIR HEATING SYSTEM VARIOHEAT - KIT - BLK**

Includes Black Cowl



**100-02136**

**TRUMA VARIOHEAT ADDITIONAL SET WARM AIR**

If a second outlet is required an additional ducting set can purchased. A Truma VarioHeat with two outlets will consist of 100-02130 + 100-02136



**100-02062**

**DOMETIC DUCTING T/S SAPHIR AND CLIMASTER - 15M**



**100-02063**

**TRUMA DUCTING T/S SAPHIR & CLIMASTER 5M LENGTH**



**100-02064**

**DOMETIC DIESEL HEATER DUCTING 60MM T/S D2 - HEATER SOLD PER METRE**



**100-02400****DOMETIC DH AS2 D2L  
SINGLE OUTLET 12V D2  
DIESEL HEATER**

Offering automatic room temperature control, the energy efficient Airtronic Diesel Heaters allow you to set and forget. You simply need to program in a desired temperature and the heater will deliver hot blown air until the desired temperature has been reached. Thanks to their low fuel consumption, they're a great option for those of us who need to run them for long periods of time. Available in both single and twin outlet models, they're a great companion for life on the road.

- > Fully electronic microprocessor control
- > Continuous monitoring
- > Power stage to cut heating times
- > Smooth automatic room temperature control with a temperature pre-set facility
- > Low fuel and power consumption, suitable for longer periods of operation
- > More comfort thanks to wide control range and quiet night-time operation
- > Diagnostic system

**Dimensions**

Depth: 310 mm

Height: 122 mm

Width: 115 mm

Net weight 2.7 kg

**Electrical**

Input voltage (AC): 12 V

**Performance**

Fuel type: Diesel

Fuel consumption peak: 0.28 l/h

**100-02058****DOMETIC BLACK FUEL  
TANK FOR DIESEL HEATER**

A slimline storage canister that holds up to 10L of diesel to run your Dometic heater. It has three bolting points to avoid spillage.

**AUTOTERM AIR HEATERS**

Autoterm air heaters are designed to provide warm air to living areas of vehicles and buses, as well as to cars, motorhomes, campers, in housing and cabins of yachts and ships in the cold seasons.



- > Silent pump. The Autoterm manufactured fuel dosing pump reduces noise output by 95% - perfect for the lightest sleepers.
- > Brushless fan motor. No one else is using this technology that provides much more torque and longer lifetime of the motor.
- > Stepless fan speed. All other heaters use fixed fans speed steps, but Autoterm computer algorithm can precisely choose the fan speed required to achieve the best heater temperature response, which maintains room temperature more accurately and allows more efficiency from the heater.
- > Balanced fan. Each heater fan assembly is run on a balancing machine, the balancing prevents noise and vibration from the heater even at its max speed of 4500rpm. Prevents premature wear of the heater.
- > Air intake silencer included. This is a genuine silencer that helps make Autoterm heaters the quietest heaters in the market.
- > Operation at -40 degrees. These heaters are built not to fail. They are relied on all over the world to provide heat in extreme weather conditions.

**100-02502****AUTOTERM DIESEL  
AIR HEATER 12VOLT  
2KW KIT WITH ROTARY  
CONTROLLER**

The PU-5 Rotary Controller is very easy to operate and install. Simply turn the heater on and adjust the fan speed/heat output with the rotary knob.

**100-02504****AUTOTERM DIESEL AIR  
HEATER 12VOLT 2KW KIT  
WITH DIGITAL CONTROLLER**

The PU-27 Digital Controller is the recommended controller for most people as once you have it set up, you simply press one button and adjust the temperature up or down. It also has other functions the Rotary Controller does not such as multi day timers.

**Specifications**

Fuel: Diesel

Fuel Consumption: 0.1-0.24 L/h

Hot Air Flow: 34-75 m3/h

Set Weight: 6.5kg

Power Consumption: Min 10W to max 29W

Stepless DC Induction Motor

Made in Europe

**100-02510****DIESEL HEATER LOCKABLE FUEL TANK - BLACK - 10L  
(390X390MM)**

# PRIVACY ROOMS

## FIAMMA PRIVACY ROOMS



Classic enclosure suitable for all seasons, the best solution for medium and long term stays.

### Benefits at a glance

- > Quick installation in 15 minutes with Fast Clip poles
- > Ideal for all seasons
- > Composed of one front panel and two side panels
- > All Crystal full light windows that can be rolled up, with Mosquito net and curtains as standard
- > 3 heights are available: Van [S], Medium [M], Large [L]
- > Standard pegs for safe anchoring
- > Complete with Mega Bag to store Privacy Room and poles.

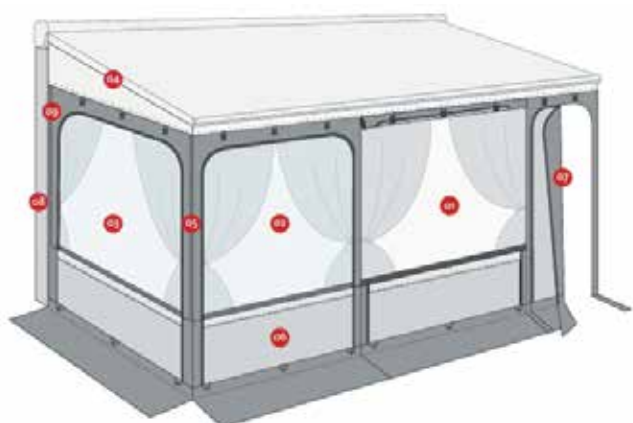

### 1. Panels

With roll-up Crystal full light window, fitted with mosquito net and curtains as standard

### 2. Additional front panels

With fixed Crystal full light window and curtains as standard equipment

### 3. Windows

Equipped with a thick velcro strip for a safe closing of the window

### 4. Fast Clip

For quick and safe hooking to the awning fabric with internal lever hooks

### 5. Zippers

Join the front and side Panels

### 6. Fabric

Waterproof and UV resistant, rot-proof and washable vinyl

### 7. Door

It can be positioned on the left side of the front panel and easily moved to the right side of the same

### 8. Protective sponge

Positioned vertically at the rear of the side panels

### 9. Vertical Rafter

Telescopic aluminium as standard (2 pieces) to lock the protective sponge

# PRIVACY ROOMS

## PRIVACY ROOM F45



Part Number	Basic Module
<b>150-02400 S</b>	P. Room Van 260 Van
<b>150-02402 M</b>	P. Room 300 - Medium
<b>150-02406 L</b>	P. Room 300 - Large

Part Number	Front Panels
<b>150-02451 G</b>	Van 40 cm
<b>150-02453 I</b>	50 cm
<b>150-02455 O</b>	75 cm
<b>150-02456 P</b>	100 cm
<b>150-02457 Q</b>	125 cm
<b>150-02458 U</b>	150 cm
<b>150-02459 W</b>	200 cm

Description	Awning length A	Basic module B	Composition
Privacy Room Van 260	260 cm	Van [S]	[S]
Privacy Room Van 300	300 cm	180-220 cm	[S] + G
P. Room 300 Medium	300 cm	Medium [M] 225-250 cm	[M]
P. Room 350 Medium	350 cm		[M] + I
P. Room 375 Medium	375 cm		[M] + O
P. Room 400 Medium	400 cm		[M] + P
P. Room 425 Medium	425 cm		[M] + Q
P. Room 450 Medium	450 cm		[M] + U
P. Room 300 Large	300 cm		Large [L] 251-280 cm
P. Room 350 Large	350 cm	[L] + I	
P. Room 375 Large	375 cm	[L] + O	
P. Room 400 Large	400 cm	[L] + P	
P. Room 425 Large	425 cm	[L] + Q	
P. Room 450 Large	450 cm	[L] + U	
P. Room 500 Large	500 cm	[L] + W	
P. Room 550 Large	550 cm	[L] + I + W	

## PRIVACY ROOM F65 / F80



Part Number	Basic Module
<b>150-02410 S</b>	P. Room 300 Ducato >06
<b>150-02412 M</b>	P. Room 300 H3 *
<b>150-02414 L</b>	P. Room 300 /H: 245-280 **

Part Number	Front Panels
<b>150-02450 F</b>	20 cm
<b>150-02452 H</b>	40 cm
<b>150-02454 N</b>	77 cm
<b>150-02456 P</b>	100 cm
<b>150-02457 Q</b>	125 cm
<b>150-02458 U</b>	150 cm

\* Designed for Mercedes Sprinter, VW Crafter, Fiat Ducato, Citroën Jumper and Peugeot Boxer - H3, Fast Clip Light aluminium poles delivered as standard.

\*\* This model is suitable for vehicles with straight wall, height from ground 245-280cm.

Description	Awning length A	Basic module B	Composition
P. Room 300 Ducato >06/06	300 cm	Van [S] 245 cm	[S]
P. Room 320 Ducato >06/06	330 cm		[S] + F
P. Room 340 Ducato >06/06	340 cm		[S] + H
P. Room 370 Ducato >06/06	370 cm		[S] + N
P. Room 400 Ducato >06/06	400 cm		[S] + P
P. Room 425 Ducato >06/06	425 cm		[S] + Q
P. Room 450 Ducato >06/06	450 cm		[S] + U
P. Room 300 H3	300 cm	Medium [M] 245-280 cm	[M]
P. Room 320 H3	330 cm		[M] + F
P. Room 340 H3	340 cm		[M] + H
P. Room 370 H3	370 cm		[M] + N
P. Room 400 H3	400 cm		[M] + P
P. Room 425 H3	425 cm		[M] + Q
P. Room 450 H3	450 cm		[M] + U
P. Room 300 / H: 245-280	300 cm	Large [L] 280 cm	[L]
P. Room 320 / H: 245-280	330 cm		[L] + F
P. Room 340 / H: 245-280	340 cm		[L] + H
P. Room 370 / H: 245-280	370 cm		[L] + N
P. Room 400 / H: 245-280	400 cm		[L] + P
P. Room 425 / H: 245-280	425 cm		[L] + Q
P. Room 450 / H: 245-280	450 cm		[L] + U

# PRIVACY ROOMS

**150-01200**

## FIAMMA VEHICLE DRAUGHT SKIRT

Great for protection against wind or rain. The Draught Skirt comes with an installation kit which includes snap fasteners and even has skirting protection for your wheels. It can be shortened if required.



### Specifications

Dimensions: 550L x 60H cm

**150-02200N**

## FIAMMA SIDE W PRO

Fiamma's side panels can be installed on either side of a Fiamma awning. Suitable for use on F45 awnings from 3m long with 2.5m extension.



**200-08096**

## FIAMMA SIDE W PRO CARAVAN STORE

Side panel with a large full light Crystal window and vinyl extension to the floor. Made of rot-proof vinyl, washable fabric with UV protection. Simple to install. Delivered as standard with telescopic tension rafter and elastic hooks and pegs. Suits 2.25m and 2.55m awnings.



**200-08099**

## FIAMMA SIDE W PRO CARAVAN STORE XL

Suits 2.8m, 3.1m and 3.6m awnings

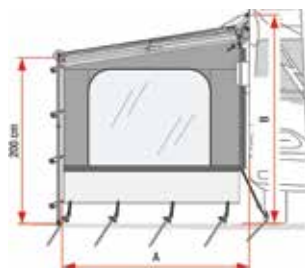

# PRIVACY ROOMS

## COAST AWNING WALL KITS



An inexpensive alternative for Pop Top and Caravan owners to extend your living space whilst on holiday. Innovative design has ensured that each Coast Awning Wall Kit is supplied with three doors (one on each wall), giving you flexibility on which side to open up for access. Suitable for rollout awnings (from 11ft - 18ft) these Awning Wall Kits are made from polyester; not only is polyester easy to wash and dry but it is known for its strength and durability.

### Benefits at a glance

- > Each window comprises three components: an outer polyester flap, Clear PVC and a flyscreen allowing for permanent airflow minus the insects!
- > Installation is flexible (i.e. it can be fitted using telescopic poles or sail track)
- > A draught skirt and wheel kit is provided with each kit, these are made from a light weight grey PVC
- > Adaptable to suit awnings with its guide track at up to 9ft (2.7m) in height and projections of up to 8ft (2.4m)

### Specifications

The walls are constructed of weaved Polyester yarns (0.46mm thick).

The windows are made from clear PVC with a 0.27mm thickness.

The side wall and front wall mudflaps are manufactured from a non-fraying, grey PVC with webbing.

The draft and wheel covers are made from a light weight grey PVC with webbing.

Part Number	Description
<b>150-03070</b>	To Suit 11' Rollout Awning
<b>150-03000</b>	To Suit 12' Rollout Awning
<b>150-03010</b>	To Suit 13' Rollout Awning
<b>150-03020</b>	To Suit 14' Rollout Awning
<b>150-03030</b>	To Suit 15' Rollout Awning
<b>150-03040</b>	To Suit 16' Rollout Awning
<b>150-03050</b>	To Suit 17' Rollout Awning
<b>150-03060</b>	To Suit 18' Rollout Awning



Awning Wall Kit shown has been installed on a Caravan

# KIRRA ANNEX AWNING

## COAST KIRRA ANNEX AWNING AND INNER TENT KIT SET



The Coast Kirra Annex is a must for all motorhomes, vans and caravans that want the convenience of an additional living area but still have the use of the vehicle while camping. This unique drive-away annex can be pitched and left free standing and is easily attached to most vehicles. This has been designed with Australia in mind and comes with a list of true features which will make any camper smile.

### 150-05014

#### COAST KIRRA ANNEX AWNING AND INNER TENT KIT SET

- > Ideal for VW Kombis, Fiat Ducato, Ford Transit vans, Hi-ace, VW transporter range etc.
- > Removable Velcro spline which makes separating the vehicle and tent easy when using rope track
- > Colour coded floor tabs make it quick and easy to attach the floor
- > Connects easily to vehicles when using rope track
- > Multi fit elastic side when attached to vehicle
- > Large Flyscreen Windows
- > Open Air-flow design
- > Awnings over access areas
- > Sealed Zip-In tubed flooring
- > 8ft (240cm) High Ceiling
- > Dual access on either side
- > Double sided front door
- > Two clear windows with roll up blinds
- > Hi-Vis guide ropes
- > Complete with inner tent - creating two rooms
- > Sleeps up to 4
- > Vehicle Height Attachment 180-225cm and 235-280cm

#### Specifications

External foot print: 240 x 340cm

Inner foot print: 210 x 340cm

Internal Height: 210cm

Pack Size: 50cm x 80cm

Weight: 25.9kg

### 150-05010

#### COAST KIRRA ANNEX AWNING ONLY



# ORBIT ASTRO ANNEXE

## ORBIT ASTRO ANNEXE



The Orbit Air Astro Annexe is an inflatable annexe suitable for various caravans and camper trailers.

It is manufactured using high-strength waterproof 300D micro weave poly cotton canvas. Its lightweight structure and modern curved design make it very robust for optimal performance in high winds. The Orbit Air Astro Annexe provides an additional living or storing area while camping or caravanning.

It protects you, your family, your friends and your gear from weather, dirt and insects. It is spacious and filled with light, while offering superior UV protection. Setting-up the Orbit Air Astro Annexe is simple and easy for anyone! You won't believe how soon your annexe will be set up leaving you to kick back and enjoy your caravanning adventures.

The Orbit Air Astro Annexe comes in 2 different heights to suit a multitude of caravan or camper trailer sizes: there is a "low" version for touring caravans and campers, and a "high" version for off-road variants.

### Features

- > Inflatable for easy set-up
- > Roof beam structure for simplistic rigidity
- > Waterproof 300D micro weave poly cotton canvas
- > Superior UV protection: UPF50+
- > Excellent ventilation
- > 3-layered window system (mesh, plastic & canvas)
- > Super quick to set up and take down
- > Wind skirt, ground sheet and dirt skirt included
- > Plastic LED sleeve for fitting an optional LED light strip
- > Pre-attached storm buckles and webbing straps
- > Sail track included
- > Hand pump with pressure gauge included
- > Adjustable ladder bands and steel pegs included
- > All packed in a practical carry bag

**150-06000**

**ORBIT AIR ASTRO ANNEXE 325 LOW**

**150-06002**

**ORBIT AIR ASTRO ANNEXE 325 HIGH**





# ORBIT AIR ANNEXE

## ORBIT COMET ANNEXE



The Orbit Air Comet Annexe is a perfect choice for any camper, who wants a robust annexe that provides extra space, style and convenience without having to pay high price or carry a lot of extra weight.

The Orbit Air Comet is a comprehensive, single-inflation point caravan annexe, manufactured using waterproof 300D micro weave poly cotton canvas.

It is lightweight with a modern curved design, which provides robustness for optimal performance in high winds. The Orbit Air Comet Annexe provides extra living space for family, friends or your gear and protection from weather, dirt and other social undesirables. It is spacious and light-filled, offers superior UV protection and is very simple to set up and take down, which makes it both convenient and also family-friendly. An optional detachable extension room is available for the Comet - the Orbit Air Capsule. This can be fitted at either, or both ends of the Orbit Air Comet Annexe, to create even more useful living or storage space. The Orbit Air Comet Annexe comes in 2 different heights to better suit camper trailers: there is a "low" version for touring campers, and "high" version for off-road variants.

### Features

- > Single inflation point for easy set-up
- > Roof air beam structure for simplistic rigidity
- > Waterproof 300D micro weave poly cotton canvas
- > Superior UV protection: UPF50+
- > Excellent ventilation
- > 3-layered window system (mesh, plastic & canvas)
- > Super quick to set up and take down
- > Wind skirt, ground sheet and dirt skirt for extra protection included
- > Plastic LED sleeve for fitting an optional LED light strip
- > Pre-attached storm buckles and webbing straps
- > Removable side door panels

- > Secondary canvas on side doors
- > Sail track included
- > Hand pump with pressure gauge included
- > Adjustable ladder bands and steel pegs included
- > All packed in a practical carry bag
- > Optional Orbit Air Capsule Extension Room available

**150-06006**

**ORBIT AIR COMET ANNEXE 325 HIGH**



# ORBIT AIR ANNEXE

## 150-06008

### ORBIT COMET CAPSULE

The Orbit Air Capsule is an inflatable extension room for the Orbit Air Comet Annexe. Add even more living or storage space to your Orbit Air Comet Annexe. The Capsule can be fitted at either, or both ends. Use it as a bedroom or for extra storage!

#### Features

- > Single inflation point for easy set-up
- > Waterproof 300D Micro weave poly cotton canvas
- > Superior UV protection: UPF50+
- > Excellent ventilation
- > Super quick to set up and take down
- > Inner tent included
- > Pre-attached storm buckles and webbing straps
- > Adjustable ladder bands and steel pegs included
- > All packed in a practical carry bag



## FIAMMA CARAVANSTORE AWNINGS

A lightweight bag awning with a manual rollout operation. Specifically made for caravans and minivans, the Caravanstore Awning has an extra wide roller tube which can be rewound without the fabric wrinkling. It takes seconds to roll it out and since the legs are inside the roller tube, they too are quick and easy to position. The legs are hinged and telescopic so they can't fall out and get lost. The design of the Caravanstore Awning has been improved recently and it now comes with a Central Rafter fixing kit to ensure a centre rafter is installed safely (from Caravanstore 255). The lead bar now also features a second track so that a sunscreen or LED lights can be utilised.



#### Easy Installation

Slides easily into existing sail track. Once unrolled, simply pull out the legs and position accordingly. When it's time to pack up, the roller tube can be rolled up either way.

#### Colours and Materials

Housed in a soft bag with a self-lubricating zipper that won't get stuck. The canopy is available in Royal Grey and is waterproof, rot proof and UV resistant.

Use the table below to choose the right Caravanstore Awning for your RV.

Part Number	Description	Awning Length (A)	Canopy Length (B)	Extension (C)	Shade Surface	Weight
200-20000	Caravanstore 190	196cm	162cm	180cm	2.9m <sup>2</sup>	6.1kg
200-20002	Caravanstore 225	236cm	202cm	225cm	4.5m <sup>2</sup>	7.6kg
200-20004	Caravanstore 255	266cm	232cm	225cm	5.2m <sup>2</sup>	8.4kg
200-20056	Caravanstore 280	288cm	254cm	225cm	5.7m <sup>2</sup>	9.0kg
200-20058	Caravanstore 310	318cm	284cm	225cm	6.4m <sup>2</sup>	10.2kg
200-20060	Caravanstore 360	369cm	334cm	225cm	7.5m <sup>2</sup>	11.3kg



## FIAMMA AWNINGS

## FIAMMA F35 PRO AWNINGS

Perfect for your minivan, 4x4 or even a station wagon. Housed in a light anodized aluminium case, the Fiamma F35 Pro has a manual mechanism—press the red button on the side of the casing to open and then walk backwards while unrolling the awning. The drop down legs are housed inside the roller tube.



Adapters are available to help with installation onto the roof racks of your vehicle. The fabric is printed on both sides on a UV-resistant and waterproof vinyl. The F35 Pro extends up to 225. Also comes with ropes and hooks for securing to the ground. Available in royal grey colour only.

## 200-20100

## FIAMMA F35 PRO 180

## Specifications

Length: 180cm  
Extension: 180cm  
Weight: 6.0kg

## 200-20102

## FIAMMA F35 PRO 220

## Specifications

Length: 220cm  
Extension: 225cm  
Weight: 8.5kg

## 200-20104

## FIAMMA F35 PRO 250

## Specifications

Length: 250cm  
Extension: 225cm  
Weight: 9.0kg

## 200-20108

## FIAMMA F35 PRO 300

## Specifications

Length: 300cm  
Extension: 225cm  
Weight: 10.5kg

## FIAMMA F45 S AWNINGS

Fiamma's best selling awning has had a few cosmetic changes, with the result being a more compact and functional box awning. The lead bar now has two tracks allowing for use of a sunscreen and/ or LED lights. The F45 S range of awnings are simple to use and easy to install on the wall of your RV or horse trailer. When not in use, the F45 S takes up little space while snugly enclosed in its polar white aluminium case. It is sturdy and safe to operate, with an easy-to-hook winch loop. The canopy is available in five colours and is UV resistant, waterproof and washable. The colour is printed on both sides of the canopy.



Use the table below to help decide which F45 S awning is right for you.

Description	Awning Length (A)	Width (B)	Extension (C)	Shade Surface	Weight
F45 S 190*	185cm	169cm	100cm	1.7m <sup>2</sup>	11.5kg
F45 S 260	263cm	247cm	200cm	4.9m <sup>2</sup>	19.5kg
F45 S 300	308cm	292cm	250cm	7.3m <sup>2</sup>	23kg
F45 S 350	348cm	331cm	250cm	8.3m <sup>2</sup>	24kg
F45 S 400	398cm	381cm	250cm	9.5m <sup>2</sup>	27kg

\* Awning comes without vertical support legs

Aluminium Case Dimension:

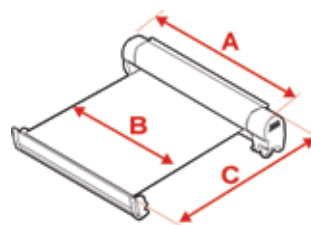

## 200-20200

## FIAMMA F45 S 190

Royal Grey Awning

## 200-20220

## FIAMMA F45 S 230

Royal Grey Awning

## 200-20240

## FIAMMA F45 S 260

Royal Grey Awning

## 200-20260

## FIAMMA F45 S 300

Royal Grey Awning

## 200-20280

## FIAMMA F45 S 350

Royal Grey Awning

## 200-20300

## FIAMMA F45 S 400

Royal Grey Awning

## FIAMMA AWNINGS

**200-20246****FIAMMA F45 S 260**

Deep Black Royal Grey Awning

**200-20264****FIAMMA F45 S 300**

Deep Black Royal Grey Awning

**200-20284****FIAMMA F45 S 350**

Deep Black Royal Grey Awning

**200-20202****FIAMMA F45 S 190**

Royal Blue Awning

**200-20222****FIAMMA F45 S 230**

Royal Blue Awning

**200-20242****FIAMMA F45 S 260**

Royal Blue Awning

**200-20262****FIAMMA F45 S 300**

Royal Blue Awning

**200-20282****FIAMMA F45 S 350**

Royal Blue Awning

**200-20302****FIAMMA F45 S 400**

Royal Blue Awning



## FIAMMA F45 AWNINGS

Perfect for larger RVs the popular F45 TiL has been improved to create the F45 L awnings, featuring an increased box size and extra large roller tube. The F45L awning provides a large shaded area for your family to enjoy on your next holiday. Suitable for mounting onto the wall of your RV, F45 L awnings open and close by means of a crank handle and have a beautiful polar white aluminium case to compliment any RVs exterior. Silent when opening, closing and even during travel, the F45 L range is sturdy and easy to operate. Best of all, the F45 L case features two guide tracks enabling you to have a sunscreen and a front wall installed at the same time if you so choose! Available in two colours, the vinyls are printed on both sides and are UV-resistant, waterproof and washable to ensure you get quality for your money. Supplied with one Straight Centre Rafter as standard (200-04602).



Description	Awning Length (A)	Width (B)	Extension (C)	Shade Surface	Weight
F45 L 450	452cm	435cm	250cm	10.9m <sup>2</sup>	35kg
F45 L 500	502cm	485cm	250cm	12.0m <sup>2</sup>	39kg

Aluminium Case Dimension:

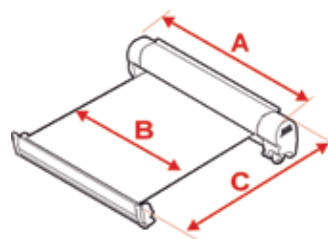
**200-20307****FIAMMA F45 S 450**

Royal Grey Awning

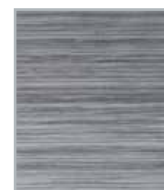
**200-20420****FIAMMA F45 L 500**

Royal Grey Awning

**200-20308****FIAMMA F45 S 450**

Royal Blue Awning

**200-20422****FIAMMA F45 L 500**

Royal Blue Awning

## FIAMMA F80 AWNINGS

## FIAMMA F80 AWNINGS



The new Fiamma F80s Awning range is the new, modern, and compact awning for roof installation. These awnings have an extremely small cross-section that allows it to integrate better with your vehicle's roof line curvature, and feature a number of improvements on its predecessor, the F65s.

**NEW Triple Guide Feature**

Three guides on the lead bar for fitting two front panels, awning shades or walls, and other accessories.

**NEW LED Predefined Position in Lead Bar + Case**

Housing for optional LED strips are built inside the case as well as the lead bar.

**Features**

- > Aluminum End Caps: Newly designed aluminum end caps for maximum strength.
- > Extra-Strong Arms: Wider, reinforced and articulated arms with double steel cables for optimal canopy tension.

**Canopy Finish**

Available in two colours

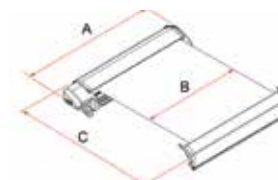

- > Royal Grey
- > Royal Blue



Three Case Colour options available



Description	Awning Length (A)	Canopy Length (B)	Extension Length (C)
Fiamma F80s 290	290cm	278cm	20 0cm
Fiamma F80s 320	320cm	308cm	250cm
Fiamma F80s 340	340cm	328cm	250cm
Fiamma F80s 370	370cm	358cm	250cm
Fiamma F80s 400	400cm	388cm	250cm
Fiamma F80s 425	425cm	412cm	250cm
Fiamma F80s 450	450cm	431cm	250cm

## FIAMMA F80 AWNINGS

F80 POLAR WHITE CASE  
- ROYAL GREY CANOPY FINISH

200-20700  
FIAMMA F80S 290 POLAR WHITE AWNING  
200-20704  
FIAMMA F80S 320 POLAR WHITE AWNING  
200-20708  
FIAMMA F80S 340 POLAR WHITE AWNING  
200-20712  
FIAMMA F80S 370 POLAR WHITE AWNING  
200-20716  
FIAMMA F80S 400 POLAR WHITE AWNING  
200-20720  
FIAMMA F80S 425 POLAR WHITE AWNING  
200-20724  
FIAMMA F80S 450 POLAR WHITE AWNING

F80 POLAR DEEP BLACK CASE  
- ROYAL GREY CANOPY FINISH

200-20756  
FIAMMA F80S 290 DEEP BLACK AWNING  
200-20760  
FIAMMA F80S 320 DEEP BLACK AWNING  
200-20764  
FIAMMA F80S 340 DEEP BLACK AWNING  
200-20768  
FIAMMA F80S 370 DEEP BLACK AWNING  
200-20772  
FIAMMA F80S 400 DEEP BLACK AWNING  
200-20776  
FIAMMA F80S 425 DEEP BLACK AWNING  
200-20780  
FIAMMA F80S 450 DEEP BLACK AWNING

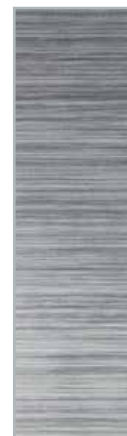
80 POLAR TITANIUM CASE  
- ROYAL GREY CANOPY FINISH

200-20728  
FIAMMA F80S 290 TITANIUM AWNING  
200-20732  
FIAMMA F80S 320 TITANIUM AWNING  
200-20736  
FIAMMA F80S 340 TITANIUM AWNING  
200-20740  
FIAMMA F80S 370 TITANIUM AWNING  
200-20744  
FIAMMA F80S 400 TITANIUM AWNING  
200-20748  
FIAMMA F80S 425 TITANIUM AWNING  
200-20752  
FIAMMA F80S 450 TITANIUM AWNING

F80 POLAR WHITE CASE  
- ROYAL BLUE CANOPY FINISH

200-20702  
FIAMMA F80S 290 POLAR WHITE AWNING  
200-20706  
FIAMMA F80S 320 POLAR WHITE AWNING  
200-20710  
FIAMMA F80S 340 POLAR WHITE AWNING  
200-20714  
FIAMMA F80S 370 POLAR WHITE AWNING  
200-20718  
FIAMMA F80S 400 POLAR WHITE AWNING  
200-20722  
FIAMMA F80S 425 POLAR WHITE AWNING  
200-20726  
FIAMMA F80S 450 POLAR WHITE AWNING



# FIAMMA ADAPTOR BRACKETS

## F80 POLAR TITANIUM CASE - ROYAL BLUE CANOPY FINISH



**200-20730**

**FIAMMA F80S 290 TITANIUM AWNING**

**200-20734**

**FIAMMA F80S 320 TITANIUM AWNING**

**200-20738**

**FIAMMA F80S 340 TITANIUM AWNING**

**200-20742**

**FIAMMA F80S 370 TITANIUM AWNING**

**200-20746**

**FIAMMA F80S 400 TITANIUM AWNING**

**200-20750**

**FIAMMA F80S 425 TITANIUM AWNING**

**200-20754**

**FIAMMA F80S 450 TITANIUM AWNING**



**200-04612**

**FIAMMA CARAVANSTORE  
CENTRE RAFTER XL**



## FIAMMA ADAPTOR BRACKETS

If you like the look of Fiamma's F45 range of awning but your RV does not have a flat-walled surface to mount it on, do not worry! Fiamma have a range of adapter brackets allowing you to fit an F45 awning to your RV, some of which don't require any drilling!

**200-04630**

**FIAMMA AWNING VW  
T2/T3 FITTING  
BRACKETS FOR F45**

Suitable for VW T2 and VW T3 vehicles manufactured after 1980. No drilling required. Kit comprised of x2, 8cm brackets.

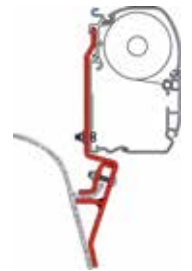

**200-04600**

**FIAMMA CURVED CENTRE RAFTER PRO**

A curved rafter which helps to eliminate water pooling and the canopy from flapping in the wind. It is easy to install, keeps the fabric taut and also provides more under-canopy clearance. Made from two anodized aluminium telescopic bars, the Rafter Pro is best suited to awnings that have an extension of up to 250cm. Its minimum length is 144cm but can extract to 265cm.

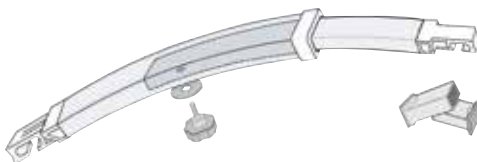

**200-04632**

**FIAMMA AWNING VW  
T4 FITTING BRACKETS  
FOR F45**

Suitable for VW T4 and VW T4 with a Lift Roof. Drilling required. Kit comprised of x2, 8cm brackets.

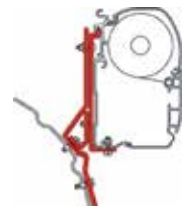

**200-04602**

**FIAMMA STRAIGHT  
CENTRE RAFTER**

Made from anodised aluminium, the Straight Rafter helps to keep the awning taut. It comes with wall clips allowing you to mount it, for storage, inside your vehicle. Best suited to awnings that extend up to 250cm, the Straight Rafter's extension ranges from 142cm - 265cm.



**200-04634**

**FIAMMA AWNING VAN FITTING  
BRACKETS FOR F45**

Suitable for vans such as Fiat Ducato (manufactured before 1994), Ford Transit, Mercedes Sprinter 208D KB. Drilling required. Kit comes with x2 types of brackets (x2 of each supplied), one suits Fiat Ducato (manufactured before 1994); the other suits Ford Transit, Mercedes Sprinter 208D KB. Brackets are 8cm in length.

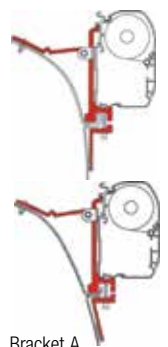

Bracket A

# FIAMMA AWNING ACCESSORIES

## 200-04635

### FIAMMA AWNING FIX INSTALL BRACKET "S" (1PCE)

Suitable for RV's with a flat outer wall. An optional extra bracket for those who wish to strengthen their current mounting. Drilling required. Kit comprises of x1, 12cm "S" bracket.



## 200-04653

### FIAMMA AWNING MOUNTING BRACKET FOR F45 15 DEGREE

Suitable for RV's with a slight curve towards the rooftop and for those wanting to mount the awning closer towards the curve of the roof. Drilling required. Kit comprised of x1, 11cm bracket.

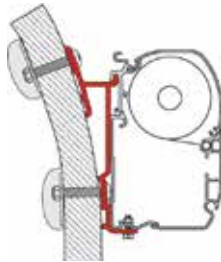

## 200-04681

### FIAMMA F65S AWNING FIXING KIT

Suitable for Fiat Ducato, Citroen Jumper and Peugeot Boxers with high roofs built after June 2006. Comprised of x2 20cm brackets and x1 12cm bracket.



## 200-04682

### FIAMMA F65S AWNING FIXING KIT

Suitable for VW Crafter and Mercedes Sprinters with high roofs built after June 2006. Comprised of x1 12cm bracket, x1 53cm bracket and x1 60cm bracket.



## 200-04714

### FIAMMA F35 AND CARAVANSTORE PLASTIC RIVET

Snap on rivets for the awning leg end on the following models: F35, Caravanstore, F45 and F65. Sold in pairs.



## FIAMMA AWNING RAIN GUARDS

Awning rain guards are a great solution to prevent water from dripping behind the space where your Fiamma awning has been mounted. Made of rubber, the rain guard is installed onto the awning case (no need to remove the awning). Comes in three widths and in 550cm lengths.

## 200-04802

### FIAMMA AWNING RAIN GUARD L 550CM

Suited to awnings that have been fitted using one of the adapter brackets that resulted in a gap of up to 9cm between the awning case and the RV wall. Can also be used on curved walls.

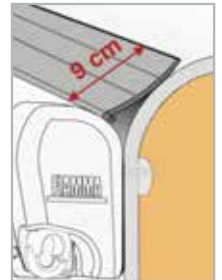

## 200-04806

### FIAMMA AWNING RAIN GUARD M 550CM

For awnings, mounted with adapter spaced out from the wall (up to 4cm) or on curved walls.



## 200-04811

### FIAMMA AWNING RAIN GUARD S 550CM

For awnings installed with the standard AS120 bracket on flat walls. Fits the 1.6cm gap between the flat wall of the RV and the back of the awning case.

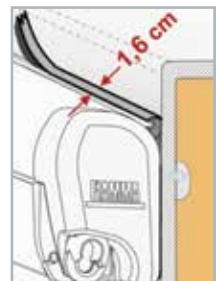

## 200-04896

### FIAMMA WINDING HANDLE TELESCOPIC

This telescopic handle is standard delivered with the F45L awning. Made from light aluminium, it is ideal for high motor homes or caravans, allowing users to easily unwind their awning without stretching. Weighs only 1.32kg. Min length is 154cm but can extend up to 240cm.

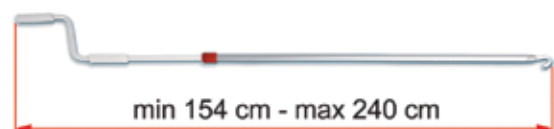



# FIAMMA ACCESSORIES

**200-04898**

**FIAMMA WINDING HANDLE STANDARD 123CM**

This 123cm crank handle is standard delivered with F45S awnings up to 400cm. It has a folding handle and is made of ultra light aluminium. It can be cut down if required and weighs only 0.4kg.



**200-04900**

**FIAMMA WINDING HANDLE SHORT 51CM**

The shortest of Fiamma's crank handles the 51cm version is also made of light aluminium, meaning it only weighs 0.24kg. Ideal for smaller/ lower RVs.

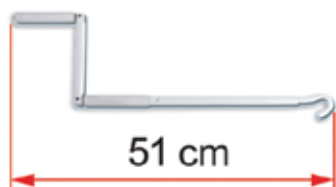

**200-04901**

**FIAMMA ALU WALL BRACKETS FOR AWNING LEGS**

Made of aluminium, these are installed on the outside wall of your RV, allowing you to mount the legs of awning on the side of your RV (instead of vertically dropping to the ground). Suitable for Fiamma F45S, F45L, F65, Caravanstore and F35 awnings. Comes in a set of 2.



**200-04902**

**FIAMMA LEG WALL BRACKET KIT FOR F45 AWNINGS**

These wall brackets are made of a sturdy, white plastic to complement the colour of your RV. Suitable for F45S and F45L awnings. Comes in a set of 2.



**200-04910**

**FIAMMA LEG WALL BRACKET KIT FOR F45 AWN DEEP BLACK**

**200-05316**

**FIAMMA F45 TI SUPPORT LEG REGULATION HAND WHEEL KIT**

This hand wheel secures the extendable legs on Fiamma awnings at the chosen height.



**200-08002**

**FIAMMA FAST CLIP**

Used to attach the walls of a Fiamma Privacy Room to an awning canopy, the improved Fast Clip system is suitable for use on awnings with a 250cm extension only. Its upper bar is now divided into 4 pieces allowing for precise closing at each section. Each section is now stronger with strengthened joints to minimise central bending. The levers have been made stationary (they can't come out of their position) and larger. This allows for easier unhooking. By turning the levers, the grip on the awning canopy can be increased/decreased. The plastic end caps have been shaped to limit damage to the side walls when threading them into the track on the Fast Clip System.

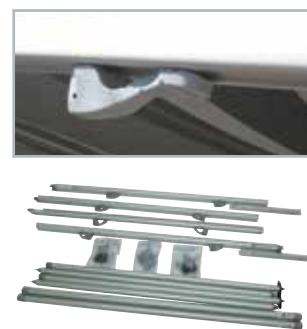

**200-08004**

**FIAMMA TIEDOWNS (BLACK)**

A Fiamma tie-down that allows for solid anchoring. It fits into the awning rails or the side clip of the privacy room. Comes with two 300cm adjustable bands and the necessary stakes and tension springs.

- > 2x Tie Downs
- > 2x Front Hooks
- > 2x Springs
- > 2x Stakes



**FIAMMA ADAPTORS**

**200-08007**

**FIAMMA ADAPTER KIT**

Fiamma Adaptor kit to suit side w pro 4m and under.



**200-08008**

**ADAPTER KIT FOR CLIP SYSTEM TO FIT FIAMMA F65 AWNINGS**



**200-08009**

**ADAPTER KIT FOR CLIP SYSTEM TO FIT FIAMMA F45 TIL AWNINGS**



## FIAMMA ACCESSORIES

250-02037

## FIAMMA DELUXE 5B LADDER

A quality aluminium ladder for sleeping berths in RVs. It has a 15° inclination and handy nylon hooks to hold it in position. The 5B Ladder has five steps.

**Weighs:** 2.6kg



250-02039

## FIAMMA DELUXE 6 DJ

A sturdy and lightweight external ladder with non-skid steps. Made from anodised aluminium, it is supplied with fixing bars for quick and easy installation on the rear door. It can also be combined with the Carry Bike 200 DJ (part number 350-02096). The Deluxe 6 DJ is suitable for installation on the following vehicles: Fiat Ducato, Citroen Jumper, Peugeot Boxer and Ford Transit (with double rear doors built after 2006). It has six steps.

**Weighs:** 6.5kg

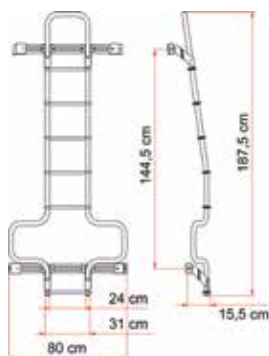

250-02040

## FIAMMA DELUXE 8 EXTERNAL LADDER

A quality aluminium ladder that is sturdy enough for external use. It has a comfortable 24cm step width with non-skid rungs for added safety. The 8 External Ladder can be folded up during travel and can be installed on the following vehicles: Fiat Ducato, Citroen Jumper, Peugeot Boxer and the Ford Transit (with double rear doors built after 2006). It has eight steps.

**Weighs:** 5.5kg



## AUSSIE TRAVELLER ANTI-FLAP KITS

Aussie Traveller's new standard AFK with provision for LED lighting (not available yet but coming soon). Contains an additional external sail-track for the easy addition of a patio awning extension. Aussie Traveller's patented Anti Flap Kit offers a wind and waterproof method to attach walls to your awning.

Aussie Traveller has designed the Anti-Flap Kit (AFK) to help overcome two of the major problems faced by owners of all brands of roll-out awnings.

1. It Helps to Prevent Wind Flap and
2. It has the Ability to Successfully Add Walls.

The Anti-Flap Kit (AFK) breaks down to 4 individual sections (2 pieces per end) which when joined together, form a full-length clamp. This full-length clamp holds to the awning fabrics' outside edge and helps prevent wind flap. It also includes a sail track to accept walls.

200-12300

## AUSSIE TRAVELLER SHORT ANTI FLAP KIT - WITHOUT LED WHITE

Suited to rollout awnings that extend from 210cm up to 220cm



200-12301

## AUSSIE TRAVELLER BLACK SHORT ANTI FLAP KIT - WITHOUT LED

Suited to rollout awnings that extend from 210cm up to 220cm



200-12310

## AUSSIE TRAVELLER MEDIUM ANTI FLAP KIT - WITHOUT LED WHITE

Suited to rollout awnings that extend from 220cm up to 230cm

200-12311

## AUSSIE TRAVELLER BLACK MEDIUM ANTI FLAP KIT - WITHOUT LED

Suited to rollout awnings that extend from 220cm up to 230cm

200-12320

## AUSSIE TRAVELLER LONG ANTI FLAP KIT - WITHOUT LED WHITE

Suited to rollout awnings that extend from 230cm up to 240cm

200-12321

## AUSSIE TRAVELLER BLACK LONG ANTI FLAP KIT - WITHOUT LED

Suited to rollout awnings that extend from 230cm up to 240cm

# AWNING ACCESSORIES

**200-12181**

**AUSSIE TRVELLER  
LOCKING KNOB + T-NUT**

Replacement knob and T-nut that suits Aussie Traveller anti-flap kits and curved roof rafters.



**200-12183**

**AUSSIE TRAVELLER AFK  
BRACKET**

Replacement stainless steel mounting brackets that suit Aussie Traveller anti-flap kits and curved roof rafters.



**200-12186**

**AUSSIE TRAVELLER AFK  
POLE HOLDER BRACKET**

Steel bracket to support a pole along an Aussie Traveller anti-flap kit.



**200-12216**

**AUSSIE TRAVELLER AFK  
CAM HANDLES**

Replacement Aussie Traveller anti-flap kit cam handle with spring and nut.



## AWNING DE-FLAPPER KITS

Helps to protect awnings from costly rips and tears while reducing wind flapping. The de-flapper securely holds the awning fabric by means of hook and loop velcro straps. Made of durable nylon with UV stabilizers.

**200-08170**

**CARAVAN DE-FLAPPER  
KIT WITH VELCRO STRAPS**

(set of 2)

**Specifications**  
Clamp Width: 50mm  
Strap Length: 130mm



**200-08172**

**POP-TOP DE-FLAPPER KIT  
WITH VELCRO STRAPS**

(set of 2)

**Specifications**  
Clamp Width: 50mm  
Strap Length: 300mm



## MAX DE-FLAPPER KITS

A larger version of the original de-flapper with wider grippers to keep the awning vinyl even more stable.

**200-08180**

**MAX CARAVAN  
DEFLAPPER KIT**

(set of 2)

**Specifications**  
Clamp Width: 200mm  
Strap Length: 140mm



**200-08190**

**MAX POP-TOP  
DEFLAPPER KIT**

(set of 2)

**Specifications**  
Clamp Width: 200mm  
Strap Length: 320mm



**200-08019**

**COAST PREMIUM  
AWNING TIE DOWN KIT**

The ultimate tie down kit to keep your awning safe and secure! It can help prevent damage to your awning caused by high winds.



**200-08020**

**HAPPY HOOK AWNING TIE DOWN  
KIT**

Designed to pull the roller tube down to tighten the awning vinyl and reduce flapping caused by wind.



# AWNING ACCESSORIES

## 200-08150 RV AWNING STABILISER KIT

Secure your awning economically. Extra holding power of spiral stakes works well in all kinds of soil. Tension units keep ropes securely taut. Easy-to-use kit stores compactly and fits all roll out awnings. Great for use on the beach, it attaches to the ends of the roller bar on your awning. Fits all awnings



## 200-08160 AWNING HOLD DOWN STRAP KIT

Secures your roll out awning by distributing the tension evenly across the canopy. It is a wrinkle resistant strip that fits awnings up to 25'. Kit includes strap, stakes, springs and brackets.



## 200-08034 RV TWINTRAK FOR HANGING LIGHTS

Suitable for awnings up to 18' (5.5m), the Twintrak conveniently turns a single track into a twin track. It allows you to hang sunscreens, lights or other RV accessories all at the same time. Made from strong plastic the Twintrak is supplied in x6, 3' (x6, 91.4cm) pieces.



## 200-08144 RV AWNING PARTY LIGHT HOOKS

Sturdy sewn fabric tabs with grommets that slide into the roller bar channel of your awning. It enables you to hang lights, wind chimes and other lightweight items from the edge of your canopy. Each pack contains x7 tabs.



## 200-08142 AWNING HARDWARE STRAPS

These Velcro straps allow you to replace old or lost awning straps belonging to your rollout awning. They measure 12" (30.5cm) and can also be used to secure other items such as leads or hoses around your RV. Comes in a pack of two.



## 200-08080 VLP VINYL REPAIR TUBE

Great for mending pinholes, rips or tears on awnings and canvas. VLP is a clear, high strength and flexible adhesive that is suitable for use on most types of flexible vinyl surfaces. It has an air dry formula that dries clear, thus blending with coloured fabric. Typical use is on vinyl furniture, awnings, tarps, vinyl sheeting, luggage, rain gear, covers, tent floors and boots. All surfaces to be glued must be free of oil and dust: to achieve this, simply wipe the surface with alcohol and let it dry before applying VLP.



### Specifications

Temperature Use Range: -10°F to 200°F  
(-23.3°C to 93.3°C)

Tensile: (ASTM D-882) 2900Psi

## 200-08086 CAMCO RV AWNING REPAIR TAPE - 3" WIDE X 15' LONG

Camco's RV Awning Repair Tape is a permanent repair for rips and punctures on your RV awning. Use it for RV, boat sails, canvas, tents, rain wear, backpacks, popup campers and more. It has an aggressive adhesive and resists tearing in any direction. The roll is 7.6cm wide x 4.57m long.



## 200-08270 COAST CURVED ROOF RAFTER (WHITE)

Designed to give your awning canopy a gentle curve enabling rain to run off with ease. Keeping your awning canopy taut it also minimises flapping caused by wind. The Coast Curved Rafter is suitable for awnings that extend up to 8ft (243cm).



# AWNING ACCESSORIES

## COAST PREMIUM RAFTERS

Featuring a curved top which is gentle against awning fabric, these rafters are designed to give your awning a curve and avoid water pooling. This clever rafter also keeps awning fabric taut and to minimise flapping, this is especially helpful during the rainy season, or in windy areas where your awning is more likely to get damaged.

**200-08272**  
**GENTLE-CURVED AWNING RAFTER**

- Extends to 274cm



**200-08273**  
**HIGH-CURVED AWNING RAFTER**

- Extends to 273cm



**200-08276**  
**COAST PREMIUM - BLACK GENTLE-CURVED AWNING RAFTER**

- Extends to 274cm



**200-08278**  
**COAST PREMIUM - BLACK HIGH-CURVED AWNING RAFTER**

- Extends to 273cm



**150-00110**  
**SPIGOT MOUNT BRACKET**

Suitable for use with steel extension poles and curved roof rafters.



## AUSSIE TRAVELLER CURVED ROOF RAFTERS

Curved Roof Rafters have a dual purpose - to prevent the awning canopy from sagging, ensuring water run-off, and for keeping the awning fabric taut, reducing wind flap. Awnings that flap can cause your RV to shake or even cause damage to the awning itself. Aussie Traveller has produced two types of telescopic Curved Roof Rafters - suiting most brands of rollout awnings.

Please see the guide below to see how many rafters are recommended per awning:

Awning Size	Recommendation
11' and under	1
12' - 16'	2
17' - 20'	3
21' and over	4

**200-08280**  
**AUSSIE TRAVELLER CURVED ROOF RAFTER MAXI INCLUDING BRACKET**

**Specifications**  
Curve: 90mm  
Extension: 1400 - 2580 (mm)



**200-08282**  
**AUSSIE TRAVELLER MINI CURVED ROOF RAFTER INCLUDING BRACKET**

**Specifications**  
Curve: 60mm  
Extension: 1400 - 2580 (mm)



**200-12184**  
**AUSSIE TRAVELLER SPIGOT T/S ROOF RAFTER**

Replacement Spigot that suits Aussie Traveller curved roof rafters.



**200-12185**  
**AUSSIE TRAVELLER END HOOK T/S ROOF RAFTER**

Replacement End Hook that suits Aussie Traveller anti-flap kits and curved roof rafters.



**200-34180**  
**CAREFREE AWNING DOOR ROLLER N' DISC**



## CAMPER BAG AWNING POLES

## JAYCO CAMPER BAG AWNING POLES



Designed for Jayco Camper Bag Awnings, these handy poles can be used to replace those that have been lost or damaged.

**Spring Loaded Front Poles**

Available in the range there are 4 sizes of spring loaded Front poles that range from 8 to 12 ft. These support the front length of the awning and can be broken down into smaller sizes for easier storage.

**Upright Pole**

The Upright pole features a rubber foot for grip and stability and are made to clip into a Front pole. The Upright pole can be extended and feature a convenient locking mechanism. Lift the handle and the pole can extend or retract, close the handle and the pole is securely locked in place.

**Top Pole**

The Top pole has a hooked end that slots into the mounting point on a Jayco Camper and are also made to clip into the Front pole. The Top pole can be extended and feature a convenient locking mechanism. Lift the handle and the pole can extend or retract, close the handle and the pole is securely locked in place.



Part Number	Description
<b>200-01002</b>	Upright Pole No 2. UP-2-SM
<b>200-01003</b>	Top Pole No 3. UP-1-SM
<b>200-01008</b>	Front Pole for 8ft Awning. FP-3-8FT
<b>200-01010</b>	Front Pole for 10ft Awning. FP-3-10FT
<b>200-01011</b>	Front Pole for 11ft Awning. FP-3-11FT
<b>200-01012</b>	Front Pole for 12ft Awning. FP-3-12FT



# FLOOR MATTING

## COAST TRAVELITE FLOOR MATTING



Great for any outdoor activity (or even around the home), this floor matting is made from ultra lightweight foamed PVC making it a soft, breathable mat that won't kill the grass! It has a non slip feature so items you place on it will stay where you left them. This is a hard wearing, durable mat that has endless uses. Available in three trendy colours.

**200-08600**

**GREEN – 250CM X 300CM**

(comes with carry bag)

**200-08602**

**GREEN – 250CM X 400CM**

(comes with carry bag)

**200-08604**

**GREEN – 250CM X 500CM**

(comes with carry bag)

**200-08606**

**GREEN – 250CM X 600CM**

(comes with carry bag)

**200-08610**

**GREY – 250CM X 300CM**

(comes with carry bag)

**200-08612**

**GREY – 250CM X 400CM**

(comes with carry bag)

**200-08614**

**GREY – 250CM X 500CM**

(comes with carry bag)

**200-08616**

**GREY – 250CM X 600CM**

(comes with carry bag)



# FLOOR MATTING

## PREMIUM MULTI-PURPOSE FLOOR MATTING



Enhance your outdoor living with Coast's Premium Multi-Purpose Floor Matting, available in 2 colours and 4 sizes options to suit your needs. Made from foamed PVC that is soft, comfortable and breathable the new range is ideal for use in caravan parks, free camping and more.

- Porous and Breathable Foamed PVC with Polymer Fibres
- Extra durable and resistant to wear
- Comfortable under foot
- High grip in wet and dry conditions
- Easy to sweep and keep clean
- Space saving storage bag with carry handle

**200-08630**

**GREEN - 250CM X 300CM - 5KG**

(comes with carry bag)

**200-08632**

**GREEN - 250CM X 400CM - 6KG**

(comes with carry bag)

**200-08634**

**GREEN - 250CM X 500CM - 8KG**

(comes with carry bag)

**200-08636**

**GREEN - 250CM X 600CM - 10KG**

(comes with carry bag)

**200-08640**

**GREY - 250CM X 300CM - 5KG**

(comes with carry bag)

**200-08642**

**GREY - 250CM X 400CM - 6KG**

(comes with carry bag)

**200-08644**

**GREY - 250CM X 500CM - 8KG**

(comes with carry bag)

**200-08646**

**GREY - 250CM X 600CM - 10KG**

(comes with carry bag)





# FLOOR MATTING

## ENDUROMATS

Perfect for camping, these Australian made mats help to keep your RV cleaner. Small dirt particles, such as sand, fall through the mesh, leaving larger stones on top for easy removal. Made of a PVC welded fibre, Enduromats are strong, durable and tough but not on the grass underneath! The mesh style fabric allows air to move beneath its surface allowing grass to breathe. Non-slip and mildew resistant, the lightweight mat is easy to carry and store. Because nothing sticks to the Enduromat, minimal maintenance is required. To clean, simply shake the mat and then fold as per normal to put back into the bag. It is even UV resistant so it will maintain its colour for years.



**200-08400**  
**ENDUROMAT FOREST GREEN**  
 (2M X 2.45M)

**200-08402**  
**ENDUROMAT FOREST GREEN**  
 (3M X 2.45M)

**200-08404**  
**ENDUROMAT FOREST GREEN**  
 (4M X 2.45M)

**200-08406**  
**ENDUROMAT FOREST GREEN**  
 (5M X 2.45M)

**200-08408**  
**ENDUROMAT FOREST GREEN**  
 (6M X 2.45M)

**200-08410**  
**ENDUROMAT FOREST GREEN**  
 (7M X 2.45M)

**200-08450**  
**ENDUROMAT BLACK (2M X 2.45M)**

**200-08452**  
**ENDUROMAT BLACK (3M X 2.45M)**

**200-08454**  
**ENDUROMAT BLACK (4M X 2.45M)**

**200-08456**  
**ENDUROMAT BLACK (5M X 2.45M)**

**200-08458**  
**ENDUROMAT BLACK (6M X 2.45M)**

**200-08460**  
**ENDUROMAT BLACK (7M X 2.45M)**

## TRAVELITE FRONT SUNSCREENS



Coast to Coast have a brand-new range of Travelite Sunscreens that offer plenty of shade and privacy around the RV at an unbeatable price. The new Travelite range is designed to suit most popular awning styles and van types including roll out awnings, box awnings, campers and features end walls to suit both caravans and pop tops. Travelite Sunscreens are a great value solution for additional shade and privacy for your RV's outdoor living area. Each sunscreen is backed by a huge 4-year warranty and features double stitched edges to prevent fraying. Travelite makes fitting a sunscreen as easy as ever, simply thread the spline through the track in your awnings lead bar or utilise the Velcro straps for an end wall. Travelite is the new benchmark for great value sunscreens, each one comes complete with D rings, guy ropes, heavy duty pegs and a convenient, zip-up storage bag.

TRAVELITE FRONT SUNSCREEN  
TO SUIT ROLLOUT AWNING

- › Suitable for use with most popular brands of rollout awnings
- › D-rings, guy ropes and carry bag included



**200-09400**  
COAST TRAVELITE SUNSCREEN - W2805MM X H1800MM  
- T/S 10FT ROLL-OUT AWNING

**200-09402**  
COAST TRAVELITE SUNSCREEN - W3110MM X H1800MM  
- T/S 11FT ROLL-OUT AWNING

**200-09404**  
COAST TRAVELITE SUNSCREEN - W3415MM X H1800MM  
- T/S 12FT ROLL-OUT AWNING

**200-09406**  
COAST TRAVELITE SUNSCREEN - W3720MM X H1800MM  
- T/S 13FT ROLL-OUT AWNING

**200-09408**  
COAST TRAVELITE SUNSCREEN - W4025MM X H1800MM  
- T/S 14FT ROLL-OUT AWNING

**200-09410**  
COAST TRAVELITE SUNSCREEN - W4330MM X H1800MM  
- T/S 15FT ROLL-OUT AWNING

**200-09412**  
COAST TRAVELITE SUNSCREEN - W4635MM X H1800MM  
- T/S 16FT ROLL-OUT AWNING

**200-09414**  
COAST TRAVELITE SUNSCREEN - W4940MM X H1800MM  
- T/S 17FT ROLL-OUT AWNING

**200-09416**  
COAST TRAVELITE SUNSCREEN - W5245MM X H1800MM  
- T/S 18FT ROLL-OUT AWNING

# TRAVELITE FRONT SUNSCREENS

## TRAVELITE FRONT SUNSCREEN TO SUIT FIAMMA AND CAREFREE BOX AWNING

- > Suitable for use with most popular brands of box awnings
- > D-rings, guy ropes and carry bag included



**200-09418**  
COAST TRAVELITE SUNSCREEN - W2850MM X H1800MM  
- T/S 3.0M BOX AWNING

**200-09420**  
COAST TRAVELITE SUNSCREEN - W3350MM X H1800MM  
- T/S 3.5M BOX AWNING

**200-09422**  
COAST TRAVELITE SUNSCREEN - W3850MM X H1800MM  
- T/S 4.0M BOX AWNING

## TRAVELITE CAMPER PRIVACY SUNSCREENS OFFSIDE

Coast to Coast now has a new range of Camper Privacy Sunscreens, that are perfect for shading the kitchen area in most campers as well as providing privacy.



**200-09424**  
COAST TRAVELITE CAMPERVAN OFFSIDE PRIVACY SUNSCREEN W2220MM X H2050MM

**200-09426**  
COAST TRAVELITE CAMPERVAN OFFSIDE PRIVACY SUNSCREEN W2780MM X H2050MM

**200-09428**  
COAST TRAVELITE CAMPERVAN OFFSIDE PRIVACY SUNSCREEN W3060MM X H2050MM

**200-09430**  
COAST TRAVELITE CAMPERVAN OFFSIDE PRIVACY SUNSCREEN W3380MM X H2050MM

## TRAVELITE SIDE SUNSCREEN FOR POP-TOPS

- > One size fits most caravans and can fit the left or the right side depending on your needs
- > D-rings, guy ropes and carry bag included
- > Dimensions: 2100W x 1800H (mm)



**200-09432**  
COAST TRAVELITE SUNSCREEN SIDE WALL FOR POP-TOP (HEIGHT: 1.80M)

## TRAVELITE SIDE SUNSCREEN FOR CARAVANS

- > One size fits most caravans and can fit the left or right side depending on your needs
- > D-rings, guy ropes and carry bag included
- > Dimensions: 2350mm x 2100m x 1900mm



**200-09434**  
COAST TRAVELITE SUNSCREEN SIDE WALL FOR FULL VAN (HEIGHT: 1.90M/2.35M)

## PREMIUM COAST FRONT SUNSCREENS



Coast's range of sunscreens has been redesigned resulting in a stronger and more functional sunshade. The front and side sunscreens now feature an improved spline that won't kink over time. There are also newly added reinforcing triangles (with D-rings) that enable the sunshade to be secured to awning legs. They are still quick and easy to fit. Once you have taken it out of the packaging, shake it out like a blanket and grab the end without the eyelets. Simply thread it through the track on your awning lead bar.

**Key Features**

- > Improved spline
- > Added reinforced triangles with D-rings
- > Hemmed edging all around to prevent fraying
- > Comes with guy ropes and heavy duty 8mm steel pegs (for securing to the ground)
- > Offers extra privacy
- > Now with a huge 5 year warranty

**ARPAN5A Test Results**

- > Cover Factor: 91.0 +/- 2.5
- > UVR Block: 90.4% +/- 2.5%
- > Shade Factor: 86.6 +/- 2.9
- > Calculated Protection Factor: 11\*

\* The Calculated Protection Factor is for the material only and does not account for the effect of indirect UVR when situated at a distance from the persons being protected.

Now available in Black finish

## FRONT SUNSCREENS FOR ROLLOUT AWNINGS

- 200-09002 - Grey Finish
- 200-09005 - Black Finish
- SUITS 10' ROLLOUT AWNING (W2805MM X H1800MM)**
- 200-09012 - Grey Finish
- 200-09015 - Black Finish
- SUITS 11' ROLLOUT AWNING (W3110MM X H1800MM)**
- 200-09022 - Grey Finish
- 200-09025 - Black Finish
- SUITS 12' ROLLOUT AWNING (W3415MM X H1800MM)**
- 200-09032 - Grey Finish
- 200-09035 - Black Finish
- SUITS 13' ROLLOUT AWNING (W3720MM X H1800MM)**
- 200-09042 - Grey Finish
- 200-09045 - Black Finish
- SUITS 14' ROLLOUT AWNING (W4025MM X H1800MM)**
- 200-09052 - Grey Finish
- 200-09055 - Black Finish
- SUITS 15' ROLLOUT AWNING (W4330MM X H1800MM)**
- 200-09062 - Grey Finish
- 200-09065 - Black Finish
- SUITS 16' ROLLOUT AWNING (W4635MM X H1800MM)**

# SUNSCREENS

**200-09072** - Grey Finish  
**200-09075** - Black Finish  
**SUITS 17' ROLLOUT AWNING (W4940MM X H1800MM)**

**200-09082** - Grey Finish  
**200-09085** - Black Finish  
**SUITS 18' ROLLOUT AWNING (W5245MM X H1800MM)**

*\* Rollout awning sunscreens have a 6mm spline*

## FRONT SUNSCREENS FOR BOX AWNINGS

**200-09102** - Grey Finish  
**200-09105** - Black Finish  
**SUITS FIAMMA AND CAREFREE 3M BOX AWNING (W2850MM X H1800MM)**

**200-09112** - Grey Finish  
**200-09115** - Black Finish  
**SUITS FIAMMA AND CAREFREE 3.5M BOX AWNING (W3350MM X H1800MM)**

**200-09122** - Grey Finish  
**200-09125** - Black Finish  
**SUITS FIAMMA AND CAREFREE 4M BOX AWNING (W3850MM X H1800MM)**

*\* Box awning sunscreens have a 3mm spline*



**200-09192**  
**REPLACEMENT BAG FOR 10" - 12" SUNSCREENS**

**200-09194**  
**REPLACEMENT BAG FOR 13" - 16" SUNSCREENS**

**200-09196**  
**REPLACEMENT BAG FOR 17" - 18" SUNSCREENS**

## COAST SIDE SUNSCREENS

Available to suit Pop Tops and Caravans, the Coast Side Sunscreens are made from the same quality material as the Front Sunscreens. In the case of a Pop Top, the side sunshade attaches to your awning arm (when extended) by means of velcro straps. If you have a Caravan, you have two installation options; 1) use the Velcro straps to attach it to your awning arm or, 2) if you already have an antiflap device installed with sail track, simply thread the side sunshade spline through the track. Comes with guy ropes and pegs to secure to the ground. Comes with a huge 5 year warranty!

**200-09202** - Grey Finish  
**200-09205** - Black Finish  
**SIDE SUNSCREEN FOR POP-TOP (W2100 X H1800MM)**



**200-09212** - Grey Finish  
**200-09215** - Black Finish  
**SIDE SUNSCREEN FOR CARAVANS**

*\* Can also fit into the Fiamma Fast Clip System*



**200-09198**  
**REPLACEMENT BAG FOR SIDE SUNSCREENS**

## CAMPER OFFSIDE PRIVACY SUNSCREENS

Coast to Coast now has a NEW range of camper privacy sunscreens. These are perfect for shading the kitchen and fridge area in most campers as well as providing privacy.

- > Used on the offside of the camper for extra shade and privacy
- > No poles required with a height of 2050mm
- > Suitable for use with most popular brands of camper vans
- > Huge 5 year warranty

**200-09300** - Grey Finish

**200-09305** - Black Finish

**CAMPER OFFSIDE PRIVACY SUNSCREEN  
(W2220 X H2050MM)**

**200-09302** - Grey Finish

**200-09315** - Black Finish

**CAMPER OFFSIDE PRIVACY SUNSCREEN  
(W2780 X H2050MM)**

**200-09304** - Grey Finish

**200-09325** - Black Finish

**CAMPER OFFSIDE PRIVACY SUNSCREEN  
(W3060 X H2050MM)**

**200-09306** - Grey Finish

**200-09335** - Black Finish

**CAMPER OFFSIDE PRIVACY SUNSCREEN  
(W3380 X H2050MM)**



## COAST FRIDGE VENT SUNSCREENS

**200-09350** - Grey Finish

**200-09355** - Black Finish

**COAST FRIDGE VENT SUNSCREEN**

Designed to shade the fridge area of your RV. The Coast Fridge Sunscreen will lower the ambient temperature around your fridges vents allowing the fridge to perform better on hot sunny days. The Coast Fridge Sunscreen comes with almost everything you need to install the screen yourself, including 1100mm of sailtrack and eight 12mm x 6 gauge stainless steel mounting screws. To give the finishing touches, the installation kit also includes mould insert to cover the mounting screws and specially designed caps for each end of the sailtrack.

## Features

- > DIY Installation Kit (includes sailtrack, mounting screws, mould insert and end caps)
- > Kink free 6mm spline
- > Tough reinforced D-rings
- > Hemmed edges all around to prevent fraying
- > Guy ropes and heavy duty 8mm steel pegs (for securing to the ground)
- > Comes with a huge 5 year warranty.



# CAREFREE ALTITUDE

## CAREFREE ALTITUDE

Altitude introduces a new high in awning intelligence and style. This advanced awning helps set your RV apart from the crowd with features you might find on much higher priced products.

Altitude makes the outdoors the 'coolest' part of any RV. Today's RV owners enjoy entertainment, connectivity and technology that simplify RV living. Our Altitude awnings are loaded with the latest technological features including operation through the Bluetooth™ enabled smart phone app that allows you to extend, retract your awning, turn of/on or dim the LED light, and even adjust Carefree Motion's sensitivity to wind.

Altitude™ has been developed to provide OEMs an easy to install, contemporary patio awning that fits the lifestyles and tastes of today's younger, more tech savvy, on-the-go RV buyers. It follows Carefree's automotive styling and is designed to complement the Caravan sidewall rather than clutter it.

### Features

- > **Memory Pitch.** Awning extends out to the same pitch it was retracted from.
- > **Exclusive Pitch Adjustments.** Now with easier to use buttons for adjustment and you can change the pitch when the awning is closed!
- > **Bluetooth Enabled.** The optional wireless awning control system and mobile app allows you to control awning extension, retraction, LED lighting, and the sensitivity of the wireless motion sensor right from your mobile device.



**200-37200**  
**120INCH/10FT SILVERFADE**

**200-37210**  
**132INCH/11FT SILVERFADE**

**200-37220**  
**144INCH/12FT SILVERFADE**

**200-37230**  
**156INCH/13FT SILVERFADE**

**200-37240**  
**168INCH/14FT SILVERFADE**

**200-37250**  
**180INCH/15FT SILVERFADE**

**200-37260**  
**192INCH/16FT SILVERFADE**

**200-37270**  
**204INCH/17FT SILVERFADE**

**200-37280**  
**216INCH/18FT SILVERFADE**

**200-37290**  
**228INCH/19FT SILVERFADE**

**200-37300**  
**120INCH/10FT BLACK REVERSE FADE**

**200-37310**  
**132INCH/11FT BLACK REVERSE FADE**

**200-37320**  
**144INCH/12FT BLACK REVERSE FADE**

**200-37330**  
**156INCH/13FT BLACK REVERSE FADE**

**200-37340**  
**168INCH/14FT BLACK REVERSE FADE**

**200-37350**  
**180INCH/15FT BLACK REVERSE FADE**

**200-37360**  
**192INCH/16FT BLACK REVERSE FADE**

**200-37370**  
**204INCH/17FT BLACK REVERSE FADE**

**200-37380**  
**216INCH/18FT BLACK REVERSE FADE**

**200-37390**  
**228INCH/19FT BLACK REVERSE FADE**

## CAREFREE ALTITUDE AWNING HARDWARE

Suitable for pop-tops & caravans due to their compact height. The pitch angle is adjustable with six different levels thanks to a simple but sturdy pin setup. The Altitude hardware also features inbuilt shocks for reliability that will soak up bumps and jarring while on the road. They are strong enough to support the awning without the use of legs, but if your planning longer stays, Carefree recommend the use of their HD Support Pole Kit 200-33066 (coming soon).

**200-33014**  
**CAREFREE ALTITUDE WHITE AWNING HARDWARE SET**



**200-33016**  
**CAREFREE ALTITUDE BLACK AWNING HARDWARE SET**



# CAREFREE ALTITUDE

## 200-37430

### CAREFREE ALTITUDE BT-12 CARAVAN ELECTRONICS

This optional electronics kit enables Bluetooth™ operation of the Altitude through a compatible smart device. It also includes a Combination switch that allows a Master ON/OFF as well as a one touch EXTEND or RETRACT button. This kit allows you to:

- > Open & Close the awning
- > Turn the LED light bar On
- > Adjust the brightness of your LED light bar
- > Position the angle of the LED by bringing in or taking out the Awning
- > Adjust the optional motion switches sensitivity to complete override if this is installed
- > Get your exact extension every-time you open the awning via setting the memory in the app
- > Bluetooth module included



## 200-37438

### CAREFREE ALTITUDE BT-12 CONTROL MODULE

This part here is a replacement Bluetooth module on its own if required, its function is to communicate all functions from the switch or app to the awning.



## 200-37440

### CAREFREE ALTITUDE LED SWITCH WITH FUSE

Simply an on/off switch to operate the LED bar from the inside of the van, this switch can be installed in any inside location but will need to be hardwired in to work. simple item for a simple operation & includes a fuse for added safety.



## ALTITUDE ACCESSORIES

## 200-37432

### CAREFREE ALTITUDE BT-12 MOTION SWITCH

This switch mounts on the awning to detect unwanted motion such as wind. If extreme wind is detected it will tell the awning to promptly get out of harm's way by automatically retracting. This is a great bit of insurance should you be away from your van and the wind suddenly picks up.



## 200-37442

### CAREFREE ALTITUDE EXTEND & RETRACT SWITCH WITH DYNAMIC BRAKE

If the BT-12 option is not suited to your customers, maybe due to it being too "TECH SAVVY" for the end user or if the OEM wants to still have the New Motorised hardware for ease of operation but it's a cost sensitive option then this Manual operation switch will be needed at a minimum. To use simply hold down the OUT button to extend the awning and when the awning is fully extended you let go of the button, to retract simply hold down the IN button and again let go when the awning is completely rolled up in its travel position. If your customer wishes to use their OWN switching/control system ensure it has a "DYNAMIC BRAKE" ability built into the switch or the unit will not operate correctly.



## 200-37434

### CAREFREE ALTITUDE BT-12 REMOTE

A great little extra as with this simple remote control so you can open and close your awning as well as turn on the LED & adjust the brightness without having open up a smart device.



## 200-37436

### CAREFREE ALTITUDE BT-12 SWITCH KIT

This is a replacement switch which is mounted to the interior of the van which is then hardwired into the BT Module, it will control the basic operation of the awning being extend or retract as well as master power on/off switch.





# CAREFREE ALTITUDE

## 200-33066

### CAREFREE ALTITUDE HD SUPPORT POLE KIT

The new Carefree Altitude HD Support Pole Kit is a purposed-designed support pole kit to suit Carefree's Altitude Awnings, and other rollout awnings without support legs. Staying in one place for an extended time with an Altitude awning will require them to have some kind of upright support.

The HD Support Pole Kit comes with two connecting heads so it can be used to support awnings with roll bars as well as box awnings. They are designed to fit both Carefree and other branded awnings.

Important! When using this kit with Altitude awnings, or any powered awning, ensure that the awning's power is switched OFF prior to installation! This prevents any sensors the awning has from activating and causing it to retract. If you need to adjust the awning pitch after set up, loosen the pole's straps and lower before adjusting.

#### Features

- > Cradle head to support awnings with roll bars
- > Stabiliz'r Grip head to allow securing to a box awning
- > Poles feature crank knobs to secure the pole to the adjusted height
- > Comes with stakes and straps to secure the poles to the ground and awning.
- > Designed for quick set up, under 5 minutes!



## 200-33070

### CAREFREE STRAIGHT RAFTER - WHITE

## 200-33072

### CAREFREE STRAIGHT RAFTER - BLACK



Carefree's new Straight Rafter is a straight rafter designed to add rigidity and further support to your awning.

Installing the Straight Rafter is simple and easy with two methods of connecting to the roller tube available. The rafter can be attached using the pin with a hole drilled into the roller tube or with no drilling into the roller tube required the mounting cradle fits around the roller tube and firmly holds the rafter in place.

The Straight Rafter also includes an industry first utility slot to quickly hang side blockers, side panels or other awning accessories.

The Straight Rafter is available in Black and White hardware colour options.

## 200-33080

### CAREFREE CURVED RAFTER - WHITE

## 200-33082

### CAREFREE CURVED RAFTER - BLACK



Carefree's new Curved Rafter is a curved rafter designed to add rigidity and further support to your awning.

Installing the Curved Rafter is simple and easy with two methods of connecting to the roller tube available. The rafter can be attached using the pin with a hole drilled into the roller tube or with no drilling into the roller tube required the mounting cradle fits around the roller tube and firmly holds the rafter in place.

The Curved Rafter also includes an industry first utility slot to quickly hang side blockers, side panels or other awning accessories.

The Curved rafter is available in Black and White hardware colour options .

## CAREFREE ROLL OUT WINDOW AWNINGS

Window awnings offer an alternative to roll out awnings but still provide essential protection from the sun. Carefree have modified their window awnings to incorporate a more streamlined design. The vinyl has also been given an update to an opaque white, complementary to any RV exterior. Two types of Carefree Window Awning are available, the SL and the SL XL. The SL window awning is suitable for windows less than 36" (91cm) in height. If your window is more than 36" in height, you will require the SL XL window awning.



## 200-31012

### SL 4FT WHITE WINDOW AWNING

## 200-31014

### SL 5FT WHITE WINDOW AWNING

## 200-31016

### SL 6FT WHITE WINDOW AWNING

## 200-31512

### 4FT WHITE SL XL WINDOW AWNING

## 200-31514

### 5FT WHITE SL XL WINDOW AWNING

# CAREFREE AWNINGS

## CAREFREE WINDOW AWNING HARDWARE

**200-31902**

### SL WHITE WINDOW AWNING HARDWARE

Capable of 18" (46cm) extension

**200-31960**

### SL XL WHITE WINDOW AWNING HARDWARE

Capable of 30" (76cm) extension



## CAREFREE FIESTA ROLL OUT AWNINGS (NO ARMS)

Carefree's vinyl fabric features a superior construction with the top portion being called the Weatherguard - this protects the fabric from the sun, scrapes and exposure when the awning is rolled up. The Carefree Fiesta has long been a favourite amongst RVers, not only in the USA but here in Australia as well. It is a simple to use manual, spring loaded, rollout awning featuring a vinyl weatherguard as previously mentioned. The 8' - 14' awnings project up to 7'3" (2.21m), while the awnings from 15' - 21' project up to 7'9" (2.36m).



### Fiesta Features

#### Remote and Travel Locks

These work together to ensure the Fiesta does not come undone during travel. They eliminate the need for you to stretch and fumble for the roller lock.



#### Canopy Clamps

Built onto the hardware and self storing. Canopy Clamps help to keep your awning taught and provide extra protection from the elements. Not available on arms supplied to suit pop-tops.



#### Heavy Duty Brackets

Solid and rugged, the awning hardware and castings are white to suit the trim of any RV.



#### Single Track Slider

Located on the inside of the hardware channels, it eliminates the rafter binding during setup and storage. You get a smooth gliding motion as soon as you slide the rafters up the hardware arms



## CAREFREE ROLL OUT AWNINGS

**200-36900 10FT BLACK SHALE FADE**

**200-36910 11FT BLACK SHALE FADE**

**200-36920 12FT BLACK SHALE FADE**

**200-36930 13FT BLACK SHALE FADE**

**200-36940 14FT BLACK SHALE FADE**

**200-36950 15FT BLACK SHALE FADE**

**200-36960 16FT BLACK SHALE FADE**

**200-36970 17FT BLACK SHALE FADE**

**200-36980 18FT BLACK SHALE FADE**

**200-36990 19FT BLACK SHALE FADE**

**200-36992 20FT BLACK SHALE FADE**

**200-36994 21FT BLACK SHALE FADE**



**200-36400 10FT BLUE SHALE FADE**

**200-36410 11FT BLUE SHALE FADE**

**200-36420 12FT BLUE SHALE FADE**

**200-36430 13FT BLUE SHALE FADE**

**200-36440 14FT BLUE SHALE FADE**

**200-36450 15FT BLUE SHALE FADE**

**200-36460 16FT BLUE SHALE FADE**

**200-36470 17FT BLUE SHALE FADE**

**200-36480 18FT BLUE SHALE FADE**



# CAREFREE AWNINGS

200-36500 10FT BURGUNDY SHALE FADE

200-36510 11FT BURGUNDY SHALE FADE

200-36520 12FT BURGUNDY SHALE FADE

200-36530 13FT BURGUNDY SHALE FADE

200-36540 14FT BURGUNDY SHALE FADE

200-36550 15FT BURGUNDY SHALE FADE

200-36560 16FT BURGUNDY SHALE FADE

200-36570 17FT BURGUNDY SHALE FADE

200-36580 18FT BURGUNDY SHALE FADE



200-36700 10FT SILVER SHALE FADE

200-36710 11FT SILVER SHALE FADE

200-36720 12FT SILVER SHALE FADE

200-36730 13FT SILVER SHALE FADE

200-36740 14FT SILVER SHALE FADE

200-36750 15FT SILVER SHALE FADE

200-36760 16FT SILVER SHALE FADE

200-36770 17FT SILVER SHALE FADE

200-36780 18FT SILVER SHALE FADE

200-36790 19FT SILVER SHALE FADE

200-36792 20FT SILVER SHALE FADE

200-36794 21FT SILVER SHALE FADE



## CAREFREE LED AWNINGS

Carefree's new LED awning option will make you the envy of the campsite with an adjustable light that is bright enough to read by. This fun, energy-saving dimmable LED's look incredible & are great for parties or just enjoying the evening outside. The 11'-15' awnings project up to 7'3" (2.21m), while the awnings from 16'-20' project up to 7'9" (2.36m).

200-37010 11FT LED SILVER SHALE FADE

200-37020 12FT LED SILVER SHALE FADE

200-37030 13FT LED SILVER SHALE FADE

200-37040 14FT LED SILVER SHALE FADE

200-37050 15FT LED SILVER SHALE FADE

200-37060 16FT LED SILVER SHALE FADE

200-37070 17FT LED SILVER SHALE FADE

200-37080 18FT LED SILVER SHALE FADE

200-37090 19FT LED SILVER SHALE FADE

200-37092 20FT LED SILVER SHALE FADE



# CAREFREE AWNINGS

## CAREFREE TRIPLE BLACK AWNING

It is a simple to use manual, spring loaded, rollout awning featuring a vinyl weatherguard as previously mentioned.

Sizes vary - the 11' - 14' awnings project up to 7'3" (2.21m), while the awnings from 15' - 20' project up to 7' 6 3/4" (2.30m).

### Features

- > Black Springs
- > Black Weather Guard (so they roll up black)
- > Black Shale Fade Canopy (when rolled out the canopy has a black balance)

### LED

200-37110 11FT TRIPLE BLACK SHALE FADE

200-37120 12FT TRIPLE BLACK SHALE FADE

200-37130 13FT TRIPLE BLACK SHALE FADE

200-37140 14FT TRIPLE BLACK SHALE FADE

200-37150 15FT TRIPLE BLACK SHALE FADE

200-37160 16FT TRIPLE BLACK SHALE FADE

200-37170 17FT TRIPLE BLACK SHALE FADE

200-37180 18FT TRIPLE BLACK SHALE FADE

200-37190 19FT TRIPLE BLACK SHALE FADE

200-37192 20FT TRIPLE BLACK SHALE FADE

### NO LED

200-35710 10FT FIESTA TRIPLE BLACK SHALE FADE

200-35720 11FT FIESTA TRIPLE BLACK SHALE FADE

200-35730 12FT FIESTA TRIPLE BLACK SHALE FADE

200-35740 13FT FIESTA TRIPLE BLACK SHALE FADE

200-35750 14FT FIESTA TRIPLE BLACK SHALE FADE

200-35760 15FT FIESTA TRIPLE BLACK SHALE FADE

200-35770 16FT FIESTA TRIPLE BLACK SHALE FADE

200-35780 17FT FIESTA TRIPLE BLACK SHALE FADE

200-35790 18FT FIESTA TRIPLE BLACK SHALE FADE



When replacing the Spring Assembly on your Carefree Fiesta (rollout) awning, take note of the following:

### SPRING WIND CHART

Length of Awning	Winds with Awning Closed	Winds with Awning Open
7'11" or less	6	14
8' - 12'	5	13
12' 1" - 18'	7	15
18' 11" and longer	8	16

To wind, rotate the end plug over the top and away from the RV

To unwind, rotate the end plug over the top and toward the RV

## CAREFREE ECLIPSE AWNINGS

The Carefree Eclipse awning is yet another innovative design from these 40 year strong manufacturers. It is a 12V electric awning that extends (and retracts) at the touch of a button (usually mounted near the door of your RV). You can choose to unwind it partially or to its 2.3m full extension. As the worm-gear motor unwinds the canopy, the arms glide up the vertical track (mounted to the outside wall of your RV). The end result is a stable canopy with truss like support. To retract the Eclipse simply hold the button and the motor will roll it up tight against your RV and that's it, eliminating the need to fumble for roller locks:



### Eclipse Features

#### Unmatched Performance

Eclipse has remarkable strength and support for an automatic awning, not to mention it's stylish good looks.



### Self Levelling

No need to level the canopy before you roll it up and the genius part is that when you do unwind it again, it will unwind to its last setting.



### Rain-dump Feature

When your Eclipse is on a flat pitch and rain is pooling on the canopy, the gas strut will momentarily retract and dump the water.



### Adjustable Pitch

There are 6 settings on the awning arm giving you options to maximise shelter from the sun and rain.



# CAREFREE AWNINGS

**200-36800**

**14' ECLIPSE 12V SILVER SHALE FADE  
(NO ARMS, NO SPRINGS)**

**200-36810**

**15' ECLIPSE 12V SILVER SHALE FADE  
(NO ARMS, NO SPRINGS)**

**200-36820**

**16' ECLIPSE 12V SILVER SHALE FADE  
(NO ARMS, NO SPRINGS)**

**200-36830**

**17' ECLIPSE 12V SILVER SHALE FADE  
(NO ARMS, NO SPRINGS)**

**200-36840**

**18' ECLIPSE 12V SILVER SHALE FADE  
(NO ARMS, NO SPRINGS)**



*\* All Carefree awnings are sold in two components, the vinyl and the hardware (arms). The hardware required will vary depending on size and type of RV. Please contact a Coast Team member to determine the correct hardware for your RV.*

**200-33000**

**CAREFREE WHITE SHORT HARDWARE (POP TOP)**

Best suited for Pop Tops or smaller caravans with a straight outer wall i.e. walls with a height of 1.6m - 1.7m from the floor line up to the awning railing.



**200-33002**

**CAREFREE BLACK SHORT HARDWARE (POP TOP)**

Suitable for use on Pop Tops or smaller caravans with a straight outer wall i.e. walls with a height of 1.6m - 1.7m from the floor line, up to the awning railing.



**200-33008**

**CAREFREE BLACK LONG HARDWARE (UNIVERSAL)**

Suitable for use on larger caravans with a straight outer wall i.e. walls with a height of 1.7m - 2.1m from the floor line, up to the awning railing.



**200-33010**

**CAREFREE WHITE LONG HARDWARE (UNIVERSAL)**

Best suited for larger caravans with a straight outer wall i.e. walls with a height of 1.7m - 2.1m from the floor line up to the awning railing. Comes with remote lock.



**200-33012**

**CAREFREE AWNING HARDWARE 12V ECLIPSE**

12V Awning arms to suit the Eclipse awning. Must be fitted to a flat-walled caravan or motor home. It is 10.8cm wide and requires 1.8mt from the awning rail to the floor line.



**200-33020**

**CAREFREE WHITE CURVED HARDWARE  
BENT TOP AND BENT LEG**

Suits RV's with a curved outer wall.

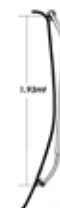

**200-33022**

**CAREFREE WHITE CURVED HARDWARE  
BENT TOP AND STRAIGHT LEG**

Suits most RV's with a curved roof such as Winnebagos and Renault Trafic.

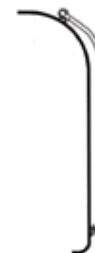

**200-34150**

**CAREFREE SPIGOT KIT FOR  
CAREFREE  
RAFTERS**

The Spigot pin fits into the end of the Carefree Centre Rafter, which is then inserted into the awning barrel when extended.



**200-33030**

**CAREFREE RAFTER STANDARD**

The standard rafter has an awning support cradle and is easy to use. The end with the awning support cradle attaches to your RV wall, allowing the rafter to swing out towards the awning roller (once extended). Simply tighten the knob on the roller and use the lever to fit to the roller. You can make the canopy as tight as you desire but take care not to stress your canopy roller. Comes in polar white and suits the Carefree Fiesta range of awnings.



**200-33040** - White

**200-33042** - Black

**CAREFREE RAFTER  
WITH GROUND SUPPORT**

Has the same benefits as the standard rafter but with an additional ground support leg. This prevents the awning roller from sagging (towards the ground) once the awning has been rolled out. The ground support and roller work together to keep the awning roller straight. Comes in polar white.

In storage  
on the side  
of your RV



Ground  
Support  
in use



**CAREFREE SUPPORT CRADLE**

Fits all roller awning brands, the awning support has a pivoting head. Once you roll up your awning, the pivoting head receives the roller and supports it, eliminating weight stress and potential bowing in the centre of your awning roller. The awning supports will not damage the awning fabric. Recommended for use on flat walls of RVs and for awning widths of 16ft or greater.

**200-33050**

**CAREFREE AUTOMATIC AWNING  
SUPPORT CRADLE WHITE**



**200-33060**

**CAREFREE AUTOMATIC  
AWNING SUPPORT CRADLE  
BLACK**



# CAREFREE AWNING SPARE PARTS

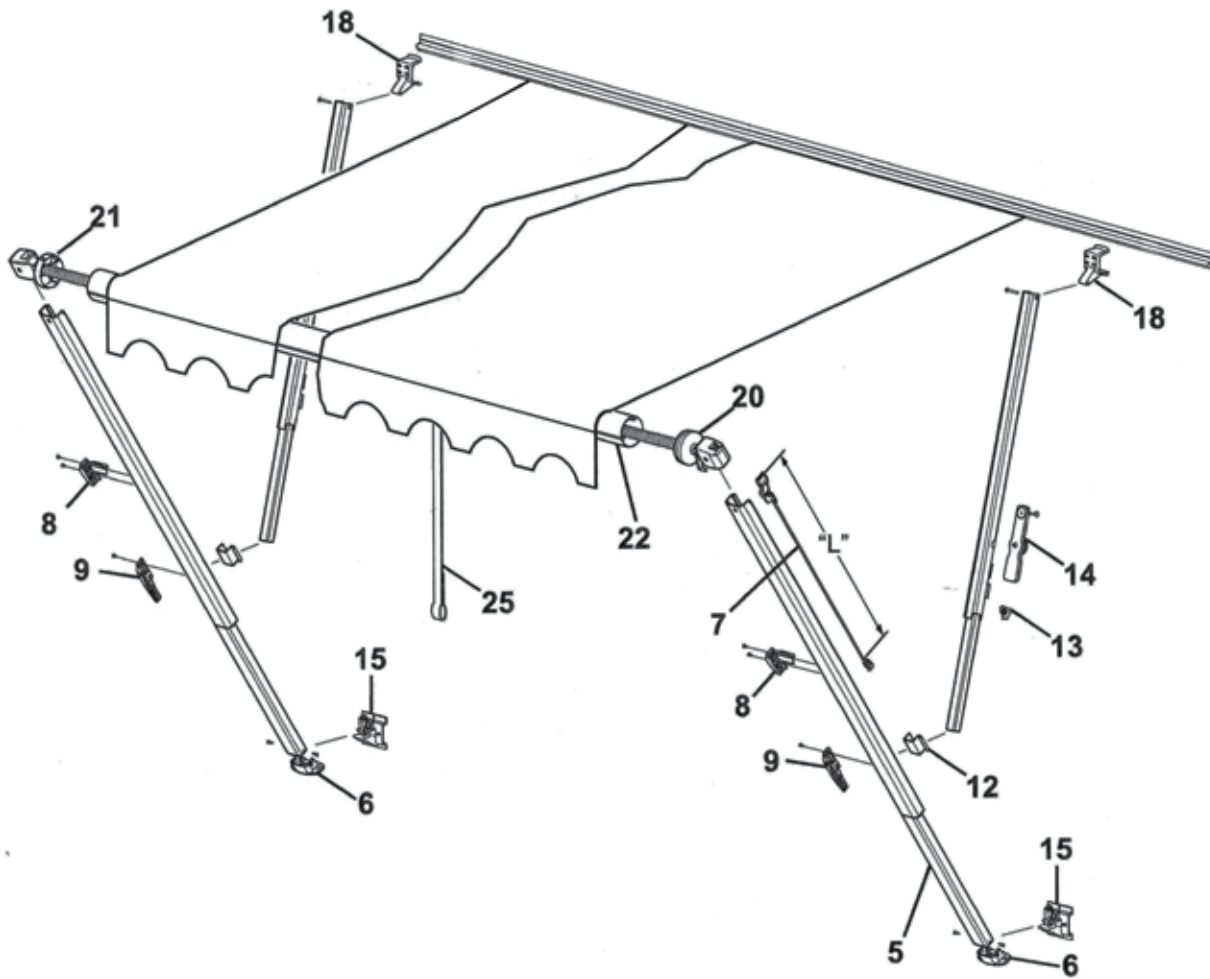

No.	Carefree Part No.	Coast Part No.	Description
6	901020	<b>200-34200</b>	Carefree BLACK car port foot for main inner arm
	901020W	<b>200-34070</b>	Carefree WHITE car port foot for main inner arm
7	901046W	<b>200-34040</b>	Carefree hardware remote lock WHITE - length: 38.5" (97.8cm)
	901046	<b>200-34214</b>	Carefree hardware remote lock BLACK - length: 38.5" (97.8cm)
8	901017	<b>200-34202</b>	Carefree BLACK travel lock
	901017W	<b>200-34050</b>	Carefree WHITE travel lock
9	901015W	<b>200-34060</b>	Carefree WHITE lift handle
	901015	<b>200-34204</b>	Carefree BLACK lift handle
12	R00405	<b>200-34090</b>	Carefree brace slider assembly
13	901022	<b>200-34120</b>	Carefree pair of BLACK locking knob with nut
14	902801W	<b>200-34130</b>	Carefree pair of WHITE canopy clamps
15	901019W	<b>200-34080</b>	Carefree WHITE bottom bracket
	901019	<b>200-34206</b>	Carefree BLACK bottom bracket
18	901018W	<b>200-34140</b>	Carefree WHITE top bracket
	901018	<b>200-34208</b>	Carefree BLACK top bracket

20	R00925WHT	<b>200-34032</b>	Carefree WHITE spring assembly cam end for 8'to18' awning (r/hand)
	R00925BLK	<b>200-34212</b>	Carefree BLACK spring assembly cam end for 8'to18' awning (r/hand)
	R00926WHT	<b>200-34036</b>	Carefree spring assembly cam end 18' to 21' awning (r/hand)
21	R00923WHT	<b>200-34030</b>	Carefree WHITE spring assembly non cam end for 8'to18' awning (l/hand)
	R00923BLK	<b>200-34210</b>	Carefree BLACK spring assembly non cam end for 8'to18' awning (l/hand)
	R00924WHT	<b>200-34034</b>	Carefree spring assembly non cam end 18'to21' awning (l/hand)
25	R022406-001	<b>200-34160</b>	Pull down strap for Carefree Fiesta awning
	030573	<b>200-34194</b>	Carefree Screw 1/4" 20UNC x 1/4" LG S/Steel
	R030345-007-MP	<b>200-34196</b>	Carefree Semi Tube Rivet
	901035	<b>200-34170</b>	Carefree Pull Down Wand

Note: Awning 7'11" and shorter use only x1 R/Hand Spring i.e. there is no L/Hand Spring

# CAREFREE AWNINGS

## TIPS FOR CAREFREE AWNINGS: CARE AND MAINTENANCE

### Fabric Care

- > Do not use oil-based cleaners or any granulated/ abrasive type cleaners on your Carefree awning.
- > The easiest way to delay the need for a deep clean is to simply hose down the awning fabric once a month with clear water - this prevents dirt from becoming set in into the fabric.
- > When the time comes for a thorough cleaning, you can leave the fabric on the frame. For vinyl fabric, simply use a soft brush and warm water with a natural soap. Allow the fabric to air dry completely before rolling back up.

### Mildew

- > A fungus that looks like dirt.
- > Common in areas where temperature and humidity is high, mildew can become a problem.
- > Rinse fabric with clean water and allow to air dry completely before rolling back up.

### Leaking

- > On vinyl canopies, side hems and poly cords are stitched with a sewing machine.
- > The stitching may allow water to seep through - this is normal and not a warranty defect.
- > In this instance, treat the seams with a seam sealer.

### Arm Care

- > Always keep this clean to allow the arms and braces to operate smoothly.
- > Periodically wash out the arm channels with a hose to keep them clean and eliminate dirt and debris.
- > Once the arms have been cleaned and dried completely, you can spray the joints with a dry silicone lubricant.

## CAREFREE FREEDOM 12V AWNINGS

Streamlined and easy to operate, Carefree have released the Freedom 12V box awning that mounts onto the side of your RV. By utilising the button installed inside your RV, you can open and retract the awning. Whilst opening the awning, the support arms (located in the lead bar) can be unfolded once it is at a comfortable and easy-to-reach height. The Freedom's support arms are adjustable by means of flip lock controls. To retract the awning, simply fold support arms back into the lead bar and press the button; the awning case closes and locks itself, so you are ready to continue your journey. The Freedom 12V awnings are housed in an attractive white aluminium casing and are available in two canopy colours.

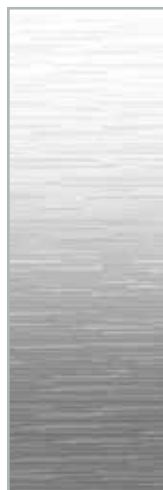

Use the table below to determine which Freedom 12V awning is best for you:

Awning Size	Canopy Width	Canopy Extension
Freedom 2.5m	2.4m	2m
Freedom 3m	2.8m	2.4m
Freedom 3.5m	3.3m	2.4m
Freedom 4m	3.8m	2.4m
Freedom 4.5m	4.3m	2.4m
Box Dimensions: 14.5H x 9.1D (cm)		
Power Requirements: 12V, 15A		



**200-38100**

**FREEDOM 2.5M SILVER SHALE FADE**

**200-38110**

**FREEDOM 3.0M SILVER SHALE FADE**

**200-38120**

**FREEDOM 3.5M SILVER SHALE FADE**

**200-38130**

**FREEDOM 4.0M SILVER SHALE FADE**

**200-38140**

**FREEDOM 4.5M SILVER SHALE FADE**



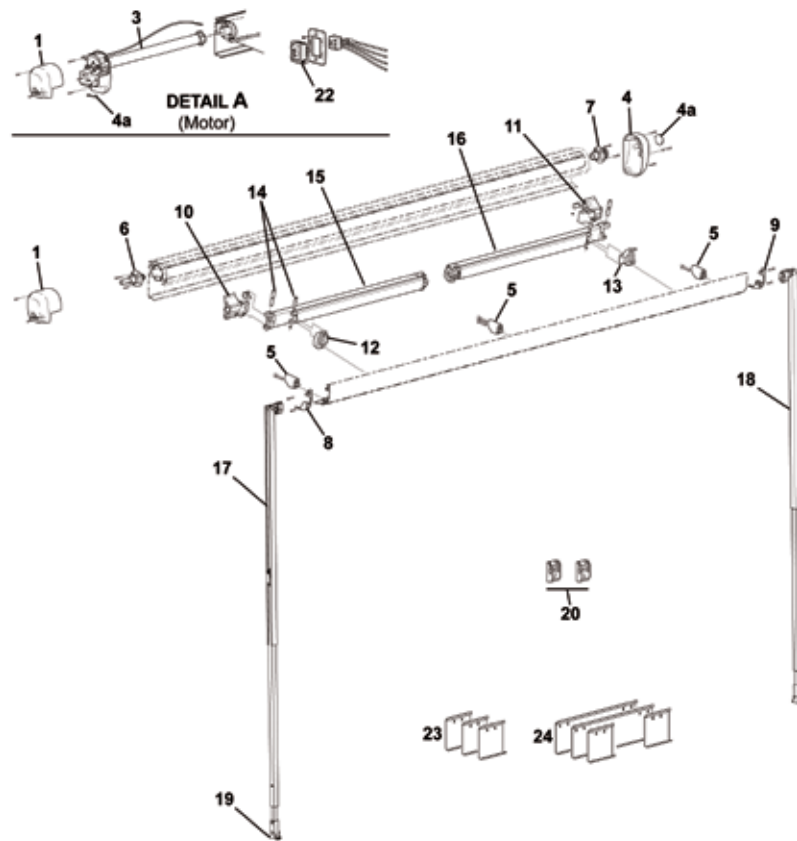

No.	Carefree Part No.	Coast Part No.	Description
6	R001618WHT	<b>200-38502</b>	Freedom L/H End Cap Top White
3	R001637WHT	<b>200-38500</b>	Freedom L/H Motor Assy White
4	R001620WHT	<b>200-38504</b>	Freedom R/H End Cap White
4a	R040792-005	<b>200-38506</b>	Freedom Plug White
5	R001621	<b>200-38508</b>	Freedom Ramp Kit Lead Rail
6	R001622	<b>200-38510</b>	Freedom L/H Roller Tube End Plug
7	R001623	<b>200-38512</b>	Freedom R/H Roller Tube End Plug
8	R001624WHT	<b>200-38514</b>	Freedom L/H End Plate Lead Rail White
9	R001625WHT	<b>200-38516</b>	Freedom R/H End Plate Lead Rail White
10	R001626	<b>200-38518</b>	Freedom L/H Knuckle Assy Case
11	R001627	<b>200-38520</b>	Freedom R/H Knuckle Assy Case
12	R001628	<b>200-38522</b>	Freedom L/H Assy Pivot
13	R001629	<b>200-38524</b>	Freedom R/H Assy Pivot
14	R001630	<b>200-38526</b>	Freedom Hardware Pack Arm Attach - 1 Arm
15	R012530-TB76L	<b>200-38528</b>	Freedom L/H Spring Arm Assy - Used with 2.57m

	R012530-TB94L	<b>200-38532</b>	Freedom L/H Spring Arm Assy - Used with 3.0m & Up
16	R012530-TB76R	<b>200-38530</b>	Freedom R/H Spring Arm Assy - Used with 2.57m
	R012530-TB94R	<b>200-38534</b>	Freedom R/H Spring Arm Assy - Used with 3.0m & Up
17	R001654-001	<b>200-38536</b>	Freedom L/H Vertical Support Leg - Used with 2.44m & 2.57m
	R001654-002	<b>200-38540</b>	Freedom L/H Vertical Support Leg - Used with 3.0m & Up
18	R001654-101	<b>200-38538</b>	Freedom R/H Vertical Support Leg - Used with 2.44m & 2.57m
	R001654-102	<b>200-38542</b>	Freedom R/H Vertical Support Leg - Used with 3.0m & Up
19	R00394	<b>200-38544</b>	Freedom Carport Foot
20	R019283-005	<b>200-38546</b>	Freedom Kit Bottom Bracket White
22	R001605	<b>200-38548</b>	Freedom Switch Kit
23	R019311-001	<b>200-38550</b>	Freedom Hardware Pack 2.43m to 4.0m
24	R019311-003	<b>200-38552</b>	Freedom Hardware Pack 4.50m to 5.0m

# STABILUS GAS STRUTS

## STABILUS GAS STRUTS

LIFT-O-MAT gas springs are non-locking gas springs. They are used whenever components must be brought conveniently into a defined end position. A LIFT-O-MAT can control the extension force and damping action depending on the function, ensuring user-friendly motion sequences.

### Advantages and Properties

- > Optimised weight compensation during liftings, lowering, opening and closing actions
- > Broad range of sizes and force variants available as standard products.
- > Flat Spring characteristic curve; i.e., low force increase, even with high forces and large strokes
- > Choice of linear, progressive or decreasing spring characteristic curves
- > Compact form factor for installation in small spaces
- > Large variety of end fittings for efficient assembly
- > Dampened adjustment motion over defined ranges or continuously
- > Extension speed control possible

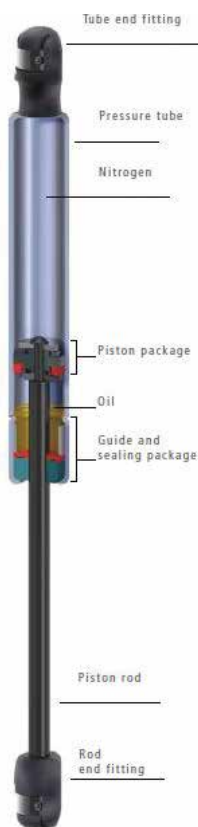

Part Number	Description
250-00202	STABILUS Gas Strut 315.5mm/50N/120mm Stroke (C5719/No Ball-Studs Inc)
250-00204	STABILUS Gas Strut 315.5mm/60N/120mm Stroke (C5719A/No Ball-Studs Inc)
250-00206	STABILUS Gas Strut 315.5mm/150N/120mm Stroke (C5720/No Ball-Studs Inc)
250-00208	STABILUS Gas Strut 315.5mm/100N/120mm Stroke (C5720B/No Ball-Studs Inc)
250-00210	STABILUS Gas Strut 315.5mm/250N/120mm Stroke (C5724/No Ball-Studs Inc)
250-00212	STABILUS Gas Strut 415mm/175N/150mm Stroke (C5718C/No Ball-Studs Inc)
250-00214	STABILUS Gas Strut (Eyelet) 455mm/200N/180mm Stroke (C2705D/No Ball-Studs Inc)
250-00216	STABILUS Gas Strut 485mm/250N/200mm Stroke (C5714/No Ball-Studs Inc)
250-00218	STABILUS Gas Strut 485mm/400N/200mm Stroke (C5714A/No Ball-Studs Inc)
250-00220	STABILUS Gas Strut 485mm/125N/200mm Stroke (C5715B/No Ball-Studs Inc)
250-00222	STABILUS Gas Strut 485mm/600N/200mm Stroke (C5715C/No Ball-Studs Inc)
250-00224	STABILUS Gas Strut 485mm/200N/200mm Stroke (C5718/No Ball-Studs Inc)
250-00226	STABILUS Gas Strut 485mm/280N/200mm Stroke (C5724A/No Ball-Studs Inc)
250-00228	STABILUS Gas Strut 501mm/100N/200mm Stroke (C5718D/No Ball-Studs Inc)
250-00230	STABILUS Gas Strut 525mm/200N/220mm Stroke (C5718A/No Ball-Studs Inc)
250-00232	STABILUS Gas Strut 525mm/150N/220mm Stroke (C5720A/No Ball-Studs Inc)
250-00234	STABILUS Gas Strut 585mm/300N/250mm Stroke (C5703Z/No Ball-Studs Inc)
250-00236	STABILUS Gas Strut 585mm/250N/250mm Stroke (C5723/No Ball-Studs Inc)
250-00238	STABILUS Gas Strut 825mm/330N/354mm Stroke (C5702/No Ball-Studs Inc)
250-00240	STABILUS Gas Strut 825mm/240N/354mm Stroke (C5703/No Ball-Studs Inc)
250-00242	STABILUS Gas Strut 825mm/290N/354mm Stroke (C5704/No Ball-Studs Inc)
250-00244	STABILUS Gas Strut 825mm/435N/354mm Stroke (C5715/No Ball-Studs Inc)
250-00246	STABILUS Gas Strut 825mm/500N/354mm Stroke (C5715A/No Ball-Studs Inc)
250-00248	STABILUS Gas Strut 825mm/600N/354mm Stroke (C5728/No Ball-Studs Inc)
250-00250	STABILUS Gas Strut 825mm/630N/354mm Stroke (C5741/No Ball-Studs Inc)
250-00252	STABILUS Gas Strut 902.5mm/525N/400mm Stroke (C5710E/No Ball-Studs Inc)
250-00254	STABILUS Gas Strut 195mm/200N/60mm Stroke (C5718B/No Ball-Studs Inc)
250-00256	STABILUS Gas Strut 195.5mm/350N/60mm Stroke (C5722/No Ball-Studs Inc)
250-00258	STABILUS Gas Strut 375mm/50N/150mm Stroke (C5725/No Ball-Studs Inc)
250-00260	STABILUS Gas Strut 825mm/700N/354mm Stroke (C5727/No Ball-Studs Inc)

# CARAVAN BED FRAMES

## CARAVAN BED FRAMES



Made from lightweight aluminium (which is 30% lighter than a standard steel bed frame), the Coast Bed Frames are designed in Australia. Their frame is powder coated in a neutral colour (stone beige) to compliment any RVs interior. Slats are made of sturdy European birch timber which is not a hard wood; it therefore offers more flexibility, making it more resilient to breaks. The slats have a textured finish on the side that makes contact with an applied mattress – this reduces shifting caused by movement. The slats are attached to the frame by means of rubber boots which are more flexible than the polypropylene alternative (as harder plastics tend to crack and split over time due to movement). Comes with a 1 year manufacturer's warranty on the frame.

### 250-00300 CARAVAN BED FRAME ALUMINIUM PRINCE SPLIT HEAD

#### Specifications

Dimensions (open): 1450W x 1580L (mm)

Dimensions (closed): 1450W x 1400L (mm)

Weight: 13.5kg

### 250-00302 CARAVAN BED FRAME ALUMINIUM DOUBLE SPLIT HEAD

#### Specifications

Dimensions (open): 1325W x 1580L (mm)

Dimensions (closed): 1325W x 1400L (mm)

Weight: 12.5kg



## CANOPY LIFT MECHANISMS

## 150-00200

## POP TOP INSERT BOWS

These curved bows slide into most pop top vinyl sleeves to ensure the vinyl or canvas folds in when the roof is lowered. They extend up to 255mm in length.



## CANOPY LIFT MECHANISMS (FLAT)

A flat 'scissor' style canopy lifter which raises the roof on a pop-top or campervan. They are made of a steel track on the bottom and top sections, as well as two flat steel lengths that form an 'X' and pivot in the centre. Available in two lengths.

## 250-00500

## CANOPY LIFT MECHANISM STANDARD TENSION SPRING

## Specifications

Width: 900mm

Lift Height: 685mm

Weight Rating: 40kg



## 250-00510

## CANOPY LIFT MECHANISM STANDARD TENSION SPRING

## Specifications

Width: 700mm

Lift Height: 560mm

Weight Rating: 35kg



## 250-00520

## CANOPY LIFT MECHANISM (TUBULAR)

A tubular 'scissor' style canopy lifter which raises the roof on a pop-top or campervan. It is made of a steel track on the bottom and top sections, as well as two tubular steel lengths that form an 'X' and pivot in the centre.

## Specifications

Width: 900mm

Lift Height: 685mm



## 250-00530

## CANOPY LIFT MECHANISM 1200MM

A flat 'scissor' style canopy lifter which raises the roof on a pop-top or campervan. It is made of a steel track on the bottom and top sections, as well as two steel lengths that form an 'X' and pivot in the centre.

## Specifications

Width: 1200mm

Lift Height: 990mm

Weight Rating: 35kg



## CANOPY EASY LIFT ARMS

Canopy easy lift arms (pair), made from 16mm square tube steel with a wall thickness of 1.2mm.

- > White powder coat finish

- > Sold per pair

## 250-00546

## CANOPY EASY LIFT ARMS – SMALL



## 250-00548

## CANOPY EASY LIFT ARMS – LARGE

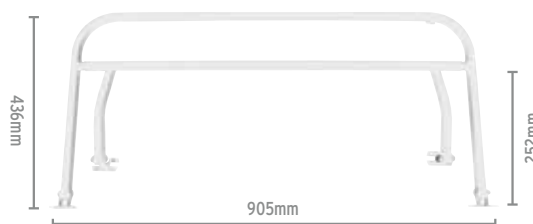

## 250-00544

## CANOPY EASY LIFT ARMS – SILVER LATCH



## POP-TOP &amp; CAMPER PARTS

## ROOF CLAMP FOR POP TOPS

**250-00552****ROOF CLAMP FOR POP TOP  
- WHITE**

(2 Part kit)

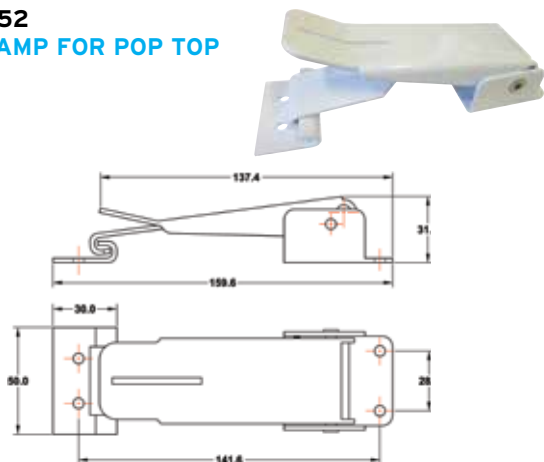
**250-00554****ROOF CLAMP WITH J HOOK  
FOR POP-TOP BLACK**

Essential for all pop tops, these roof clamps secure the roof in the lowered position whilst in travel. Comes as a 2-part kit, a clamp & small J bracket.

**250-00560****J HOOK FOR WHITE  
POP-TOP CLAMP****250-00602****ROOF CLAMP FOR POP-TOP  
- SILVER**

(2 Part kit)

**250-00610****J HOOK FOR SILVER POP  
TOP CLAMP****250-00620****LOCKABLE ROOF CLAMP FOR  
POP-TOP - SILVER**

Allows you to lock your pop top roof in the closed position by using a padlock. (Padlocks are not included).

**200-08038****COAST POP TOP SUPPORT - WHITE**

Give your pop top roof support when it is in the open position. Its telescopic mechanism makes it easy to use, and once the appropriate height is achieved, a simple twist locks it in position. Made from an aluminium tube with rubber caps on each end for a

**Specifications**

Closed Length: 34cm

Max Open Length: 50cm

**250-03000****3 STAGE CAMPER LIFTER WITHOUT WINGS**

Once you have successfully opened your Jayco camper trailer these lifters act as a support to keep your camper trailer in the 'open' position.

**Specifications**

Compacted ext: 770mm

Maximum ext: 2047mm

**250-03100****COAST CAMPER ROOF SUPPORT POLE**

Coast Camper Roof Support Poles are designed to provide additional support for your camper's roof.

Perfect for when your roof is up for long periods of time or if you have added additional load to your roof such as an awning. This product has the following great features:

- > Made from white powder coated lightweight aluminium
- > Rubber end caps for a non-slip fit
- > Can be trimmed down to suit a range of RVs.

**Specifications**

Length: 1500mm

Width: 22mm

Length with Rubber End Caps: 1525mm

Rubber End Cap Width: 35mm

**250-03009****CAMPER LIFTER  
CHANNEL DOOR**

Door and surround to suit Jayco camper lifter channels.



## ALUMINIUM EXTRUSION

**250-03010****PUSH RODS 66"**

These strong, flexible push rods guide the roof of your camper trailer upwards as you wind the crank. They help to push the lifter arm up.

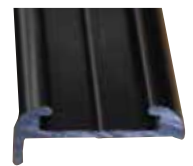
**250-02008****TRULINE FLAT ALUMINIUM  
BLACK 31MM X 4.8M****PLASTIC BED SADDLES****250-03020****PLASTIC BED  
SADDLE TO  
SUIT CAMPER****250-02010****TRULINE ALUMINIUM WHITE  
(J MOULD - NARROW)  
22MM X 4.8M****250-03022****PLASTIC  
BED SADDLE  
TO SUIT  
EXPANDA****250-02012****TRULINE ALUMINIUM  
BLACK (J MOULD -  
NARROW) 22MM X 4.8M****TRULINE ALUMINIUM****250-02000****TRULINE ALUMINIUM WHITE 5M**

Also known as Millard Series 80 Aluminium. This is a powder coated aluminium edging used to seal the joints of the exterior of your RV e.g. where the side wall meets the roof or the rear panel. (Has a 25mm lip to cover the roof or front/ rear).

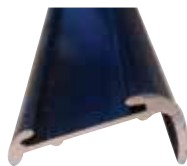
**250-02014****TRULINE FLAT ALUMINIUM  
WHITE (NARROW)  
22MM X 4.8M****250-02002****TRULINE ALUMINIUM  
CUSTOM MATT BLACK 5M****250-02016****TRULINE FLAT ALUMINIUM  
BLACK (NARROW)  
22MM X 4.8M****MOULD INSERT FOR 22MM TRULINE**

Used mostly in the manufacturing process to cover external screw points and give an overall neater appearance. Available with an 18mm width.

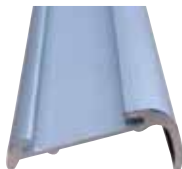
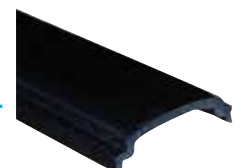
**250-02004****TRULINE CLEAR ANODISED  
5M****250-02126****WHITE MOULD INSERT 100M ROLL****250-02136****WHITE MOULD INSERT 300M ROLL****250-02006****TRULINE FLAT ALUMINIUM  
WHITE 31MM X 4.8M****250-02127****BLACK MOULD INSERT 100M ROLL****250-02137****BLACK MOULD INSERT 300M ROLL**

## ALUMINIUM EXTRUSION

## MOULD INSERT FOR 31MM TRULINE

Fits inside the Truline Aluminium to cover up any unsightly screws.

**250-02128**  
WHITE MOULD INSERT  
100M ROLL



**250-02138**  
WHITE MOULD INSERT  
250M ROLL

**250-02130**  
BLACK MOULD INSERT  
100M ROLL



**250-02140**  
BLACK MOULD INSERT  
250M ROLL

## SAILTRACK

A solution to fixing one end of your roll out awning to the wall of your RV or the roof of your pop top. Alternatively, mount these vertically onto the walls of your RV enabling you to install an annexe room. Drilling is required to attach to the wall of the RV. Comes in two colours.

**200-08100**  
SAILTRACK SINGLE SIDED  
6M MILL FINISH

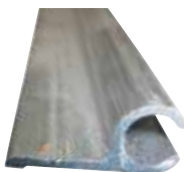

**200-08102**  
SAILTRACK DOUBLE  
SIDED 6M MILL FINISH



**200-08104**  
SAILTRACK SINGLE SIDED  
6M WHITE



**200-08105**  
SAILTRACK SINGLE SIDED  
6M BLACK



**200-08106**  
SAILTRACK DOUBLE  
SIDED 6M WHITE



**200-08107**  
SAILTRACK DOUBLE  
SIDED 6M BLACK



**200-08110**  
SAILTRACK SINGLE SIDED  
4.3M WHITE



**200-08112**  
SAILTRACK DOUBLE  
SIDED 4.3M WHITE



**200-08129**  
TOP FIX CURTAIN TRACK  
5M (MILL FINISH)

An anodised aluminium curtain track that comes pre drilled. Runners are not included.

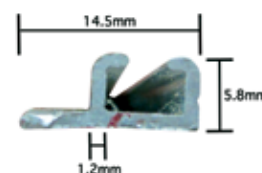

## ALUMINIUM EXTRUSION

## COAST ALUMINIUM CLADDING

COAST CP10  
- DEEP VIOLETONE

## Specifications

Sheet Thickness: 0.55mm

Tolerance: 3005, H44 temper

Top Finish: Polyester paint (25um thick)  
with and 80% applied.

Bottom Finish: Grey primer paint (5-7um thick)

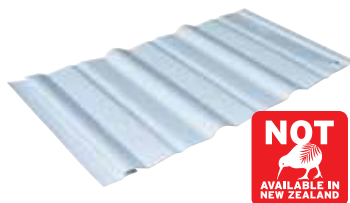

Part Number	Description
250-01130	ALUMINIUM SIDE CLADDING 6.1 X 0.315 Coast CP10 DEEP VIOLETONE WHITE.NO Plastic Film
250-01140	ALUMINIUM SIDE CLADDING 7.3 X 0.315 Coast CP10 DEEP VIOLETONE WHITE.NO Plastic Film
250-01150	ALUMINIUM SIDE CLADDING 8.0 X 0.315 Coast CP10 DEEP VIOLETONE WHITE.NO Plastic Film
250-01160	ALUMINIUM SIDE CLADDING 7.3 X 0.315 Coast CP10 CRYSTAL SILVER. NO Plastic Film

COAST CPSF10  
- SHALLOW VIOLETONE

Part Number	Description
250-01230	ALUMINIUM SIDE CLADDING 6.1 X 0.315 Coast CPSF10 SHALLOW PROFILE V/WHITE.NO Plastic Film
250-01240	ALUMINIUM SIDE CLADDING 7.3 X 0.315 Coast CPSF10 SHALLOW PROFILE V/WHITE.NO Plastic Film
250-01250	ALUMINIUM SIDE CLADDING 7.3 X 0.315 Coast CPSF10 SHALLOW PROFILE V/WHITE.NO Plastic Film
250-01260	ALUMINIUM SIDE CLADDING 7.3 X 0.315 Coast CPSF10 CRYSTAL SILVER. NO Plastic Film

## COAST NF10



Part Number	Description
250-01270	ALUMINIUM SIDE CLADDING 7.3 X 0.315 Coast NF10 WHITE. NO Plastic Film
250-01272	ALUMINIUM SIDE CLADDING 8.0 X 0.315 Coast NF10 WHITE. NO Plastic Film
250-01280	ALUMINIUM SIDE CLADDING 7.3 X 0.315 Coast NF10 SILVER GLASS. NO Plastic Film
250-01282	ALUMINIUM SIDE CLADDING 8.0 X 0.315 Coast NF10 SILVER GLASS. NO Plastic Film

## COAST CP48



Part Number	Description
250-01320	ALUMINIUM ROOF SHEETING. 2.44 x 1.22 MT. Coast CP48. V/ WHITE.NO Plastic Film
250-01350	ALUMINIUM ROOF SHEETING. 2.44m x 1.22m STUCCO Coast CP48 no plastic film WHITE

## COAST CPF3



Part Number	Description
250-01330	ALUMINIUM ROOF SHEETING. 2.44 x 1.22 MT. Coast CPF3. V/ WHITE.NO Plastic Film
250-01360	ALUMINIUM ROOF SHEETING. 2.44m x 1.22m STUCCO Coast CPF3 no plastic film WHITE

## TAPE FOAM PVC SEALING

This general purpose foam tape is manufactured for use in applications requiring positive seals on irregular surfaces or when flex and conformability to tight radius curves are critical considerations.

- > Low density foam is easy to compress and conformable, but is still strong and resilient
- > Insulates against temperature, sound and vibration
- > Formulated from durable Poly Vinyl Chloride (PVC) for long service life.
- > Closed cell structure completely seals out air, moisture, light and dust when compressed at least 30%.



**250-02500**  
GREY 6.4MM THICK  
X 12MM X 15.2M

**250-02501**  
BLACK 6.4MM THICK  
X 12MM X 15.2M

**250-02502**  
GREY 9.5MM THICK  
X 12MM X 7.0M

**250-02503**  
BLACK 9.5MM THICK  
X 12MM X 7M

**250-02504**  
GREY 12.7MM THICK  
X 12MM X 7.0M

**250-02505**  
BLACK 12.7MM THICK  
X 12MM X 7M

**250-02506**  
GREY 6.4MM THICK  
X 18MM X 15.2M

**250-02507**  
BLACK 6.4MM THICK  
X 18MM X 15.2M

**250-02508**  
GREY 9.54MM THICK  
X 18MM X 7.0M

**250-02509**  
BLACK 9.5MM THICK  
X 18MM X 7M

**250-02510**  
GREY 12.7MM THICK  
X 18MM X 7.0M

**250-02511**  
BLACK 12.7MM THICK  
X 18MM X 7M



# LIPPERT SLIDE OUT ROOMS

## THE LIPPERT RANGE



Exclusively available through Coast to Coast, Lippert present their ready-to-use in Wall Slide Out Systems, allowing Australian manufacturers to provide more living space to RV consumers without compromising overall size.

In order to provide greater flexibility, improved aesthetics and pricing, Lippert Slide Out Systems are no longer sold in kits. Individual components can now be ordered to suit your specific requirements and a list of parts and required quantities is now available.

For your convenience it is still possible to order all the components that make up each of the superseded kits. Just let your friendly Coast to Coast sales team know the kit number and quantity required and we'll handle the rest.

### Durable and Corrosion Resistant

Lightweight anodised aluminum resists rust better than systems with chains, cables and exterior mounting brackets.

### More Space

Slide-Out mechanism fits inside the wall cavity leaving significantly more interior space. Other bulky systems require a slide room fascia to cover motor and pulleys.

### Leak Free

The 50/50 power split ensures both slide room sides properly compress seals. Independent side control allows different stroke lengths to compensate for bulb seals setting or wearing down unequally.

### Lightweight

Lightest slide system on the market keeps overall RV weight down.

### No Adjustments

The In-Wall Slide-Out System never needs complicated adjustments.

### Smart Control Technology

Smart system continually monitors motors for safe operation, and stops the slide-out if an issue is detected.

### Specifications

- > Each Slide Out System (per side) consists of: x1 Motor Drive, x2 Drive Gears and x1 Torque Shaft
- > Can be installed on RVs with a wall thickness of 25-38mm
- > Has a manual override function
- > Switch is mounted internally (to move room in or out)

Slide Out Room Kit 1 1478mm-610mm

Slide Out Room Kit 2 1578mm-610mm

Slide Out Room Kit 3 1678mm-610mm

Slide Out Room Kit 4 1478mm-910mm

Slide Out Room Kit 5 1578mm-910mm

Slide Out Room Kit 6 1678mm-910mm

Slide Out Room Kit 7 1978mm-910mm

Slide Out Room Kit 8 1813mm-910mm



## LIPPERT SLIDE OUT ROOMS

CTC P/N	DESCRIPTION	QTY	UNIT	NOTE	D-SEAL METRE
<b>SLIDE OUT H COLUMN AND RACK</b>					
250-05031	Lippert Slide Out H Column and Rack Only. 1478mm-610mm. V000293019		ea	1 per Kit	14
250-05033	Lippert Slide Out H Column and Rack Only. 1578mm-610mm. V000293020		ea		14
250-05035	Lippert Slide Out H Column and Rack Only. 1678mm-610mm. V000293021		ea		15
250-05037	Lippert Slide Out H Column and Rack Only. 1478mm-910mm. V000299431		ea		14
250-05039	Lippert Slide Out H Column and Rack Only. 1578mm-910mm. V000299432		ea		14
250-05041	Lippert Slide Out H Column and Rack Only. 1678mm-910mm. V000299433		ea		15
250-05043	Lippert Slide Out H Column and Rack Only. 1978mm-910mm. V000317788		ea		16
250-05045	Lippert Slide Out H Column and Rack Only. 1813mm-910mm. V000323782		ea		15
250-05047	Lippert Slide Out H Column and Rack Only. 911mm-889mm. V000355073	N/A			
<b>CONTROLLER</b>					
250-05100	Slide Out Room Controller. 211852		ea	1 per Kit	
<b>HARNESS</b>					
250-05152	Lippert Slide Out 20' (6096mm) Harness for Controller to Motor. 229755		ea	2 per Kit	
<b>SWITCH</b>					
250-05156	Switch (40 amp) with 4 Wire Pigtail for Slide-Out. 0187505		ea	1 per Kit	
<b>EXTERIOR T MOLD AND T MOLD COVERS (BLACK/WHITE)</b>					
250-05162	Aluminium T-Mold 1801 15' (4572mm) Black (Hole Punched). 0713833		ea	3 per Kit	
250-05164	Aluminium T-Mold 1801 15' (4572mm) Polar White (Hole Punched). 0713834		ea	3 per Kit	
250-05166	Plastic Corner Cover for Aluminium T-Mold White "700". 0713867		ea	4 per Kit	
250-05168	Plastic Corner Cover for Aluminium T-Mold Black "700". 0713866		ea	6 per Kit	
250-05170	Aluminium Angle 40mm x 25mm x 3mm x2400mm		ea	3 per Kit	
<b>RUBBER SEAL AND CORNER CUP SEAL</b>					
250-05172	Top Double Wiper Seal Black in 15' (4572mm) Length. 0713831		ea	1 per Kit	
250-05174	Bottom Single Wiper Seal Black in 15' (4572mm) Length. 0713836		ea	1 per Kit	
250-05180	Rubber "D" Seal Black (Sold per Metre). 0713835		Metres	Refer to "D-Seal" Column	
250-05176	Bottom Right Hand Corner Cup Seal Black. 0217506		ea	1 per Kit	
250-05178	Bottom Left Hand Corner Cup Seal Black. 0217505		ea	1 per Kit	
<b>FLOOR ROLLER</b>					
250-05158	Slide Out Room Roller & Bracket 26mm. 217900		ea	6 per Kit	



**NOTES**

---

---

---

---

---

---

---

---

---

---

---

---

---

---

---

---

---

---

---

---

---

---

---

---

---

---

---

---

---

---

# SECTION 2

## CAMPING EQUIPMENT

(Product Group - 300)

Camping Accessories	060 - 063
Coast Fire Pits	064
Collapsible Homeware	065
Palm Drinkware and Kitchen Accessories	066 - 070

---

## CAR ACCESSORIES

(Product Group - 350)

Towing Accessories	070 - 074
Towing Mirrors	074 - 076
Brake Controllers	077 - 079
CURT Towing Accessories	079 - 082
Tyre Pressure Monitoring	083 - 084
Lippert Swap Command Kit	085
Quick Fit Bike Racks	086 - 087
Carry Bikes and Accessories	088 - 091
Hayman Reese Hitches	092 - 093
Eaz Lift WDH and Accessories	094 - 097
Tips For Safer Towing	098 - 099
Throttle Controllers	100



## COAST BLUE CAMP FURNITURE

## 300-00910

## COAST BLUE CAMP CHAIR WITH SIDE BAG &amp; TABLE - 120KG RATED

- > Folds down to a compact size for easy storage and carrying.
- > Come with high quality storage bag with carry handles and zips.
- > Features a locking mechanism for safety and stability.
- > Folding side table with cup holder and hanging storage bag.
- > Loading capacity: 120KG.



## Specifications

Dimensions: 54x45x46/92

Frame:  $\Phi$ 22mm, 30x15mm steel tube/powder coating

Material: 600D polyester/PVC coating

## 300-00912

## COAST BLUE PADDED HI-BACKED CHAIR - 120KG RATED

- > 120kgs max loading capacity.
- > Folds down to a compact size for easy storage and carrying.
- > Features a comfortable foam padded seat, headrest and backrest.
- > Fabric covers on aluminium armrest.
- > Lumbar support.
- > Invisible pocket on the top for carry bag storage.
- > Two side pockets.



## Specifications

Dimensions: 65x45x50/95

Frame:  $\Phi$ 22mm steel tube/powder coating Armrest: 55\*22mm Alu/powder coating

Material: 600D polyester/PVC coating

## 300-00920

## COAST BLUE COLLAPSIBLE CAMP CUPBOARD - 30KG RATED

- > Dual sided three-shelf flat folding cupboard.
- > Matt finished cupboard top can be used as a convenient table
- > Quick and easy to assemble in seconds, mesh rear to ventilation.
- > Easily folded into and packing away for carrying and storage.
- > Carry bag included.
- > Loading capacity: 30KG



## Specifications

Dimensions: 84x50x80cm

Frame:  $\Phi$ 19mm Alu. Tube/matt finish

Material: 600D polyester/PVC coating

## 300-00922

## COAST BLUE TAILGATE CAMP TROLLEY - 100KG RATED

- > Multipurpose folding camp trolley with storage pockets
- > Carry all your gear to the camping or picnic spot with ease.
- > Rear of trolley folds down to accommodate oversized items
- > Tailgate doubles as a table with 2 cup holders.
- > Adjustable long handle to pull and direct the trolley with ease.
- > Large, lightweight wheels allow you to navigate almost any terrain.
- > Foldable to compact size for easy carrying and storage.
- > Carry bag included.
- > Loading capacity: 50KG



## Specifications

Dimensions: 98.5x49x58cm

Frame:  $\Phi$ 19mm, 25x12mm, 20x10mm steel tube/powder coating

Material: 600D polyester/PVC coating

## 300-00930

## COAST BLUE CAMP SHOE RACK - ORGANIZER BAG

- > Large hanging storage and organisation rack
- > 10 large storage compartments that are perfect for shoes and other belongings to keep them high and dry.
- > Large carry handle, reinforced eyelets and straps with fasteners for multiple hanging solutions.
- > Full storage compartment covering with dual zippers and storage clips



## Specifications

Dimensions: 86x48x18

Material: 600D polyester/PVC coating

## 300-00932

## COAST BLUE TENT TIDY - VERTICAL ORGANIZER BAG

- > Vertical hanging storage bag for organising your belongings, keeping them clean and safe.
- > 8 small pockets (10w x 14h) 6 medium pockets (15w x 14h) and 2 large pockets (22w x 17h)
- > Reinforced eyelets and looped straps for multiple hanging solutions.



## Specifications

Dimensions: 123x47x15

Material: 600D polyester/PVC coating

## CAMCO CAMPING ESSENTIALS

**300-00100**

### RV COLLAPSIBLE BUCKET

Made from a rugged and watertight material, this bucket is the perfect size for RVing, camping and fishing. With an 11L capacity and opening up to 23.5cm tall, it takes up minimal storage space by folding to a compact 3.5cm when not in use. Comes with a convenient zippered storage bag.



**300-01114**

### FOLDING SHOVEL

Length: 61cm  
Folds to: 24cm



**300-01122**

### TENT PEG PULLER



**300-01100**

### LANTERN HANGER

Helps to keep bugs up and away from your campsite (lantern not included).



**300-01124**

### VINYL TABLECLOTH

Has rounded edges and an easy to clean waterproof surface.  
Dimensions: 132W x 213L (cm)



**300-01108**

### 12 EGG CARRIER



**300-01132**

### CAMCO HAPPY HOUR FLAG

This flag will let your friends know that after a hard day at the RV park, you're ready to relax and enjoy the evening.



**300-01110**

### LAUNDRY REEL

Has 21 feet (6.4m) of laundry line.



**300-01134**

### CAMCO TIPSYP STIX

Holds a variety of beverages and snacks. Beverage holders lock in two ways for standard size beverages. Bonus snack holder holds bowls and plates. Great for outdoor parties and activities.



## COAST TIE DOWN RANGE

## COAST TIE DOWN RANGE

**200-08019****COAST PREMIUM AWNING TIE DOWN KIT**

The ultimate tie down kit to keep your awning safe and secure! It can help prevent damage to your awning caused by high winds and comes with screw-in-pegs that can quickly be driven into the ground with ease thanks to the Power Drill Adaptor Socket.



Includes:

- > 2 x Large Alloy Screw In Peg 300mm
- > 2 x ABS Guy Rope Holders
- > 1 x Alloy Screw In Peg Power Drill Adaptor Socket 17mm
- > 2 x Reflective Glow Guy Rope with Spring and Runner
- > 2 x Tie Down Awning Clamps Stainless Steel

**300-01200****LARGE ALLOY SCREW IN PEG WITH ABS GUYROPE HOLDER CLIP**

- > The screw action grips into the soil for a safe and secure guy rope tie down point
- > Comes complete with a guy rope holder clip to tie down your awning quickly and easily
- > Designed to suit the Power Drill Adaptor Socket (sold separately) that allows the screw to be quickly driven into the ground with ease

**300-01209****ALLOY SCREW IN PEG POWER DRILL ADAPTOR SOCKET**

- > Designed to suit large alloy screw in pegs
- > Power Drill Adaptor Socket 17mm

**300-01210****STD GUY ROPE SPRUNG WITH ALUM HANDLE - 2.6M**

Complete with aluminium handle and heavy-duty spring, these guy ropes will keep the tension on awnings, gazebos, tent poles etc.

- > 6mm rope 2.6m long
- > Heavy duty spring
- > Aluminium runner

**300-01212****REFLECTIVE GLOW GUY ROPE SPRUNG WITH ALUM HANDLE - 3.5M**

No more tripping and stumbling around the campsite at night with this reflective glow in the dark guy rope.

Complete with aluminium handle and heavy-duty spring, these guy ropes will keep the tension on awnings, gazebos, tent poles etc.

- > 6mm Reflective glow in the dark rope 3.5m long
- > Heavy duty spring
- > Aluminium runner

**300-01220****PAIR OF ROLL OUT AWNING TIE DOWN CLAMPS**

Protect your roll out awning in all conditions with these stainless-steel tie downs. Simply fit over each end of the roller and locate the rear of the awning groove, add your guy ropes to the loops and secure to the ground.



## GLO-X POWERLESS ILLUMINATION

Glo-X offers 'powerless illumination' and has been developed using the latest in light recycling technology. Due to its unique properties, Glo-X is ideal for use in areas where power is not readily available, but illumination is required.

**300-01451****GLO-X 60MM ROUND MARKER**

Glo-X Round Markers can be used for a wide range of applications including trailers, caravans, driveways, night guidance, fishing, boating, camping, post marking and safety markings. Easily attachable by a screw, rivet or bonding.



The Round Markers charge quickly with any form of powered or natural light and then illuminate for 10+ hours depending on light conditions. Applied to stairs or hidden obstacles during low light periods or in the event of a power failure. A Round Marker can add a personal touch of illumination to many products that will set you apart from others.

FULL LUMINANCE EFFECT IS BEST ACHIEVED IN TOTAL DARKNESS.

**Applications**

- > Trailer
- > Guy rope tent peg marker
- > Driveway / letterbox marker
- > Night guidance
- > Fishing, boating
- > Camping
- > Post marking
- > Hazard safety marking

**Specifications**

Diameter: 60mm

Thickness: 4mm

Centre Hold Diameter: 5mm



# GLO-X POWERLESS ILLUMINATION

## 300-01456

### GLO-X 90 X 55MM SIGN TILE MARKER

Glo-X Sign Marker is easily locatable and encourages way finding and identification in low light situations. The size of a business card, this marker can be personally formatted into any symbol, wording or signage. Can be used for a wide range of applications including caravans, trailers, driveways, night guidance, fishing, boating, camping, emergency and personal identification, instructions and safety markings. The Sign Marker comes with a black marker pen to enable you to personalise the use and application of the signs.

FULL LUMINANCE EFFECT IS BEST ACHIEVED IN TOTAL DARKNESS.

#### Applications

- > Address and name marking
- > Emergency equipment location marking
- > Personal notes
- > Hazard awareness
- > Preventative signage



#### Specifications

Dimensions: 90 x 55mm  
Thickness: 2.5mm

## 300-01457

### GLO-X 42MM ZIP MARKER 4PK

Glo-X Zip Marker will charge quickly with any form of powered or natural light and then illuminate for 10+ hours depending on light conditions.

Glo-X Zip Markers can easily connect to an existing zip. With a wide range of applications available including tents, backpacks, sleeping bags and clothing, this zip marker is essential for use when locating a zipper in a low level light situation as well as being a powerless long lasting personal safety indicator. The Glo-X Zip Marker will charge quickly with any form of powered or natural light and then illuminate for 10+ hours depending on light conditions.

FULL LUMINANCE EFFECT IS BEST ACHIEVED IN TOTAL DARKNESS.

#### Applications

- > Easily clipped onto an existing zip
- > Ideal for use when locating tent zips
- > Perfect for backpacks, clothing and sleeping bag zips



#### Specifications

Length: 40mm  
Height: 10mm  
Thickness: 5mm

## COAST CAMP N COOLER

## 300-06000

### COAST CAMP N COOLER

The perfect way to store your cold goods when free camping, at the beach or picnicking. The 30L cooler includes dual folding wing tables to hold food and drink, two convenient mini-camp chairs that clip under the table wings and folding carry handles and integrated wheels for easy maneuvering



#### Features

- > Portable 30L cooler with removable storage tray
- > Folding carry handles and wheels for ease of movement
- > Dual folding wing tables with folding support legs
- > Two folding mini-camp chairs that clip under table wings for easy storage.

#### Specifications

Folded Size: (L)55cm x (W)37cm x (H)41cm  
Extension Size: (L)100cm x (W)55cm x (H)41cm  
Chair Weight Rating: 89kg  
Chair Size: (H)26cm x (W)24cm x (D)22cm  
Weight: 9kg

## COAST FIRE PITS



Enjoy the cooler weather with the Coast to Coast Firepit. This portable steel firepit folds up for easy storage and allows you to setup a safe and cosy campfire in no time at all. Assembly requires no tools and takes just seconds, so you can enjoy the warmth of a fire without the hassle.

Made from 3mm BlueScope steel it comes standard with a 1.6mm Galvanised ember tray, optional grill and hot plate also available. The Coast Firepit is CNC Laser cut to precision for a perfect press fit assembly in seconds.

**Features**

- > Made from 3mm BlueScope steel
- > Perfect for the campsite and backyard
- > Laser cut carry handles
- > 1.6mm Galvanised ember tray
- > Assembly in seconds
- > Folds up for easy storage
- > Optional grill and hot plate also available
- > Australian Made

**300-06001**

**COAST STEEL PORTABLE 400MM FIREPIT & EMBER TRAY KIT**

**300-06004**

**COAST STEEL GRILL PLATE T/S 400MM FIREPIT**

**300-06013**

**COAST STEEL PORTABLE 600MM FIREPIT & EMBER TRAY KIT**

**300-06014**

**COAST STEEL GRILL PLATE T/S 600MM FIREPIT**



# COLLAPSIBLE HOMEWARE

## TRAVELLERS TWIN PET BOWL

These travellers pet bowls feature folding legs that lock for space saving storage while on the road and height adjustment when in use.

The frame is made of ABS plastic, the bowls are removable stainless steel and the feet are silicone for grip. The top surface features a handy design that prevents food from spilling over or can be filled with water to create a moat keeping ants from reaching the bowls.

### Specifications

Dimensions: (L)370mm x (W)195mm x (H)54mm (folded)

Bowl diameter ea: 140mm x (H)40mm (500ml)

Adjustable Height: 54 to 115mm

Weight: 0.78kg

### 300-06100

TRAVELLERS TWIN PET BOWL  
- HEIGHT ADJUSTABLE -  
BLACK



### 300-06104

TRAVELLERS TWIN PET  
BOWL - HEIGHT ADJUSTABLE  
- GREY



## COLLAPSIBLE HOMEWARE

### 300-02820

COLLAPSIBLE COAST DISH  
DRAINER

Folding dish rack, food grade.

This dish drainer is ideal for all your kitchen straining tasks and its collapsible nature allows for easy, space saving.

### Specifications

Dimensions: 368 x 317 x 127 mm



## POLYSAFE DRINKWARE

Polysafe drinkware is guaranteed not to crack or shatter, is microwave, dishwasher and campsite safe and has a comfortable drinking lip. An economical solution in a classic design.

**300-03000**  
**VINO BLANCO GOBLET (250ML)**

**300-03014**  
**SPARKLING FLUTE (180ML)**

**300-03016**  
**COLINS TUMBLER (270ML)**

**300-03002**  
**CHAMPAGNE FLUTE (170ML)**

**300-03018**  
**COLINS TUMBLER (335ML)**

**300-03004**  
**JASPER HIGHBALL TUMBLER (425ML)**

**300-03020**  
**COLINS TUMBLER (425ML)**

**300-03006**  
**ESPRESSO CUP (250ML)**

**300-03008**  
**JASPER HIGHBALL TUMBLER (285ML)**

**300-03010**  
**DOUBLE JASPER TUMBLER (375ML)**

# PALM DRINKWARE

## PALM PRODUCTS

### Marc Newson Tritan Drinkware Collection

The Marc Newson Tritan Drinkware Collection is the result of a collaboration between designer Marc Newson, described as the most influential designer of his generation and the engineering and production skills of Robert Wilson and his team at Palm Products.

Their objective was to create the world's finest range of unbreakable drinkware which boasts the following features:

- > Guaranteed unbreakable and dishwasher safe for 10 years in private use and one year in commercial use.
- > Superior dishwasher stability - the drinkware will not crack, break, scratch or go grey and will resist staining.
- > Non-slip base aids stability and acts as a coaster, protecting surfaces.
- > Stable, shorter shapes with well-weighted, wide bases.
- > Tumblers stack securely, saving space and preventing damage.

**300-03600**  
WHISKY CUP WITH CLEAR BASE 285ML

**300-03602**  
HIGHBALL CUP WITH CLEAR BASE 425ML

**300-03604**  
WINE GLASS WITH CLEAR BASE 300ML

**300-03606**  
FLUTE GLASS WITH CLEAR BASE 180ML



**300-03608**  
WHISKY CUP WITH WHITE NONSLIP BASE 285ML

**300-03610**  
HIGHBALL CUP WITH WHITE NONSLIP BASE 425ML

**300-03612**  
WINE GLASS WITH WHITE NONSLIP BASE 300ML

**300-03614**  
FLUTE GLASS WITH WHITE NONSLIP BASE 180ML



**300-03616**  
WHISKY CUP WITH BLACK NONSLIP BASE 285ML

**300-03618**  
HIGHBALL CUP WITH BLACK NONSLIP BASE 425ML

**300-03620**  
WINE GLASS WITH BLACK NONSLIP BASE 300ML

**300-03622**  
FLUTE GLASS WITH BLACK NONSLIP BASE 180ML



**300-03624**  
WHISKY CUP WITH BLUE NONSLIP BASE 285ML

**300-03626**  
HIGHBALL CUP WITH BLUE NONSLIP BASE 425ML

**300-03628**  
WINE GLASS WITH BLUE NONSLIP BASE 300ML

**300-03630**  
FLUTE GLASS WITH BLUE NONSLIP BASE 180ML



**300-03632**  
WHISKY CUP WITH GREEN GLOW IN DARK NONSLIP BASE 285ML

**300-03634**  
HIGHBALL CUP WITH GREEN GLOW IN DARK NONSLIP BASE 425ML

**300-03636**  
WINE GLASS GREEN WITH GLOW IN DARK NONSLIP BASE 300ML

**300-03638**  
FLUTE GLASS WITH GREEN GLOW IN DARK NONSLIP BASE 180ML



## PALM KITCHEN ACCESSORIES

**300-03640**

WHISKY CUP WITH VIVID BLUE NONSLIP BASE 285ML

**300-03642**

HIGHBALL CUP WITH VIVID BLUE NONSLIP BASE 425ML

**300-03644**

WINE GLASS WITH VIVID BLUE NONSLIP BASE 300ML

**300-03646**

FLUTE GLASS WITH VIVID BLUE NONSLIP BASE 180ML

**300-03648**

WHISKY CUP WITH CADMIUM ORANGE NONSLIP BASE 285ML

**300-03650**

HIGHBALL CUP WITH CADMIUM ORANGE NONSLIP BASE 425ML

**300-03652**

WINE GLASS WITH CADMIUM ORANGE NONSLIP BASE 300ML

**300-03654**

FLUTE GLASS WITH CADMIUM ORANGE NONSLIP BASE 180ML



## SORONA PLATE AND BOWL RANGE

Sorona plates and bowls are guaranteed unbreakable in normal use. They are dishwasher and microwave safe as well as scratch and stain resistant. The collection stacks securely and efficiently for transport and storage. The sizes fit in typical galleys and RVs and are a suitable size for outdoor use.

- > The materials used are able to withstand dishwasher temperatures and chemicals.
- > Microwave Safe for Reheating
- > The tough surface is highly scratch and stain resistant.
- > High quality, safe, approved for food contact and sustainable.

**300-03656**

BOWL WITH BLACK NONSLIP BASE 15CM

**300-03658**

MEDIUM PLATE WITH BLACK NONSLIP BASE 21CM

**300-03660**

LARGE PLATE WITH BLACK NONSLIP BASE 25CM

**300-03662**

BOWL WITH NAVY NONSLIP BASE 15CM

**300-03664**

MEDIUM PLATE WITH NAVY NONSLIP BASE 21CM

**300-03666**

LARGE PLATE WITH NAVY NONSLIP BASE 25CM

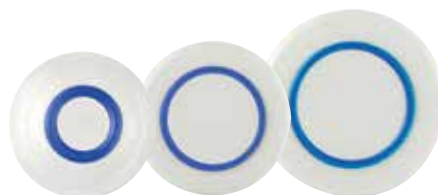
**300-03668**

BOWL WITH VIVID BLUE NONSLIP BASE 15CM

**300-03670**

MEDIUM PLATE WITH VIVID BLUE NONSLIP BASE 21CM

**300-03672**

LARGE PLATE WITH VIVID BLUE NONSLIP BASE 25CM



**300-03674**  
BOWL WITH ORANGE NONSLIP BASE 15CM

**300-03676**  
MEDIUM PLATE WITH ORANGE NONSLIP BASE 21CM

**300-03678**  
LARGE PLATE WITH ORANGE NONSLIP BASE 25CM



## THE PALM CAFFE CUP

The Palm Caffe Cup has a beautiful, tactile design and many distinctive features:

- > A leak-proof lid which clicks open and closed with a simple push.
- > The lid has a ceramic feel and both the cup and lid area are made from a non-absorbent material eliminating stains and odours.
- > A handy window showing how much is left in your cup
- > The cup and lid click apart for easy and thorough cleaning.
- > Dishwasher and microwave safe.
- > Allows a natural drinking action- the lid allows the liquid to flow as it would from a cup and has a wider opening for other contents such a soup.
- > Non-slip base and low centre of gravity for stability.

**300-03680**  
MEDIUM CAFFE CUP BLACK WITH NONSLIP BASE 300ML

**300-03682**  
MEDIUM CAFFE CUP VIVID BLUE WITH NONSLIP BASE 300ML

**300-03684**  
MEDIUM CAFFE CUP ORANGE WITH NONSLIP BASE 300ML

**300-03686**  
MEDIUM CAFFE CUP PURPLE WITH NONSLIP BASE 300ML



## PALM TRITAN ALFRESCO DRINKWARE

Guaranteed unbreakable—made from super-tough BPA-free Tritan—this range of drinkware has the clarity of glass and dishwasher safe for 10 years.

**300-03688**  
WHISKY CUP CLEAR 450ML

**300-03690**  
HIGHBALL CUP CLEAR 550ML

**300-03692**  
WINE GLASS CLEAR 350ML

**300-03694**  
FLUTE GLASS CLEAR 200ML



## PALM TRITAN HIKING DRINKWARE

The Tritan Hiking range from Palm is designed for easy storage and transport. Guaranteed unbreakable and dishwasher safe for 10 years (private use). This range is the perfect choice to take on bushwalks and on the road.

**300-03696**  
WHISKY CUP 285ML

**300-03698**  
HIGHBALL CUP 425ML

**300-03700**  
WINE GLASS 260ML

**300-03702**  
FLUTE GLASS 190ML



## TOWING ACCESSORIES

## PALM TRITAN FRIDGE JUG

The Palm Tritan Fridge Jug has many great features making it perfect for your RV, caravan and camping.

- > Drip-free spout the innovative v-shaped spout makes pouring a breeze as well as keeping ice cubes from falling into your glass.
- > The ergonomic handle is easy to hold with its large vertical grip section
- > The lid slides on easily yet locks when tipped.
- > Designed to fit standard fridge doors, the jug is not too high or wide.
- > Innovative design and production means there are no unsightly seam lines.

**300-03704****FRIDGE JUG WITH CLEAR LID 1.3L****300-03706****FRIDGE JUG WITH WHITE LID 1.3L****300-03708****FRIDGE JUG WITH BLACK LID 1.3L****300-03710****FRIDGE JUG WITH BLUE LID 1.3L**

## PALM TRITAN SALAD BOWL

The Palm Tritan Salad Bowl with lid is a truly versatile item for your pantry. Unbreakable and dishwasher safe, this virtually airtight bowl can be used in many different ways, saving you precious storage space in your caravan or RV.

- > Salad bowl with lid keeps freshness in.
- > The lid on its own can be used as a serving tray.
- > The bowl can be used for all of your favorites such as chips, salad or fruit.
- > Flip the bowl over and it can be used with the lid as a base creating a covered cake tray.
- > Once inverted the bowl can be used to cover serving plates for freshness and hygiene.

**300-03712****SALAD BOWL WITH CLEAR LID 26.5CM****300-03714****SALAD BOWL WITH WHITE LID 26.5CM****300-03716****SALAD BOWL WITH BLACK LID 26.5CM****300-03718****SALAD BOWL WITH BLUE LID 26.5CM**

## TOW BALLS &amp; ACCESSORIES

**350-00018****ARK TOW BALL MOUNT & TOW BALL**

The adjustable Ark Tow Ball Mount is designed to level your trailer and vehicle. It has five adjustable points and is suitable for 4x4s.

**Max Towing Capacity: 2500kg\***

\* The towing capacity of the Ark Tow Ball Mount may exceed the towing capacity of the tow bar or vehicle. Always refer to the manufacturers specifications regarding the towing capacity of your tow bar or vehicle.

**350-00021****ARK BLACK SHIN PROTECTOR WITH TOW BALL COVER**

Ensures that the tow ball cover is secured whilst towing, suitable for 50mm and 1 7/8" tow balls.

**350-00022****3.5 TON, 50MM CHROME PLATED TOW BALL****Shank Size: 22.23mm****Diameter x 51mm, Towing Capacity 3500kg****350-00024****3.5 TON, 50MM CHROME PLATED TOW BALL****Shank Size: 22.23mm****Diameter x 62mm, Towing Capacity 3500kg****350-00026****2.5 TON, 50MM CHROME PLATED TOW BALL****Shank Size: 22.23mm****Diameter x 80mm, Towing Capacity 2500kg****350-00028****2.0 TON, 25.4MM HI RISE 50MM CHROME PLATED TOW BALL****Shank Size: 22.23mm****Diameter x 51mm, Towing Capacity 2000kg**



# TOWING ACCESSORIES

## REESE TOW VEHICLE ACCESSORIES

**350-00040**

### RATCHETING CARGO BAR

Strong and easy to use, the Reese® Ratcheting Cargo Bar will keep your cargo secured in the ute tub, tray or boot. Fitted with rubber end pads it will also protect the vehicle from scratches and metal contact.

The Ratcheting Cargo Bar extends from 102cm to 178cm, fitting most tub and cab chassis utes even fitting SUV or family wagon boots to keep the shopping and luggage where you need it most.

- > Helps prevent cargo from moving during travel
- > Universal fit extends from 102cm to 178cm
- > Padded ratcheting handle making comfortable tightening a breeze
- > Easy ratchet function to tighten means that installation is quick and easy
- > Rubber ends ensure that the vehicle is protected from scratches and cargo slippage



**350-00042**

### SMALL TAILGATE PROTECTIVE PAD

- > Simple installation and removal
- > Secures to tailgate with two attached straps with buckles
- > Top buckle strap secures cargo down to tailgate during transit
- > 600D weather resistant heavy duty fabric with a heavy duty foam core
- > Pad measurement 45cm x 22cm



**350-00044**

### LARGE TAILGATE PAD

- > Universal - fits most medium and larger size tailgates
- > Pad measurement 135cm x 70cm
- > Added cushioning and protection
- > Rainproof tarpaulin material
- > Three straps wrap around tailgate and secure with three buckles
- > Additional hook and loop straps secure cargo to the pad
- > Flap in centre of pad allows tailgate handle access
- > 600D weather resistant heavy duty fabric with a heavy duty foam core



**350-00046**

### TARP CLIPS 4 PC JAR

Need to anchor your tarp, awning or tent but don't have any usable eyelets?

Reese® Tarp Clips are the answer, made with high impact resistant plastic; the Tarp Clips provide hook anchor points to replace torn eyelets or to add additional anchor points where needed. They are ideal for securing canopies, tarps, awnings, tents, covers and much more.



The vice-like gripping power keeps your tarp in place to keep your gear safe and secure from the elements. Sold in a handy-to-store container, the Tarp Clips are ready when you are.

- > Made of high impact resistant material that will not damage tarps or canopies
- > Ideal for securing tarps, canopies, awnings, tents, covers and much more
- > Heavy Duty and crack resistant
- > Vice-like gripping power
- > Easy to tighten, easy to release
- > Comes in a handy reusable container for storage; you'll never have to hunt around for them in your toolbox or bag again

**350-00048**

### HITCH PIN LOCK & 3.6M CABLE

Prevent theft and lock your equipment, perfect for ute trays, trailers, caravans, roof and bike racks. Lock your cargo with ease



- > Installs in seconds with a push to lock feature
- > Stays on while towing
- > Braided steel for strength and flexibility
- > 3.6m vinyl coated 10mm cable
- > Corrosion resistant

**350-00050**

### CHROME CLIP-ON TOW BALL COVER

Protect your clothing from grease, clips on securely thanks to the spring clip inside, suits 50mm & 47.63mm (1 7/8") tow balls.



**350-00052**

### BLACK SOFT PVC TOW BALL COVER

Protect your clothing from grease, fits securely thanks to the moulded shape, suits 50mm & 47.63mm (1 7/8") tow balls.



**350-00054****BLACK CLIP-ON TOW BALL COVER**

Fits securely thanks to the spring inside, suits 50mm & 47.63mm (1 7/8") tow balls.

**350-00056****TOW BALL BUDDY COVER & SHIN PROTECTOR**

Enhance the look of your tow bar and keep your shins out of trouble with the ark tow ball buddy.

- > Clip on chrome cover
- > Covers ball and ball mount
- > Soft shin protector
- > Suits 50mm and 1 7/8" tow balls

**350-00060****HAYMAN REESE HITCH STEP**

Designed to stay in place whilst towing, the Hitch Step mounts over your tow ball. Three simple steps is all it takes to assemble your step onto the towbar's tow ball mount. The step features a high grade aluminium body with machine cut non-slip tread, making it corrosion resistant and giving extra grip for those slippery situations.



- > Easy to install, 4 bolts and you're done
- > Fits virtually any towbar, with a flat sided tow ball mount
- > Aluminium construction that is light-weight, corrosion resistant and looks great on the back of your car
- > High-grip non-slip step, keeping you safe in the wet
- > Raised upper lip to prevent you sliding off
- > Ideal for boat owners, helps keep your feet dry when launching or retrieving your boat

**Specifications**

**Weight Capacity:** 120kg  
**Length:** 355mm  
**Width:** 75mm

**350-00070****BLACK SHIN PROTECTOR**

No more bruised shins. Made from soft rubber the shin protector fits securely over the tow bar goose neck.

**SHACKLES**

The current standard applying to shackles is AS 2741-2002, however this standard does not specifically cover the use of rated shackles in an application such as attaching a trailer to a tow bar. This standard covers the use of shackles for lifting purposes.

The Caravan Industry Association of Australia's recommendation is that a shackle meeting the requirements of AS 2741-2002 be used to secure rated safety chains up to 3500kg capacity.

**Suitable shackles have the following specifications:**

- > Meet the requirements of AS 2741-2002
- > Shackle grade is "S" or "6"
- > Working load limit (WLL) is 1000kg
- > Shackle diameter is 10mm
- > Either "bow" or "dee" shackle design is suitable, although it is noted that the "bow" design provides greater angular displacement

A significant detail to understand is that the breaking load of a shackle is generally six times the working load limit." Source: RVMAP Technical Alert - D-Shackle Confusion Resolved, 20.10.2014

**450-05000****DEE SHACKLE GALVANISED 8MM (5/16")**

Not to be used with safety chains as this is a general purpose shackle.

**450-05002****DEE SHACKLE GALVANISED 8MM (5/16")**

Rated to 0.75t

**450-05010****DEE SHACKLE GALVANISED 10MM (3/8")**

With a working load rating of 320kg and a proof load rating of 640kg. Not to be used with safety chains as this is a general purpose shackle.

**450-05012****DEE SHACKLE GALVANISED 10MM (3/8")**

Rated to 1t



**450-05020**

**DEE SHACKLE GALVANISED 12MM**

A working load rating of 520Kg and a proof load rating of 1040Kg. Not to be used with safety chains as this is a general purpose shackle.



**450-05022**

**DEE SHACKLE GALVANISED 11MM (7/16")**

Rated to 1.5t



**450-05024**

**DEE SHACKLE GALVANISED 13MM (1/2")**

Rated to 2.0t



## HAND BRAKE SPARES

**450-05050**

**HAND BRAKE WIRE CABLE**

4mm x 10m length



**450-05060**

**HAND BRAKE CABLE ADJUSTER (With Pulley)**

(With Pulley)



**450-05070**

**HAND BRAKE CABLE CLIPS**



**450-05080**

**BRAKE CABLE PULLEY**



## ALKO COUPLINGS

**450-05110**

**2000KG 2-HOLE SNAP ON COUPLING WITH BALL ADJUSTER**

Zinc plated surface, ball to first centre.



**Specifications**

Mounting Hole: 101.6L x 13.5W (mm)

Hole: 77mm

**450-05120**

**3500KG ELECTRIC COUPLING WITH HAND BRAKE**

A zinc plated coupling that is simple to attach to the tow ball.

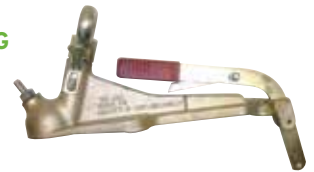

**Specifications**

Mounting Hole: 182.5L x 55W (mm)

Diameter: 13.5mm

**450-05130**

**2000KG MECHANICAL OVERRIDE COUPLING (NO PLATE)**

A zinc plated coupling that is suited to 50mm ball types.



**Specifications**

Mounting Hole: 184L x 54W x 13.5 Diameter (mm)

Diameter: 137mm

**450-05140**

**BRAKE PLATE FOR MECHANICAL OVERRIDE COUPLING**

Has a painted surface.



**Specifications**

Mounting Hole: 184L x 54W x 13.5 Diameter (mm)

**450-05146**

**ALKO AKS TOW BALL RETENTION PLATE**

AKS anti-rotation 50mm tow ball plate for lug type tow bar 75mm wide.



## TOWING MIRRORS

**450-05147****ALKO AKS HIGH RISE 50MM  
TOW BALL**

AKS anti-rotation 50mm high rise tow ball (black).

**450-05150****HYDRAULIC CONVERSION WITH  
3/4" MASTER CYLINDER**

Converts mechanical couplings to hydraulic couplings (a more reliable braking system), suited for vehicles with a hydraulic drum/brake set up, zinc plated.



## TOWING MIRRORS

**350-00330****TOWING MIRROR REPLACEMENT  
PLASTIC  
BUCKLE**

## MILENCO TOWING MIRRORS

**350-00402****MILENCO FALCON MIRRORS**

Lightweight and strap free, these Falcon mirrors feature an aerodynamic head to limit vibration whilst towing. They're super easy to attach to your vehicle's existing side mirrors, simply position the rubber grips onto your side mirror and tighten the thumb wheels accordingly. The convex mirror head is adjustable to maximise your tow vision. The Falcon comes with a handy storage bag and is suitable for use on most 4WD's and vans e.g. Nissan Navara. Sold in pairs.

**Specifications**

Mirror Head: 220W x 140H (mm)

Arm: 420mm

**350-00403****MILENCO GRAND FALCON  
CONVEX TOWING MIRROR  
(TWIN PACK)**

The Grand Falcon Mirror offers a new design utilising a similar operation as the Milenco Grand Aero Mirror, but with using only a single thumb screw on each clamp for quick and easy fitting with a larger head, giving maximum field of view. Typically the larger field of view will show the roof, down to the wheels on the towed caravan/trailer.



Fitting is extremely simple with a single screw that clamps both the car mirror and the arm at the same time.

**350-00405****MILENCO AERO 3 XXL  
WIDE CONVEX MIRROR  
(TWIN PACK)**

The Aero Extra Wide Mirrors and Grand Aero Extra Wide Mirrors are the same as the Aero 3 Mirrors and the Grand Aero 3 Mirrors. This mirror has longer arms for wider caravans, RV's or travel trailers, the Extra Wide Mirrors are only available in convex.



This enables users to have a better field of vision, particularly in instances when they have a narrow car and a wide caravan.

# TOWING MIRRORS

**350-00407**

**MILENCO GRAND AERO  
3 EXTRA WIDE CONVEX  
TOWING MIRROR (TWIN  
PACK)**

The Aero Extra Wide Mirrors and Grand Aero Extra Wide Mirrors are the same as the Aero 3 Mirrors and the Grand Aero 3 Mirrors. These mirrors have longer arms for wider caravans, RV's or travel trailers, the Extra Wide Mirrors are only available in convex.



The arm is approximately 41cm, as opposed to the Aero standard arm of 31cm.

This enables you to have a better field of view particularly when you have a narrow car and a wide caravan.

**350-00408**

**MILENCO FALCON SUPER  
STEADY TOWING MIRROR  
(TWIN PACK)**

The Falcon Super Steady Mirrors are quite simply the best budget mirrors money can buy.



These Mirrors are in a completely different league of engineering quality and design to other budget Mirrors. These Mirrors are superior in every way and fit easily to all vehicles. They are completely compliant with the very latest vehicle safety regulations and are approved to the new 04 series of approvals.

**350-00413**

**MILENCO MGI SAFETY  
TOWING MIRROR CONVEX  
SINGLES**

This mirror is ideal for those who tow occasionally. The MGI - Milenco Safety Mirrors are simple to fit, but more importantly, they meet all the latest Safety Regulations for Towing Mirrors. The tensioning straps and handles means they can be adjusted to fit most typical traditional car mirrors. Sold in singles



## MILENCO TOWING MIRRORS SPARES

**350-00411**

**MILENCO  
REPLACEMENT AERO  
PADS (2 PER PACK)**



**350-00412**

**MILENCO AERO  
MIRROR HEADS  
CONVEX**



**350-00414**

**MILENCO AERO  
EXTRA WIDE ARMS  
PAIRS**

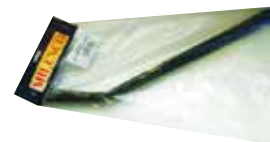

**350-00415**

**MILENCO AERO  
GRAND MIRROR  
HEADS FLAT**



**350-00416**

**MILENCO AERO  
GRAND MIRROR  
HEADS CONVEX**



**350-00419**

**MILENCO AERO  
CLAMPS**



## REICH TOWING MIRRORS



Reich made quite a name for themselves when they developed the Move Control Series of caravan movers. Now these innovative Germans have produced a range of towing mirrors designed to give you a vibration free, hassle free & obstruction free towing experience. They feature a turn knob which controls the length of the straps, ensuring maximum tightening security onto the existing car mirror.

**350-00600**  
**REICH EXCELLENT**  
**VIEW TOWING MIRROR**

The pioneer in the Reich Mirror Series, adjustable clip on mirror suitable for vans, 4x4's, motor homes etc, rigid construction minimizing vibration, has rubber suckers to protect your cars mirror, has a large 20 x 13(cm) convex mirror. Sold singularly.



**350-00620**  
**REICH HANDY MIRROR**  
**XL EXTENDED**

Same features as the XL mirror above but has longer arms making it suitable to tow wider & longer caravans. Sold singularly.



**350-00610**  
**REICH HANDY MIRROR**  
**XL**

Features positive adjustable straps with quick release, has an adjustable mirror head, the jointed arms allow for installation on large size vehicle mirrors, has a large 20 x 13cm convex mirror. Sold singularly.



**350-00640**  
**REICH SPEEDFIX MIRROR**

The name says it all! The Speedfix is a clip-on mirror with a patented rod end. The innovative fastening system, in conjunction with a semi-flex arm, ensures suitability with most 4WD and car mirrors. The rigid design and aerodynamic head ensures a vibration-free towing experience. Comes with a carry bag and is sold in pairs.



**Specifications**

Mirror Head: 220W x 120H (mm)  
 Arm: 350mm

## BRAKE CONTROLLERS

**350-01218****HAYMAN REESE COMPACT IQ PROPORTIONAL BRAKE CONTROLLER**

The Compact IQ is the 'proportional' version of the 'time-activated' Compact brake controller (part number 350-01216 above). The Compact IQ encompasses minimalism, thanks to its super easy plug and play installation. Two dials are left on the dashboard facilitating easy operation, while the actual controller is installed behind or under the dashboard. Suitable for use with 1-3 axles, it includes a 'boost' function to give the driver the ability to set a minimum braking power. An LED indicator (one of the dials on the dashboard) constantly shows the status of the braking system. The Compact IQ is fully compatible with Electronic Stability Control systems and comes with a Hayman Reese 3yr warranty.

**350-01238****TEKONSHA PRODIGY P2 12V BRAKE CONTROL**

Suitable for 1 - 4 axle trailers, the Prodigy P2 is a proportional style brake controller. It is designed to work in with electronic-over-hydraulic brake systems and has numerous mounting options, incorporating 360 degree vertical rotation. The Prodigy P2 adjusts itself to the terrain as you drive, making it especially handy when reversing into tough spots. It works proportionally in reverse, with the ability to disable itself when it is not needed. The "boost" feature gives users the ability to apply more braking power when towing heavier trailers/ horse floats, which also gives you more control. When not being used, the Prodigy P2 can be easily disconnected allowing for storage elsewhere.

**Specifications**

Weight: 590g

Dimensions: 76H x 114W x 267L (mm)

**350-01232****TEKONSHA #9030 VOYAGER 12V BRAKE CONTROL**

The Voyager has recessed controls which protect the gain and level settings from accidental readjustment. Its internal sensor measures the amount of deceleration and sends the required amount of power to the trailer brakes. Its circuitry ensures minimum interference with other electronic systems such as ABS & cruise control. The Voyager has the traditional 4-wire hook up and comes with a U-shaped bracket for permanent installation. The LED display shows a complete circuit when green and as power (whether manual or automatic) is applied, it will change colour. Suitable for single and double axle trailers.

**350-01250****TEKONSHA BREAKAWAY SWITCH (2010)**

For trailers over 2000kg (Gross Trailer Mass) it is a requirement that a mechanism is in place in the event that if the trailer and tow vehicle separate accidentally, the trailer brakes are applied at full power for at least 15 minutes. One way to combat this is with a breakaway switch which sets the trailer brakes in case the trailer breaks away, however this is not to be used as a parking brake. Made from nylon with a weldable tab.

**350-01260****TEKONSHA SHUR-SET III BREAKAWAY KIT**

Kit includes a 5A battery with lockable case and nylon breakaway switch and only weighs 2.5kg.

**Specifications**

Dimensions: 15.9L x 16.2W x 21.6H (cm)

## BRAKE CONTROLLERS

**350-01274  
BREAKSAFE REMOTE  
BATTERY MONITOR**

To be used in conjunction with the Breaksafe 6000 (part #350-01280 below), this remote monitor is fitted to the tow vehicle and checks the charge condition of the Breaksafe battery each time the brakes are applied. If the battery is low, a red light will be visible on the front panel of the monitor and a buzzer will sound.

**Specifications**

Dimensions (mm): 63W x 22H x 49L

**350-01276  
BREAKSAFE BATTERY**

A maintenance free and rechargeable sealed lead acid (SLA) battery. 12V, 7AH.

**350-01280  
BREAKSAFE BREAKAWAY  
SYSTEM 6000**

The Breaksafe 6000 is suitable for use in caravans, trailers & horse floats. It is compact & easy to install &, has easy access to the battery compartment for servicing. Its lead acid battery as well as the internal circuit board case is enclosed offering better resistance to water. Suits all electric brakes & is charged using your vehicle's battery.



## BREAKSAFE ACCESSORIES

**350-01283  
BREAKAWAY SWITCH WITH  
COIL CABLE**

The Breaksafe Breakaway Switch now comes with a new coil cable and stainless steel quick release clip for easy connection to your towing vehicle. This also makes the connection to the tow vehicle much neater. The coil cable stretches to 1.2mts for connection to the tow vehicle and will compress to 100mm when disconnected.

**350-01285  
BREAKAWAY COIL CABLE  
WITH PIN AND RELEASE CLIP**

Suitable for Breaksafe Breakaway switches only, this option is available if you already have a Breaksafe Breakaway Switch.



## TEKONSHA PRODIGY SPARE PARTS

**350-01300  
TEKONSHA PRODIGY MOUNTING BRACKET****350-01310  
TEKONSHA PRODIGY POCKET MOUNT KIT****350-01320  
TEKONSHA PRODIGY HARNESS KIT**



## BRAKE CONTROLLERS

## TOW SECURE BREAKAWAY KITS

**350-01406**  
**TOW SECURE TS2000**  
**BREAKAWAY CONTROL +**  
**HARNESS WITH TEKONSHA**  
**SWITCH**



The Tow Secure TS2000 automatically applies the trailer brakes and the trailer stop lights in the event that the trailer separates from the tow vehicle. The TS2000 uses the battery in your RV as its source of energy storage meaning that without an internal battery it is nice and compact. It features a 5m wiring harness to connect to the RV's battery which it will not draw power from while on standby

It has a wireless receiver which is housed on the dash so that the driver can monitor the battery status via LED and audible alarms. The control module performs a 'self-test' every time the tow vehicles' engine is started to ensure everything is operable and whilst towing. The control module can be paired with multiple wireless receivers - this may be required if the same trailer is towed by different vehicles.

- > Reduced size thanks to no internal battery
- > No power draw while on standby
- > 5m Wiring Harness
- > Power indicating LED

**350-01500**  
**TOW SECURE CHARGER**

Input: 100/240VAC ~ 50/60Hz  
 Output: 15VDC ~ 1A Max.



**350-01502**  
**TOW SECURE RECEIVER ONLY**



## CURT BRAKE CONTROLLER'S

**350-01340**  
**CURT TRIFLEX™ BRAKE**  
**CONTROLLER**

The TriFlex™ proportion-based brake controller features a compact size, a digital display and the ability to manage up to eight brakes at a time.



- > Triple-axis, motion-sensing accelerometer for highly responsive, smooth stops
- > Third axis provides dynamic power adjustments when going up or down a hill
- > Nine levels of sensitivity adjustment for varying loads or driving conditions
- > User-selectable power output and trailer brake light activation
- > Automatic levelling and calibration eliminate setup requirements
- > The digital display shows power adjustments in 0.1 increments
- > Built-in reverse-polarity and short-circuit protection
- > Tow vehicle 'low voltage' and trailer disconnect indicators
- > Compatible with low-volt, PWM, ABS, cruise control and electric over hydraulic
- > Mounts at various angles, above or below the dash, to increase usability
- > Auto sleep mode prevents battery drain after five minutes of idle time
- > Equipped with a quick plug for fast, easy installation
- > Includes mounting hardware

**350-01342**  
**CURT SPECTRUM BRAKE**  
**CONTROLLER - DASH MOUNT**

Powerful, precise braking operation in an extremely simple and subtle design, dash-mounted inside your vehicle.



- > Controls all brake settings with a simple push-button rotary knob
- > Clean, dash-mounted, OEM-style user interface with 10 tri-colour LEDs
- > The main module can be mounted out of sight
- > Motion-sensing accelerometer for highly responsive, smooth stops
- > Easily accessible manual override with the press of a button
- > Features two installation options: drill mount or surface adhesive mount
- > User-selectable power output and trailer brake light activation
- > Automatic levelling and calibration eliminate setup requirements
- > Equipped with a quick plug for easy, plug-and-play installation
- > Operates 2-8 trailer brakes at a time (1-4 axles)
- > Built-in reverse-polarity and short-circuit protection
- > Compatible with low-volt, PWM, ABS, cruise control and electric over hydraulic
- > Tow vehicle 'low voltage' and trailer disconnect indicators
- > Includes mounting hardware
- > Knob outside diameter is 48mm

**350-05232****SECURELATCH™ PINTLE HOOK**

The CURT SecureLatch pintle hook is fast and easy to adjust, featuring an auto-locking system and rated to 13,500kg. For use with the Rebellion™ XD Pintle Mount Attachment.



- > Auto-locking system secures primary latch without manual coupling required
- > Cupped hook tightly holds pintle ring fore and aft to reduce chucking and noise
- > Built-in backplate helps position pintle ring for easier hookup
- > Fits SecureLatch pintle mounts with a slotted plate (sold separately)
- > Quick, easy, one-tool height adjustments - no disassembly required
- > Integrated, intermediate safety chain hangers keep chains off the ground
- > Rated for 13,500kg gross trailer weight and 2720kg vertical load
- > Couples to pintle rings with a 2-1/2" or 3" inside diameter
- > Cast iron construction is austempered for superior strength and wear resistance
- > Battleship grey finish for excellent exterior durability
- > Bright zinc-plated hardware for corrosion resistance (mount bolts not included)
- > Limited lifetime warranty (one-year finish, one-year parts)
- > SecureLatch pintle mount and bolts required for installation (sold separately)
- > Safety pin must be installed before towing

**350-50000****CURT REBELLION™ XD BALL MOUNT**

Dynamic, adaptive suspension ball mount featuring ShockDrop™ technology.



- > Dynamic, adaptive suspension ball mount featuring ShockDrop technology
- > Dampens jerking and jarring from bumps and potholes for smoother towing
- > Cushioned isolator reduces rattling and vibration for a more comfortable ride
- > Increases driver control by reducing the tendency for trailer sway
- > Improved trailer control during events of sudden braking
- > Virtually maintenance-free with no airbag or bearings to service
- > Minimises stress on tow vehicle's suspension and brakes for extended longevity
- > Lighter-weight design for less stress on the trailer hitch receiver
- > Adjustable, six-position head for precise levelling with different trailers
- > 152mm maximum drop (shank cannot be flipped)
- > Cast steel construction for dependable towing power
- > Textured, dark grey teridium finish for a premium look on your vehicle
- > Tested and rated to 4500kg/450kg
- > Fits 50mm Square Hitch (Class 4)

**350-50002****REBELLION™ XD TONGUE ATTACHMENT (50MM TOW BALL)**

7/8" hole to accept a 50mm tow ball. Mounts onto CURT Rebellion™ XD Adjustable Ball Mount.



- > Mounts onto CURT Rebellion XD Adjustable Ball Mount
- > 7/8" hole to accept a 50mm tow ball
- > Constructed from cast steel for optimum strength
- > Protected by a dark grey teridium powder coat finish
- > Weight capacity: 3500kg/350kg

**350-50004****REBELLION™ XD TONGUE ATTACHMENT (70MM TOW BALL)**

1-1/4" hole to accept a 70mm tow ball. Mounts onto CURT Rebellion™ XD Adjustable Ball Mount.



- > Mounts onto CURT Rebellion XD Adjustable Shank
- > 1-1/4" hole to accept a 70mm tow ball
- > Constructed from cast steel for optimum strength
- > Protected by a dark grey teridium powder coat finish
- > Weight capacity: 4500kg/450kg

**350-50006****REBELLION™ XD PINTLE MOUNT ATTACHMENT**

Accepts any CURT mount-style pintle hook or ball and pintle combination hitch. Mounts onto CURT Rebellion™ XD Adjustable Ball Mount.



- > Mounts onto CURT Rebellion XD Adjustable Shank
- > Accepts any CURT mount-style pintle hook or ball and pintle combination hitch
- > Integrated rubber dampener for enhanced vibration resistance
- > Constructed from cast steel for optimum strength
- > Protected by a dark grey teridium powder coat finish
- > Standard pintle plate holes spaced 84mm wide by 31mm high
- > Weight capacity limited to Rebellion XD ball mount
- > Includes four bolts to mount the pintle hitch (Rebellion XD sold separately)

**350-50010****REBELLION™ XD TONGUE & HITCH LOCK SET**

This lock set for the Rebellion™ XD ball mount provides enhanced security for your towing setup. The unique, integrated design fits all CURT Rebellion XD accessories.



- > Lock set secures both Rebellion XD tongue and shank
- > Locks replace standard clips and hitch pin for increased security
- > The unique, integrated design fits all CURT Rebellion XD accessories
- > Easy-to-operate, 1/4-turn lock activation
- > Locks keyed alike for convenient one-key operation
- > Cast aluminium accessory lock for superior weather resistance
- > Stainless steel hitch lock for lasting rust resistance
- > Includes two locks and two keys

**350-51000****CURT 5/8" TOW HITCH PIN WITH CLIP SET**

- > 15.8mm diameter pin fits 50 Square Hitch (Class 4)
- > Secures ball mounts and other receiver tube inserts
- > Bent handle for an easier grip



## 350-51002

### CURT 5/8" GROOVED TOW HITCH PIN WITH CLIP SET

- > 15.8mm diameter pin fits 50mm Square Hitch (Class 4)
- > Secures ball mounts and other receiver tube inserts
- > Grooved pin allows clip attachment at any angle
- > Protected by a durable zinc-plated finish



## 350-51010

### CURT 5/8 IN RIGHT ANGLE LOCKING TOW HITCH PIN

- > 15.8mm diameter pin fits 50mm Square Hitch (Class 4)
- > Right-angle design with swivel head for easier access
- > Protected by a durable chrome-plated finish
- > Easy-to-operate, 1/4-turn lock activation
- > Watertight dust cap prevents internal corrosion
- > Includes two keys for added convenience



## 350-51012

### CURT 5/8 IN DOGBONE LOCKING SS TOW HITCH PIN

- > 5.8mm diameter pin fits 50mm Square Hitch (Class 4)
- > Stainless steel construction for lasting rust resistance
- > Easy-to-operate, 1/4-turn lock activation
- > Watertight dust cap prevents internal corrosion
- > Includes two keys for added convenience



## 350-51014

### CURT 5/8 IN DOGBONE CHROME LOCKING TOW HITCH PIN

- > 15.8mm diameter pin fits 50mm Square Hitch (Class 4)
- > Protected by a durable chrome-plated finish
- > Easy-to-operate, 1/4-turn lock activation
- > Watertight dust cap prevents internal corrosion
- > Includes two keys for added convenience



## 350-52000

### CURT TRUTRACK™ WEIGHT DISTRIBUTION HITCH WITH SWAY CONTROL

TruTrack™ weight distribution hitches with sway control are one of the most advanced weight distribution hitches on the market.

- > Integrated sway control actively resists sway and levels the vehicle and trailer
- > Welded head with cast pieces provides solid spring bar attachment
- > Uses spring & cam system with hardened components, instead of metal friction
- > Adjustable brackets provide fixed support unlike spring bar chain models
- > Brackets use friction to resist lateral movement, replacing a sway control



## 350-53000

### ROCKERBALL™ 50MM CUSHION HITCH TRAILER BALL

As your trailer passes over bumps and potholes, it produces all kinds of vibrations, jolting, chucking and noise. With a traditional metal-on-metal connection, these annoyances are directly transferred to your tow vehicle, making your ride noisy, uncomfortable and taking a toll on your towing system.



The CURT RockerBall™ trailer ball provides improved comfort and enhanced control while towing, featuring our unique ShockDrop™ technology. An integrated cushion isolator allows this hitch ball to turn a standard ball mount into a cushion hitch with anti-rattle capabilities.

- > Dynamic trailer ball featuring ShockDrop technology
- > Dampens jerking and jarring from bumps and potholes for smoother towing
- > Cushioned isolators reduce rattling and vibration for a more comfortable ride
- > Reduces shock loads to the vehicle during sudden braking or acceleration
- > Minimizes stress on tow vehicle's suspension and brakes for extended longevity
- > Retrofits onto most existing ball mounts to improve current towing experience

## 350-52500

### CURT SWAY CONTROL KIT

CURT Sway Control Kit is adjustable and easy to install. It comes with a sway unit, a trailer-mounted attachment ball, and bolts, a hitch-mounted attachment ball, a weld-on tab, a mount reinforcement plate, and attachment clips.



Though a weight-distribution hitch is not an ideal solution for trailer sway on its own, CURT weight distribution hitches are made to be combined with a sway control unit and many are available with sway controls included for a complete package.

- > Features adjustment bolt to accommodate different load sizes
- > On/Off handle makes it easy to engage or disengage sway control as needed
- > Two sway control units are recommended for larger trailers
- > Compatible with most A-frame trailers (bolt-on bracket included)
- > Includes sway control unit, trailer-mounted attachment ball & bolt, hitch-mounted attachment ball, weld-on tab to adapt for left-hand use or for use without weight distribution hitch, mount reinforcement plate and attachment clips.

## CURT CARGO BAGS

**350-00030****CURT TRAILER BALLS**

CURT Trailer Balls are designed for strength, ease of use, and ultimately, to get you to your destination without hassle.

These tow balls are an excellent extension of your class 3 or class 4 trailer hitch and ball mount, and are the ideal choice for most pickup trucks and SUVs (NOTE: Never exceed the lowest weight capacity of any towing component; i.e. the vehicle, hitch, trailer, etc).



To give you peace of mind while towing to that next destination, we also carefully test our trailer balls and ensure that each one meets U.S. VESC specifications.

- > Fine threads for superior hold
- > Chrome-plated finish
- > Zinc-plated hardware
- > VESC tested for safety

**450-00500****CURT WHEEL CHOCK SET (UP TO 17" WIDE WHEELS)**

- > Ideal for chocking wheels on a parked trailer
- > Perfect for adding safety during vehicle maintenance
- > Compatible with wheels up to 17" wide
- > Raised tread offers a better grip on the wheel
- > Saw-tooth edges on the base provide solid traction on the ground
- > Constructed from durable plastic
- > Always to be used with vehicle brake
- > Not for commercial use

**CURT CARGO BAGS**

CURT cargo bags are the ideal way to keep your belongings well protected from water, dirt, road grime and even wind damage, all while being easy to manage and perfectly fitted for a CURT cargo carrier or roof basket. Unlike other cargo bags that use a thin vinyl material, our cargo bags are made from a thick UV-resistant vinyl and have welded seams to be highly water-resistant. Thick, 1" wide polypropylene straps keep the bag firmly attached to the carrier and ensure your belongings will not jostle around.

**400-04400****CURT CARGO BAG WEATHER-RESISTANT VINYL**

1422 x 457 x 533mm

**400-04402****CURT CARGO BAG WEATHER-RESISTANT VINYL**

1422 x 558 x 533mm

**400-04404****CURT CARGO BAG WEATHER-RESISTANT VINYL**

965 x 863 x 457mm

**400-04406****CURT CARGO BAG WEATHER-RESISTANT VINYL**

1498 x 863 x 533mm



## SPHERE TYRE PRESSURE MONITORING SYSTEM AND EXTERNAL SENSORS



Sphere's new Tyre Pressure Monitoring Systems features a solar-powered LCD display wirelessly connected to four waterproof external sensors to monitor individual tyre pressure in real-time. It is the first system in Australia which can be upgraded to monitor up to 10 sensors (including 2 spare tyres) without a booster.

### 350-01602 SPHERE SOLAR POWERED TPMS KIT WITH 4 EXTERNAL SENSORS

The Tyre Pressure Monitoring System has visual and audible alerts when there is tyre air leakage, high tyre temperature, and too low or too high tyre pressures. The monitor also allows users to customize the high/low pressure alarm threshold by each axle. Users can set the low-pressure alarm as low as 7Psi for especially rough terrains, or change the alarm threshold for an axle taking a heavier load. When fully charged, the solar-powered LCD display battery lasts for 60 hours.

- > BAR/PSI unit setting
- > °F/°C unit setting
- > Rechargeable solar-powered display with high temperature resistant battery
- > Automatic backlight night view
- > Automatic screen brightness for clear view under strong sunlight
- > Auto-sleep function for power-saving
- > Vibration-activated auto-wake function
- > Extra USB charging port
- > One full charge lasts for 60 hours



### 350-01610 SPHERE - TPMS PACK OF 2 EXTERNAL SENSORS

The IP67 waterproof external sensors can withstand harsh environments and monitor real-time pressures with an impressive  $\pm 1.5$ Psi accuracy. Each external sensor is also powered by a replaceable CR1632 button battery and is made with anti-theft lock nuts to provide extra security, requiring our patented tool to remove it.



- > DIY installation
- >  $\pm 1.5$ Psi High accuracy
- > 9g external sensors, no need for wheel rebalancing
- > IP67 protection against dust and water
- > Replaceable sensor battery - CR1632 button cell.
- > 2-year sensor battery life
- > Anti-theft lock nuts included to provide extra security

## LIPPERT TIRE LINC

## LIPPERT TIRE LINC

**ALWAYS BE READY FOR THE ROAD.**

Is your RV ready for the road? The Tire Linc® (TPMS) by Lippert™ is the easy-to-install, always-on tyre pressure and temperature monitoring system that makes sure you're always ready for the road. Integrated with Lippert's OneControl® app, you can monitor your camper trailer, caravan, motorhome, or towed vehicle's tyre pressure and temperature right from your smartphone – don't mess with additional dashboard interfaces again.

**350-01624****LCI LIPPERT TIRE LINC 2.0 AU BLUETOOTH TPMS KIT**

Tire Linc® comes complete with four sensors that easily screw on to your existing tyre valves. Additional sets of two extra sensors are sold separately. Installation is a breeze. Starting in 2021, certain RV models will be prepped for the Tire Linc system. For these models, simply place the repeater in the preinstalled docking station and you're ready to go. For those campers not prepped for Tire Linc, the repeater dock (sold separately) will need to be wired into the RV's 12V power system. The Tire Linc® repeater boosts your tyre's sensor signals to ensure that wherever you are, your system is communicating tyre pressure and temperature effectively.



Before a trip, on the road, and in any weather conditions, make sure you know the state of your tyres, with the monitoring system from a manufacturer you trust.

**Specifications**

- > **CONSTANT PRESSURE/TEMPERATURE MONITORING** – Sensors update pressure and temperature several times each minute while your RV is moving and check every 15 minutes while parked. Plus, sensors notify you any time the tires inflate, deflate, or in the case of a blowout
- > **REPEATER TECH BOOSTS SIGNAL** – Repeater technology "repeats" the signal your sensors send, but stronger, so that your smartphone always has the most up-to-date information.
- > **INTEGRATION WITH ONECONTROL APP** – Manage your sensors, set tyre pressure ranges, get notifications, and view alerts all from your smartphone with the OneControl® app from Lippert™
- > **MONITOR MORE TIRES** – Tire Linc® Tire Sensors allow you to monitor up to 20 tyres at a time with your Tire Linc system. Our additional sensor packs (sold separately) are a perfect way to monitor all tyres on larger RVs, motorhomes, and even tow vehicles
- > **SIMPLE INSTALLATION** – Sensors easily screw on to existing tyre valves, and the repeater plugs into a pre-installed dock (on specific 2021 and beyond models only). Use your OneControl® app to configure sensors and set acceptable tyre pressure ranges

## LIPPERT LCI SWAY COMMAND KIT



**Tow with confidence. Tow with peace of mind. If you tow a travel trailer RV you know all too well how scary a sway event can be, especially when making emergency maneuvers at high speeds or in heavy crosswinds.**

Lippert's new patent pending Sway Command Tow Control Technology is here to take away those fears and promote safety by applying the brakes before a sway event can get out of control!

The Sway Command utilizes both an accelerometer (measures lateral force) and gyroscope (measures angular velocity) to quickly and accurately differentiate between side-to-side and up-and-down movement to prevent false activation - very useful, especially off road!

It has an advanced, patent pending, microprocessor technology that electronically detects trailer sway to apply the brakes swiftly to suppress unswayed sway. A light pod mounts to the front of the trailer to signal to the driver when the system is functioning properly.

The Sway Command has been rigorously tested in sway-inducing towing conditions, including emergency maneuvers, so you can be confident in its abilities. Plus, the controller works independently from your existing brake control so if there is a short or disconnect in the tow vehicle connection, the Sway Command won't also be affected.

### **350-01700** **LCI SWAY** **COMMAND KIT**



### **350-01720** **ROAD GUARD** **PREFABRICATED CHASSIS** **BRACKET T/S SWAY** **COMMAND**



## QUICK FIT BIKE RACKS



Coast's new Quick Fit Bike Racks are designed to make it easier than ever to take bikes with you on your next adventure. They feature a patented quick connector that makes it extremely quick and easy to fit the racks onto your tow ball!

Unlike other bulky bike racks, the Quick Fit range is made with an ingenious folding system unique to the XF series. This allows you to collapse the Bike Racks to a convenient size that make them easy to carry and store. They even have a clever tilt mechanism that gives you clear access to your boot while the Quick Fit Racks are installed.

The Quick Fit XF series are designed to suit all 50mm tow balls thanks to the adjustable quick connector and can carry nearly all bikes (including e-bikes) and wheel dimensions on their wide aluminium wheel holders. The Quick Fit Pro offers incredible value for money and allows you to mount your bikes so there is no force on the pedals and uses wide plastic wheel holders. The full range features optional Assist Ramps that allows users to maneuver bikes onto the rack effortlessly.

You won't need to worry about putting them together either - they come ready to go straight out of the box and come with everything you need including a handy storage bag.

**350-20100****QUICK FIT XF3 FOLDING BIKE RACK - 60KG CAP**

The Quick Fit XF3 is a safe and reliable bike carrier for the transportation of 3 bicycles.

- > Suitable for almost all tow bars, all bicycles (also e-bikes) and wheel dimensions
- > An ingenious folding system makes it easy to carry and store
- > Extremely easy and quick fitting onto the tow bar with the patented quick connector
- > Boot is always accessible thanks to the easy to use tilt mechanism
- > The bicycles are held in wide, stable aluminium wheel holders
- > Flexible lockable and removable Quick Fit frame holders
- > Storage bag included
- > Lighting via a 7 plug
- > Immediate usable from the carton



- > The bike carrier can be secured with the lock on quick connector
- > In combination with the ride-on ramp (350-20120) you can even more easily manoeuvre your bicycle onto the bike carrier

**Specifications**

<b>Number of bicycles:</b>	3
<b>Tilttable:</b>	Yes
<b>Foldable:</b>	Yes
<b>Mounting of bicycles by:</b>	lockable and removable frame holders
<b>Weight:</b>	approx. 21 kg
<b>Maximum load:</b>	60 kg
<b>Bicycle frame diameter:</b>	Ø 22 - 75 mm*
<b>Wheel base bicycle max.:</b>	1250 mm
<b>Bicycle tyre width max.:</b>	55 mm
<b>Wheel holder distance:</b>	approx. 220mm
<b>Colour:</b>	Black
<b>Material:</b>	Coated steel + aluminium



# QUICK FIT BIKE RACKS

## 350-20102

### QUICK FIT XF2 FOLDING BIKE RACK - 60KG CAP

The Quick Fit XF2 is a safe and reliable bike carrier for the transportation of 2 bicycles.

- > Suitable for almost all tow bars, all bicycles (also e-bikes) and wheel dimensions
- > An ingenious folding system makes it easy to carry and store
- > Extremely easy and quick fitting onto the tow bar with the patented quick connector
- > Boot is always accessible thanks to the easy to use tilt mechanism
- > The bicycles are held in wide, stable aluminium wheel holders
- > Flexible lockable and removable Quick Fit frame holders
- > Storage bag included
- > Lighting via a 7 plug
- > Immediate usable from the carton.
- > The bike carrier can be secured with the lock on quick connector
- > In combination with the ride-on ramp (350-20120) you can even more easily manoeuvre your bicycle onto the bike carrier



#### Specifications

**Number of bicycles:** 2

**Tiltable:** Yes

**Foldable:** Yes

Mounting of bicycles by lockable and removable frame holders

**Weight:** approx. 17 kg

**Maximum load:** 60 kg

**Bicycle frame diameter:** Ø 22 - 75 mm\*

**Wheel base bicycle max.:** 1400 mm

**Bicycle tyre width max.:** 50 mm

**Wheel holder distance:** approx. 210mm

**Colour:** Black

**Material:** Coated steel + aluminium

## 350-20106

### QUICK FIT PRO BIKE RACK - 60KG CAP

The Quick Fit Pro is a safe and reliable bike carrier for the transportation of 2 bicycles.

- > Suitable for almost all tow bars, all bicycles (also e-bikes) and wheel dimensions
- > Extremely easy and quick fitting onto the tow bar with the patented quick connector
- > Boot stays always accessible by an easy to use tilt mechanism
- > The bicycles are held in wide, stable plastic wheel holders
- > Mounting the bicycles with the frame, so there is no force on the pedals of the bicycle
- > Flexible and lockable frame holders
- > Lighting via a 7 plug
- > The bike carrier can be locked with lock on quick connector
- > European permission given by the RDW



In combination with the ride-on ramp (350-20124) you can even more easily manoeuvre your bicycle onto the bike carrier

#### Specifications

**Number of bicycles:** 2

**Tiltable:** Yes

**Foldable:** No

Mounting of bicycles by lockable and removable frame holders

**Weight:** approx. 17 kg

**Maximum load:** 60 kg

**Bicycle frame diameter:** Ø 22 - 75 mm\*

**Wheel base bicycle max.:** 1300 mm

**Bicycle tyre width max.:** 50 mm

**Wheel holder distance:** approx. 200mm

**Colour:** Silver

**Material:** Coated steel

\* The maximum dimensions for any vehicle, including its load, are 2.5m in width and 4.3m in height. A vehicle fitted with a bicycle carrier, along with any bicycles must not exceed these limits.

Rear-mounted bicycle carriers must also comply with rear overhang limits. Any rear overhang on a vehicle must not exceed 60% of the wheelbase or 3.7m, whichever is less.

## QUICK FIT ASSIST RAMPS

A ramp makes effort unnecessary and bicycles can be easily manoeuvred onto the bike carrier. These ramps are suitable for Quick Fit bike carriers and are easy to fold up and store.



By placing a pin in the bike carrier's wheel holder, you can attach the ride-on ramp firmly and manoeuvre the bikes on and off easily.

## 350-20120

### QUICK FIT XF BIKE ASSIST RAMP

## 350-20124

### QUICK FIT PRO BIKE ASSIST RAMP

## CARRY BIKES

Flexible and sturdy with a renewed design, the best-selling Fiamma bike carriers boast a new shape and colour to blend perfectly with most modern RVs.

### 350-02008 FIAMMA CARRY BIKE XL A PRO 200 A FRAME MOUNT 2 BIKES

Equipped with the external rail in two pieces to grant maximum possibility of installation and use. Smaller size for short drawbars.



#### Specifications

Weight: 7.5kg  
Max Load Weight: 50kg

### 350-02022 FIAMMA CARRY BIKE CARAVAN XL A BLACK 2 BIKES

Compact and inexpensive, fits almost all Caravan frames (including Al-Ko).



#### Specifications

Weight: 5.3kg  
Max Load Weight: 35kg

### 350-02013 FIAMMA CARRY BIKE CARAVAN XL A PRO 200 E-BIKE

The installation does not require holes on standard.



#### A-frame

- > Installation brackets Supplied as standard. Bike carriers installation without drilling holes on standard A-frames.
- > Quick Lock Quick and safe locking of the wheel to the rail
- > Protective bumpers To protect the bike from impacts with the bike carrier structure
- > Bike-Block Pro / Pro S Bike locking system
- > Rails The model changes according to technical characteristics
- > Security block Locks the support rail during transport
- > Tensioning strap In the Active and Active E-Bike versions it makes access to the storage compartment easy and immediate

### 350-02017 FIAMMA CARRY BIKE VAN 200D

An easily installed bike carrier for vans with double rear doors (no need to drill the vehicle). The wheelbase is adaptable, from 58 - 62cm, to adapt to different sized doors. Carries up to two bicycles and is suited to vehicles such as: Fiat Ducato before 1999, Ford Transit and Ford Transit (high roof).

#### Specifications

Max Load Weight: 35kg

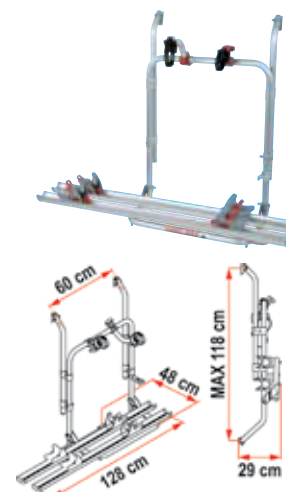

### 350-02020 FIAMMA CARRY BIKE BACKPACK 4X4

Best suited to minivans. The Backpack 4x4 is quickly installed onto the rear spare tyre by means of sturdy straps, however it will be necessary to remove the cover of the spare tyre. Has a folding rail support and can hold two bicycles. When installing, be sure not to cover the license plate or lights.



#### Specifications

Max Load Weight: 35kg

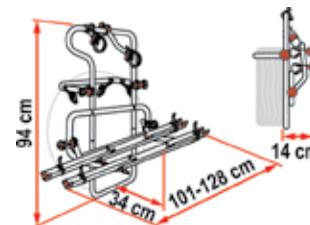

### 350-02041 FIAMMA CARRY BIKE PRO M, BLACK



## CARRY BIKES

**350-02042****FIAMMA CARRY BIKE PRO WITH BLACK AESTHETICS**

This telescopic bike carrier, the longer version of the pro series, has a highly adjustable upper structure for better stability and is height adjustable from 80cm to 150cm. Able to carry up to 4 bicycles.

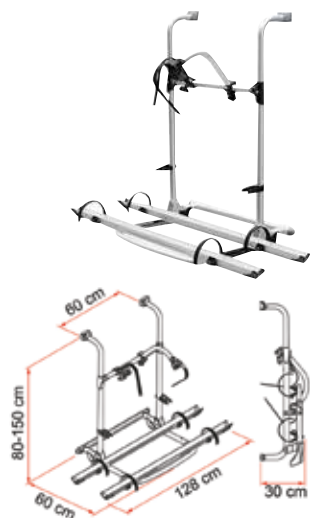
**350-02063****FIAMMA CARRY BIKE VWT5**

Another one of Fiamma's best sellers, the Carry Bike VWT5 is easily installed (no drilling required) on VWT5's built after July 2003. It is designed for T5's with a single rear door and has the capacity to fit up to four bicycles.

**Specifications**

Max Load Weight: 60kg

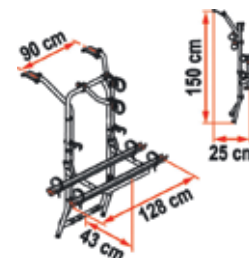
**350-02044****FIAMMA CARRY BIKE PRO C WITH BLACK AESTHETICS**

This compact and classic bike carrier is the short version of the pro series. It can be installed under the rear window while still allowing the window to open. The Pro C can be installed on most motorhomes and has been recommended as one of the strongest bike carriers on the market. Able to carry up to four bicycles.

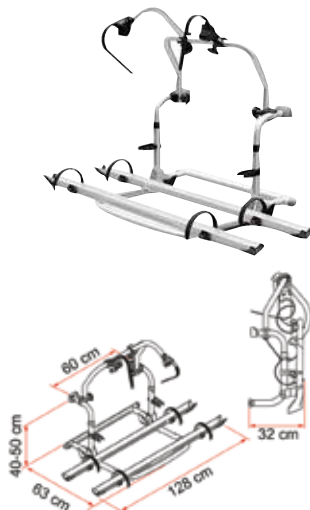
**350-02033****FIAMMA CARAVAN ACTIVE E-BIKE**

Special version specifically designed for the transportation of two electric bicycles. Thanks to the system with tensioning strap, access to the storage compartment is easy and quick.

**350-02087****FIAMMA CARRY BIKE 200 DJ SPRINTER**

Suitable for use on vans with double rear doors, in particular, Mercedes Sprinters built after June 2006 and Volkswagen Crafters built after June 2006. This Carry Bike is installed on one of the rear doors, allowing you to gain access to the rear of your van without having to remove your bikes. It has the ability to carry up to two bikes and comes with Bike Block Pro 1 and Pro 2. No drilling is required, except for the security screws. The Carry Bike 200 DJ Sprinter weighs 9kg.

**Specifications**

Max Load Weight: 35kg

**PRO SERIES E CARRY-BIKES**

Two structurally sturdy models, equipped with fixed rail support base designed specifically for electric bikes, featuring the Bike Block Pro S and Rail Premium.

**350-02047****FIAMMA CARRY BIKE PRO E-BIKE WITH BLACK AESTHETICS**

The telescopic bike carrier, leader of Pro line, here is the special version for E-Bikes. Has a highly adjustable upper structure for better stability. The rounded tube structure is easily adjustable from 80 to 150cm in height to fit different installation requirements.

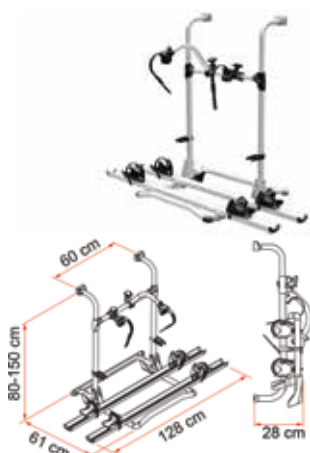

## CARRY BIKE ACCESSORIES

**350-02092****FIAMMA CARRY BIKE DJ DUCATO**

The new structure, thanks to the adoption of a single 35mm Ø aluminium tube, is light and modern, maintaining the solidity that has always distinguished this model.

The new structure guarantees a quicker and safer installation, also thanks to the new system of attachment of the main structure to the Fixing Bars.

This version allows the mounting of the rail support base in three positions, standard, intermediate and lowered to facilitate the loading of the bikes. In the intermediate and lowered positions it is necessary to use the licence plate holder bar with lighting group Licence Plate

**Specifications**

Weight: 11kg

Max Load Weight: 35kg

**350-02052****FIAMMA CARRY BIKE UL**

The UL is suitable for installation on motorhomes without a rear window. It is able to carry two bikes as standard, to carry a third bike (with a max load of 55Kg) an extra Bike-Block and Rail will need to be purchased. The mounting bars can be adjusted from 80-150cm, making the UL the preferred choice of many motorhome manufacturers.

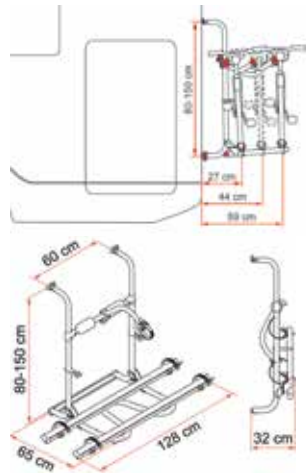
**Specifications**

Weights: 5.6kg

**FIAMMA CARRY BIKE ACCESSORIES****350-02210****E-BIKE REPLACEMENT RACK FOR PRO & PRO C**

Now you can turn your Carry-Bike Pro / Pro C into a E-Bike bike carrier by purchasing the new Kit Upgrade E-Bike.

Complete rail support base with two Rail Premium, structurally designed to carry two electric bicycles.

**Specifications**

Description	Pro E -Bike	Pro C E-Bike	XLA Pro 200
Part Number	350-02046	350-02048	350-02014
Vehicle Type	Motorhome & Caravan	Motorhome & Caravan	Caravan
Weight	10.4kg	9.9kg	10kg
Max load	60kg	60kg	50kg
Bikes Carried standard	2	2	2
Bikes carried max	2	2	2

**350-02252****FIAMMA CABLE LOCK FOR CARRY-BIKE (2.5M)**

Comes with 2 keys.

**350-02290****FIAMMA BIKE - RACK RAIL (128CM)**

With Quick Strap.

**350-02295****FIAMMA BIKE-RACK RAIL WITH BLACK END CAPS AND QUICK STRAP****350-02298****FIAMMA CARRY BIKE RAIL PREMIUM (128CM)**

**350-02215**

**FIAMMA RAIL PREMIUM XL (E-BIKE)**

The XL version is longer (139cm) and suited for particularly long E-Bikes and Mountain-Bikes (with wheelbase > 125cm).

**350-02320**

**FIAMMA BIKE BLOCK PRO - 1 RED FOR CARRY-BIKE (110MM)**

**Specifications**  
Weighs: 0.2kg



**350-02322**

**FIAMMA BIKE BLOCK PRO-2 RED FOR CARRY-BIKE (230MM)**

**Specifications**  
Weighs: 0.3kg



**350-02324**

**FIAMMA BIKE BLOCK PRO-3 RED FOR CARRY BIKE (375MM)**

**Specifications**  
Weighs: 0.4kg

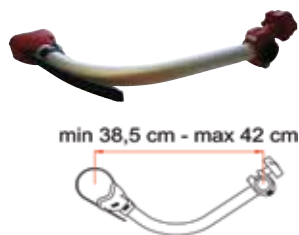

**350-02326**

**FIAMMA BIKE BLOCK PRO-4 RED FOR CARRY BIKE (530MM)**

**Specifications**  
Weighs: 0.5kg



**350-02330**

**FIAMMA BIKE BLOCK PRO D-1**

**Specifications**  
Weighs: 0.6kg

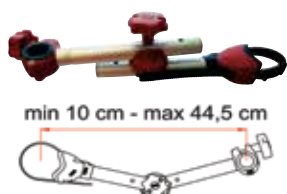

**350-02332**

**FIAMMA BIKE BLOCK PRO D-2**

**Specifications**  
Weighs: 0.7kg



**350-02350**

**FIAMMA CARRY BIKE RACK HOLDER**

A locking system for added security when not carrying any bikes.



**350-02360**

**FIAMMA BIKE BLOCK PRO 1 BLACK**



**350-02362**

**FIAMMA BIKE BLOCK PRO 2 BLACK**



**350-02364**

**FIAMMA BIKE BLOCK PRO 3 BLACK**



**350-02366**

**FIAMMA BIKE BLOCK PRO 4 BLACK**



**350-02503**

**FIAMMA BIKE COVER S 2 TO 3 BIKES (SOLD EACH)**

It adapts to any size load thanks to its adjustable straps. Delivered as standard with transparent pocket to insert the rear signal plate.



## HAYMAN REESE HITCHES

## 350-02521

FIAMMA BIKE COVER  
EXTRA STRONG  
"CARAVAN"

With K-Way system, special version to cover bikes on Carry-Bike CaravanXL A, XL A PRO / E-Bike and Active / E-Bike.



## 350-02530N

FIAMMA CARRY  
BIKE COVER S

Made from lightweight and waterproof polyester, the Bike Cover S has the capacity to cover up to x4 bicycles, thanks to its adjustable straps (with hooks). It comes with a transparent pocket to insert a rear signal plate. Please note, the Bike Cover S is not suitable for bike racks where the bicycles are exposed over the top of the roof.

Weights: 1kg



## 350-05300

## HAYMAN REESE 180LB MINI

The Mini WDS is the solution for towing lighter ball weights such as a trailer. It is a two bar system (19mm diameter) which uses chains to hold the spring bars into position and can be used with any Hayman Reese towbar. It is easily setup and removed and is best suited to trailers with a ball weight up to 80kg.

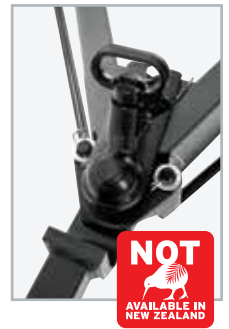

## 350-05310

HAYMAN REESE 285LB  
INTERMEDIATE

The Intermediate WDS is the solution for towing intermediate ball weights such as a camper trailer. It is a four bar system (19mm diameter) which has a working range of between 80kg and 135kg ball weights. The snap up brackets make raising and lowering the chains effortless. There are also triangular plates which allow you to adjust and equalize each pair of bars together.

HAYMAN REESE WEIGHT DISTRIBUTION  
SYSTEMS

Hayman Reese have been Australia's number 1 towing brand for over 60 years and that is why they back their products with a Hayman Reese Lifetime Warranty. Weight Distribution Systems (WDS) restore the geometry of the tow vehicle (such as a ute) to its natural state. A WDS transfers the weight from the rear wheels of the ute to two places: the front wheels of the ute and the wheels of the trailer. To put it simply, a good WDS will level the link between trailer and ute so it is in parallel alignment to the road.

When towing a trailer, the trailer's total ball weight is applied to the rear of your vehicle. When this happens, the front suspension of your vehicle is raised because of the added rear weight. Towing in this way can cause excess swaying of your trailer, reduced steering and breaking responsiveness, less traction and headlights that beam upwards instead of down onto the road in front of you. Over time, you may also experience reduced fuel economy and increased tyre wear (especially on the rear tyres). Hayman Reese have a number of WDS's available to improve control over your vehicle while towing and reducing the amount of sway you experience.

Use the table below to find out which Hayman Reese WDS is best for you:

Ball Weight:	RECOMMENDED WEIGHT DISTRIBUTION SYSTEM				
	Mini	Intermediate	Medium	Heavy	Super Heavy
0-80kg 	✓				
80-135kg 		✓			
135-275kg 			✓		
275-365kg 				✓	
365-545kg 					✓

## 350-05320

HAYMAN REESE 600LB  
STANDARD MEDIUM 30"  
SPRING BARS

The most popular towing aid in Australia which is rated for trailers that have a ball weight of between 135kg and 275kg (suitable for most popular caravans). It has a durable and light cast steel head. Its round, hook style spring bars have integrated cams which are ideal for caravans with 6" deep A-frames. It also features a Hex Cam adjustment washer which allows for up to six head-angle adjustments.



## 350-05330

HAYMAN REESE 600LB  
CLASSIC MEDIUM 30"  
SPRING BARS

Similar to the 600lbs Standard WDS except that the Classic WDS is composed of the Hayman Reese traditional welded head. The Classic WDS has straight, trunnion style, high performance spring bars with integrated cams and an updated lightweight (but extra durable) cast steel shank. Suitable to towing most popular caravans, it has a ball weight capacity of between 135kg and 275kg.



# HAYMAN REESE HITCHES

**350-05340**

## HAYMAN REESE 600LB CLASSIC MEDIUM 28" SPRING BARS

This WDS has all the same features and benefits as the 600lbs Classic Medium WDS above, except that it has slightly shorter spring bars. This is to accommodate caravans or horse floats with a shorter A-frame. It is also suitable for towing most popular caravans and also has a ball weight capacity of between 135kg and 275kg.



**350-05380**

## HAYMAN REESE 1200LB SUPER HEAVY DUTY

The Super Heavy WDS has a working ball weight range of between 365kg and 545kg. Please note however, that if you intend to carry a load in excess of 3,500kg, you will need a 70mm tow ball. Manufactured for serious heavy duty towing, it has a fine tooth adjustment washer which allows for up to nine head-angle adjustments. The drop shank allows for six height adjustments and because of the added weight, Hayman Reese have made it compatible with the Dual Cam HP Sway Control (this is available separately).



**350-05350**

## HAYMAN REESE 800LB STANDARD HEAVY DUTY 30" SPRING BARS

Suitable for towing larger and heavier trailers (such as twin axle caravans), the Standard Heavy Duty WDS relies on heavier gauge spring bars to handle the heavier load. This WDS has a ball weight capacity of between 275kg and 365kg and has 30" hook style spring bars with integrated cams. A Hex Cam adjustment washer allows for up to six head-angle adjustments, while the drop shank allows for up to six height adjustments.



### DROP SHANKS AVAILABLE TO SUIT HAYMAN REESE WEIGHT DISTRIBUTION SYSTEMS

Hayman Reese have a range of Drop Shanks available to setup the system on 4WD's and other vehicles where the lowest/ highest setting is not low/ high enough. Please seek advice from your Coast stockist to check which Drop Shanks are compatible with your vehicle.

**350-05390**

## HAYMAN REESE DROP SHANK - STANDARD

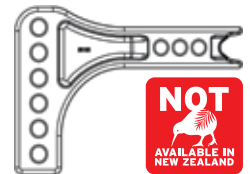

**350-05360**

## HAYMAN REESE 800LBS CLASSIC HEAVY DUTY 30" SPRING BARS

Similar to the 800lbs Standard WDS except that it is composed of the Hayman Reese traditional welded head. The 800lbs Classic WDS has straight, trunnion style, high performance spring bars with integrated cams and an updated lightweight (but extra durable) cast steel shank. Suitable for towing larger twin axle caravans, it has a ball weight capacity of between 275kg and 365kg.



**350-05400**

## HAYMAN REESE DROP SHANK - 30MM



**350-05410**

## HAYMAN REESE DROP SHANK - 95MM

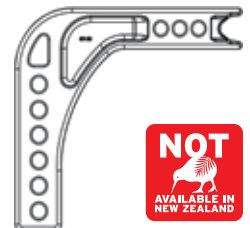

**350-05370**

## HAYMAN REESE 800LB CLASSIC HEAVY DUTY 28" SPRING BARS

This WDS has all the same features and benefits as the 800lbs Classic Heavy Duty WDS except that it has slightly shorter spring bars. This is to accommodate caravans or horse floats with a shorter A-frame. It is also suitable for towing most larger twin axle caravans and also has a ball weight capacity of between 275kg and 365kg.



**350-05420**

## HAYMAN REESE DROP SHANK - 160MM



## EAZ LIFT WEIGHT DISTRIBUTION HITCHES



Over 50 years ago, Eaz Lift became the first patented weight distribution system in North America and is still the most popular WDH in the USA. Coast to Coast has recognised a product that has been tried and tested and now re-developed to suit Australian standards. It has been designed with fewer parts, making it easier to use and install. The Eaz Lift WDHs are constructed from high grade, machine tapered, round spring steel bars and are available in a 600 or 800 series. Both the 600 and 800 series include bolt-together tow ball mounts that are completely adjustable from changing tow ball heights and angles, to suit different application. The left and right sway control mounting facility is already provided should you later require a sway control kit for additional towing comfort and safety. All necessary parts come with each WDH including hook-up brackets, spring bars, chains, tow ball mount, hitch pin and a clip and bolt package for adjusting your hitch. Rated for trailer masses of up to 3.5t. Limited lifetime warranty. Please note shanks are sold separately.

**350-05600****EAZ LIFT 600 SERIES**

For tow ball weights of up to 272kg - for use with a standard 7/8" (22.23) tow ball mounting hole. Shank sold separately

**350-05610****EAZ LIFT 800 SERIES**

For tow ball weights of up to 363kg - for use with a standard 7/8" (22.23mm) tow ball mounting hole. Shank sold separately.





## EAZ LIFT HITCHES

**350-05720****EAZLIFT SHANK SOLID  
ADJ HI-LOW 3 HOLES  
2"X12"L**

The 3 hole shank combines both the LONG and SHORT shank into one unit. Can be used in either the raised or dropped position to match the ball mount to any coupler height.

**Low mounted:** + 45mm lift / + 135mm lift

**High mounted:** + 135mm lift / + 225mm lift

**350-05724****EAZLIFT SHANK ADJ  
EXTRA HI-LOW 3 HOLES  
2"X12"L**

The 3 hole shank combines both the LONG and SHORT shank into one unit. Can be used in either the raised or dropped position to match the ball mount to any coupler height.

**Low mounted:** - 50mm lift / + 40mm lift

**High mounted:** + 225mm lift / + 315mm lift

**350-05728****EAZLIFT SHANK ADJ  
EXTRA LOW ONLY 3 HOLES  
2"X12"L**

The 3 hole shank combines both the LONG and SHORT shank into one unit. Can be used in either the raised or dropped position to match the ball mount to any coupler height.

**Low mounted:**

- 50mm lift / - 140mm lift

**350-05730****EAZLIFT BM35KAR -  
ADJUSTABLE BALL-MOUNT  
ATTACHMENT W/ANTI-  
RATTLE 3500KG**

The EazLift Adjustable Ball Mount is the ultimate height adjustable trailer hitch. It offers a huge range tow ball height adjustment, up to 680mm across EazLift's range of compatible shanks.



*\*Shank not included*

This simple and easy to use adjustable tow shank uses a pin and r-clip system rather than nuts and bolts allowing for effortless installation, adjustment and removal. Designed and tested in Australia, the Adjustable Ball Mount meets and exceeds ADR requirements and is rated up to 3,500kg.

- > Reversible shank and ball platform allow for a huge range of drop or rise heights
- > Up to 40 levels of adjustment across EazLift's range of compatible shanks.
- > 3,500kg Maximum Gross Trailer Mass to cover the biggest vehicle and trailer combinations utilising a 50mm Tow-Ball.
- > Designed, tested and certified for use in Australia.
- > Anti-Rattle Grub Screw
- > Genuine EazLift accessory, it is only recommended & warranted for use with genuine EazLift Shanks only.

**Specifications**

Designed and tested in Australia

Exceeds the design and testing requirements for AS4177.1:2004 and ADR61/02

MAX Rise 302mm when used with EazLift Extra Hi shank (350-05724)

MAX Drop 387mm when used with EazLift Extra Low shank (350-05728)

**Maximum Towball Down Load:** 350kg

**Maximum Gross Trailer Mass:** 3,500kg

## EAZ LIFT HITCHES

SHANK SELECTION GUIDE  
FOR EAZ LIFT WDH'S

**Step 1.** Ensure that both Tow vehicle and Caravan/Horse Float/Trailer are sitting on level ground.



**Step 2.** Level the Caravan/Horse Float/Trailer with the aid of the jockey wheel and take the below measurements.

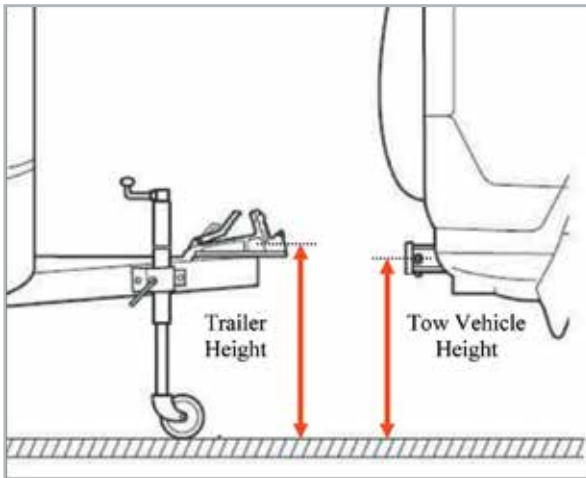

Trailer Height = 445mm  
Tow Vehicle Height = 400mm  
A +45mm lift is required from the Shank.

Example 1			
	445mm	-	400mm = +45mm
Trailer Height		-	Tow Vehicle = Required Lift

Example 2			
	370mm	-	450mm = -80mm
Trailer Height		-	Tow Vehicle = Required Lift

## EAZ LIFT SWAY CONTROLS

Eaz Lift screw on sway controls minimise the sway caused by passing trucks and sudden gusts of wind. It works by using a double friction disc brake principle which provides constant sway reduction and therefore improves handling. They are attached with easy socket and spring clip connectors which also make them easy to remove for convenient storage. The slide bar is zinc plated which ensures consistent smooth gliding action.

Note: Trailers/ caravans over 24' may require two sway controls.

## 350-05800

EAZ LIFT SCREW-ON SWAY CONTROL (DRIVERS SIDE/  
RIGHT HAND MOUNTED)

## 350-05810

EAZ LIFT SCREW-ON SWAY CONTROL (PASSENGER  
SIDE/LEFT HAND MOUNTED)

## EAZ LIFT SPARE PARTS

## 350-05900

EAZ LIFT BALL MOUNT  
FOR 2" SQ SHANK WITH  
LOCK CLIPS

## 350-05901

EAZ LIFT BALL MOUNT  
WITH 1-1/4"  
BALL HOLE

## 350-05902

## EAZ LIFT HITCH PIN



# EAZ LIFT SPARE PARTS

**350-05908**  
EAZ LIFT SPRING BAR 272KG RATING  
(600 SERIES)



**350-05920**  
EAZ LIFT SET SCREW  
FOR 272-363 BALL MOUNT



**350-05909**  
EAZ LIFT SPRING BAR  
363KG RATING (800  
SERIES)



**350-05922**  
EAZ LIFT SPRING BAR LOCKING  
DEVICE REPAIR KIT



**350-05910**  
EAZ LIFT HOOK UP WIRE  
CLIP 2PC FOR 48029



**350-05924**  
EAZ LIFT U-BOLT ONLY FOR CHAIN  
PACKAGE SOLD PER PAIR

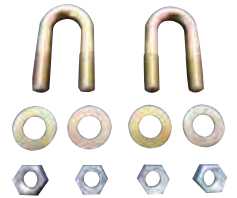

**350-05936**  
EAZ LIFT CHAIN PACKAGE



**350-05925**  
EAZ LIFT SWAY CONTROL  
BALL MOUNT PLATE WITH  
HOLE



**350-05914**  
EAZ LIFT QUICK HOOK-UP



**350-05926**  
SWAY CONTROL BALL, WASHER  
& NUT CLAMSHELLED



**350-05916**  
EAZ LIFT SET SCREW (HOOK-UP)



**350-05928**  
EAZ LIFT LEVEL BAR



**350-05918**  
EAZ LIFT BOLT PACKAGE  
FOR 272-363

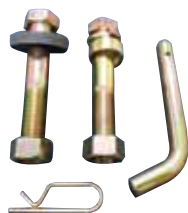

**350-05930**  
EAZ LIFT TRAILER TONGUE  
BALL PLATE



# TIPS FOR SAFER TOWING

## SOME EAZ LIFT WDH QUESTIONS

### How do I work out if I require the 600 or 800 series hitch?

Use the guide below to help you determine what size hitch you need:

- > Determine the ball weight of the trailer - ball weight includes the trailer ball weight with full gas, water, waste systems and a packed trailer.
- > Estimate the car boot load - be sure to include all items carried in the back of the vehicle.
- > Match the sum of these weights to the Correct EAZ-LIFT® Hitch - For example, a ball weight of 500lbs (227kg) coupled with a car boot load of 200lbs (90kg) equates total hitch weight of 700lbs (317kg).

From the guide above, this example of vehicle-trailer combination would require an Eaz Lift 800 Series WDH - 800 Series for weights higher than 272kg and up to 363kg. Make sure the ball weight and the gross trailer weight do not exceed the tow vehicle manufacturer's recommended capacities. The hitch selected must have a maximum Gross Trailer Weight rating equal to or greater than the trailer rating. Ball weight is generally 10% of gross trailer weight.

### Towing Tips

All trailers, including caravans, affect the performance of the towing vehicle. They affect fuel consumption, acceleration, braking ability, general control and maneuverability. These effects worsen as the size and weight of the trailer increase relative to that of the towing vehicle. The extra length and width can be hard to manage, with wind, road roughness and passing vehicles having a greater effect than on the vehicle alone. This puts additional responsibilities on a driver.

The following information applies to vehicles not exceeding 4.5 tons gross vehicle mass (GVM).

### Rules for Towing

- > Towing more than one trailer at a time is not allowed
- > Nobody is allowed to ride in trailers or caravans
- > When towing and driving on a road without street lights, drive at least 60m behind heavy vehicles or other vehicles towing trailers, unless overtaking
- > Learner drivers and learner and provisional motorcycle riders are not allowed to tow
- > P1 car license holders can tow small trailers with up to 250kg of unloaded weight.

### Remember

- > Allow longer distances for braking, overtaking and joining a traffic stream
- > When reversing, it is advisable to have someone outside the vehicle giving directions
- > Look further ahead than normal so you can react to changes in traffic or road conditions
- > Use a lower gear when travelling downhill to increase vehicle control and reduce strain on brakes
- > Slow down well before entering corners and curves
- > Trailers tend to jerk the back of the vehicle around and can cause sway (snaking). If a trailer starts to sway, the vehicle's brakes should not be applied, except as an absolute last resort. If the trailer's brakes can be operated by themselves they should be applied gently, otherwise a steady speed or slight acceleration should be held if possible until the sway stops

- > Take care not to hold up traffic unnecessarily
- > Plan more rest stops and shorter travelling days as towing is more stressful and tiring than normal driving
- > There is no specific speed restriction while towing a trailer. However, the posted speed limits must not be exceeded. Always drive to the road, traffic and weather conditions.

### Before each trip, check

- > Vehicle and trailer are roadworthy.
- > All tyres are properly inflated.
- > Trailer's wheel-bearings, suspension and brakes work properly.
- > All lights work and safety chains are properly connected.
- > Oil, water, brake fluid, battery and other service checks on the vehicle.

### At regular intervals during the trip, check

- > Couplings, all doors, hatches, covers and any load or equipment are still properly secured.
- > If travelling to another State, check with the relevant roads authority whether there are different rules.

### The Towing Vehicle

Vehicles must be suited to the trailer. Vehicle manufacturers usually indicate in the owner's manuals the maximum weight and other features of trailers appropriate for the vehicle. These limits should not be exceeded.

### Registration

- > All vehicles must comply with all relevant standards for registration and be roadworthy at all times
- > Rear number plates and lights must not be obscured by the tow bar when there is no trailer connected.

### Towing vehicles must be properly equipped with:

- > Tow bars and couplings of a suitable type and capacity
- > Electrical sockets for lighting
- > Brake connections if the trailer is fitted with power or electric brakes

### Additionally

- > For vehicles with automatic transmission, an extra transmission oil cooler may be needed
- > Some vehicles need structural reinforcement and/or special suspension and transmission options and load-distributing devices to be able to tow heavier trailers.

### Tow Bar

A properly designed and fitted tow bar is essential for towing. The rated capacity of the tow bar and coupling should not be exceeded.

### The tow bar should be clearly and permanently marked with its:

- > Maximum rated capacity
- > Make and model of the vehicle it is intended for or the manufacturer's part number
- > Manufacturer's name or trade mark.

This is compulsory for vehicles built after 1 January 1992. The exception is where the tow bar is a permanent part of the vehicle.

Tow bars must not protrude dangerously when there is no trailer connected

# TIPS FOR SAFER TOWING

## Load Equalizers

- > Help the vehicle retain normal suspension height and effective steering control
- > Transfer some of the weight from the tow bar to the front and rear suspension of the vehicle.

As load equalizers may overload the tow bar and its components, check with the tow bar manufacturer for advice before use.

## The Trailer

Trailers must be a suitable size and type for their intended tasks. They must be built to meet the standards for registration. If a trailer is required to be registered it must be fitted with a rear number plate.

## Towing Ratio Requirement

**The loaded mass of the trailer must not exceed the lesser of:**

- > Rated capacity of the tow bar and tow coupling.
- > Maximum towing capacity of the vehicle.
- > Maximum carrying capacity of the trailer.
- > Maximum rated carrying capacity of the tyres.

**If the vehicle manufacturer has not specified the maximum towing mass, the maximum towing mass is:**

- > One and a half times the unladen mass of the towing vehicle, provided that the trailer is fitted with brakes which are connected and in working order, or
- > The unladen mass of the towing vehicle if the trailer does not require brakes. Vehicles with a manufacturer's gross combination mass (GCM) more than 4.5 tons may tow in accordance with the above requirements. The GCM is the gross combination mass of the car and loaded trailer.

## Braking System

**The minimum braking system for a trailer depends on the type of trailer, its weight and the weight of the vehicle:**

- > 0 - 750 kg loaded weight - no brakes required.
- > 751 - 2000 kg loaded weight - braking on both wheels on at least one axle.
- > 2001- 4500 kg loaded weight - braking on all wheels, and an automatic breakaway system in case the trailer becomes detached from the vehicle.

Brakes must be operable from the driver's seating position.

## Towing Coupling

**All couplings:**

- > Must be strong enough to take the weight of a fullyloaded trailer.
- > Should be marked with the manufacturer's name or trade mark and rated capacity.
- > Must be equipped with a positive locking mechanism. The locking mechanism must be able to be released regardless of the angle of the trailer to the towing vehicle.

## Safety Chains

- > Must comply with Australian Standards.
- > Trailers less than 2500kg when loaded must be fitted with at least one safety chain.
- > Trailers over 2500kg when loaded must be fitted with two safety chains.

**To prevent the front end of the drawbar from hitting the ground if the coupling is disconnected, safety chains must be:**

- > As short as practicable and connected to the towing vehicle.
- > Crossed over if two chains are fitted.

## Loading Trailers

**It is important that trailers are not overloaded and that loads are properly secured to or contained within the trailer:**

- > A load must not project more than 150mm beyond the trailer's width or be more than 2.5m overall width, whichever is less.
- > Loads that project more than 1.2m behind a trailer must have a red flag attached to the end of the load. This flag must be at least 300 mm square and clearly visible. To avoid having an overhanging load, you should purchase a trailer that suitably contains the load.
- > Overall length of the vehicle and trailer combination including its load must not be more than 19m.
- > To reduce sway, heavy loads should be concentrated towards the centre of the trailer.
- > Loads should be kept as low and as close as possible to the axle or axles with about 60% of the total weight forward of the centre of the axle or axles. As a general rule, about 5-10% of the total mass of the trailer plus load should be supported by the vehicle through the coupling. The trailer drawbar should be level or slightly 'nose down'.

Source:

<http://www.rms.nsw.gov.au/roads/safety-rules/road-rules/towing.html>  
(11 June 2015).

## PEDALBOX ELECTRONIC THROTTLE CONTROLLER RANGE



PedalBox throttle controllers are the newest tool to help you drive smoothly and more effectively. They remove delays in the accelerator to help you manoeuvre your car easily, even when towing or on difficult terrain!

Our throttle controllers alter the acceleration curve on electronic throttle controlled vehicles. They digitally alter the shape of the curve increasing throttle response and improving your overall driving experience. There are four driving modes, Off, Sport+, Sport and Eco/City and each mode can be optimised by a further six levels of curve control. This means that the settings can be adjusted to best suit your driving style.

- > A huge range of cars, 4WDs, vans and trucks supported
- > Improved throttle response for all vehicle types
- > Simple installation and removal—leave no trace
- > Made in Germany for quality guarantee
- > Two year warranty for peace of mind

Part Number	Description
<b>350-13701</b>	PedalBox Throttle Controller For Toyota Hilux/ Fortuner 2.8 CRD. 3701
<b>350-13705</b>	PedalBox Throttle Controller For Ford Ranger-Mazda BT-50 2.5 & 3.0 CRD. 37005
<b>350-13708</b>	PedalBox Throttle Controller For VW Amarok 2.0CRD/Porsche Cayene(All)Ford Territory 2.7CRD

Part Number	Description
<b>350-13735</b>	PedalBox Throttle Controller For Mitsubishi Challenger 2.5CRD/Triton 2.5CRD/Pajero 3.2CRD.
<b>350-13762</b>	PedalBox Throttle Controller For Toyota LC76,78,79 D4-D No Airbag / Hilux D4-D / Prado 120 D4-D / FJ Cruiser. 3762





---

---

---

---

---

---

---

---

---

---

---

---

---

---

---

---

---

---

---

---

---

---

---

---

---

---

---

---

---

---



# SECTION 3

## CARAVAN ACCESSORIES

(Product Group - 400)

Dinnerware	104 - 105
Caravan Accessories	106 - 110
First Aid	110
Table Legs and Components	111 - 112
Picnic Tables	114 - 116
Roof Racks and Accessories	117 - 118
Security Handles	118 - 119
Bed Ends and Storage Pockets	119 - 120
ADCO RV Covers and Tyre Guards	121 - 123
Cleaning Products	123 - 124

---

## CHASSIS EQUIPMENT

(Product Group - 450)

Trail-A-Mate	124 - 125
Jacks and Levels	126 - 129
Jockey Wheels and Accessories	129 - 132
Trailer Locks	132 - 133
Steps	133 - 135
Wheel Spats	136
Hub Kits and Accessories	137 - 138
Bearings and Seals	138 - 140
Level Indicators	141
Heavy Duty Couplings	142
Shackles and Couplings	143 - 144
Corner Steadies	144 - 145
Shackle Pins and Nuts	145 - 146
Tow Ball Scales and Weight Controls	146
Purpleline Levellers and Security	147 - 149
Milenco Levellers	150
Stone Shields	151 - 152



## COAST MELAMINE DINNER SET

## COAST 100% MELAMINE 16PCS DINNER SETS



Great for travelling, these lightweight and chip resistant melamine dinner sets are available in two modern designs. They are not suitable for use in a microwave but they are dishwasher safe (top rack only).

**400-00264****COAST 100% MELAMINE 16PCS DINNER SET - DESTINATIONS**

Set includes 4 of each:

- > Dinner Plates
- > Side Plates
- > Bowls
- > Coffee Cups

**400-00262****COAST 100% MELAMINE 16PCS DINNER SET - DANDELIONS**

Set includes 4 of each:

- > Dinner Plates
- > Side Plates
- > Bowls
- > Coffee Cups



## CAMCO MELAMINE RANGE

The "Life is Better at the Campsite" range is white with a multi-color RV and truck design. The durable dinnerware is great for boats, RVs, and camping. The "Life is Better at the Campsite" range is easy to clean and is top rack dishwasher safe, and BPA free. Do not use in the microwave.

- > Multi-color RV and truck design
- > Melamine construction makes the pieces virtually unbreakable
- > Top rack dishwasher safe and BPA free
- > Perfect for boats, camping and RVs
- > Sold in boxes of 12

**400-00300**  
CAMCO MELAMINE  
BOWL - RV PATTERN



**400-00302**  
CAMCO MELAMINE  
SALAD PLATE  
- RV PATTERN



**400-00304**  
CAMCO MELAMINE  
DINNER PLATE  
- RV PATTERN



The "Life is Better at the Campsite" range is white with a blue tree and truck design. The durable dinnerware is great for boats, RVs, and camping. The "Life is Better at the Campsite" range is easy to clean and is top rack dishwasher safe, and BPA free. Do not use in the microwave.

- > Blue tree and truck design
- > Melamine construction makes the pieces virtually unbreakable
- > Top rack dishwasher safe and BPA free
- > Perfect for boats, camping and RVs
- > Sold in boxes of 12

**400-00306**  
CAMCO MELAMINE  
BOWL - TRAILER/TREE  
PATTERN



**400-00308**  
CAMCO MELAMINE  
SALAD PLATE  
- TRAILER/TREE  
PATTERN



**400-00310**  
CAMCO MELAMINE  
DINNER PLATE  
- TRAILER/TREE  
PATTERN



## CARAVAN ACCESSORIES

**400-90000N**  
**BOATIES FRYPAN**

Designed for use in RVs where stove and cooking space is limited, the Boaties Frypan has a rectangular shape and is made of heavy gauge aluminium. This, combined with a double layer of non-stick coating, creates a quality frypan with excellent heat transfer and even cooking temperatures. The handle is compact and has an ovenproof (max oven temperature: 220°C) silicone grip—remember to take care as the grip will get very hot! The front edge is conveniently sloped whilst the rounded corners make pouring liquid contents easy. Suitable for use on gas, electric and induction hobs.

**Specifications**

**Dimensions:** 25L x 20W x 4.5H (cm)

**400-90010N**  
**BOATIES BAKING PAN**

The Boaties Baking pan has all the same structural features as the Boaties Frypan (above) except that it is slightly larger and has a detachable silicone grip handle. With the Boaties Baking pan, you're able to roast and bake. Meals can be prepared on the stove top and then transferred to the oven for cooking.

**Specifications**

**Dimensions:** 21L x 31W x 6D (cm)

**400-90020N**  
**BOATIES FRYPAN LID**

The Boaties Frypan Lid is made from stainless steel and is suitable for use on the Boaties Frypan only. It stops splatter and enables the Frypan to be used as a stovetop casserole dish. It also features a handy steam vent.

**400-00495**  
**FIAMMA EASY DRY**

Suitable for use with any Fiamma Carry Bike, the Easy Dry is quickly installed onto the rail support base, without the need to drill anything. It can also be used on other bike carriers, provided their tube diameter is 35mm. The Easy Dry is a great option to dry towels or swimmers as they come with plasticized ropes and the width is adjustable for slightly larger items. It is made from anodized aluminium with a 22mm diameter, making it sturdy but lightweight. Has eight lines.

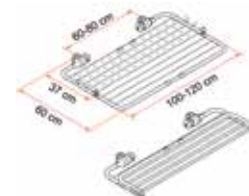
**Specifications**

**Length (cm):** Adjustable from 100 - 120

**Closed Width (cm):** 37

**Open Width (cm):** 60

**Weight (kg):** 1.2

**400-00530**  
**RV & MARINE MINI DISH DRAINER**

Fits RV sinks & is sized just right for limited counter space. Its sloped drainer tray keeps counters dry. When your dishes are dry, simply snap the drain tray back onto the top of the rack for handy storage. Made from a durable, heavy duty plastic it even has space for utensils.

**400-00546**  
**CAMCO STACK-A-PLATE**

The Stack-A-Plate keeps your plates tidy and safe during travel. It features a non-slip backing thus eliminating movement whilst stowed in your RV's cupboard. Made from plastic, the Stack-A-Plate is available in bright white and is even safe for the top rack of your dishwasher. Comes as a two-piece set - the larger of which fits plates up to 26cm in diameter and the smaller one fits plates up to 18.4cm in diameter.



**400-00642**

**POP-A-BAG HOLDER**

Stores grocery bags efficiently. The plastic bag holder/ dispenser mounts easily onto walls or inside cabinets with screws or double-sided tape. Comes in white & holds up to 25 grocery bags.



**400-00692**

**DOUBLE FRIDGE BAR**

Keep order in your RV's fridge whilst travelling. These spring-loaded bars keep items in place and extend from 406 - 711 (mm).

**Specifications**

Weight: 295g

Dimensions: 19D x 102W x 476H (mm)



**400-00650**

**ADJUSTABLE BROOM WITH CLIP ON DUST PAN**

Full size broom telescopes down to store compactly. Soft-bristled head adjusts to different angles for maximum cleaning power. The handle length is adjustable from 61 - 132(cm) & the dustpan clips onto the broom handle for storage.



**400-00694**

**REFRIGERATOR BARS**

These are x3 single bars that act in the same manner as the Double Fridge Bar (above).

**Specifications**

Weight: 349g

Dimensions: 17D x 92W x 594H (mm)



**400-00654**

**RV FOLDING IRONING BOARD**

A wooden tabletop ironing board with fabric cover that is small & easy to use. It features a sturdy chrome-wire iron rest & measures 81L x 30W (cm) when set up for use.



**400-00686**

**CAMCO FRIDGE AIRATOR WITH ON/OFF SWITCH**

Camco RV Fridge Airator helps to cool the RV fridge evenly and keeps your food fresher. The Fridge Airator features a high-volume air circulator that absorbs odours with replaceable activated charcoal pack. Battery operated. Version with on/off switch available for easy use.



- > Absorbs odors with activated charcoal
- > Keeps food fresher by cooling your fridge evenly
- > On/off switch saves battery life
- > Perfect for any small sized refrigerator
- > Replaceable charcoal pack included
- > Runs on two size D batteries (not included)

**400-00656**

**RV WALL MOUNT TRASH CAN**

A compact trash can that can be mounted onto a wall or inside a cabinet. Features a handy swing-top lid & comes with screws for mounting.



**Specifications**

Dimensions: 13W x 28H (cm)

**CAMCO FRIDGE ACCESSORIES**

**400-00690**

**FRIDGE BRACE**

Keep food from sliding as you travel. The Fridge Brace helps to keep cartons upright to reduce the risk of messy spills. Comes in a pack of 2.



**Specifications**

Weight: 145g

Dimensions: 73D x 130W x 135H (mm)

**400-00688**

**CAMCO FRIDGE AIRATOR CHARCOAL PACKS**

Fridge Airator Replacement Charcoal Packs. Replace the charcoal pack monthly to stop odours and keep your Camco Fridge Airator working efficiently.



## CARAVAN ACCESSORIES

**400-00696****CAMCO MINI ICE CUBE TRAY PACK OF 2**

Small trays fit perfectly into RV or marine freezers. Provides small size cubes for quick freezing.

**Specifications**

Length: 22.86cm

Width: 10.16cm

Height: 2.54cm

**400-00850****FIAMMA SOAP DISPENSER**

A 200ml refillable liquid dispenser ideal for soap or shampoo. The container is transparent which helps to identify when you're running low. Its heavy duty push style pump ensures no mess with every use.

**Specifications**

Dimensions: 150H x 8D x 55W (mm)

**FLAT OUT STORAGE REELS**

Flat Out Storage Reels were made for the harsh Australian environment. They are the ideal storage solution for electrical leads or any of the Flat Out Hoses. Made from a grey, impact resistant plastic, they feature a turning handle (to assist with winding up) & a grip handle for comfortable carrying. Great for domestic, travelling & even the construction industry, they come with a Flat Out limited 3 year guarantee.

**400-00700****FLAT OUT MULTI-REEL**

Can hold one of the following:

- > 40m of heavy duty power lead
- > 18m of flat drink water hose
- > 9m of flat sullage hose
- > 375 x 80 (mm)

**400-00710****FLAT-OUT BARE COMPACT-REEL**

Can hold one of the following:

- > 20m of heavy duty power lead
- > 12m of flat drink water hose
- > 7m of flat sullage hose
- > 300 x 65 (mm)

**400-00800****FIAMMA OMNI STOP**

An innovative yet simple accessory, ideal for keeping plates & items in place as you travel. Easy to lock & unlock, the securing bar is made from anodized aluminium & is 25cm high. The support handle is made from a sturdy plastic & is 20cm long.

**400-00900****FIAMMA MOSQUITO NET FOR MOTORHOMES & CARAVANS**

The mosquito net consists of two overlapping panels, each being 230 x 35 (cm). The bottom of each panel is reinforced & stays taught. It is easily installed by sliding into the wall track provided.



# CARAVAN ACCESSORIES

## POLE CARRIERS & ACCESSORIES

**400-01100**  
**POLE CARRIER (200CM X 15CM)**

Comes with a pair of mounting brackets - great storage place for fishing rods, annexe poles or even cable for the humble tradie.



**400-01102**  
**POLE CARRIER (200CM X 10CM)**

Comes with a pair of mounting brackets.



**400-01110**  
**SINGLE BRACKET (150MM)**

For pole carrier - sold separately.



**400-01120**  
**POLE CARRIER END CAP**

To suit 400-01100



**400-01130**  
**POLE CARRIER END PIN ASSEMBLY**

To suit 400-01100 (15cm diameter)



**400-01132**  
**POLE CARRIER END PIN ASSEMBLY**

To suit 400-01102 (10cm diameter)



**400-01140**  
**SINGLE BRACKET (100MM)**

To suit pole carrier (suits part number 400-01102) - sold separately.



## COAST CARRIERS

If you're tired of wrapping cable or hose around your elbow to tidy up an area and then worry about where to store it, then the Coast range of Carriers is what you need. Made from a durable mesh and a vinyl front, each bag comes with a convenient handle to either hang somewhere for storage or for easy transportation. Available in 3 sizes.

**400-01510**  
**ELECTRIC CABLE CARRIER**

Holds up to 20m of cable

**Specifications**

Dimensions: 270mm Diameter



**400-01520**  
**DRINK WATER HOSE CARRIER**

Holds up to 20m of drink hose

**Specifications**

Dimensions: 345mm Diameter



**400-01530**  
**GREY WATER HOSE CARRIER**

Holds up to 10m of grey water hose (with 27mm diameter)

**Specifications**

Dimensions: 440mm Diameter



## CARAVAN ACCESSORIES

**400-02210****1KG ABE FIRE EXTINGUISHER**

Australian standard approved, this fire extinguisher is rechargeable & lightweight. It has a mounting bracket for convenient storage & is suitable for use in vehicles, boats, RV's, residential, garages, workshops & the like.

**Specifications**

Fire rating: 1A1ØBE

Range of discharge: 3-4m

**400-02260****MINI FIRST AID KIT**

Contains all the essentials: a first aid leaflet, a pair of latex gloves, a towel dressing, antiseptic wipes, non adherent dressing, a crepe bandage, gauze swabs & splinter forceps.

**400-02292****CARAVAN & RV OWNERS HANDBOOK WALLET**

- > Professional, sleek all black document wallet.
- > Perfect way to store owner manuals, receipts, cards & service logs
- > Cheap, presentable way to bundle in all handover paperwork
- > Clear plastic pockets for business cards and elastic pocket for A4 documents.

**400-02220****FIRE BLANKET**

Suitable for cooking & clothing fires the blanket measures 1 x 1m

**400-02250****FIRE EXTINGUISHER HOLDER MAPLE**

Made from a 3mm ABS plastic this holder is a suitable housing for the 1kg Fire Extinguisher (part number: 400-02210). The cavity measures 135W x 345H x 95D (mm).

**400-02252****FIRE EXTINGUISHER HOLDER WHITE**

The white version of the extinguisher holder above.

**400-02254****FIRE EXTINGUISHER HOLDER BLACK 3MM ABS PLASTIC**



# TABLE LEGS & COMPONENTS

**400-02310**

**WINEGLASS TABLE LEG COMPLETE WITH BASE & TOP**

Popular table leg which stands 70cm tall. Comes in 4 parts - top plate, tube, bottom plate & anchor (which is bolted to the floor for extra stability). Powder coated in a neutral beige paint.



## TABLE LEGS

**400-02400**

**SWING AWAY TABLE LEG**

Comes complete with base & top. Has a sturdy construction with a chrome finish. Stands 73cm high.



## FIAMMA TABLE LEGS & PARTS

**400-02362**

**FIAMMA TABLE LEG TRIPOD PRO**

A newly reinforced and more stable tripod promoting carrying the table outside. Made from UV resistant plastic, it comes standard delivered with an anti-closing device.



**400-02402**

**EAZY LIFT TABLE LEG**

A height adjustable table leg with an adjustable collar for specific heights. Functioned by a single gas strut & requires 22kg to compress or increase height.

**Specifications**

Height Range: 48 - 85.5 (cm)



**400-02364**

**FIAMMA TABLE LEG RECESSED BASE**



**400-02403**

**EAZY LIFT TABLE LEG WITH ROUND PLATE**

All the same features as 400-02402 (above) but now comes with a round base plate.

**Specifications**

Height Range: 48 - 85.5 (cm)



**400-02366**

**FIAMMA CONIC TOP MOUNT CONNECTION**

Made of aluminium & supplied with self threading fixing screws.



**400-02409**

**WING NUT HANDLE FOR SWING AWAY TABLE LEG**



**400-02368**

**FIAMMA RECESSED BASE PLUG**

Covers the hole in the centre of the recessed base - part number 400-02364.



**400-02412**

**V-TYPE TABLE LEG**

Stands 705mm in height & has x4 predrilled screw holes.



**400-02370**

**FIAMMA TABLE LEG TUBE PRO (70CM)**

This new leg is made of anodized aluminium with a 70cm max extension. It comes with 2 plastic joint caps.



**400-02414**

**TABLE SUPPORT LEG - 305 (MM)**



## TABLE LEGS &amp; COMPONENTS

400-02416

TABLE SUPPORT LEG - 355 (MM)



400-02418

TABLE SUPPORT LEG - 457 (MM)



400-02420

PLASTIC HINGE

To suit 400-02414, 400-02416 and 400-02418.



400-02422

WINE GLASS EXTENSION  
IN GREY HAMMER-TONE  
(140MM)

Suitable for use on an existing straight table leg, this extension converts a normal table top to a swivel table top. Simply remove the existing table top (and plate), and place the extension piece into the top of the existing table leg. Tighten the wingnut to secure the extension piece into place. Refit the table top (and plate) on the extension piece. Fits all table legs with a 45mm tube diameter.

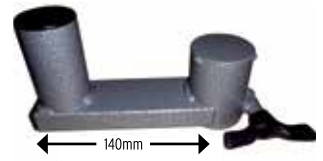

400-02424

WINE GLASS EXTENSION  
IN GREY HAMMER-TONE  
(215MM)

Suitable for use on an existing straight table leg, this extension converts a normal table top to a swivel table top. Simply remove the existing table top (and plate) and place the extension piece into the top of the existing table leg. Tighten the wingnut to secure the extension piece into place. Refit the table top (and plate) on the extension piece. Fits all table legs with a 45mm tube diameter.

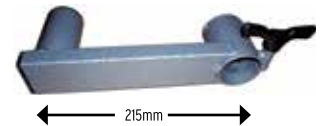

**FIND YOUR  
NEAREST  
STOCKIST**

Over 300 independent  
stockists throughout  
Australia & New Zealand

Find your nearest stockist at [coastrv.com.au](http://coastrv.com.au)

# NUOVA MAPA TABLE LEG & SLIDE

## NUOVA MAPA TABLE LEG AND SLIDE



The Nuova Mapa table leg is a fully adjustable telescopic table leg with turntable and slide system. This table can be easily adjusted into bed position if required. The bed position is factory set at 330mm and can be easily adjusted if another measurement is required.

### 400-02600

#### NUOVA MAPA TELESCOPIC AND ADJUSTABLE TABLE LEG (WITH TURNTABLE/SLIDING TABLETOP MECHANISM)

Encompassing ease and versatility, this revolutionary table leg is made in Italy from galvanised steel. Its spring loaded leg, can be lowered by pressing on the foot pump at the base and pushing down on the table top. Raising the table top is just as simple - press the foot pump again. The table top mechanism, made from lightweight aluminium, facilitates movement in and out of the dining area. A lift lever allows the table top to swivel up to 180°, as well as in a N, S, E or W direction.

#### Specifications

Diameter of leg base: 260mm

Max Weight Capacity (in bed position): 100Kg

Max Height (from floor to underside of table top): 710mm

Min Height (from floor to underside of table top): 330mm



### 400-02602

#### NUOVA MAPA BLACK ADJ HEIGHT TABLE LEG WITH TURN TABLE & SLIDE



### 400-02610

#### NUOVA MAPA SLIDING TABLE TOP MECHANISM

Suitable for use on existing Wineglass table legs, the Sliding Mechanism retrofits in place of the standard (and immovable) table top mount.



#### Specifications

Dimensions: 445W x 705L (mm)

## COAST PICNIC TABLES



We all know storage space is at a premium whilst you're travelling, so taking the essentials (like tables and chairs) can sometimes be a pain. Why not install a picnic table on the outer wall of your RV? It's one less thing you have to pack and you can never leave it behind! Quick and easy to install, the Coast Picnic Tables feature powder coated, stainless steel hinges and are rated to a huge 30kg\*. The table itself is made from SMC (sheet moulding compound) which is the same material used by Audi and Porsche! Available in white, the Coast Picnic Tables are suitable for installation on fibreglass and aluminium cladded RVs (note that in the case of aluminium cladded vans, the Picnic Table with Backing Plate must be installed). Comes with 2 keys so that you can lock your table in a "closed" position when not in use.

*\*Whilst the Coast Picnic Tables are rated to hold 30kg, you should ensure that the structure you're fitting it onto (i.e. aluminum cladding or fibreglass paneling) can hold that weight. Coast recommends that you: 1) Check with your RV's manufacturer, prior to installation, how much weight the walls will hold. 2) Ensure you do not exceed the weight that your RV manufacturer has recommended.*

#### 400-02700 PICNIC TABLE (WITH BACKING PLATE)

The backing plate creates a neat frame between the two fixed brackets on the picnic table. It Allows for extra mounting points should there not be any supporting studs behind the spot you've chosen to install it.



##### Specifications

Weight: 4.7Kg

Dimensions: 805L x 435H x 30D (mm)

#### 400-02720 PICNIC TABLE (WITHOUT BACKING PLATE)

##### Specifications

Weight: 4.2Kg

Dimensions: 805L x 435H x 30D (mm)



# COAST PICNIC TABLES

## 400-02730 PICNIC TABLE WHITE C/W CHROME LOCK

Includes backing plate.

### Specifications

Dimensions: 800 x 450 (mm)



## 400-02732 PICNIC TABLE BACKING PLATE C/W 3M TAPE WHITE

To suit 400-02730

### Specifications

Dimensions: 800 x 450 (mm)



## 400-02740 PICNIC TABLE BLACK WITH CHROME LOCK

Includes backing plate.

### Specifications

Dimensions: 800 x 450 (mm)



## 400-02742 PICNIC TABLE BACKING PLATE WITH 3M TAPE BLACK

To suit 400-02740

### Specifications

Dimensions: 800 x 450 (mm)



## CARAVAN PICNIC TABLE WITH LED LIGHTING & BACKING PLATE

Now featuring bright LED lighting, Coast Picnic Tables are quick and easy to install on fibreglass or aluminium cladded vans. They feature powder coated stainless steel hinges, full size backing plate, chrome locks and have a 25Kg weight rating.

- > Integrated 12V LED Lighting
- > 304 Stainless Steel Locks
- > Improved Drainage with 12 Drain Slots

## 400-02800 CARAVAN PICNIC TABLE BLACK 4RC WITH LED LIGHTING & BACKING PLATE

### Specifications

Dimensions: 800 x 445 (mm)



## 400-02802 CARAVAN PICNIC TABLE WHITE 4RC WITH LED LIGHTING & BACKING PLATE

### Specifications

Dimensions: 800 x 445 (mm)



## 400-02804 CARAVAN PICNIC TABLE RAL7037 GREY 4RC WITH LED & BACKING PLATE

### Specifications

Dimensions: 800 x 445 (mm)



## 400-02805 CARAVAN PICNIC TABLE SOJL25678 LIGHT GREY 4RC WITH LED & BACKING PLATE

### Specifications

Dimensions: 800 x 445 (mm)



## TABLE HINGES

CARAVAN PICNIC TABLE  
WITH BACKING PLATE**400-02820**  
CARAVAN PICNIC TABLE  
BLACK 4RC & BACKING  
PLATE

## Specifications

Dimensions: 800 x 445 (mm)

**400-02822**  
CARAVAN PICNIC TABLE  
WHITE 4RC & BACKING  
PLATE

## Specifications

Dimensions: 800 x 445 (mm)

**400-02824**  
CARAVAN PICNIC TABLE  
RAL7037 GREY 4RC &  
BACKING PLATE

## Specifications

Dimensions: 800 x 445 (mm)

**400-02826**  
CARAVAN PICNIC TABLE  
SOJL25678 LIGHT GREY  
4RC & BACKING PLATE

## Specifications

Dimensions: 800 x 445 (mm)



## TABLE HINGE KITS

**400-02900**  
TABLE HINGE KIT

Allows you to easily &amp; quickly remove a table top. Kit includes: x1 metal rod (70cm), x2 plastic rod ends, x1 plastic bracket, x1 plastic bracket locator &amp; x2 plastic removable hinges. Suitable for bi-fold tables.

**400-02994**  
L PIECE FOR TABLE  
HINGE KIT**400-02995**  
TUBE + CENTRAL PLASTIC CLAMP  
FOR TABLE HINGE**400-02997**  
CENTRAL PLASTIC CLAMP  
(2 PART)  
FOR TABLE HINGE KIT**400-02998**  
CENTRAL ATTACHMENT  
FOR TABLE HINGE KIT**400-02999**  
PLASTIC END BRACKET  
FOR TABLE HINGE KIT

## COAST ADJUSTABLE ROOF RACKS

Designed to suit most campers, Coast to Coast's Adjustable Roof Racks can be resized to fit almost any installation requirement.

Now there is room to take your surfboards, canoe or kayak on your next adventure, even if you already have a roof mounted A/C or TV antenna!

### Features

- > Easy Multi-fit DIY Roof Rack Kit
- > Can be shortened in both length and width to suit your requirements.
- > Cross bars can be positioned to allow for roof top accessories.
- > Each kit comes complete with the brackets for both roof and side mounting options.
- > Stylish low profile design is available in Black.
- > Lightweight and durable
- > Made from tubular aluminum.
- > Weight rated to 100kg\*
- > Complete with all required fitting and detailed installation instructions.

### Specifications

Weight: 20kg  
 Maximum Load: 100kg\*  
 Maximum Length: 3745mm  
 Maximum Width: 2300mm  
 Height: 140mm

*\* Please consult your camper manufacturer for roof load limit*

### 400-04602 COAST ADJUSTABLE ROOF RACK BLACK

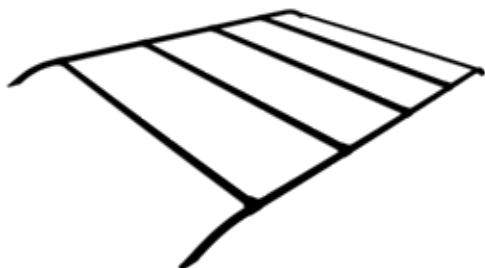

## LUGGAGE BASKET

Suitable for Jayco and Coast roof racks, this handy luggage basket greatly expands the amount and type of cargo you can safely transport on your next RV adventure. Made from lightweight and durable tubular aluminum the basket is supplied preassembled with all required fittings for an easy installation.

### Specifications

Weight: 12kg  
 Maximum Length: 1500mm  
 Maximum Width: 1000mm  
 Height: 200mm

### 400-04610 ALUMINIUM LUGGAGE BASKET WHITE



### 400-04612 ALUMINIUM LUGGAGE BASKET BLACK



## ROOF RACK CROSS BAR KIT

An extra cross bar with all required fixtures to add extra support to existing Jayco Roof Racks. Kit contains 4 brackets (1pair), 4 nuts and bolts and 1 cross bar. The bars are 2300mm long and can be cut to the correct length.

### 400-04614 ALUMINIUM CROSS BAR PACK FOR ROOF RACK WHITE



### 400-04616 ALUMINIUM CROSS BAR PACK FOR ROOF RACK BLACK



## BIKE RACKS

Coast to Coast's range of Bike Racks feature a compact and sturdy design, excellent quality, well thought-out usability and outstanding value.

Coast Bike Racks are supplied pre-assembled for easy DIY installation and are specially designed to suit both Jayco and Coast to Coast adjustable roof racks.

Coast Bike Racks are an affordable and convenient solution to take your bikes with you on your next trip.

#### 400-04650 COAST ALU STAR BIKE RACK

- > For upright assembly
- > Can be mounted to both Jayco and Coast Roof Rack Systems
- > Fast and easy installation by means of plastic hand wheels.
- > For 1 bike up to 133cm wheelbase and 80mm frame diameter
- > Supplied with extra mounting brackets that also suit car roof racks



##### Specifications

Load capacity: 15kg

Weight: 2.15 kg

#### 400-04652 COAST SUPER BIKE RACK

- > For upright assembly
- > Can be mounted to both Jayco and Coast Roof Rack Systems
- > Plastic hand wheels for fast and easy installation
- > Suitable for bikes frames up to a width of 80mm
- > For almost all tyre widths, from racing bikes to mountain bikes
- > Swivel catch on the lockable toggle screw
- > Adjustable wheel holder trays with protective plastic end caps
- > Supplied with extra mounting brackets that also suit car roof racks



##### Specifications

Load capacity: 15kg

Weight: 2.9 kg

## FIAMMA SECURITY HANDLES

A handle designed to lock across the main door to provide extra security & also double as a grab handle to get into your caravan comfortably. Available in two sizes.

#### 400-03010 FIAMMA SECURITY 31 HANDLE (WHITE)

Made with solid painted aluminium with 30mm diameter & 2mm thickness. Takes up little space when folded against the wall. Comes complete with key lock & safety release handle, installation brackets, screws & internal counterbrackets.



#### 400-03020 FIAMMA SECURITY 46 HANDLE (WHITE)

Has all the same features as the Security 31 Handle but with a longer handle extension.

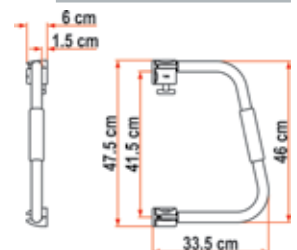

#### 400-03090 FIAMMA DOOR HOLDER GREY

Prevents the door to your RV from swinging open/ closed when windy.

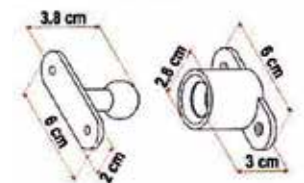



# SECURITY HANDLES

## CAMCO RV GRAB HANDLES

The Camco RV Grab Handle is a simple, efficient way to make entering and exiting your RV safer. After the one-time, easy installation, the Camco RV Grab Handle provides a secure hand-hold on the left or right side of your RV door. When not in use, the Grab Handle easily lifts and rotates to lay flat against the side of the RV. The durable aluminum construction with UV resistant plastic brackets is built to last. Use the Camco RV Grab Handle to replace your old or broken grab handle, or to install on an RV that has never had a grab handle. All installation hardware is included.

- > Provides a secure hold for entering and exiting your RV
- > Easily installs to the side of any RV
- > Ergonomic design provides solid, secure grip
- > All installation hardware included
- > Durable and weather resistant

### Specifications

Height: 72.9cm

Width: 37.6cm

Depth: 6.1cm

### 400-03030 CAMCO FOLD AWAY GRAB HANDLE - BLACK



### 400-03032 CAMCO FOLD AWAY GRAB HANDLE - WHITE



### 400-03054 FIAMMA SECURITY SAFE DOOR WHITE



### 400-03530 TOYLOK W/15FT CABLE + PADLOCK

Scavengers are everywhere. ToyLok's tamper-resistant design keeps your gear safe while you're away. Thanks to ToyLok, your belongings will be there when you get back.



### Specifications

- > Easy, bolt-on installation
- > Built-in clutch prevents cable snap while retracting
- > 15 feet of PVC coated, anti-abrasion cable
- > Internal breaking and pulley system allows users to choose their optimum length of cable
- > 8,000 pound rated cables ensures your gear stays safe
- > Keys, padlock and mounting hardware included

## BED END GARAGES

Suitable for use on most brands of camper trailers, these Bed End Garages allow you to make use of otherwise wasted space. It keeps items such as the kid's toys, BBQs, canoes and even the humble porta potti hidden! No drilling, screwing or stitching is required to create this PVC enclosure. Heavy duty Velcro connects the walls to the underside of your folded out bed end. Tent pegs are provided to secure the Bed End Garage to the ground and access can then be gained using the zipper. Available in white in two models - on-road and off-road.



### 400-04500 CAMPER BED END GARAGE FOR ON-ROAD CAMPERS

#### Specifications

Overall Dimensions: 4500L x 1400H (mm)

### 400-04510 CAMPER BED END GARAGE FOR OFF-ROAD CAMPERS

#### Specifications

Overall Dimensions: 4500L x 1650H (mm)

## FIAMMA STORAGE POCKETS

## FIAMMA STORAGE POCKETS

**400-05000****FIAMMA STOW-ALL POCKET M**

Made of scratch resistant plastic & is easy to install with the provided screws. Available in white only.

**400-05004****FIAMMA STOW-ALL POCKET L**

Made of scratch resistant plastic & is easy to install with the provided screws. Available in white only.

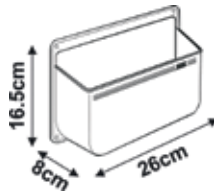
**400-05010****FIAMMA STOW-ALL POCKET XL**

A practical storage pocket that is easily installed onto doors or walls with screws provided. Made of scratch resistant ABS & is available in grey only.

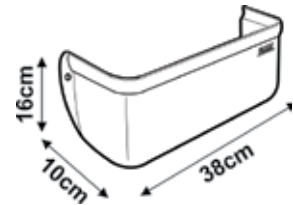

## TRAVELLERS TWIN PET BOWLS

These travellers pet bowls feature folding legs that lock for space saving storage while on the road and height adjustment when in use.

The frame is made of ABS plastic, the bowls are removable stainless steel and the feet are silicone for grip. The top surface features a handy design that prevents food from spilling over or can be filled with water to create a moat keeping ants from reaching the bowls.

**TRAVELLERS TWIN PET BOWL - HEIGHT ADJUSTABLE - BLACK****300-06100****TRAVELLERS TWIN PET BOWL - HEIGHT ADJUSTABLE - GREY****300-06104**

For more RV Storage Solutions see Page 065

# ADCO RV COVERS

## ADCO RV COVERS

Australia and New Zealand has seen the new era of RV protection, thanks to the American RV cover giant ADCO making their newest Designer Series covers exclusively available from Coast to Coast.

Backed by a huge 3-year warranty, the ADCO Designer Series Olefin HD™ RV Cover is available to suit Camper Trailers, Caravans, Pop Tops and Motorhomes. They're designed for high sun exposure, high moisture, long term storage and even snow, making it the most durable cover on the market! It features superior UV stabilised and breathable fabric that blocks out 99.8% of the suns damaging UV rays. On the Caravan, Pop Top and Motorhome models, there are zippered panels along one side. These allow you access to the interior of your RV whilst the cover is on, and because of the eyelets on these panels, they can also double as an awning!



### Features

- > Top panel is made of Olefin HD™ fabric. This new proprietary fabric has outperformed other leading roof materials and beads water on contact. Some water may penetrate the cover in heavy rains.
- > Side panels are made of four layers of polypropylene with a soft lining that won't scratch your RV paintwork.
- > A cinching system with buckles prevent billowing fabric on the front and rear.
- > The lining of the cover is reinforced on all corners to protect against tears caused by sharp edges.
- > Air vents help to eliminate moisture build-up.

### ADCO CAMPER COVERS

Fits Camper Trailers up to 86" (2.18m) wide and 54" (1.37m) high.



Part Number	Description
<b>400-06500</b>	10' - 12' (3.06 - 3.67m)
<b>400-06502</b>	12' - 14' (3.67 - 4.28m)
<b>400-06504</b>	14' - 16' (4.28 - 4.90m)

### ADCO CARAVAN COVERS

Fits Caravans up to 104" (2.64m) wide and 93" (2.36m) tall.



Part Number	Description
<b>400-06510</b>	14' - 16' (4.28 - 4.90m)
<b>400-06512</b>	16' - 18' (4.90 - 5.51m)
<b>400-06514</b>	18' - 20' (5.51 - 6.12m)
<b>400-06516</b>	20' - 22' (6.12 - 6.73m)
<b>400-06518</b>	22' - 24' (6.73 - 7.34m)
<b>400-06520</b>	24' - 26' (7.34 - 7.92m)

### ADCO POP TOP COVERS

Fits Pop Tops up to 101" (2.57m) wide and 71" (1.80m) high



Part Number	Description
<b>400-06522</b>	12 - 14' (3.67 - 4.28m)
<b>400-06524</b>	14' - 16' (4.28 - 4.90m)
<b>400-06526</b>	16' - 18' (4.90 - 5.51m)
<b>400-06528</b>	18' - 20' (5.51 - 6.12m)

### ADCO MOTORHOMES COVERS

Fits Motorhomes up to 104" (2.64m) wide and 93" (2.36m) tall



Part Number	Description
<b>400-06530</b>	20 - 23' (6.12 - 7.01m)
<b>400-06532</b>	23' - 26' (7.01 - 7.92m)
<b>400-06534</b>	26' - 29' (7.92 - 8.84m)

# ALL CLIMATE

ALL CLIMATE  
**DESIGNER SERIES**  
OLEFIN HD™ RV COVER

by **ADCO**  
AUSTRALIA

**ALL CLIMATE | WATER RESISTANT | 4 LAYER | HIGHLY BREATHABLE**

## 1) Highly Protective 4 Layer Olefin HD™ Roof Panel

- Proprietary fabric has outperformed other leading roof materials
- Maximum protection against damaging UV rays
- Water resistant yet breathable
- Beads water on contact

## 2) Dual Front & Rear Cinching System

- Removes slack and removes billowing

## 3) All Corners Reinforced

- Protects against tears caused by sharp edges

## 4) Eyelets In Hem

- Easily convert entry doors into a sun awning  
(Excludes Camper Trailer)

## 5) Air Vents

- Help to eliminate moisture build-up  
(Excludes Camper Trailer)

## 7) Door Flaps Double As Sun Awning

(Excludes Camper Trailer)

## 8) Polypropylene Side Panels

- Breathable & durable  
4 layers

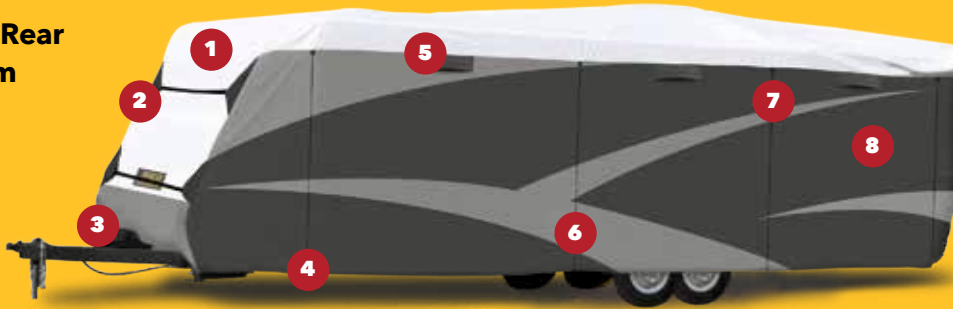

**POP TOP, CAMPER TRAILER, CARAVAN, OR CLASS C MOTORHOME**



### Front and Rear Cinching System

Removes slack and reduces billowing



### Olefin HD™ Roof Panel

Effectively blocks 99.8% of the sun's damaging UV rays and beads water on contact

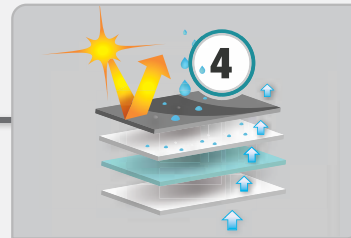

### Four Layer Top & Sides

Allows cover to breathe while resisting moisture



### Passenger-Side Zipper Entry Doors

for easy covered access, regardless of door position  
(Excludes Camper Trailer)



### Air Vents

Help the cover to breathe and prevent mould and mildew  
(Excludes Camper Trailer)

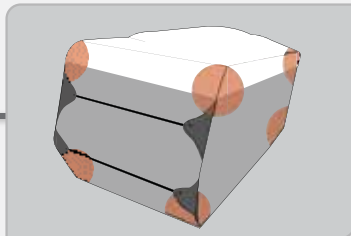

### Extra Reinforcements

On all four top & bottom corners help protect against sharp edges & reduces wear



### Weighted Buckle Toss-Under

Allows you to easily toss the installation straps under your RV to connect to the opposite side



### Storage Bag Included

Easily store your cover when it is not in use



SUN



RAIN



SNOW

## OLEFIN HD™

Superior UV stability effectively blocks 99.8% of the sun's damaging UV rays that can fade interior & exterior surfaces

# ADCO RV COVERS

## ADCO ULTRA TYRE GUARDS

- > Protect your vehicle's tyres from blowouts
- > Durable heavy-duty flannel backed vinyl repels liquid and saves tyres from the sun's damaging UV rays and other environmental hazards
- > Overlapping seams, double needle stitching and reinforced grommets
- > Eliminate premature cracking of sidewalls
- > Bungee-ball fastening system eliminates loss to wind
- > Two Tyre Guards per box

**400-06200**

**ADCO TYRE GUARD  
WHITE 30"- 32"**

**400-06202**

**ADCO TYRE GUARD  
WHITE 27"- 29"**



## ADCO TYRE COVER DIAMOND PLATE

- > Protects spare tyres from damage caused by UV rays and other elements
- > Prevents rubber from damage and cracking which can cause popping and punctures
- > Super heavy-duty vinyl construction
- > Designed to look and feel like diamond plated steel
- > Elasticized rear seam for a snug fit
- > Bottom drainage to prevent moisture buildup
- > UV and cold crack treatment

**450-06300**

**ADCO TYRE COVER  
DIAMOND PLATE  
29 3/4"**

**450-06302**

**ADCO TYRE COVER  
DIAMOND PLATE 27"**

**450-06304**

**ADCO TYRE COVER  
DIAMOND PLATE  
25 1/2"**



## PREMIER ONE CLEANING PRODUCTS

If you've ever found giving your RV a good clean bit of a mission, Premier One have come up with a great, practical idea! Telescopic, industrial strength poles that have a screw-end to attach a brush head. The brush head has super soft, non-abrasive fibres on it... so you don't have to worry about scratching the paint work on your RV.

**There are two types of telescopic options available:**

- > A non-flow through pole, with a comfortable safety grip
- > A flow through pole, with a comfortable safety grip.

This one is particularly useful because you can attach hose to it, allowing water to flow through the pole and onto the brush head. There is also an "on/ off" switch at the end of the pole so that you're able to minimise water wastage.

These poles and brushes are great for use on your RV or around the home, cleaning those hard to reach windows is now a breeze. Also great for the marine, transport and manufacturing industries.



**400-05100**

**PREMIER ONE QUAD  
BRUSH HEAD**



**400-05110**

**PREMIER ONE BI-LEVEL  
BRUSH HEAD**

Two-sided, contoured brush head. Soft bristles that are safe to use on all vehicles and designed to get into difficult spots.



**400-05200**

**PREMIER ONE NON FLOW POLE**

Made from lightweight aluminium, the non-flow through pole extends up to 2.5m



**400-05300**

**PREMIER ONE FLOW THROUGH POLE**

Made from lightweight aluminium, the flow-through pole extends up to 2.5m. It also has an on/off feature built into the handle to limit water wastage.



## CLEANING PRODUCTS

**400-05340****PREMIER ONE CARAVAN WASH 5L BOTTLE**

Premium caravan wash, works in conjunction with the Premier One Foam Gun. This high foaming, PH neutral and environmentally formula is perfect for any dirty RV.

**400-05350****CAMCO RV WASH PODS - 6 PER PACK**

Camco's easy to use RV Wash Drop-Ins help wash away years of built up dirt and grime on your RV. One convenient, premeasured drop-in dissolves in 11.3 liters of water that can then be used to scrub away at your RV. The re-sealable bag of 6 drop-ins is more lightweight than most liquid or gel cleaners, making it easy to take with you on the road. Cleaner is biodegradable, fragrance-, phosphate- and SLS-free and contains no added dyes.

**OUTBACK'S RV SUPER WASH**

This product has been specially formulated to dissolve iron ore and red dirt quickly and efficiently without using dangerous chemicals or damaging the sensitive surfaces on your RV or Caravan. It is made with an acid-free, environmentally sustainable solution that can be used safely on a wide range of surfaces from painted to plastic to aluminium.

RV Super Wash is a highly versatile product that can be used on any surface of your Vehicle making it the ideal solution for the keen travellers making their way across the expansive landscape.

**400-05360****OUTBACK'S RV SUPER WASH - 750ML****400-05362****OUTBACK'S RV SUPER WASH - 5L****TRAIL-A-MATE****450-00060****TRAIL A MATE HYDRAULIC JOCKEY WHEEL AND JACK KIT**

Specifically designed for use with a caravan chassis, the Trail A Mate provides a unique way of making the hitching and unhitching of your caravan or camper trailer very easy (no matter how low your caravan or camper trailer might be). By removing the pin, the wheel can be replaced by the base plate and an adjustable clamp, thus turning the jockey wheel into a jack. The kit includes: hydraulic jack on shaft, lifting clamp, jockey wheel, base plate with pin, lifting handle, bracket and bars, and a comprehensive instruction guide.

**450-00085****TRAIL A MATE MARK II HYDRAULIC JACK ONLY**

A heavy duty jack designed for lifting large caravans, boats and trailers. It comes with a base that enables the Mark II to be used not only as a lifting device but also as a jack stand. Manufactured to Australian and New Zealand standard 2693/2007, it has a lift capacity of up to 35cm.

**Specifications**

Working Load Limit: 1500kg

Aggregated Trailer Mass: 3500kg

\* Does not include A-Frame Clamp



## TRAIL-A-MATE

**450-00087****TRAIL-A-MATE JACK COVER**

Keep your Trail-A-Mate jacks in the best possible condition with the Trail-A-Mate Jack Cover. The cover ensures thorough protection all year round from the harsh Australian elements. Made from heavy duty all-weather material, the high-quality construction is made to last.

**450-00089****TRAIL A MATE 60MM CLAMP FOR MARK II HYDRAULIC JACK**

An optional clamp to enable you to use the Mark II Hydraulic Jack as a jockey wheel instead of having it permanently fixed to your RVs frame.

**450-00940****TRAIL-A-MATE JOCKEY WHEEL CLAMP ANTI-THEFT LOCK**

Brand new, easy to install anti-theft lock by Trail-A-Mate. Designed to secure their popular Hydraulic Trailer Jacks. This anti-theft device protects your expensive jockey wheels such as Trail-a-Mate or any jockey wheel from being stolen, features:

- > Converts a standard jockey wheel clamp into a lockable clamp
- > Fits in minutes
- > Comes complete with dust cap

**450-00102****COAST JACK PADS (80MM)**

Made with a durable plastic construction, Coast's Jack Pads are easy to attach. They have a universal fit & a unique channel that prevents ants from crawling up the stabilizer legs. Comes in a set of 4 & includes 4 anti-rattle sleeves.

**Specifications**

Dimensions: 158L x 138W x 74H (mm)

**450-00118****STABILISER JACK PADS**

Prevent your jacks or awning legs from sinking into grass or sand. Interlocking for convenient storage with a handy velcro strap. Built in handle for ease of use. Solidly constructed of a durable polypropylene with UV filters & comes in a set of 4.

**JACK LEVELLING BASES****450-00120****ALKO BIG FOOT CARAVAN JACK**

Alko Big Foot Caravan Jack Steady "Foot" - Anti sinking bases for the bottom of jack legs, comes in a set of 4. 1.0: 80mm

**450-00121****ALKO SINGLE FOOT PIECE**

Single Foot Piece to Suit Alko Big Foot Caravan Jack Steady.

**450-00127****FIAMMA PLATES PRO (GREY)**

A set of four anti-sinking bases with four plastic pins to fasten to the RVs drop down legs. They can be a permanent fit if required, simply leave the pin in place.

**450-00132****FIAMMA PLASTIC STAKKA JACKS (GREY)**

Made from UV-resistant plastic, these grey plastic jacks have an adjustable height (from 31 - 44 cm). Comes in a set of four jacks, each weighing 0.8kg. Each jack has a max load of 750kg.



# LEVELLING SYSTEMS

## 450-00152

### RUBBER JOCKEY WHEEL RECEIVER

Acts as a chock for your jockey wheel. Has raised edges to ensure your jockey wheel does not roll once it is in the stationary position.



## 450-00160

### ALUMINIUM STABILISING TRAILER JACK

Features a heavy duty non-corroding, cast aluminium base with steel screw assembly & a permanent handle. Each jack has a weight capacity of 2721kg. Comes in a set of 4.



## CAMCO WHEEL CHOCKS

Solidly constructed of durable hard plastic with UV inhibitors, these yellow chocks are ideal for caravans & motor homes. They are sold separately & are available in two sizes.

## 450-00210

### WHEEL CHOCK

Suitable for wheel diameters of up to 26" (66cm).



## 450-00220

### SUPER WHEEL CHOCK

Suitable for wheel diameters of up to 29" (74cm).



## 450-00232

### CAMCO TRAILER AID PLUS

Trailer-Aid is the fast, safe and easy way to change a trailer's flat tyre. Made from lightweight super strong polymer, Trailer-Aid is easy to travel with and makes changing your trailer tyre simple, even if you're alone. Trailer-Aid Plus is designed specifically for recreational trailers and gives an additional 1 inch lift. The extra 1inch lift makes Trailer-Aid Plus handy when performing maintenance on brakes, wheels, and axles.



#### Specifications

Dimensions: 610L x 140W x 139.7H (mm)

Holds up to 6,800kg.

## FIAMMA LEVEL SYSTEMS

## 450-00260

### MAGNUM LEVELS

Lightweight blocks to level your RV that won't crack like wood. It has a self-locking overlapping system & has a max axle weight of 8t. Comes in a set of 2.

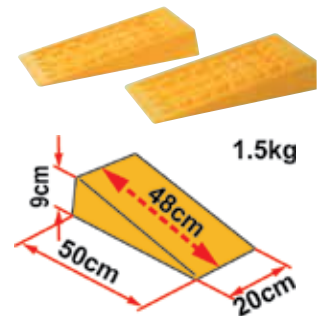

## 450-00262

### JUMBO LEVELS

Ideal for RV's with twin tyres, the jumbo system also has the overlapping feature & has a max axle weight of 14t. Comes in a set of 2.

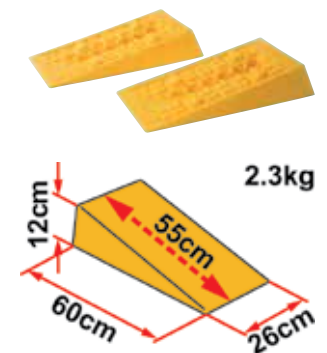

## 450-00273

### FIAMMA LEVEL BAG



#### Specifications

Dimensions: 185 x 245 x 650 (mm)

## 450-00274

### LEVEL PRO

Now available in grey, the Level Pro is great for caravans or trailers with small wheels (up to 145mm tread width). Made from HDPE that is also UV-resistant, they have a max axle weight of 5t. They can also be stacked on top of each other if the need for extra height arises. Comes in a set of 2.

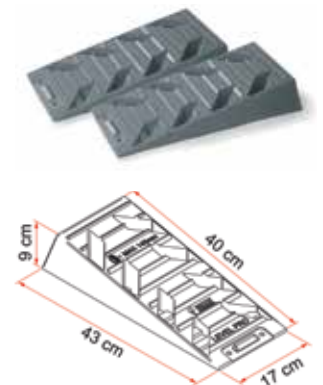

#### Specifications

Weight: 0.8kg each



# LEVELLING SYSTEMS

## 450-00276

### LEVEL-UP RAMPS

Fiamma's bestselling ramps are now available in grey. They are still lightweight, strong and anticorrosive, making these the best levelling choice for your RV. The Level Up has 3 levels with a ridged surface to grip the tyres in place. They have a max axle weight of 5t and come in a set of 2.

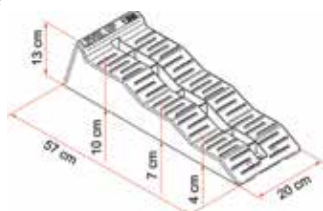

#### Specifications

Weight: 1.45kg each

## 450-00278

### ANTI-SLIP PLATE

Now available in grey, these anti-slip plates lock onto a Fiamma ramp to provide extra grip for your RV tyres. It is especially handy on paved surfaces. Weighs just 100g and is available as a set of 2.



#### Specifications

Dimensions: 100W x 160L (mm)

## 450-00279

### FIAMMA CHOCKS FOR FIAMMA LEVELS (GREY)

Sold in pairs, chocks are used with Level Ups, Level Pros or Level Magnums to secure the wheels during long stopovers. They come with steel hooks and are solidly made from UV-resistant polyethylene.



## 450-00280

### FIAMMA LEVEL BAG S

A smaller version of the Level Bag (part number 450-00273), the Level Bag S is suitable for use with Level Pros and Level Magnums.



#### Specifications

Dimensions: 150H x 220W x 570L (mm)

## 450-00304

### CURVED LEVELER AND WHEEL CHOCK

- > Easy drive-on leveller adds up to 4" (101mm) in height
- > Honeycomb design makes leveller lightweight but durable
- > Included chock has non-slip rubber grippers on the bottom
- > Compact length makes leveller compatible with tandem wheel spacing without modification



## EXPLORE LEVELLING SYSTEM

## 450-00396

### EXPLORE CVL2 LEVELLING RAMP (PAIR)

Made in Australia and specifically designed for tandem axle trailers, these levellers have a 5 tonne capacity. Super strong, they're able to raise a wheel up to 100mm (without the use of a jockey wheel)! They feature an extra wide tread to cater for tyre widths of up to 250mm and are lightweight at just 1.8kg each.



#### Specifications

Dimensions: 140H x 570L x 250W (mm)

## 450-00398

### WHEEL CHOCKS TO SUIT CVL2 LEVELLING RAMPS



## 450-00399

### STORAGE BAGS FOR CVL2 LEVELLING RAMPS

Designed specifically for the CVL2 range, the storage bag is made from tough polyester with a PVC backing. Each bag will fit a set of CVL2 levellers and a set of wheel chocks.



## COAST RED LEVELLERS



Essential for all Caravanners, Coast's range of RV levelling solutions, highly visible they are made from UV resistant polypropylene to withstand prolonged outdoor use.

**450-00460****COAST RED STD SINGLE WHEEL LEVEL & CHOCK KIT**

Each kit comes with 1 x wheel ramp with grip spikes, 1 x chock to suit and 1 x anti-slip plate. Comes with a carry bag.

- > Highly Visible
- > Rated to 2 ton
- > Includes handy storage bag
- > Level ramp has a solid base with anti-slip spikes which means that it will not sink into soft ground
- > Anti-Slip plate clips onto the leading edge of the level ramp
- > Manufactured from tough UV resistant polypropylene plastic for superior strength
- > Kit includes level, chock and anti-slip plate, with bonus storage bag
- > Two ramps can link together side by side. Ideal for Dual Axle Motorhomes

**Specifications**

Level ramp dimensions: 520mm (l) x 200mm (w) x 125mm (h)

Chock dimension: 150mm (l) x 120mm (w) x 100mm (h)

**450-00462****COAST RED SINGLE MULTI LEVEL RAMP**

Each pack contains:  
x1 Tri-Level Wheel Ramp

- > High visibility
- > Each level has three different heights
- > Rated to 2 ton
- > Includes a handy storage bag
- > Made from UV-resistant polypropylene
- > Helps to level caravans or motorhomes on uneven ground
- > Lightweight
- > 3 height levels 4, 7 & 10 cm
- > Anti-slip surface for extra grip
- > Suitable for vehicles up to 2 ton

**Specifications**

Level ramp dimensions: 610mm (l) x 210mm (w) x 120mm (h)

**450-00464****COAST RED STD SINGLE WHEEL CHOCK**

Suitable for use with the standard wheel ramp part number 450-00460. These are sold singularly.

**Specifications**

Chock dimensions: 150mm (l) x 120mm (w) x 100mm (h)



# JOCKEY WHEELS

**450-00466****COAST RED TYRE SAVERS  
2-PACK**

- > Prevents flat spots on your tyres
- > Suitable for tyres with diameters from 10" to 20"
- > Works with most types of security wheel clamp
- > Suitable as a "Stop" by bolting to garage floor
- > Suitable for use with caravans, trailers & any vehicle that is stationary for long periods
- > Two ramps can link together side by side. Ideal for Dual Axle Motorhomes

**Specifications**

Tyre Saver dimension: 440mm (l) x 200mm (w) x 40mm (h)

**COAST RED TREAD AND STORE****450-00490****COAST RED TREAD  
AND STORE - FOLDING  
COMBINATION RECOVERY  
BOARDS & STORAGE BOX**

- > Set of folding vehicle recovery boards
- > Provides traction if stuck in sand, mud or snow
- > Doubles as a heavy-duty storage box
- > Hinged lid for easy access to stored content

**COAST JOCKEY WHEELS**

Coast to Coast's range of quality jockey wheels is now available. Perfectly suited for most caravan, trailer and horse float applications, this new range has all of your jockey wheel needs sorted.

The range features three jockey wheel size variants from 6" to 10". The smaller wheels are ideal for use on paved and hard surfaces while the 10" wheels allow for even soft ground surfaces to be navigated safely. Each jockey wheel size is available with the choice of standard or swivel clamp. The swivel clamp allows the jockey wheel to be quickly and conveniently rotated out of the way when your hitched up and ready to hit the road.

Coast Jockey Wheels come individually packaged in shipping cartons while additional standard clamps are available in retail packaging. Don't miss out, stock up on these exceptional value Jockey Wheels today.

**450-10000****COAST 6" JOCKEY WHEEL  
+ STD CLAMP****Specifications**

Capacity: 340kg  
Lifting height(mm): 254  
N.W: 4.5kg

**450-10002****COAST 6" JOCKEY WHEEL  
+ SWIVEL CLAMP****Specifications**

Capacity: 340kg  
Lifting height(mm): 254  
N.W: 6kg

**450-10004****COAST 8" JOCKEY WHEEL  
+ STD CLAMP****Specifications**

Capacity: 340kg  
Lifting height(mm): 254  
N.W: 6.3kg

**450-10006****COAST 8" JOCKEY WHEEL  
+ SWIVEL CLAMP****Specifications**

Capacity: 340kg  
Lifting height(mm): 254  
N.W: 7.5kg

**450-10008****COAST 10" PNEUMATIC JOCKEY  
WHEEL + STD CLAMP****Specifications**

Capacity: 340kg  
Lifting height(mm): 254  
N.W: 6.2kg

**450-10010****COAST 10" PNEUMATIC JOCKEY  
WHEEL + SWIVEL CLAMP****Specifications**

Capacity: 340kg  
Lifting height(mm): 254  
N.W: 7.5kg



# JOCKEY WHEELS

**450-10020**  
**COAST STD JOCKEY**  
**WHEEL CLAMP**  
**(50MM/750LBS)**



## ALKO JOCKEY WHEELS

**450-00600**  
**ALKO 6" JOCKEY WHEEL**

Has a standard clamp with a solid rubber tyre (150D x 50W mm).



**450-00610**  
**ALKO 6" JOCKEY WHEEL**

Has a locking pin swivel bracket with a rubber tyre (150D x 50W mm).



**450-00620**  
**ALKO 8" JOCKEY WHEEL**

Has a standard clamp with a rubber tyre (200mm diameter) & steel rim.



**450-00632**  
**ALKO 10" JOCKEY WHEEL**

Has a standard clamp with a solid tyre (250mm diameter), suitable for softer ground thanks to the larger wheel diameter.



**450-00642**  
**ALKO 10" JOCKEY WHEEL**  
 has a large locking pin swivel bracket with a solid tyre (250mm diameter).



**450-00644**  
**ALKO THRUST BEARING**  
 Used on 6", 8" and 10" Alko jockey wheels and power mover.



**450-00646**  
**ALKO JOCKEY WHEEL HANDLE**  
 Suitable for pin-type handles.



**450-00660**  
**ALKO POWER MOVER**

Has a ratchet mechanism for added convenience & a solid tyre (250mm diameter).



**450-00684**  
**ALKO 6" SOLID**  
**RUBBER WHEEL**



**450-00686**  
**ALKO 8" SOLID**  
**TYRE WHEEL**



# JOCKEY WHEELS

**450-00698**

## SOLID RUBBER TWIN JOCKEY WHEEL (WITH CLAMP)

Perfect for using in combination with your caravan or trailer mover and is suitable for use with single axle and dual axle trailers. The benefit of using the Twin Jockey Wheel is that it does not dig in or jam up on surfaces like some single jockey wheels. It greatly improves the operation on a single and dual axle caravan/ trailer mover regardless of the caravan/ trailer weight. The Twin Jockey Wheel has a heavy duty clamp and the wheels are 10" solid rubber. The tyre has a steel centre with a bronze bush bore while the jockey wheel itself is zinc plated to deter rust.



### Specifications

Weight: 17kg

Lift Capacity: 225mm

Static Load Capacity: 1000kg

## JOCKEY WHEEL CLAMPS

**450-00669**

## ALKO PREMIUM WIDE CLAMP



**450-00700**

## STANDARD BOLT ON CLAMP

(no swivel function) to suit jockey wheel.



**450-00702**

## ADJUSTABLE SWIVEL JOCKEY WHEEL BRACKET

Has a locking pin swivel function (150H x 210W mm).



## WINDER HANDLES

**450-00711**

## SLOTTED STYLE WINDER HANDLE TO SUIT REAR JACKS

### Specifications

Length: 700mm (including the handle)

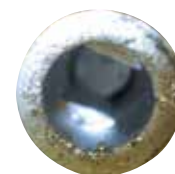

**450-00712**

## HEX STYLE WINDER HANDLE TO SUIT CORNER JACKS

### Specifications

Length: 800mm (including the handle)



**450-00714**

## HEX WINDER HANDLE

### Specifications

Length: 1150mm (including the handle)



## ARK JOCKEY WHEELS

**450-00720**

## 150MM (6") STANDARD WHEEL

Has a locking swivel u-bracket & a 350kg load capacity.

### Specifications

Maximum Extension: 250mm



**450-00722**

## 200MM (8") STEEL RIM RUBBER WHEEL

Has a locking swivel u-bracket & a 350kg load capacity.

### Specifications

Maximum Extension: 250mm



# JOCKEY WHEELS

## 450-00742

### ARK XO SERIES JOCKEY WHEEL

Ark's new Extreme Off road Series (XO) Jockey Wheel is probably the toughest, most advanced Jockey Wheel in Australia today. But not only is it tough, it's also versatile - with multiple height options, a highly maneuverable trailing yoke design and 5 different yoke locking positions.

- > Magnetic, removable, side-winding handle
- > Heavy duty body with 750kg rating
- > 4 x adjustable height positions
- > Heavy duty swivel clamp
- > Dual wheel with sealed bearings & off road tread
- > Rust resistant finish



## 450-00750

### 6" SOLID RUBBER WHEEL TO SUIT JOCKEY WHEEL

#### Specifications

Wheel diameter: 140mm

Tread width: 40mm



## 450-00910

### TRAILER COP ANTI-THEFT COUPLING LOCK

The ball type anti-theft trailer lock that prevents thieves from towing your trailer away by expanding in your coupler. Suitable for use on 50mm couplers, it takes just a minute to install.



## 450-00924

### KOVIX TRAILER HEAVY DUTY PADLOCK

Built for maximum security, this unique alarmed trailer lock is the ultimate deterrent to would-be thieves. Designed by Kovix Australia the heavy duty KTR-18 alarmed trailer lock is made from 304 grade stainless steel. Resistant to impact, drilling and cutting this ultra-strong trailer lock features an 18mm pin with an anti-cutting sleeve.

This smart lock's alarm can be turned on or off and is triggered by a motion sensor that activates the 120dB alarm for 10 seconds. The lock is rust resistant and its electronics are water proof so it can be left out in the elements. Built to suit standard 50mm ball hitches, Off Road D035 and Treg-style block hitches, the KTR-18 is as versatile and smart as it is tough.

#### Features

- > Anti-Impact and Drill Resistant
- > Weatherproof Electronics (IP67)
- > Removable Ball to Fit a Wide Range of Hitches
  - (H 100mm x W 155mm x D 35mm - Inside W 80mm)
- > Built in Loud Alarm - Sounds at 120dB
- > Long Life 3V Lithium Battery Included
- > Double Locking Pin System



## 450-00932

### KOVIX D035 COUPLING LOCK

Protect your caravan, camper or boat with this purpose-built lock for the D035. Unique Features:

- > Fits the D035 coupling
- > Weather resistant
- > Ultra-Strong. Heavy duty, 304 stainless steel construction
- > 18mm locking pin
- > Anti-impact, saw and drill resistant



## 450-00927

### MILENCO SECURITY PIN LOCK T/S D035 PIN COUPLING

- > Secures your RV
- > Complete with plastic storage case
- > Made from Heavy Duty Steel
- > Integrated high security lock
- > Fast and simple to fit
- > Compact and lightweight
- > Variable height setting



## STEPS

**MILENCO SECURITY CABLE**

- > Coated braided stainless steel cable
- > Secure your valuables- Bicycles, BBQ, Portable Fridge
- > Integrated combination security lock
- > Fast and Simple to Fit
- > Compact and Lightweight design
- > Combination lock - set your own code.

**450-00928**

6m

**450-00929**

10m

**450-00926****MILENCO AUSTRALIAN HITCHLOCK WITH CHAIN LOCK**

- > Tough and dependable steel
- > Clamps over tow ball and secured chains
- > Complete with 3 Keys

**450-00931****DUAL TRAILER COUPLING LOCK HEAVY DUTY - INC. PADLOCK**

Secure your parked caravan to the towing vehicle and secure it even when its not attached to a vehicle,

**Features**

- > Heavy duty coupling lock
- > Works when hitched and unhitched.
- > Simple and easy to use
- > Supplied with high-quality padlock
- > Suits Australian 50mm ball couplings
- > Suitable for use with caravans, trailers and horse floats

**450-01050****CAMCO FOLDING STEP**

Holds up to 136kg (300lbs) & has a large non-slip surface. Folds flat for easy storage (grey).

**450-01070****MGI MILENCO GIANT SINGLE STEP - 200KG RATED**

Features a giant tread area that strictly meets safety guidelines to allow a safe carry load of 200kg, skid resistance, and a tread that is non-slip, even when wet. Produced using 100% recycled plastic.

**Specifications**

Tread Size: 455mm x 363mm

Height: 265mm

Weight: 1.7kg

**450-01072****MGI MILENCO DOUBLE STEP - 200KG RATED**

Emphasizes safety with non-slip tread and highly skid-resistant upper tread surface for maximum safety in both wet and dry conditions. Fitted with four rubber feet to prevent skidding on asphalt and peg holes for use on grass.

**Specifications**

Tread Size: 360mm x 220mm

Height: 185mm x 365mm

Weight: 2.9kg

**450-01104****COAST FOLDING ALUMINUM RV STEP (220KG CAPACITY)**

This folding aluminium RV Step features a light weight and sturdy design and can support up to 220kg. It has anti-slip strips and grippy rubber feet for extra stability.

**Specifications**

Folded size: 47.5 x 30 x 7cm

Open size: 47.5 x 30 x 22.5cm

Net weight: 2.2kgs

**450-01106**  
**COAST HEIGHT**  
**ADJUSTABLE - FOLDING**  
**ALUMINUM RV STEP**  
**(150KG CAPACITY)**

This folding aluminium RV Step features a light weight and sturdy design and can support up to 150kg. It has anti-slip strips, grippy rubber feet for extra stability and adjustable feet that offer four height adjustments.



**Specifications**

Folded size: 48.5x36.8x7cm

Open size: 18.5 - 19.8 - 21 - 22.5cm

Net weight: 2.6kgs

**450-01405**  
**SINGLE PULL-OUT**  
**CARAVAN STEP**



**Specifications**

Step Width: 514mm

Tread Depth: 180mm

Closed Dimensions: 300D x 530W x 180H (mm)

Mounting plate to top of step: 145mm

**450-01415**  
**DOUBLE PULL-OUT**  
**CARAVAN STEP**



**Specifications**

Bottom Step Width: 520mm

Bottom Step Tread Depth: 180mm

Top Step Width: 510mm

Top Step Tread Depth: 305mm

Closed Dimensions: 380D x 590W x 310H (mm)

Mounting plate to top of step: 180mm

Mounting plate to the top of bottom step: 305mm

**450-01530**  
**FIAMMA PLASTIC STEP**  
**SMALL**

Step in & out of your RV safely! Has a non-skid surface & is made from UV resistant HD polyethylene. Holds up to 150kg & comes in grey.

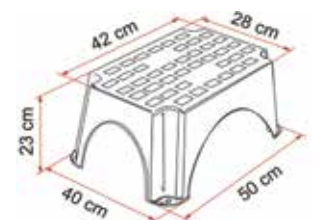

**450-01552**  
**FIAMMA MAGNUM PLASTIC**  
**STEP**

An improved version of Fiamma's best selling step. Made from UV resistant HD polyethylene for great stability & strength. Comes in grey & can hold up to 200kg.

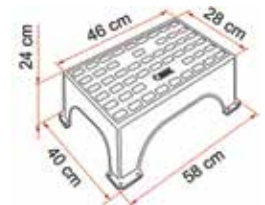

**450-01570**  
**FIAMMA CLEAN STEP**

Suitable for use on electric or manual steps, it helps to keep your RV clean. Made from durable plastic it has a grass appearance & is supplied with springs for installation. Can be adapted to fit steps from: 380 x 400mm up to 450 x 400mm. Available in green.

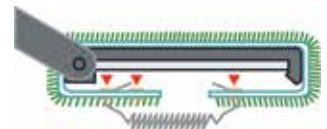

**450-01990**  
**WHEEL NUT**

Wheel nut for alloy rim



**Specifications**

Dimensions: 1/2" thread diameter with a 2mm pitch



## STEPS

**450-02020****COAST SPARE WHEEL CARRIER 6 STUD SILVER**

Coast to Coast very own Spare Wheel Carrier to suit popular 4, 5 and 6 stud wheels. Ideal for caravans, campers, horse floats and all trailers.

**Features**

- > Heavy duty galvanized spare wheel mount
- > Suits 4, 5, and 6 stud wheels
- > Comes ready for easy installation and simple use
- > Designed to fit 4 and 5 inch A frames.

**NUOVA MAPA ELECTRIC STEPS**

This series of innovative electrical steps are made from galvanised steel for durability & stability. The footrests are made with anodized aluminium (so they won't rust) & are spaced at a comfortable height for your convenience. Order separate wiring loom as required.

**450-02100****12V SINGLE ELECTRIC STEP****Specifications**

Step Width: 575mm  
Step Tread Depth: 210mm  
Step Weight: 7.8kg  
Step to Mounting Plate: 197mm

**450-02110****12V DOUBLE ELECTRIC STEP**

Order separate wiring loom as required.

**Specifications**

Step Width: 575mm  
Step Tread Depth: 210mm  
Step Weight: 11.7kg  
Bottom Step to Top Step: 200mm Top  
Step to Mounting Plate: 197mm  
Width from center hole to center hole on the mounting plate: 530mm

**450-02120****WIRING HARNESS WITH AUTO CLOSE ON IGNITION**

If you forget to close your step, on ignition of your vehicle, the step will close automatically.

**450-02130****STANDARD WIRING HARNESS WITH SWITCH**

A standard in/ out switch which can be installed near the entry to engage or disengage the step.

**450-02140****MANUAL SINGLE STEP**

Made with the same quality and precision as the electric steps, the Manual Single Step holds up to 200kg. It requires minimal effort to open or close as it is spring loaded.

**Specifications**

Step Width: 560mm  
Step Weight: 5.5kg  
Step to Mounting Plate: 197mm

**450-02150****SPRINGS FOR MANUAL STEP**

Sold in pairs.

**450-02300****RV WRAP AROUND STEP RUG (GREY)**

Adjusts to fit almost any RV step. Just wrap it around your existing step & hook springs into the holes that fit your step. No screws, glues or tools needed! Helps to keep your RV clean.



## WHEEL SPATS

## WHEEL SPATS

**450-01690****JAYCO STARCRAFT  
SINGLE WHEEL SPAT**

White (sold singularly)

**450-01692****JAYCO WESTPORT  
SINGLE WHEEL SPAT**

Metallic blue (sold singularly)

**450-01694****JAYCO EARLY HERITAGE  
DOUBLE WHEEL SPAT**

White (sold singularly)

**450-01696****JAYCO WESTPORT DOUBLE  
WHEEL SPAT**

Metallic blue (sold singularly)

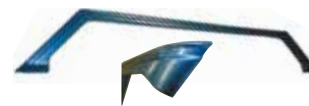
**450-01698****JAYCO FREEDOM  
SINGLE WHEEL SPAT**

White (sold singularly)

**450-01699****JAYCO LATE MODEL  
HERITAGE DOUBLE WHEEL  
SPAT**

White (sold singularly)

**450-02498****JERRY CAN HOLDER**

Has a lockable chain.

**450-02500****ADJUSTABLE JERRY CAN HOLDER**

Designed to fit many jerry can sizes &amp; has an anti-theft adjustable locking bar.

**450-02510****WELD ON JERRY CAN HOLDER**

An economical solution to jerry can storage, this metal strap type holder is zinc plated to help minimise the occurrence of rust.

**Specifications**

Dimensions: 370W x 180L x 295D (mm) Weight: 3kg

## LCI LIPPERT ELEC-BRAKE HUB DRUMS

Lippert Components Brake Drum Hub Assemblies are an industry standard. Lippert Trailer hub assembly (hub and drum) provides surface area for brake shoes to grip when brakes are activated and are compatible with standard axles from most manufacturers.

LIPPERT Brake assembly plates feature a bushed oval magnet. This feature comes as standard and for good reason as the bush provides added protection against dust. In a standard magnet dust intrusion quickly builds up and provides a friction point for the magnet and causes accelerated wear.

**Electric Brake Hub Drums**

The hub drum is what connects the trailers wheels to the trailers axle and houses the wheel bearings. The hub drum is the part that rotates and inside this drum sits a stationary electric brake assembly plate containing the braking shoes and magnet. The Hub also provides a steel inner face for the magnet to stick onto when powered. When this happens, the shoes are activated and they expand out to grip the inner walls of the rotating drum providing friction which in-turn drastically slows down the spinning drum.

Due to the magnet dragging on the inner-face of hub-drum they wear out. They can be machined to provide a flat surface for the magnet to comfortably adhere to but eventually you will need to simply replace them. Electric Hub drums also feature bearings so they can be attached as one unit to your axle and have the wheel studs already fitted so you can easily attach them to your wheels - both bearings & wheel stud PCD's will vary depending on what they are suited for.

**450-11002****LCI LIPPERT 10" ELEC-BRAKE HUB DRUM  
- 6-STUD LANDCRUISER PCD****450-11004****LCI LIPPERT 12" ELEC-BRAKE HUB DRUM  
- 6-STUD LANDCRUISER PCD**

## Electric Brake Backing Plate

The Electric Brake Backing Plate sits inside the hub drum and holds the shoes, magnet, actuator levers, connections and mechanical handbrake.

The backing plates magnet is attached to a lever which is connected to the shoes, when the magnet is electrified it sticks to the spinning hub drum which pulls the magnet in the same direction as the spinning hub.

As the magnet is attached to a lever that when pulled opens up the brake shoes to grip the spinning hub drum and slow down its momentum causing the trailer to brake. Another important function with the brake plate is the inclusion mechanical handbrake which is for when the trailer is parked, how it works is that is separate lever connected to the shoes & on the other end of this lever is a hole when you can connect the trailers park brake cable, when you activate your trailers hand brake this pulls on the lever which then opens the shoes providing your park brake.

### 450-11010

#### LCI LIPPERT COMPLETE 10" L/H ELEC-BRAKE ASSY

Plate. 853107



### 450-11012

#### LCI LIPPERT COMPLETE 10" R/H ELEC-BRAKE ASSY

Plate. 853108



### 450-11014

#### LCI LIPPERT COMPLETE 10" L/H ELEC-BRAKE ASSY

Plate. 853126



### 450-11016

#### LCI LIPPERT COMPLETE 12" R/H ELEC-BRAKE ASSY

Plate. 853127



### 450-03010

#### BRAKE MAGNET KIT

Electric Brake Magnet Oval Type - comes in a box complete with springs, suits DEXTER 10" x 2.25" / Hayes 10" x 2.25" & 1.625" (after 1987 up to 1993)



## ELECTRIC DRUM BRAKES

Electric drum brakes are an efficient & reliable braking system that provides smooth braking when used by a vehicle mounted with a brake controller.

### 450-03030

#### ALKO 10" X 2-1/4" RIGHT HAND ELECTRIC DRUM BRAKE

With park brake provision.



### 450-03032

#### ALKO 10" X 2-1/4" LEFT HAND ELECTRIC DRUM BRAKE

With park brake provision.



## ELECTRIC HUB DRUMS

These hub drums are machined for slimline bearings. Note when replacing magnets, it is recommended that the inside face of the hub drum be re-machined or the magnet performance will be affected.

### 450-03034

#### ALKO 10" X 2-1/4" FORD 5 STUD PATTERN ELECTRIC HUB DRUM

Machined for slimline bearings.



### 450-03036

#### ALKO 10" X 2-1/4" LANDCRUISER 6 STUD PATTERN ELECTRIC HUB DRUM

Machined for slimline bearings.



**450-03065****ALKO BOXED 10" BRAKE SHOE KIT**

Used to support and move the braking lining material, this electric brake shoe kit consists of two primary and two secondary brake shoes conveniently packaged in a box.

**BEARING KITS**

Bearings comprise of two parts, the cup which is pressed into the hub & the cone, this is the part that contains the rollers of the bearing. Bearings should always be replaced in pairs.

**450-03069****ALKO PARALLEL BEARING KIT**

A Japanese caravan bearing kit, rated to 1600kg per pair. Always ensure that only quality studs and nuts are used, which are correct for the wheel selected. Comes in a skin pack.

**450-03070****ALKO SLIMLINE/FORD CARAVAN BEARING KIT (JAPANESE)****Slimline Components Include**

1x L68110 cup, 1x LM12710 cup, 1x L68149 & 1x LM12749 cone.

**450-03072****ALKO LM/HOLDEN TRAILER BEARING KIT (JAPANESE)****LM Components Include**

1x LM67010 cup, 1x LM11910 cup, 1x LM67048 cone, 1x LM11949 cone, 1x grease cap, 1x seal & 1x split pin

**ELECTRIC DRUMS**

Brake drums are selected by the drum diameter, the wheel drilling pattern and in the case of hub drums, the machining profile and appropriate bearings. It is important to select the appropriate brake capacity and seek advice on the correct axle machining profile and bearing configuration to carry and stop the load on the wheel to which it is fitted.

**450-03084****ALKO 10" X 2-1/4" LANDCRUISER PARALLEL ELECTRICAL BRAKE DRUM****450-03086****ALKO 10" X 2-1/4" HOLDEN HT SLIMLINE ELECTRICAL BRAKE DRUM****450-03088****ALKO 10" X 2-1/4" HOLDEN HQ LM SLIMLINE ELECTRICAL BRAKE DRUM****ARK BEARING KITS****450-03100****MARINE BEARING KIT TO SUIT HOLDEN TYPE BEARINGS**

4 Piece Blister Pack

**450-03102****MARINE BEARING KIT TO SUIT FORD TYPE BEARINGS**

4 Piece Blister Pack



## SEALS &amp; BEARINGS

**450-03110****TRAILER BEARING KIT TO SUIT HOLDEN TYPE BEARINGS**

5 Piece Blister Pack

**450-03112****TRAILER BEARING KIT TO SUIT FORD TYPE BEARINGS**

5 Piece Blister Pack

**BEARING CONES****450-03128****BEARING TO SUIT HOLDEN 1-1/4" CONE**

For 39mm round or 40mm square axles.

**450-03130****BEARING TO SUIT FORD (SLIM LINE) 1-3/8" CONE**

For 45mm square axles.

**450-03132****BEARING TO SUIT HOLDEN 3/4" CONE**

For 39mm round or 40mm square trailer axles.

**450-03134****BEARING TO SUIT FORD (SLIM LINE) 7/8" CONE**

For 45mm square trailer axles.

**COAST SEALS**

Coast's range of seals are available in two grades. Standard includes a spring under the inner lip that seals against the axle. Premium heavy duty includes a firmer better-quality firmer spring providing a more durable seal in the long run.

Coast's range of bearings and seals allows for servicing of the following:

- > Holden/LM type trailer axles up to 1000kg in both standard and marine seals
- > Ford/Slimline type trailer and caravan axles up to 1450kg in both standard and marine seals
- > 1.5tonne/Composite caravan axles up to 1500kg with standard seals
- > Parallel caravan axles up to 1600kg with standard seals
- > 2 tonne and 2.5 tonne caravan axles up to 2500kg with standard seals

**450-03200****COAST HUB BEARING STD OIL SEAL - HOLDEN**

Sold by 10 pk

**450-03202****COAST HUB BEARING PREMIUM H-DUTY OIL SEAL - HOLDEN**

Sold by 10 pk

**450-03206****COAST HUB BEARING PREMIUM MARINE OIL SEAL - HOLDEN**

Sold by 10 pk

**450-03208****COAST HUB BEARING STD OIL SEAL - FORD/SLIMLINE**

Sold by 10 pk

**450-03210****COAST HUB BEARING PREMIUM H-DUTY OIL SEAL - FORD/SLIMLINE**

Sold by 10 pk

**450-03212****COAST HUB BEARING PREMIUM MARINE OIL SEAL - FORD/SLIMLINE**

Sold by 10 pk



## SEALS &amp; BEARINGS

**450-03214****COAST HUB BEARING OIL SEAL  
- 1.5 TONNE**

Sold by 10 pk

**450-03216****COAST HUB BEARING OIL SEAL  
- 2/2.5 TONNE**

Sold by 10 pk

**450-03220****COAST STD HUB REPLACEMENT GREASE  
CAP T/S HOLDEN-FORD 45.2MM DC-1**

Sold by 10 pk

**450-03222****COAST HUB REPLACEMENT GREASE CAP  
T/S PARALLEL/1.5/2/2.5  
TONNE. 63 MM DC-2**

Sold by 10 pk



## NSK JAPANESE BEARINGS

These high-quality Japanese bearings use conical rollers guided by a back-face rib on the cone and are capable of taking high radial loads and axial loads in one direction. They are ideal for use in servicing and repairing trailers and RVs.

**450-03230****NSK JAPANESE BEARING  
- HOLDEN/LM INNER****450-03232****NSK JAPANESE BEARING  
- HOLDEN/LM OUTER****450-03234****NSK JAPANESE BEARING  
- FORD/SLIMLINE INNER****450-03236****NSK JAPANESE BEARING  
- FORD/SLIMLINE OUTER****450-03238****NSK JAPANESE BEARING  
- 2 TONNE INNER****450-03240****NSK JAPANESE BEARING  
- 2 TONNE OUTER**

# LEVEL INDICATORS

**450-03504**

## TREG T BAR PIN AND LOCK

- > Locks the trailer to the vehicle or locks the trailer when un-hitched.
- > Hardened 3/4" steel pin
- > Zinc plated for corrosion protection
- > Precision Zinc alloy screw pin lock with 1/4" pin and 2 keys.



**450-04010**

## 2-WAY PLASTIC TEE BUBBLE LEVEL

Screw-mounted level, providing front to back or side to side levelling. Sold separately.



**450-03506**

## TOW BALL SPANNER

- > Tow Ball Sizes 33mm
- > Adj. Ball Mount Bolts 24mm
- > WDH Head Bolts
- > WDH Chain Bracket Bolts
- > D Shackles Pins



**450-04030**

## BULLSEYE MULTI-DIRECTIONAL LEVEL

Round, dome-shaped level reads 360° at once.



**450-03520**

## COUPLE - MATE REVERSING HITCH AID

An easy to install device which makes hitching your caravan or trailer a breeze. The side arms 'guide' the trailer hitch towards the tow ball, thus preventing damage to the tow vehicle. Made from double dipped, zinc plated steel.



**450-04032**

## CAMCO CURVED BALL LEVEL

A screw-mounted level, with graduated markings for accurate front-to-back or side-to-side levelling. Comes in a set of 2.



**450-03530**

## COUPLE-MATE TREG PIN LOCK

Featuring a latch lock with a screw lock for added security, the treg pin lock is used to lock the trailer onto your tow vehicle, or simply lock the trailer when left unattended. It has a 3/4" diameter for use with treg couplings. Note that the lock mechanism needs lubricant periodically to ensure correct operation.



**450-04006**

## SCREW ON LEVEL

Screw-mounted level provides front-to-back or side-to-side levelling. Comes in a set of 2.



## HEAVY DUTY COUPLINGS

**450-04810****HEAVY DUTY BOLT ON JOCKEY WHEEL DOUBLE CLAMP**

Heavy Duty Bolt on DOUBLE Clamp offers superior clamping force over other clamps available in the market. The Universal backing plate allows for easy fitment on 4", 5" or 6" chassis", no need for drilling or welding. Comes complete with bolts.

**450-04996****CRUISEMASTER 3500KG DO35 V3-PLUS COUPLING - INCLUDES TOW-PIN & H/ BRAKE.****FOR SAFETY ON ROAD AND CAPABILITY OFF IT**

High articulation in all direction ensures the trailer always follows you in challenging terrains. High articulation also provides safety in the event of an accident on the road.

**SIMPLE TO USE LOCKING MECHANISM**

The D035 features a simple positive locking mechanism. Once locked the Check lock cap is then fitted to keep the dirt out and to show that the coupling is securely attached.

**PATENTED DROP ON DESIGN ALLOWS EASY HITCH IN ANY TERRAIN**

This is the key to the success of the D035. Combined our patented tow pin and view port, allows easy alignment of the vehicle and trailer even in technical terrain.

**ARTICULATION:** 360 degrees axial, minimum 70 degrees other axes.

**LOCKING:** Fully ADR 62/02 compliant including automatic secondary lock

**FINISH:** Supa Alloy 5

**BOLT PATTERN:** 4 bolts at 185mm x 54mm

**RATING:** 3.5 Tonne

**ACTION:** Drop-On

**MAINTENANCE:** Fully Greasable

**NEW FEATURES:** New polyurethane bushed Tow Pin, Dustcap & Bumpstop. New Integrated Handbrake lever

**ARK XO EXTREME OFF ROAD COUPLING**

Quick-hitch off road coupling. Suits all 50mm tow balls that comply with Australian Standards AS4177.2 except 50mm tow balls with a flat flange. No more switching hitches!

**Choice of 2 ratings**

- > 2 tonne for mechanical over-ride brake systems. Part No. 450-04900
- > 3.5 tonne for electric brake systems. Part No. ORXOF50 450-04902
- > Full off road articulation
- > No more switching hitches
- > Quick-hitch locking system
- > Fits 50mm tow balls that comply with Australian Standards AS4177.2 and don't have a flat flange
- > Complies to Australian standards AS4177.3
- > Strong fully cast steel parts

Whether you are looking to improve your off road capability, or just tired of constantly having to switch between an off road hitch and a standard ball hitch, then the Ark Extreme off road Coupling is for you!

**450-04900****ARK XO EXTREME OFF ROAD COUPLING 2 TONNE****450-04902****ARK XO EXTREME OFF ROAD COUPLING 3.5 TONNE**



# SHACKLES

## SHACKLES

"The current standard applying to shackles is AS 2741-2002, however this standard does not specifically cover the use of rated shackles in an application such as attaching a trailer to a tow bar. This standard covers the use of shackles for lifting purposes.

The Caravan Industry Association of Australia's recommendation is that a shackle meeting the requirements of AS 2741-2002 be used to secure rated safety chains up to 3500kg capacity.

### Suitable shackles have the following specifications:

- > Meet the requirements of AS 2741-2002
- > Shackle grade is "S" or "6"
- > Working load limit (WLL) is 1000kg
- > Shackle diameter is 10mm
- > Either "bow" or "dee" shackle design is suitable, although it is noted that the "bow" design provides greater angular displacement

A significant detail to understand is that the breaking load of a shackle is generally six times the working load limit."

Source: RVMAP Technical Alert - D-Shackle Confusion Resolved, 20.10.2014

### 450-05000 DEE SHACKLE GALVANISED - 8MM (5/16)

Not to be used with safety chains as this is a general purpose shackle.



### 450-05002 DEE SHACKLE GALVANISED - 8MM (5/16) RATED TO 0.75T



### 450-05010 DEE SHACKLE GALVANISED - 10MM (3/8)

With a working load rating of 320kg and a proof load rating of 640kg. Not to be used with safety chains as this is a general purpose shackle.



### 450-05012 DEE SHACKLE GALVANISED - 10MM (3/8"), RATED TO 1T



### 450-05020 DEE SHACKLE GALVANISED - 12MM (3/8")

Dee Shackle Galvanised - 12mm with a working load rating of 520Kg and a proof load rating of 1040Kg. Not to be used with safety chains as this is a general purpose shackle.



### 450-05022 DEE SHACKLE GALVANISED - 11MM (7/16"), RATED TO 1.5T



### 450-05024 DEE SHACKLE GALVANISED - 13MM (1/2"), RATED TO 2T



## HAND BRAKE SPARES

### 450-05050 HAND BRAKE WIRE CABLE 4mm x 10m length



### 450-05060 HAND BRAKE CABLE ADJUSTER (With Pulley)



### 450-05070 HAND BRAKE CABLE CLIPS



### 450-05080 BRAKE CABLE PULLEY



## CORNER STEADIES

## ALKO COUPLINGS

**450-05110**  
**2000KG 2-HOLE SNAP ON COUPLING WITH BALL ADJUSTER**

Mounting Hole: 101.6L x 13.5W (mm) zinc plated surface, ball to first centre.  
Hole: 77mm

**450-05120**  
**3500KG ELECTRIC COUPLING WITH HAND BRAKE**

A zinc plated coupling that is simple to attach to the tow ball.

**Specifications**

Mounting Hole: 182.5L x 55W (mm)  
Diameter: 13.5mm

**450-05130**  
**2000KG MECHANICAL OVERRIDE COUPLING (NO PLATE)**

A zinc plated coupling that is suited to 50mm ball types.

**Specifications**

Mounting Hole: 184L x 54W x 13.5 Diameter (mm)  
Ball to first centre hole: 137mm

**450-05140**  
**BRAKE PLATE FOR MECHANICAL OVERRIDE COUPLING**

Has a painted surface.

**Specifications**

Mounting Hole: 184L x 54W x 13.5 Diameter (mm)

**450-05146**  
**ALKO AKS TOW BALL RETENTION PLATE**

AKS anti-rotation 50mm tow ball plate for lug type tow bar 75mm wide.

**450-05147****ALKO AKS HIGH RISE 50MM TOW BALL**

AKS anti-rotation 50mm high rise tow ball (black)

**450-05150**  
**HYDRAULIC CONVERSION WITH 3/4" MASTER CYLINDER**

Converts mechanical couplings to hydraulic couplings (a more reliable braking system), suited for vehicles with a hydraulic drum/brake set up, zinc plated.



## ALKO CORNER STEADIES

Corner steadies are not designed to be used as a jack or as the method of lifting the trailer off the ground. They are designed to stabilize the trailer or caravan when stationary.

**450-05300**  
**500MM CORNER STEADY**

Has a front hex drive & is zinc plated.

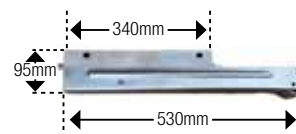
**450-05302**  
**500MM CORNER HEX DRIVE**

(Bolt On)

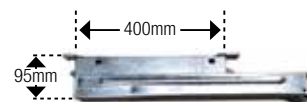
**450-05310**  
**600MM CORNER STEADY**

Has a front hex drive & is zinc plated.

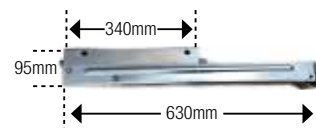
**450-05320**  
**700MM CORNER STEADY**

Has a front hex drive & is zinc plated.

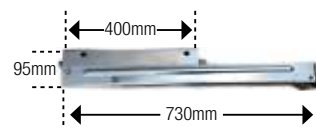
**450-05322**  
**700MM CORNER HEX DRIVE**

(Bolt On)

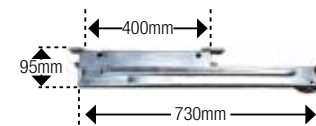

## SHACKLE PINS &amp; NUTS

**450-05350****500MM CORNER STEADY**

With wheel, has a front hex drive & is zinc plated.

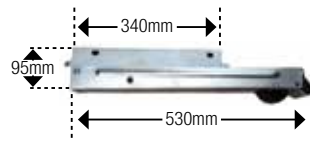
**450-05360****600MM CORNER STEADY**

With wheel, has a front hex drive & is zinc plated.

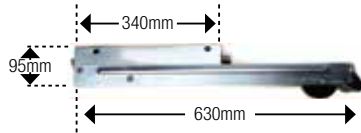
**450-05410****ALKO CORNER STEADY 510MM**

Has a hex drive, comes complete with a bigfoot making it ideal for softer ground and is zinc plated. (370mm closed)

**450-05400****590MM DROP DOWN CORNER STEADY****450-05402****ALKO BLACK 590MM DROP DOWN CORNER STEADY****450-05450****740MM DROP DOWN CORNER STEADY****450-05452****ALKO BLACK 740MM DROP DOWN CORNER STEADY****450-05460****REPLACEMENT HANDLE TO SUIT ALKO CORNER STEADIES**

## NYLON BUSHES FOR SPRINGS

**450-05500****ALKO SPRING NYLON BUSH - 1/2" X 7/8" X 45MM****450-05510****ALKO SPRING NYLON BUSH - 9/16" X 7/8" X 45MM****450-05530****ALKO SPRING NYLON BUSH - 9/16" X 3/4" X 45MM****450-05540****ALKO SPRING NYLON BUSH - 5/8" X 7/6" X 60MM**

## SHACKLE PINS &amp; NUTS

**450-05630****ALKO SHACKLE PIN - 9/16" X 3-1/2"**

Comes with Nyloc Nut (Non Grease-able)

**450-05640****ALKO SHACKLE PIN - 9/16" X 3-1/2"**

Long (Grease-able)

**450-05660****ALKO SHACKLE PIN - 5/8" X 3-1/4"**

Long (Non Grease-able)

**450-05730****ALKO SHACKLE PIN NYLOC NUT 5/8" UNF**

(Unified National Fine is a thread form with a 60 degree flank angle rounded roots and flat crests)



## TOW BALL WEIGHT SCALE

**450-05740****ALKO SHACKLE PIN NYLOC NUT 9/16" UNF**

(Unified National Fine is a thread form with a 60 degree flank angle rounded roots and flat crests)

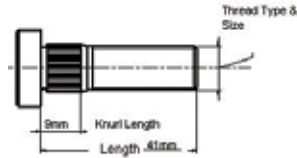
**450-05800****ALKO WHEEL STUD KNURLED 1/2" UNF X 41MM****450-05850****ALKO WHEEL NUT 1/2" UNF**

(Nut Angle 60 Degrees) - 20.5mm diameter

**TOWSAFE TOW BALL WEIGHT SCALES****450-05990****TOWSAFE TOW BALL WEIGHT SCALE**

Avoid unnecessary fines or even worse accidents by knowing your tow ball weight before you head out on a trip. Why do you need to know your tow ball weight? To put it simply, it is unsafe. Too much weight on your tow ball can cause excessive trailer sway, diminished handling and decreased braking ability. Not to mention it can be costly. The laws vary between states but on-the-spot fines can be issued if you exceed your RVs and your vehicles' tow ball weights. The TowSafe Scale is compact and easy to store. It is made from heavy-duty metal but is gentle on your RV's coupling thanks to a soft rubber head. The gauge is easy to read and will handle up to 350kg. It has also been tested to Australian Standards (AS/NZS ISO10012:2004) so you know you're getting a quality product.

**REICH CARAVAN WEIGHT CONTROLS**

Caravan Weight Control provides you with complete control over the total weight and the partial loads on the individual wheels. The handy scale will help you prevent overloading as well as loading unevenly which will negatively affect driving behavior. Caravan Weight Control works reliably and precisely and is suitable for cars, delivery vehicles, motorhomes, caravans and trailers.

**Three measuring programs for:**

1. Caravan with one axle and support wheel
2. Caravan with tandem axle and support wheel
3. Motorhome

**450-05910****REICH CARAVAN WEIGHT CONTROL YELLOW 1000KG****Specifications**

Max. load per wheel: 1,000 kg (yellow)

Deviation: < 3 %

Temperature range: 0 to 50°C

Batteries: 3 x 1.5 V Alkaline Type AAA

Dimensions: 360 x 70 x 45 mm

**450-05912****REICH CARAVAN WEIGHT CONTROL ORANGE 1500KG****Specifications**

Max. load per wheel: 1,500 kg (orange)

Deviation: < 3 %

Temperature range: 0 to 50°C

Batteries: 3 x 1.5 V Alkaline Type AAA

Dimensions: 360 x 70 x 45 mm



## PURPLELINE

## PURPLELINE



A leading supplier to the RV market, offering a comprehensive range of remote caravan movers and one of the largest and most varied caravan security and safety product ranges in Australia. As a design-led company, Purple Line specialises in manufacturing innovative and affordable product solutions based on the needs of the market.

**450-06002****KOJACK 4T JACK KIT (NEW)  
HIGHER EXTENSION**

The ideal caravan jack that is able to lift a huge 4tons almost effortlessly. Its 3-piece jack handle ensures a smooth hydraulic action. The Kojack mounts under the caravan chassis, so there's no need to dismantle jockey wheels, and its compatible with both ball and block fittings to match most Australian caravans such as Goldstream, Elite and Jayco. Each kit includes: x1 4ton hydraulic Kojack, x1 ball fitting, x1 block fitting, x1 100mm extension, x1 Allen key, x1 3-piece jack handle, x1 fitted carry case and attachment collars.

**Specifications**

**Weight:** 12kg

**Lift Range:** 220mm (more if extension pieces are used)

**450-06010****KOJACK BASEPLATE**

Kojack® Baseplate adds stability: If you have a Purple Line® Kojack® 4 tonne caravan jack and want to make it even more stable and secure, the new Kojack® Baseplate is the answer. Ideal for soft ground, gravel or sand, Baseplate gives you a footprint three times the size of the Kojack® itself, which means three times the stability and a third of the downward pressure. It clips onto the Kojack® easily and securely and can also double as a secure footing for your jockey wheel.

**Features**

- > Can be used under jockey wheels to keep them in place and stop them from sinking
- > Spring loaded latch keeps the jack in place
- > Solid metal construction
- > The ideal upgrade for kojack jack
- > Suitable for most terrain including: sand, mud, grass, bitumen and gravel
- > Australian designed and developed
- > 2 Year warranty



**450-06032****PURPLELINE TORPEDO HITCH PIN LOCK**

Add extra security to your vehicle

- > Towing rating 3500kg
- > Resistant to cutting, drilling & gas freezing
- > Suits class 4 receiver up to 75mm
- > Compliant with Australian Standards: 4177.1-2004

**450-06040****SOCKET EXTENSION**

An extender socket great for use on corner steady legs and the Kojack Leveller (to stabilise, raise or lower an RV). It can also be used to tighten or loosen other bolts and nuts provided they are 19mm in size. Made from high tensile steel and designed for use with a torque sensitive rechargeable drill.

**450-06050****SOCKET EXTENSION WITH UNIVERSAL JOINT**

Similar to the Socket Extension (above) except that it has a universal joint to facilitate tight spots. It can also be used to tighten or loosen bolts and nuts of 19mm, and is also made from high tensile steel.

**450-06064****NEMESIS WHEEL CLAMP**

The Nemesis wheel lock is made from specially hardened high tensile steel which is resistant to cutting and drilling and incorporates an exclusive high security 9-lever barrel lock, resistant to picking, drilling and gas freezing. The lock is made by Lowe and Fletcher (UK). It is supplied with a handy carry bag to store the unit when not in use. Built with composite metals, resistant to cutting, drilling and gas freezing. Incorporating a seven-pin anti-pick and anti-drill locking bolt with a tubular anti-copy key. Strong, secure and tough, it remains quick and easy to fit.



Suitable for steel and alloy wheels. New Model, 'one size fits all' - suitable for on and off road wheels up 17" and tyres up to 275mm cross-section. Now comes with three keys. The Nemesis wheel lock is the perfect highly visible deterrent.

**Ideal for**

- > Cars
- > Large Off-Road Tyres
- > Some light commercial vehicles (check wheel/Tyre combinations)
- > Motorhomes
- > Caravans
- > Camper Trailers
- > Boat trailers
- > Horse floats
- > General trailers
- > The Purpleline Nemesis comes with a 2 year warranty.

**450-06059****KOJACK 150MM EXTENSION PIECE****450-06072****PURPLELINE ANTI THEFT PACK**

Complete Security Kit keeps you safe: Purple Line® has made it a whole lot easier to guard your caravan against thieves with its new Complete Security Kit, which combines the tough Samurai wheel clamp and Saracen® hitch lock in one compact, easy-to-use kit. Keyed alike for maximum convenience, both units have Purple Line's tough, 7-pin locking mechanism, as also used in the big Nemesis® wheel clamp and the hitched-and-unhitched Saracen® Ultra hitch lock. All in a convenient carry bag and backed by a 2 year warranty.

**Features****Samurai Wheel Clamp**

- > Simple to use, compact and quick fit
- > Fits tyre widths 145 to 275mm
- > Suitable for both on and off road wheels
- > 2 Year warranty

**Saracen Hitch Lock**

- > High security hitch lock
- > Quick and easy to fit
- > Resistant to cutting, picking, drilling and gas freezing
- > Made from high strength composite materials
- > 2 Year warranty

**450-06082****SARACEN AUSTRALIAN HITCH LOCK**

Made from especially hardened, high tensile steel, the Saracen is a high security hitch lock that is resistant to cutting and drilling. It is a quick and easy to fit solution to prevent your RV from being towed away. Featuring a Lowe and Fletcher lock, which is also resistant to picking and freezing, the Saracen comes with two keys and is suitable for use on most Australian caravan coupling hitches. Comes with a one year manufacturer's warranty.



Compatible with the following hitches: Alko, Trigg Boss, Meher, Trojan and some other standard Australian hitches.

## PURPLELINE

**450-06085****GULLWING EURO HITCH LOCK**

Designed to fit Alko stabilizer hitches AKS2004 and AKS3004, found predominantly on European RVs such as Bailey, Swift and Adria. It is highly secure, easy to fit and takes a couple of minutes to install. The Gullwing can be fitted to a van whether it is hitched or not.

**450-06086****SARACEN ULTRA HITCH LOCK**

The Saracen Ultra hitch lock suits Australian standard 50mm ball hitches and fits both when HITCHED and UNHITCHED.



Saracen Ultra suits any trailer with a standard 50mm ball hitch - boat and work trailers, caravans and camper trailers, horse floats, box trailers, car and motorcycle trailers - any trailer at all.

**Features**

- > Made from specially hardened high strength steel
- > Resistant to cutting and drilling
- > Incorporates a high-security, 7-pin barrel lock, resistant to picking, drilling and gas freezing.
- > Suits Australian standard 50mm ball hitches
- > Fits both when HITCHED and UNHITCHED.

**450-06088****SARACEN OFF ROAD HITCH LOCK**

Today's tough Aussie off-road vans are increasingly fitted with the Vehicle Components Hitchmaster® D035 articulated hitch, and now Purple Line® has developed a tough new hitch lock to protect it. The new Saracen® Off-Road hitch lock provides the same combination of toughness and easy fitting for the D035 as the standard Saracen® models do for standard 50mm ball hitches. As with all Purple Line® anti-theft products, it features tough metal construction, engineered to give maximum protection for Aussie caravanners. It comes with Purple Line's tough, 7-pin locking mechanism, and is fitted simply by placing the backing plate in position, clamping over the cover and locking the stout locking pin. Backed by a 2 year warranty, it is as tough as the tough Aussie vans it protects - and it makes life even tougher for would-be thieves.

**It has all the proven Saracen features including**

- > High strength steel construction
- > Anti-pick seven-pin cylinder lock
- > Anti-copy tubular key
- > Suits V1, V2 & V3 D035

**450-06090****AEROPLUS CARAVAN WIND DEFLECTOR**

Proven to reduce drag, the AeroPlus improves towing stability by directing airflow over your RV. This in turn, helps to minimize wear and tear to your tow vehicle whether it be mechanical or your tyres. It is made from ABS plastic and fits most 4WDs, SUVs and station wagons.

The AeroPlus is easily fitted onto an existing horizontal roof rail by means of two clamps which are tightened by hand. As you drive, it directs the air over the top of your RV and thus reduces drag and improves fuel economy. It is suitable for use on most roof rails such as Rola, Rhino and Thule (providing that the rail is not wider than 80mm). Comes with angled spacers to increase the angle of the AeroPlus and a two year manufacturer's warranty.

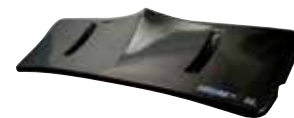
**Specifications**

**Weight:** 7kg (including packaging and fittings)

3.5kg (ABS plastic tail only)

**Dimensions:** 135W x 20H (cm)

Note: The AeroPlus has been wind tunnel tested up to a speed of 60mph (96kmph). It is therefore advised that if travelling whilst the AeroPlus is fitted, 96kmph is not exceeded. Drivers should always adhere to the road rules of the state they are travelling in.

**450-06082****SARACEN AUSTRALIAN HITCH LOCK V2**

The new and improved Saracen V2 features a unique tow chain lock feature allowing the user to lock their tow chains & hitch together. To further aid security, Saracen V2 also features additional hardened steel collars around the edges of the pin lock.



Made from especially hardened, high tensile steel, the Saracen is a high security hitch lock that is resistant to cutting and drilling. It is a quick and easy to fit solution to prevent your RV from being towed away. Featuring a Lowe and Fletcher lock, which is also resistant to picking and freezing, the Saracen comes with two keys and is suitable for use on most Australian caravan coupling hitches.

**Specifications**

Compatible with the following hitches: Alko, Trigg Boss, Meher, Trojan and some other standard Australian hitches.

Comes with a one year manufacturer's warranty.

## MILENCO RAMPS

**450-06400**  
**MILENCO INTERNAL**  
**UNIVERSAL SILVER**  
**THERMAL CAB BLIND**

This one-size-fits-all blind features high quality, black sucker pads with their own handles to stop any distracting light through for you to get a good night sleep! For optimum performance in winter conditions, warm up demister before removing.

**450-08002**  
**MILENCO QUATTRO LEVEL**  
**PAIR**  
**(160MM MAX LIFT)**

Sold in pairs complete with carry case.

Europe's best-selling large Level lifts to 160mm and incorporates a lattice, high-grip upper tread surface. It pockets the wheel at every height and features a solid base to stop sinking on soft terrain. The high grip leading edge prevents slippage when approaching and avoids the need for gripper plates.

**Specifications**

Dimensions: 20cm H x 24.5cm W x 81cm L

Height of Each Step: 4cm/8cm/12cm/18cm

Weight: 3.8kg Per Level

Capacity: 1500kg Per Wheel = 6000kg Motorhome or 3000kg Caravan

**450-08006**  
**MILENCO MGI WEDGE**  
**LEVELS**  
**(TWIN PACK)**

A conventional wedge-shaped Level with 50% Base and 50% Top surface area featuring a lightweight, strong construction. The high grip leading edge removes the need for gripper plates. Compatible with MGI Milenco Wedge Level Chock.

**Specifications**

Dimensions (approx): 11cm H x 18cm W x 46cm L

Height of Each Step: 4cm/8cm/12cm/18cm

Weight: 1kg Per Level

Capacity: 1000kg Per Wheel = 4000kg Motorhome or 2000kg Caravan

**450-08008**  
**MILENCO MGI WEDGE LEVEL**  
**CHOCK**

An extra wide chock with side handles to reduce the risk of hand trap. Compatible with MGI Milenco Wedge Levels. Available singularly.

**450-08010**  
**MILENCO MGI WEDGE**  
**LEVEL WITH CHOCK**

A pack consisting of 1x MGI Wedge Level (450-08006) and 1x MGI Chock (450-08008).

**450-08020**  
**MILENCO STACKA TYRE**  
**SAVER**  
**(TWIN PACK)**

These heavy duty tyre savers feature a durable design and a solid base to prevent sinking on soft terrain. Suitable for twin axle, single axle, and tag axle.

**Specifications**

Capacity: 1500kg Per Wheel = 6000kg Motorhome or 3000kg Caravan

**450-08022**  
**MILENCO GIANT LATTICE**  
**TREAD GRIP MAT (TWIN**  
**PACK)**

This heavy-duty, extra large set of Grip Mats is designed to provide excellent performance in wet conditions. The Lattice design allows them to be linked together without being tied.

**Specifications**

Dimensions Per Mat: 106cm L x 33cm W



## STONE SHIELDS

## STONE SHIELDS



Protect your RV, and prolong the life of its paintwork, by installing a Stone Shield. Supplied as a flat pack, it is quick and easy to install onto the A-frame of your caravan or camper trailer. Made from tough rip stop mesh (resistant to rips or tears), the Stone Shield stops stones (and other hard debris) from chipping, or potentially even denting your RVs paintwork. Comes with two extra-large rubber mud flaps to protect the undercarriage of your caravan or camper trailer.

**450-06500**  
**CARAVAN STONE SHIELD**
**Specifications**

Dimensions: 2310mm x 500mm

Net Weight: 16.0kg

**450-06520**  
**CAMPER TRAILER STONE SHIELD**
**Specifications**

Dimensions: 1800mm x 500mm

Net Weight: 14.8kg

**450-06510**  
**CAMPER VAN STONE SHIELD**
**Specifications**

Dimensions: 2150mm x 500mm

Net Weight: 15.7kg



## STONE SHIELDS

450-06613

STONE SHIELD RUBBER  
MUD FLAPS X2 #9 T/S  
TRAILER

500-99994

RETRO REFLECTOR



450-06608

STONE SHIELD RUBBER  
MUD FLAPS X2 #9 T/S  
BOTH CARAVAN & CAMPER

450-06614

STONE SHIELD RIP STOP  
MESH #10 T/S TRAILER

450-06611

STONE SHIELD RIP STOP  
MESH #10 T/S CAMPER

450-06609

STONE SHIELD RIP STOP MESH  
#10 T/S CARAVAN





# SECTION 4

## ELECTRICAL EQUIPMENT

(Product Group - 500)

Fans and Smoke Alarms	156
Battery & Accessories	157 - 159
Narva Electrical Fittings	171 - 175
Power Inlets and Outlets	175 - 177, 181 - 182
Power Points & Switches	176 - 182
Electrical Leads	179 - 180
CMS Equipment	180 - 182
15amp-10amp Adaptors	182 - 183
NARVA Accessory Sockets	183 - 184
Solar Panels	185 - 186
Tyre Inflators (Air Compressors)	186 - 187
Trailer Plugs and Sockets	187 - 189
Cable Ties	189
Caframo Fans	190 - 191
Briggs and Stratton Generators	192

## LIGHTING EQUIPMENT

(Product Group - 500)

Lights and Lenses	160 - 162
Truck and Trailer Lighting	163 - 165
Led Bulbs	166 - 167
Reflectors	168
Sphere™ Wireless Lighting	169 - 170

## GAS EQUIPMENT

(Product Group - 550)

Gas Regulators and Hoses	193 - 196
Gas Unions, Nuts and Valves	195 - 198
Gas Cylinders and Cradles	198
Gas Detector	198

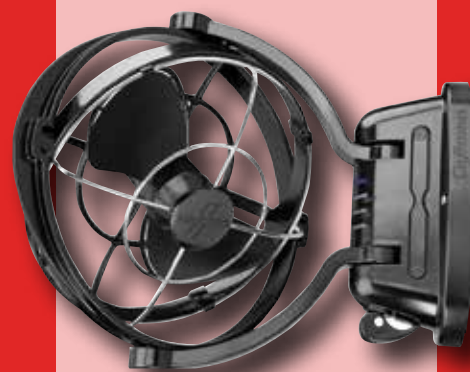

**500-00082****FAN AND LIGHT COMBO (WHITE)**

Suitable for use in Jayco Campers and Expandas, this reading light has a 2-speed fan. It has a 1/4" (6.4mm) jack which allows it to fit into an existing 12V internal light (such as 500-05004, 500-05005, 500-05006 and 500-05007). There are also two plastic U-brackets on the rear/top that will clip onto a 3/4" - 1" (19.1mm - 25.4mm) camper support pole. Alternatively, it can be hung using the single U-bracket at the back to hang it vertically. Made in the USA to Australian and NZ standards, it also features a curly cord that extends up to 8ft (2.4m) and comes with a globe\*.



\* You can replace this globe with a Coast LED, either 500-05758 or 500-05760 will fit.

**Specifications**

**Power:** 12VDC, 1.3A (max)

**Dimensions:** 250L x 145W (mm)

**500-00200****SAFETY HUSH SMOKE ALARM**

Ideal for fast flaming fires, the Hush Smoke Alarm is easy to install with no wiring necessary. It has a feature that enables the alarm to be switched off for 10 minutes in case of false alarms. It also has an ionisation sensing chamber which automatically resets once the smoke is cleared. This smoke alarm comes with a 9V battery which lasts approximately nine months. A warning signal will sound when the battery is running low.

**500-00730****SETEC DRIFTER**

The Setec Drifter is an LCD display unit with the capacity to monitor up to four water tanks and a 12V battery. This means that you'll know when you're running low on fresh water or when your waste tank needs to be emptied (if you choose this as an option to monitor), all whilst observing your battery's status (current going in and out). It is compatible with any 12V lead acid battery, including VRLA, AGM, Gel and even the traditional non-sealed batteries.

**Specifications**

**DC Power Input:** 8-15V DC, 0.7-0.35A

**USB Output:** 5V DC at 0.9A C-Tick Approved

**Complies with IEC 61010-1, ED: 2001, CISPR 11:2009**

**Dimensions:** 149L x 85H x 22W (mm)

**Weight:** 0.21kg

**500-00749****SETEC DRIFTER WATER SENSOR TANK SET**

The Setec Drifter, part number 500-00730 (above) comes with wiring for up to two tanks. You could choose to utilize this to monitor two water tanks or, one water tank and one waste tank. Should you want to monitor extra tanks, a Water Sensor Tank Set must be purchased (one set per tank).

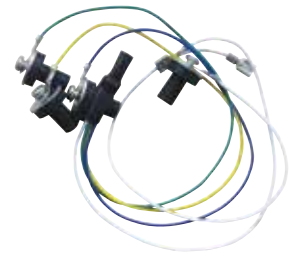
**500-00220****QUELL PDO4 CARBON MONOXIDE DIGITAL DISPLAY ALARM**

Protect your family and safeguard your RV by adding a Carbon Monoxide alarm, these units are cost effective and easy to install. What is Carbon Monoxide? Carbon monoxide (CO) is a highly poisonous gas with no taste, colour or smell.



Carbon monoxide (CO) alarms detect the early presence of carbon monoxide emitted from gas sources such as heating and cooking systems, vehicle engines, fuels and blocked chimneys. CO alarms are intended to supplement conventional smoke alarms, not replace them. A CO alarm is not a smoke alarm and, therefore, will not satisfy legal requirements regarding the installation of smoke alarms in the home.

**Features**

- > Peak level memory Displays the highest CO concentrate measured since the last reset
- > Self-activation Alarm automatically activates when attached to the mounting bracket
- > Test/Reset button Tests the alarm circuitry and horn. Resets memory after the alarm has sounded
- > LED indicators Flashing green LED every 30 seconds indicates the unit is operating properly. Pulsing red LED with alarm indicates a dangerous level of carbon monoxide has been detected. Amber LED indicates the unit is in fault mode
- > Deactivation switch Disables the alarm to allow for safe battery disposal once the unit has reached the end of its 10-year life
- > 10-year limited warranty Provides peace-of-mind with a decade of carbon monoxide detection
- > 3 x AA batteries included

**Specifications**

**Dimensions:** 120mm x 75mm x 40mm

# BATTERIES & ACCESSORIES

## SPHERE BATTERIES

Sphere 12V Valve Regulated AGM Rechargeable Batteries are available in two models to suit most needs. Ideal for use in caravanning and camping, the AGM design offers improved discharge and recharge efficiencies. They require less maintenance, are spill proof and are safer for you and the environment compared to conventional alternatives.

### 500-00820

#### SPHERE 12V 100AH VALVE REGULATED AGM RECHARGEABLE BATTERY



##### Specifications

**Internal resistance:** Fully Charged at 25°C: 4.9 Ohm

**Max. Discharge Current:** 1200A(5s)

##### Operating Temperature

**Discharge:** -15 ~50°C

**Charge:** 0 ~40°C

**Storage:** -15 ~40°C

##### Charge Method (25°C)

**Max. Charge current:** 40

**Cycle use:** 14.4-15.0v(-30mv/ °c)

**Float use:** 13.5-13.8v(-20mv/ °c)

**Self Discharge:** 3% of capacity declined per month at 20°C

**Dimensions:** 307L x 168W x 214H (mm)

### 500-00822

#### SPHERE 12V 120AH VALVE REGULATED AGM RECHARGEABLE BATTERY



##### Specifications

**Internal resistance:** Fully Charged at 25°C: 4.9 Ohm

**Max. Discharge Current:** 1200A(5s)

##### Operating Temperature

**Discharge:** -15 ~50°C

**Charge:** 0 ~40°C

**Storage:** -15 ~40°C

##### Charge Method (25°C)

**Max. Charge current:** 40

**Cycle use:** 14.4-15.0v(-30mv/ °c)

**Float use:** 13.5-13.8v(-20mv/ °c)

**Self Discharge:** 3% of capacity declined per month at 20°C

**Dimensions:** 330L x 171W x 219H (mm)

## SPHERE LITHIUM BATTERIES

Sphere lithium batteries are the future of mobile power storage. Lithium batteries are much lighter than traditional lead acid and AGM batteries and deliver unrivalled cycle life, more than four times more cycles compared to lead acid and AGM batteries.

Perfect for use in caravans, marine, camping and home storage applications, Sphere Lithium batteries are fully sealed and feature a built-in battery management system for safety.

If you are replacing an existing deep cycle lead acid or AGM battery you can continue to use your same battery charging system and the built-in battery management system will do the rest for you. You will also notice that lithium batteries charge more efficiently than lead acid and AGM batteries so the recovery will be much quicker.

Sphere lithium batteries use active cell balancing technology to balance the internal battery cells not only whilst charging but also whilst discharging. This assist's in getting the battery as close to 100% charge levels as possible.

- > 100AH AND 120AHLithium Ion
- > 2000+Cycles
- > Built in advanced BMS with Dynamic cell balancing
- > Lightweight
- > 3 Year Warranty
- > Can be connected in series or parallel. Maximum in series voltage of 30.4V

*Note: These batteries can't be used to start motor vehicles*

### 500-00830

#### SPHERE 12V 100AH LITHIUM RECHARGEABLE BATTERY



##### Specifications

**Dimensions:** 334 x 175 x 219mm

**Weight:** 13.74kgs

**Operating Temperature Range:** -20°C ~ +60°C

**Voltage:** 12.8VDC

**Amperage:** 100A

**Nominal Charge Rate:** 30A

**Max Charge Current:** 100A

**Max Charge Voltage:** 14.8V

**Recommended Charge Rate:** 30A

**Maximum In-series voltage:** 30.4V

### 500-00832

#### SPHERE 12V 120AH LITHIUM RECHARGEABLE BATTERY



##### Specifications

**Dimensions:** 334 x 175 x 219mm

**Weight:** 15.0kgs

**Operating Temperature Range:** -20°C ~ +60°C

**Voltage:** 12.8VDC

**Amperage:** 120A

**Nominal Charge Rate:** 30A

**Max Charge Current:** 100A

**Max Charge Voltage:** 14.8V

**Recommended Charge Rate:** 30A

**Maximum In-series voltage:** 30.4V

## BATTERIES &amp; ACCESSORIES

**500-00834**  
**SPHERE 12V 200AH LITHIUM**  
**RECHARGEABLE BATTERY**
**Specifications**

Dimensions: 365x185x245mm  
 Weight: 19.7kg  
 Operating Temperature Range: -20°C ~ +60°C  
 Voltage: 12.8VDC  
 Amperage: 200A  
 Nominal Charge Rate: 30A  
 Max Charge Current: 100A  
 Max Charge Voltage: 14.8V  
 Recommended Charge Rate: 30A  
 Maximum In-series voltage: 30.4V

**500-02036**  
**CAMCO REPLACEMENT**  
**BATTERY BOX STRAP &**  
**HARDWARE**

Camco's Replacement Strap for Battery Box measures 990mm long x 38mm wide. It is made of woven polypropylene and includes the hardware to attach it to the battery box.



- > 990mm long x 38mm wide
- > Includes hardware to attach to battery box
- > Made of woven polypropylene
- > Heavy-duty and durable
- > Easy to install

**CAMCO BATTERY BOX**
**500-02012**  
**BATTERY BOX**  
**- LARGE. C/W LID**  
**+ STRAP**  
**328L X 188D X 195H**

**500-02038**  
**CAMCO STANDARD**  
**BATTERY TRAY**  
**- PLASTIC**

It is heavy-duty acid-resistant plastic with stainless steel hardware



- > Heavy-duty acid-resistant plastic
- > Stainless steel hardware

**500-02032**  
**CAMCO BATTERY BOX - SMALL**

Camco RV Standard Battery Box is a black, lightweight, heavy-duty corrosion-resistant polypropylene box which is designed to secure and protect batteries. It includes a lift-off lid, durable woven hold-down strap, foot clamps and stainless steel screws.

**500-02040**  
**CAMCO LARGE BATTERY**  
**TRAY - PLASTIC**

It is heavy-duty acid-resistant plastic with stainless steel hardware.



- > Heavy-duty acid-resistant plastic
- > Stainless steel hardware

- > Includes lift-off lid, durable woven hold-down strap, foot clamps and stainless steel screws
- > Lightweight, heavy-duty corrosion-resistant polypropylene box
- > It has internal dimensions of 273L x 184D x 200H (mm) with 50mm additional head room for battery terminals.

**500-02034**  
**CAMCO BATTERY BOX - LARGE**

Camco RV Large Battery Box is a black, lightweight, heavy-duty corrosion-resistant polypropylene box which is designed to secure and protect batteries. It includes a lift-off lid, durable woven hold-down strap, foot clamps and stainless steel screws.



- > Includes lift-off lid, durable woven hold-down strap, foot clamps and stainless steel screws
- > Lightweight, heavy-duty corrosion-resistant polypropylene box
- > It has internal dimensions of 336L x 184D x 219H (mm) with 50mm additional head room for battery terminals.



# BATTERIES & ACCESSORIES

## ANBI SWITCH BATTERY ISOLATOR

The ANBI Battery Switch eliminates drainage of stored power by isolating the battery from power-hungry components like clocks, and general energy leakage. Installation is quick and easy and can be completed in less than 15 minutes.

Even when your ignition key is off, there are still components that draw current and continue to drain your battery. That's why it's common to find it flat when you go to start a vehicle, like a caravan, classic car, or ride-on mower after it's sitting for an extended period of time. This is both inconvenient and costly as a completely flat dead battery can often become damaged if left uncharged for an extended period.

ANBI also provides a theft deterrent by virtually immobilising the vehicle when activated. This can result in significant savings on insurance premiums. Make sure your steed is ready to go when you are, install an ANBI Battery Switch today!

### 500-02120

#### ANBI SWITCH - BATTERY ISOLATOR

The ANBI Switch is a simple, high quality, robust solution to help you avoid flat batteries.

- > 5 Year Warranty
- > Simple installation
- > Suitable for wide range of applications
- > Proven anti-corrosive. Exceeds international standards for salt and sea spray.
- > Accelerated life tested for proven durability
- > Designed and manufactured in Australia



### 500-02121

#### ANBI SWITCH CARAVAN & CAMPERTRAILER - BATTERY ISOLATOR

Nothing's more frustrating than going to hitch-up your caravan or camper only to discover that you've fallen foul of a flat battery! Now you can avoid disappointment and inconvenience, with an inexpensive and simple to install ANBI Battery Switch. The ANBI Battery Switch eliminates drainage of stored power, by isolating the battery from energy leakage. Installation is quick and easy and can be completed in less than 15mins. Make sure you're always ready to go and install an ANBI Battery Switch today!



#### Specifications

Vibration tested to Australian Standard  
 1200A at 12V for 5ms  
 600A at 24V for 5ms  
 120A at 12V continuous load max  
 60A at 24V continuous load max

### 500-02124

#### ANBI SWITCH - EXTENSION KIT

Allows the user to fit the ANBI Switch more remotely, out of sight if needed or to avoid a tight space.



## EXTERNAL LIGHTING

**500-01014**  
**BARGMAN LIGHT**  
**REPLACEMENT LENS ONLY**



**500-01030**  
**HALOGEN PORCH LIGHT**  
**WITH SWITCH**

Porch light c/w switch white base - clear lens 12V



**500-01033**  
**LENS ONLY TO SUIT**  
**CURRENT PORCH LIGHT**  
**(CLEAR)**



**500-01036**  
**LED ANNEX LIGHT**

Has a white base that mounts onto your RV wall (comes with screws for installation). Also has a clear lens. Note: This is an interior LED light. It can be used on the exterior provided it is sealed.



**500-01038**  
**ANNEX LIGHT WITH**  
**SWITCH - BLACK**



**500-01050**  
**COAST LIGHT WITH GRAB**  
**HANDLE**

Comes in white to compliment your RV's exterior. Made from UV stabilised plastic, it is lightweight & is supplied with a 10W globe.



**500-01051**  
**LENS FOR COAST LIGHT**  
**WITH GRAB HANDLE**



**500-01055**  
**REPLACEMENT**  
**SWITCH, LOCKING**  
**RING + BUTTON**  
**COVER T/S**  
**XC9HANDLE03/**  
**C4323B. C4235**



**500-01057**  
**GRAB HANDLE**  
**WITH LED**

Featuring a simple and modern design, the latest Coast Grab Handle sheds light around your RV entry area. Turn it on or off (as required) using the trigger switch found on the underside of the handle. Comes with a five year manufacturer's warranty.



**Specifications**

**Dimensions:** 175H x 149W x 50D (mm)

**Voltage:** 10 - 36V

**Material:** Polycarbonate

**500-01059**  
**GRAB HANDLE WITH LIGHT**  
**- BLACK**



## LIGHTING

## COAST LED ASSIST HANDLES

Available in 3 colours - Black, White and Chrome, Coast to Coast LED Assist Handles offer practical convenience, stylish modern design and the following great features:

- > LED mode touch switch conveniently located behind the handle
- > IP65 water resistance, built for outdoor use
- > Natural white LED illumination
- > Blue LED courtesy light

**Specifications**

Voltage: 12V

White Power Draw: 2W

Blue Power Draw: 0.8W

Light Operation: White - Blue - Off

IP Rating: IP65

Carton Quantity: 23

**500-01062**  
**ASSIST HANDLE W/ 12V LED LIGHT**  
**BLACK ABS**



**500-01064**  
**ASSIST HANDLE W/ 12V LED LIGHT**  
**WHITE ABS**



**500-01066**  
**ASSIST HANDLE W/ 12V LED LIGHT**  
**CHROME ABS**



## TEARDROP LED ASSIST HANDLE

Great for lighting up your awning area, the Coast LED Awning Lights are

**Features**

- > Stylish and functional design
- > LED mode touch switch
- > IP67 water resistance, built for outdoor use
- > Daylight white LED illumination

**Specifications**

Voltage: 12V

White Power Draw: 2W

Light: Daylight White (6,000K)

IP Rating: IP67

**500-01072**  
**COAST TEARDROP LED ASSIST**  
**HANDLE W/ 12V LIGHT - IP67**  
**- WHITE**



**500-01074**  
**COAST TEARDROP LED ASSIST**  
**HANDLE W/ 12V LIGHT - IP67**  
**- BLACK**



## COAST LED AWNING LIGHTS

Great for lighting up your awning area, the Coast LED Awning Lights are waterproof, and easily installed onto your RV by means of two screws. Featuring a pure white light, it runs on 12V DC and is available in two sizes.

**500-01250**  
**COAST LED AWNING LIGHT**  
**PURE WHITE (20CM)**  
 Contains 9 LEDs

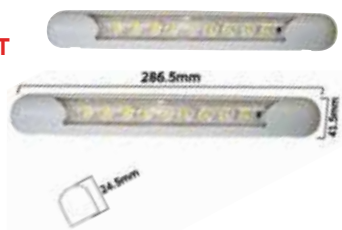

**500-01252**  
**COAST LED AWNING LIGHT PURE WHITE (40CM)**  
 Contains 18 LEDs

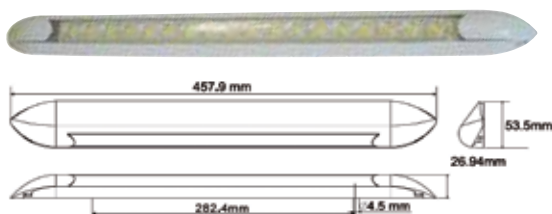

**500-01268**  
**LED INTERNAL ROOF**  
**LIGHT.53R TOUCH**  
**WARM WHITE**



## Specifications

Length: 158.5 mm  
 Width: 118.5 mm  
 Total Height: 16.5 mm

**500-01270**  
**LED INTERNAL ROOF**  
**LIGHT.53R TOUCH**  
**WARM WHITE**



## Specifications

Length: 236.5 mm  
 Width: 126.5 mm  
 Total Height: 16.5 mm

## LED OVAL LIGHTS

**500-01260**  
**COAST LED OVAL LIGHT 12V WITH**  
**JACK**



**500-01262**  
**COAST LED OVAL LIGHT 12V**



**500-01264**  
**COAST LED OVAL LIGHT 12V**  
**DUAL**



**500-01266**  
**COAST LED OVAL LIGHT 12V**  
**DUAL**  
**WITH JACK**



## 12V INTERNAL LIGHTS

**500-05000**  
**WHITE INTERIOR DOME LIGHT**  
**WITH ON/ OFF ROCKER SWITCH**



## Specifications

Dimensions (mm): 190W x 109H x 50D

**500-05001**  
**SILVER INTERIOR DOME LIGHT**  
**WITH ON/ OFF ROCKER SWITCH**



**500-05002**  
**WHITE DUAL INTERIOR DOME LIGHT**  
**WITH ON/ OFF ROCKER SWITCH**



## Specifications

Dimensions (mm): 280W x 109H x 50D

**500-05010**  
**LENS TO SUIT INTERIOR DOME LIGHTS**  
**(BOTH DUAL AND SINGLE INTERIOR**  
**LIGHTS)**



## LIGHTING

## NARVA L.E.D LIGHTS

**500-05020**  
LED SIDE MARKER LAMP RED/  
AMBER LED CHROME BASE



## Specifications

Dimensions (mm): 74 x 38

**500-05022**  
LED SIDE MARKER LAMP RED/  
AMBER  
WITH WHITE BASE



## Specifications

Dimensions (mm): 74 x 38

**500-05024**  
LED FRONT END OUTLINE MARKER  
LAMP WHITE WITH CHROME BASE



## Specifications

Dimensions (mm): 74 x 38

**500-05026**  
LED FRONT END OUTLINE MARKER  
LAMP WHITE WITH WHITE BASE



## Specifications

Dimensions (mm): 74 x 38

**500-05028**  
LED FRONT END OUTLINE MARKER  
OR EXTERNAL CABIN LAMP AMBER  
WITH CHROME BASE



## Specifications

Dimensions (mm): 74 x 38

**500-05030**  
LED FRONT END OUTLINE MARKER  
OR EXTERNAL CABIN LAMP AMBER  
WITH WHITE BASE



## Specifications

Dimensions (mm): 74 x 38

**500-05032**  
LED REAR END OUTLINE MARKER  
LAMP RED WITH CHROME BASE

0.5m of cable is provided. 9 - 33V



## Specifications

Dimensions (mm): 74 x 38

**500-05034**  
LED REAR END OUTLINE MARKER  
LAMP RED WITH WHITE BASE



## Specifications

Dimensions (mm): 74 x 38

**500-05036**  
LED SIDE DIRECTION INDICATOR  
LAMP AMBER WITH CHROME  
BASE

0.5m of cable is provided. 9 - 33V



## Specifications

Dimensions (mm): 74 x 38

**500-05040**  
LED LICENCE PLATE LAMP  
BLACK HOUSING



## Specifications

Dimensions (mm): 95 x 60

**500-05042**  
LENS TO SUIT SIDE MARKER  
LAMP



## Specifications

Dimensions (mm): 114 x 58

**500-05110**  
SIDE MARKER LAMP  
- RED/AMBER



## Specifications

Dimensions (mm): 120 x 65

## NARVA LAMPS &amp; REFLECTORS

**500-05100**  
**REAR COMBO LIGHT**  
**- STOP/PARK/DIRECTION**  
**INDICATOR**

With shallow body.

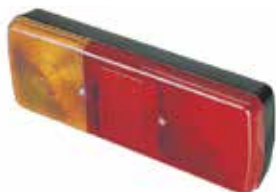
**Specifications**

Dimensions (mm): 275 x 93

**500-05102**  
**HEAVY DUTY REAR COMBO**  
**LAMP - STOP/DIRECTION**  
**INDICATOR**

With grey base.

**Specifications**

Dimensions (mm): 405 x 130

**500-05104**  
**HEAVY DUTY REAR COMBO**  
**LAMP**  
**- STOP/PARK/REVERSE/**  
**DIRECTION**  
**INDICATOR****Specifications**

Dimensions (mm): 650 x 132

**500-05112**  
**CLEAR FRONT END OUTLINE**  
**MARKER LAMP WITH BUILT IN**  
**REFLECTOR****Specifications**

Dimensions (mm): 85 x 38

**500-05114**  
**CLEAR FRONT END OUTLINE**  
**MARKER LAMP WITH RUBBER**  
**BOOT & BUILT IN REFLECTOR****Specifications**

Dimensions (mm): 97 x 48

**500-05120**  
**NARVA SIDE DIRECTION**  
**INDICATOR LAMP (AMBER)****Specifications**

Dimensions (mm): 120 x 52

**500-05015**  
**NARVA LED BLACK AWNING**  
**LIGHT****500-05119**  
**NARVA LARGE BASE LED**  
**AWNING LIGHT****500-05123**  
**NARVA LED AWNING LIGHT**

A low profile LED lamp that is great for positioning underneath an awning canopy on RVs. It has a classic shape with a white base (9-30VDC, 3W).

**Specifications**

Dimensions (mm): 250W x 87H x 17-35D

**500-05124**  
**NARVA FRONT END OUTLINE**  
**MARKER & FRONT POSITION**  
**LAMP (CLEAR)****Specifications**

Dimensions (mm): 120 x 52

**500-05125**  
**NARVA REAR END OUTLINE**  
**MARKER & REAR POSITION**  
**LAMP RED**

Can use 12V or 24V globes. ADR approved.

**Specifications**

Dimensions (mm): 120 x 52

## LIGHTING

## FESTOON GLOBES

**500-05150**  
**12V 3W GLOBE**

10 pack.

**Specifications**

Dimensions (mm): 8 x 28

**500-05152**  
**12V 5W GLOBE**

10 pack.

**Specifications**

Dimensions (mm): 11 x 36

**500-05154**  
**12V 5W GLOBE**

10 pack.

**Specifications**

Dimensions (mm): 11 x 41

**500-05156**  
**12V 10W GLOBE**

10 pack.

**Specifications**

Dimensions (mm): 11 x 36

**500-05162**  
**12V 18W GLOBE**

10 pack.

**Specifications**

Dimensions (mm): 15 x 41

**500-05164**  
**12V 18W GLOBE**

10 pack.

**Specifications**

Dimensions (mm): 15 x 44

## COAST LED LAMPS

**500-05500**  
**COAST LED SIDE MARKER**  
**LAMP RED/AMBER**

Has a clear polycarbonate lens with a white bracket, a 0.5m wire outlet with blade terminals (12V)

**Specifications**

Dimensions (mm): 75 x 40

**500-05502**  
**COAST LED FRONT POSITION**  
**LAMP WHITE**

Has a clear polycarbonate lens with a white bracket, a 0.5m wire outlet with blade terminals (12V)

**Specifications**

Dimensions (mm): 75 x 40

**500-05504**  
**COAST LED FRONT MARKER**  
**LAMP AMBER**

Has a clear polycarbonate lens with a white bracket, a 0.5m wire outlet with blade terminals (12V)

**Specifications**

Dimensions (mm): 75 x 40

**500-05506**  
**REAR POSITION LAMP RED**

Has a red polycarbonate lens with a white bracket, 0.5m wire outlet with blade terminals (12V)

**Specifications**

Dimensions (mm): 75 x 40

**500-05520****COAST LED LICENSE PLATE LAMP (WHITE)**

Has a polycarbonate lens with dark grey bracket & a 0.5m wire lead outlet. Note: there is no terminal or connector and two lamps are required for ADR compliance (12V DC)

**LED REPLACEMENT BULBS****500-05748****LED MR8 REPLACEMENT BULB (COOL WHITE) 0.8W**

Used to replace traditional MR8 halogen bulbs, it has x6 super bright LEDs and a luminous flux of 60 lumens. Operating on 12V DC, it is the equivalent to a 10W MR8 halogen bulb.

**Specifications**

Dimensions (mm): 34 x 25

**500-05751****LED MR16 REPLACEMENT BULB (COOL WHITE) 4W**

Used to replace the traditional MR16 halogen bulb, has x3 super bright LED's and a luminous flux of 210 lumens. Operating on 12V DC, it is the equivalent to a 45W MR16 halogen bulb.

**Specifications**

Dimensions (mm): 50 x 47.8

**500-05752****LED MR11 REPLACEMENT BULB (COOL WHITE) 1.8W**

Used to replace the traditional MR11 halogen bulb, has x12 super bright LEDs and a luminous flux of 150 lumens. Operating on 12V DC, it is the equivalent to a 24W MR11 halogen bulb.

**Specifications**

Dimensions (mm): 34 x 34.6

**500-05753****LED G4 REPLACEMENT BULB WITH SIDE PIN (COOL WHITE) 1.6W**

Used to replace the traditional G4 halogen bulbs, it has x6 super bright LEDs and a luminous flux of 120 lumens. Operates on 12V DC.

**Specifications**

Dimensions (mm): 35 x 23

**500-05754****LED G4 SINGLE REPLACEMENT BULB (COOL WHITE) 1W**

Used to replace reading light bulbs, it has a single super bright LED and a luminous flux of 70 lumens. Operating on 12V DC, it is the equivalent to a 10W G4 halogen bulb.

**Specifications**

Dimensions (mm): 28 x 12

**500-05756****LED G4 REPLACEMENT BULB WITH SIDE PIN (COOL WHITE) 1.8W**

Used to replace the traditional G4 halogen bulb, it has x12 super bright LEDs and a luminous flux of 150 lumens. Operating on 12V DC, it is the equivalent to a 27W G4 halogen bulb.

**Specifications**

Dimensions (mm): 42 x 30

**500-05757****LED G4 REPLACEMENT BULB TOWER TYPE (COOL WHITE) 2.7W**

Used to replace the traditional G4 halogen bulb, it has x18 super bright LEDs and a luminous flux of 210 lumens. Operating on 12V DC, it is the equivalent to a 27W G4 halogen bulb.

**Specifications**

Dimensions (mm): 45 x 15



## LED BULBS

**500-05758****LED T10 REPLACEMENT BULB (COOL WHITE) 1.35W**

Used to replace the traditional T10 halogen bulb, it has x6 super bright LEDs and a luminous flux of 105 lumens. Operating on 12V DC, it is the equivalent to a 16W T10 halogen bulb.

**Specifications**

Dimensions (mm): 37 x 13

**500-05764****LED BA15D REPLACEMENT BULB (COOL WHITE) 2.7W**

Used to replace traditional BA15D halogen bulbs, it has a double connector parallel pin and x18 super bright LEDs. Operating on 12V DC, and with a luminous flux of 250 lumens, it is the equivalent to a 36W BA15D halogen bulb.

**Specifications**

Dimensions (mm): 49 x 15

**500-05760****LED T10 REPLACEMENT BULB (COOL WHITE) 2.7W**

Used to replace the traditional T10 halogen bulb, it has x18 super bright LEDs and a luminous flux of 210 lumens. Operating on 12V DC, it is the equivalent to a 35W T10 halogen bulb.

**Specifications**

Dimensions (mm): 55 x 27

**500-05766****LED FESTOON REPLACEMENT BULB (COOL WHITE) 0.54W**

Used to replace traditional festoon halogen bulbs, it has x6 super bright LED's. Operating on 12V DC, and with a luminous flux of 36 lumens, it is the equivalent to a 5.4W festoon halogen bulb.

**Specifications**

Dimensions (mm): 42 x 24

**500-05761****LED T10 REPLACEMENT BULB WEDGE TYPE (COOL WHITE) 1.76W**

Used to replace the traditional T10 halogen bulb, it has x13 super bright LEDs and a luminous flux of 150 lumens. Operating on 12V DC.

**Specifications**

Dimensions (mm): 43.2 x 10

**500-05770****LED 2D FLUORESCENT TUBE REPLACEMENT LAMP (COOL WHITE) 10.1W**

Used to replace traditional round fluorescent lamps, it has x60 super bright LEDs. Operating on 12V DC, it has a luminous flux of 900 lumens.

**Specifications**

Dimensions (mm): 130 x 15

**500-05762****LED BA15S REPLACEMENT BULB (COOL WHITE) 2.7W**

Used to replace traditional BA15S halogen bulbs, it has a single connector parallel pin and x18 super bright LEDs. Operating on 12V DC, and with a luminous flux of 250 lumens, it is the equivalent to a 36W BA15S halogen bulb.

**Specifications**

Dimensions (mm): 49 x 15



## REFLECTORS

## REFLECTORS

**500-05550**  
**COAST RECTANGULAR SCREW**  
**MOUNT REFLECTOR AMBER**

Has an acrylic lens and screw mount.

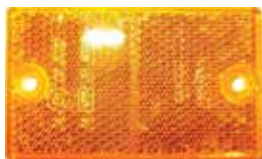
**Specifications**

Dimensions (mm): 72 x 42

**500-05552**  
**COAST RECTANGULAR**  
**SCREW MOUNT REFLECTOR**  
**RED**

Has an acrylic lens and screw mount.

**Specifications**

Dimensions (mm): 72 x 42

**500-05554**  
**COAST RECTANGULAR**  
**SCREW MOUNT REFLECTOR**  
**CLEAR**

Has an acrylic lens and screw mount.

**Specifications**

Dimensions (mm): 72 x 42

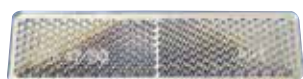
**500-05556**  
**REFLECTOR CLEAR**  
**RECTANGULAR SELF**  
**ADHESIVE 22 X 85MM**  
**ADR APPROVED****500-05558**  
**REFLECTOR RED**  
**RECTANGULAR SELF**  
**ADHESIVE 22 X 85MM**  
**ADR APPROVED****500-05560**  
**REFLECTOR AMBER**  
**RECTANGULAR SELF**  
**ADHESIVE 22 X 85MM**  
**ADR APPROVED****500-05580**  
**ROUND REFLEX**  
**REFLECTOR AMBER****Specifications**

Diameter: 57mm

Height: 5mm

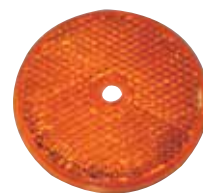
**500-05582**  
**ROUND REFLEX**  
**REFLECTOR RED****Specifications**

Diameter: 57mm

Height: 5mm

**500-05584**  
**ROUND REFLEX**  
**REFLECTOR CLEAR****Specifications**

Diameter: 57mm

Height: 5mm



# WIRELESS LIGHTING

## SPHERE™ WIRELESS LIGHTING CONTROL SYSTEM



The Sphere™ Wireless Lighting Control System is the way of the future. Easily installed on any flat surface, the system requires no drilling, no wires and no hassle—a simple lighting system at its best! How does the system work you ask? Firstly you will need the 6-Channel Receiver and a selection of Wireless Switches (whichever you feel is best for your RV setup). The Receiver will control the lighting for up to six individual zones in your RV e.g. the kitchen or the bathroom. A simple pairing procedure allows for multiple switches to be programmed to each zone and vice versa.

A master OFF function is available with all switches, enabling you to turn all lights off in all zones with one simple button. Alternatively, for a true wireless experience, the remote control can be purchased.

### 500-07132

#### SPHERE WIRELESS LIGHT SWITCH REMOTE CONTROL

A six button, multifunction remote control with six available channels enabling the user to tailor the system to their needs. The Remote Control is a handy accessory to keep in your pocket. If, for example, you have spent the day exploring your surroundings, with the Remote Control in your pocket, you can turn your RV lights on as you approach. It will work up to 50m away (provided nothing obscures the signal). Comes with a belt and clip for the user to wear when away from their RV.



### 500-07134

#### SPHERE WIRELESS LIGHT SWITCH REMOTE CONTROL WITH MASTER OFF

A six button, multifunction remote control with six available channels enabling the user to tailor the system to their needs.



### 500-07200

#### 1-GANG WIRELESS SWITCH

Comes with x2 CR2032 lithium batteries.



#### Specifications

Battery Type: CR2032 Lithium Battery

Working Frequency: 433.92MHz

## WIRELESS LIGHTING

**500-07204****2-GANG WIRELESS SWITCH**

Comes with x2 CR2032 lithium batteries

**500-07218****5-GANG WIRELESS SWITCH WITH MASTER OFF**

Comes with x2 CR2032 lithium batteries

**500-07206****2-GANG WIRELESS SWITCH WITH MASTER OFF**

Comes with x2 CR2032 lithium batteries

**500-07220****6-GANG WIRELESS SWITCH**

Comes with x2 CR2032 lithium batteries

**500-07208****3-GANG WIRELESS SWITCH**

Comes with x2 CR2032 lithium batteries

**500-07222****6-GANG WIRELESS SWITCH WITH MASTER OFF**

Comes with x2 CR2032 lithium batteries

**500-07210****3-GANG WIRELESS SWITCH WITH MASTER OFF**

Comes with x2 CR2032 lithium batteries

**500-07300****6-CHANNEL (12V RECEIVER)****500-07212****4-GANG WIRELESS SWITCH**

Comes with x2 CR2032 lithium batteries

**500-07214****4-GANG WIRELESS SWITCH WITH MASTER OFF**

Comes with x2 CR2032 lithium batteries

**500-07216****5-GANG WIRELESS SWITCH**

Comes with x2 CR2032 lithium batteries



## BLADE FUSES

**500-08400**  
**NARVA 10 AMP RED ATS BLADE FUSE**  
 - 50 PER BOX



**500-08414**  
**NARVA 25 AMP CLEAR ATS BLADE FUSE**  
 - 5 PER PACK



**500-08402**  
**NARVA 10 AMP RED ATS BLADE FUSE**  
 - 5 PER PACK



**500-08416**  
**NARVA 30 AMP GREEN ATS BLADE FUSE**  
 - 50 PER BOX



**500-08404**  
**NARVA 15 AMP BLUE ATS BLADE FUSE**  
 - 50 PER BOX



**500-08418**  
**NARVA 30 AMP GREEN ATS BLADE FUSE**  
 - 5 PER PACK



**500-08406**  
**NARVA 15 AMP BLUE ATS BLADE FUSE**  
 - 5 PER PACK



**500-08420**  
**NARVA 40 AMP LIGHT BROWN ATS BLADE FUSE**  
 - 50 PER BOX



**500-08408**  
**NARVA 20 AMP YELLOW ATS BLADE FUSE**  
 - 50 PER BOX



**500-08422**  
**NARVA 40 AMP LIGHT BROWN ATS BLADE FUSE**  
 - 5 PER PACK



**500-08410**  
**NARVA 20 AMP YELLOW ATS BLADE FUSE**  
 - 5 PER PACK



**500-08424**  
**NARVA 30 AMP GREEN MAXI-BLADE FUSE**  
 - 10 PER BOX



**500-08412**  
**NARVA 25 AMP CLEAR ATS BLADE FUSE**  
 - 50 PER BOX



**500-08426**  
**NARVA 30 AMP GREEN MAXI-BLADE FUSE**  
 - 1 PER PACK



## NARVA ELECTRICAL FITTINGS

500-08428

NARVA 40 AMP AMBER MAXI-BLADE  
FUSE - 10 PER BOX

500-08442

NARVA 80 AMP CLEAR MAXI-BLADE  
FUSE - 1 PER PACK

500-08430

NARVA 40 AMP AMBER MAXI-BLADE  
FUSE - 1 PER PACK

500-08444

NARVA 100 AMP PURPLE MAXI-  
BLADE FUSE - 10 PER BOX

500-08432

NARVA 50 AMP RED MAXI-BLADE  
FUSE - 10 PER BOX

500-08446

NARVA 100 AMP PURPLE MAXI-  
BLADE FUSE - 1 PER PACK

500-08434

NARVA 50 AMP RED MAXI-BLADE  
FUSE - 10 PER BOX

## INLINE FUSE HOLDERS

500-08448

NARVA IN-LINE STD ATS BLADE  
FUSE HOLDER (30A MAX)  
- 1 PER PACK

500-08436

NARVA 60 AMP BLUE MAXI-BLADE  
FUSE - 10 PER BOX

500-08450

NARVA IN-LINE STD ATS BLADE  
FUSE HOLDER (30A MAX)  
- 10 PER BOX

500-08438

NARVA 60 AMP BLUE MAXI-BLADE  
FUSE - 1 PER PACK

500-08452

NARVA IN-LINE MAXI BLADE FUSE  
HOLDER (60A MAX)  
- 1 PER PACK (BLISTER PAC)

500-08440

NARVA 80 AMP CLEAR MAXI-BLADE  
FUSE - 10 PER BOX

500-08454

NARVA IN-LINE MAXI BLADE FUSE  
HOLDER (60A MAX) - 1 PER BOX

## BLADE TERMINALS

**500-08456**

**NARVA 6.3X0.8MM TRANS- RED  
MALE BLADE TERMINAL T/S 2.5-  
3MM - 50 PER BOX**



**500-08458**

**NARVA 6.3X0.8MM TRANS-BLUE  
MALE BLADE TERMINAL T/S 4MM -  
50 PER BOX**

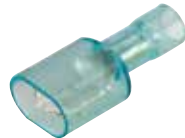

**500-08460**

**NARVA 6.3X0.8MM TRANS-YELLOW  
MALE BLADE TERMINAL T/S 5-6MM  
- 50 PER BOX**



**500-08462**

**NARVA 6.3X0.8MM RED FLARED  
MALE BLADE TERMINAL T/S 2.5-  
3MM  
- 100 PER BOX**



**500-08464**

**NARVA 6.3X0.8MM BLUE FLARED  
MALE BLADE TERMINAL T/S 4MM  
- 100 PER BOX**



**500-08466**

**NARVA 6.3X0.8MM YELLOW FLARED  
MALE BLADE TERMINAL T/S 5-6MM  
- 100 PER BOX**



**500-08468**

**NARVA 6.3X0.8MM RED FEMALE  
BLADE TERMINAL T/S 2.5-3MM - 100  
PER BOX**



**500-08470**

**NARVA 6.3X0.8MM BLUE FEMALE  
BLADE TERMINAL T/S 4MM - 100  
PER BOX**



**500-08472**

**NARVA 6.3X0.8MM BLUE FEMALE  
BLADE TERMINAL T/S 4.8MM - 100  
PER BOX**



**500-08474**

**NARVA 6.3X0.8MM YELLOW FEMALE  
BLADE TERMINAL T/S 5-6MM - 100  
PER BOX**



**500-08476**

**NARVA 6.3X0.8MM TRANS-RED  
FEMALE BLADE TERMINAL T/S 2.5-  
3MM - 100 PER BOX**



**500-08478**

**NARVA 6.3X0.8MM RED FEMALE  
BLADE TERMINAL T/S 2.5-3MM - 100  
PER BOX**



**500-08480**

**NARVA 6.3X0.8MM TRANS-BLUE  
FEMALE BLADE TERMINAL T/S 4MM -  
100 PER BOX**



**500-08482**

**ARVA 6.3X0.8MM BLUE FEMALE  
BLADE TERMINAL T/S 4MM - 100  
PER BOX**



**500-08484**

**NARVA 6.3X0.8MM TRANS-YELLOW  
FEMALE BLADE TERMINAL T/S  
5-6MM - 100 PER B**



## NARVA ELECTRICAL FITTINGS

500-08486

NARVA 4.0MM RED MALE BULLET  
TERMINAL T/S 2.5-3MM - 100 PER  
BOX



500-08502

NARVA 4.0MM TRANS-BLUE FEMALE  
BULLET TERMINAL T/S 4MM - 100  
PER BOX



500-08488

NARVA 4.0MM TRANS-RED MALE  
BULLET TERMINAL T/S 2.5-3MM -  
100 PER BOX



500-08504

NARVA 5.0MM YELLOW FEMALE  
BULLET TERMINAL T/S 5-6MM - 100  
PER BOX



## SPLICE JOINERS

500-08490

NARVA 5.0MM BLUE MALE BULLET  
TERMINAL T/S 4MM - 100 PER BOX



500-08506

NARVA RED BUTT SPLICE CABLE  
JOINER T/S 2.5-3MM  
- 100 PER BOX.



500-08492

NARVA 4.0MM TRANS-BLUE MALE  
BULLET TERMINAL T/S 4MM - 100  
PER BOX



500-08508

NARVA BLUE BUTT SPLICE CABLE  
JOINER T/S 4MM  
- 100 PER BOX



500-08494

NARVA 5.0MM YELLOW MALE  
BULLET TERMINAL T/S 5-6MM  
- 100 PER BOX



500-08510

NARVA YELLOW BUTT SPLICE  
CABLE JOINER T/S 5-6MM  
- 100 PER BOX



## RING TERMINALS

500-08496

NARVA 4.0MM RED FEMALE BULLET  
TERMINAL T/S 2.5-3MM  
- 100 PER BOX



500-08512

NARVA 8.4MM RED RING TERMINAL  
T/S 2.5-3MM  
- 100 PER BOX



500-08498

NARVA 4.0MM TRANS-RED FEMALE  
BULLET TERMINAL T/S 2.5-3MM  
- 100 PER BOX



500-08514

NARVA BLUE 8.4MM BLUE RING  
TERMINAL T/S 4MM  
- 100 PER BOX



500-08500

NARVA 5.0MM BLUE FEMALE  
BULLET TERMINAL T/S 4MM  
- 100 PER BOX



500-08516

NARVA 8.4MM YELLOW RING  
TERMINAL T/S 5-6MM  
- 100 PER BOX





**500-08518**  
NARVA 9.5MM YELLOW RING  
TERMINAL T/S 5-6MM - 100 PER BOX



## BARREL LUGS

**500-08520**  
NARVA 10MMSQ 8MM STUD  
STRAIGHT BARREL CABLE LUG  
- 10 PER BOX



**500-08522**  
NARVA 10MMSQ 10MM STUD  
STRAIGHT BARREL CABLE LUG  
- 10 PER BOX



**500-08524**  
NARVA 25MMSQ 8MM STUD  
STRAIGHT BARREL CABLE LUG  
- 10 PER BOX



**500-08526**  
NARVA 25MMSQ 10MM STUD  
STRAIGHT BARREL CABLE LUG  
- 10 PER BOX



## ELECTRICAL TAPE

**500-08580**  
NARVA 19MM PVC BLACK  
INSULATION TAPE - 10 ROLLS



**500-08582**  
NARVA 19MM PVC BLACK FLAME  
RETARDANT INSULATION TAPE - 10  
ROLLS



## POWER INLETS & OUTLETS

**500-09000**  
POWER INLET SOCKET 15A IN  
WHITE



**500-09002**  
POWER INLET SOCKET 15A IN  
BLACK



**500-09004**  
POWER OUTLET SOCKET 10A IN  
WHITE



**500-09006**  
POWER OUTLET SOCKET 10A IN  
BLACK



**500-09012**  
MOUNTING FLANGE  
13MM IN WHITE



## POWER INLETS &amp; OUTLETS

**500-09014**  
MOUNTING FLANGE  
13MM IN BLACK



**500-09062**  
SINGLE POWER POINT DOUBLE  
POLE DEEP  
IN WHITE



**500-09016**  
MOUNTING FLANGE  
20MM IN WHITE

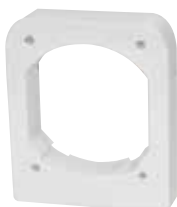

**500-09064**  
DOUBLE POWER POINT 10A  
DOUBLE POLE DEEP



**500-09018**  
MOUNTING FLANGE  
20MM IN BLACK



**500-09070**  
ARCHITRAVE SWITCH  
1 GANG WHITE



**500-09050**  
POWER POINT SINGLE 10A  
DOUBLE POLE



**500-09072**  
ARCHITRAVE SWITCH 1  
GANG BLACK



**500-09052**  
POWER POINT DOUBLE 10A  
DOUBLE POLE



**500-02600**  
NARVA 12 PIN FLAT  
TRAILER PLUG  
7 pole amp rating per pole 15A at 12V.5  
pole amp rating per pole 35A at 12V



**500-09054**  
POWER POINT DOUBLE POLE  
10A WITH DUAL USB CHARGER



**500-02602**  
NARVA 12 PIN TRAILER SOCKET  
7 pole amp rating per pole 15A at 12V  
5 pole amp rating per pole 35A at 12V



**500-09056**  
QUAD POWER POINT 10A  
DOUBLE POLE



**500-03002**  
**FLAP TO SUIT CLIPSAL OLD**  
**STYLE INLET**



**500-03032**  
**FLAP TO SUIT CLIPSAL NEW**  
**STYLE OUTLET**

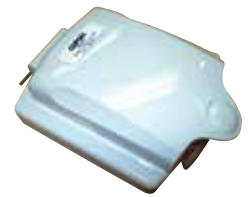

**500-03020**  
**CLIPSAL (NEW) WHITE EXTERNAL**  
**15A POWER INLET**

A flush inlet with weatherproof flap. (Ensure the cable shroud is secured after cable connections).



**500-03050**  
**CLIPSAL MOUNTING FLANGE**  
**TO SUIT NEW STYLE INLET/**  
**OUTLET**



**500-03021**  
**CLIPSAL BLACK EXTERNAL 15AMP**  
**POWER INLET**



**500-03052**  
**CLIPSAL MOUNTING FLANGE TO**  
**SUIT OLD STYLE INLET/OUTLET**



**500-03022**  
**FLAP TO SUIT CLIPSAL NEW STYLE**  
**INLET**



**500-03054**  
**CLIPSAL MOUNTING FLANGE BLACK**  
**T/S NEW STYLE INLET**



**500-03028**  
**CLIPSAL (NEW) BLACK EXTERNAL 10**  
**AMP POWER OUTLET**



**500-03101**  
**CLIPSAL COVER TO SUIT**  
**CIRCUIT BREAKER (SLIM)**  
 An 18mm wide cover to suit single circuit  
 breakers (such as 500-03105)



**500-03030**  
**CLIPSAL (NEW) WHITE EXTERNAL**  
**10A POWER OUTLET WITH**  
**WATERPROOF FLAP**



## ELECTRICAL LEADS

**500-03102****CLIPSAL COVER TO SUIT CIRCUIT BREAKER**

Suitable for covering 36mm wide circuit breakers.

**500-03105****CIRCUIT BREAKER (WITH EARTH LEAKAGE)**

Clipsal Max 4 - combination residual current devices and miniature circuit breaker, remember to test these on a monthly basis by operating their inbuilt test button, standard slim type, non-delayed, 240V, 16A - 30mA, 1-phase +N, 6kA, 1 module wide, 50Hz.

**500-03110****CLIPSAL 75 OHM COAXIAL CABLE SURFACE SOCKET**

These sockets are designed to accommodate solid core conductor coaxial cables with insulation up to 5mm (diameter) for solderless connections.

**500-03120****CLIPSAL 492/32 FIXED POLARITY PLUG GREY**

Flexible two-pin plugs do not require insulated pins to comply with Australian/New Zealand Standards. This is a flexible plug with two parallel pins, 10A.

**500-03122****CLIPSAL 438/32 FIXED POLARITY CORD SOCKET GREY**

32V Socket, 15A 2pin polar to suit 1.5mm<sup>2</sup> (ordinary duty)

**500-03124****402/32 FIXED POLARITY SOCKET WHITE**

Front connecting surface socket with two polarized pins, 32V, 15A.

**500-03200****SINGLE POWER OUTLET DOUBLE POLE 15D WHITE**

Double pole power outlet single, 250V, 10A.

**500-03204****DOUBLE POWER OUTLET DOUBLE POLE 25D WHITE**

Twin (standard) size horizontal mount power outlet with double plate, 250V, 10A.

**500-03206****MOUNTING BLOCK WHITE**

Moulded mounting block, one gang to suit all standard size accessories.

**500-03208****DOUBLE POLE SWITCH 30D WHITE**

Conventional architrave switch, the terminals accommodate 3 x 2.5mm sq. cables. 250V 10A AC only.

**500-03400****ELECTUS ANDERSON PLUG (50AMP)**

A 50A, high current connector that is used in domestic and industrial applications e.g. 4WD, boating and automotive. It comes with a pair of contacts.

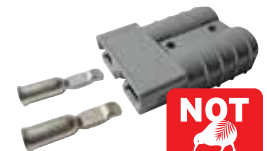
**Specifications**

Contact Wire Size: 6AWG

Voltage Rating: 600V (AC or DC)

Max Wire Insulation Diameter: 11mm

## ELECTRICAL LEADS

500-06562

NARVA HD 50AMP CONNECTOR  
HOUSING GRY

500-06563

NARVA HD 50AMP CONNECTOR  
HOUSING BLK

500-06564

NARVA HD 50AMP CONNECTOR  
HOUSING RED

## COAST HEAVY DUTY EXTENSION LEADS

Coast to Coast's new extension leads offer you a wider variety of length options so you can find the perfect sized lead for your RV or campsite, including an extra short size of 8m and extra-long size of 25m!

Our new leads are LED equipped and made from a 3 core, 1.5mm<sup>2</sup> cable with a moulded 15A plug and socket. To protect the face of the socket, they have a full 360° projecting shroud as well. All of Coast's extension leads are approved and manufactured to Australian Standards and are not suitable for use with domestic power points. Keep your site powered from any distance, with Coast to Coast's new heavy-duty extension leads!

500-03549

COAST 8M/15AMP HEAVY DUTY 240V  
EXTENSION LEAD  
- LED EQUIPPED

500-03551

COAST 12M/15AMP HEAVY DUTY  
EXTENSION LEAD  
- LED EQUIPPED

500-03553

COAST 17M/15AMP HEAVY DUTY  
EXTENSION LEAD  
- LED EQUIPPED

500-03555

COAST 22M/15AMP HEAVY DUTY  
EXTENSION LEAD  
- LED EQUIPPED

500-03557

COAST 25M/15AMP HEAVY DUTY  
EXTENSION LEAD  
- LED EQUIPPED

500-03600

CMS SINGLE POWER OUTLET  
(BEIGE)

A 10A power outlet that comes with a 20A installation coupler, and is double pole switched.



500-03602

CMS SINGLE POWER OUTLET  
(WHITE)

A 10A power outlet that comes with a 20A installation coupler, and is double pole switched.



500-03610

CMS DOUBLE POWER  
OUTLET (BEIGE)

Power Point Beige.



## CMS EQUIPMENT

## INTERCONNECTING LEAD 20A

Ordinary duty leads are manufactured from 3 core 2.5sqmm flexible cable. They are rated at 20A terminated with male and female connectors.



Part Number	Description
500-03700	CMS 500mm interconnecting lead 20A beige
500-03710	CMS 1000mm interconnecting lead 20A beige
500-03720	CMS 1300mm interconnecting lead 20A beige
500-03730	CMS 1500mm interconnecting lead 20A beige
500-03740	CMS 1700mm interconnecting lead 20A beige
500-03750	CMS 2000mm interconnecting lead 20A beige
500-03760	CMS 2300mm interconnecting lead 20A beige
500-03770	CMS 2500mm interconnecting lead 20A beige
500-03790	CMS 2700mm interconnecting lead 20A beige
500-03800	CMS 3000mm interconnecting lead 20A beige
500-03810	CMS 3200mm interconnecting lead 20A beige
500-03820	CMS 3300mm interconnecting lead 20A beige
500-03830	CMS 3500mm interconnecting lead 20A beige
500-03840	CMS 3800mm interconnecting lead 20A beige
500-03850	CMS 4000mm interconnecting lead 20A beige
500-03860	CMS 4200mm interconnecting lead 20A beige
500-03870	CMS 4500mm interconnecting lead 20A beige
500-03880	CMS 4700mm interconnecting lead 20A beige
500-03890	CMS 5000mm interconnecting lead 20A beige
500-03910	CMS 5500mm interconnecting lead 20A beige
500-03920	CMS 5700mm interconnecting lead 20A beige
500-03930	CMS 6000mm interconnecting lead 20A beige
500-03940	CMS 6300mm interconnecting lead 20A beige
500-03950	CMS 6500mm interconnecting lead 20A beige
500-03960	CMS 6800mm interconnecting lead 20A beige

## CIRCUIT BREAKER CONNECTING LEAD 20A BEIGE



Part Number	Description
500-04000	CMS 1000mm Circuit breaker connecting lead 20A beige
500-04010	CMS 2000mm Circuit breaker connecting lead 20A beige
500-04050	CMS 3500mm Circuit breaker connecting lead 20A beige
500-04070	CMS 4400mm Circuit breaker connecting lead 20A beige
500-04100	CMS 6300mm Circuit breaker connecting lead 20A beige

**500-04150**  
**CMS CIRCUIT BREAKER LOOM**  
**ASSY W/H REMOTE EARTH**  
**WIRE**

The CMS Circuit Breaker with Loom Assembly is a protective device that combines two functions, it acts as a residual current device and as a circuit breaker. It comes with a remote earth wire and features CMS' soft-wire interconnecting leads for a fast and simple installation.

- > 240V
- > 16A-30mA
- > 4.5kA
- > SAA120741EA AS/NZs61009.1

**500-04200**  
**CMS MOUNTING BLOCK**

Mounting block for power points and switch plates beige.

**500-04202**  
**CMS MOUNTING BLOCK**  
**(WHITE)**

Mounting block for power points and switch plate.



**500-04210**

**CMS SINGLE SWITCH PLATE**

Single switch plate, beige only. (Extra low voltage only eg 12V, Not for 240V)



**500-04282**

**CMS MOUNTING SHROUD**

CMS mounting shroud for outlets and switch plates (black).



**500-04220**

**CMS DOUBLE SWITCH PLATE**

Double switch plate, beige only. (Extra low voltage only eg 12V, Not for 240V)



**500-04284**

**CMS MOUNTING SHROUD**

CMS mounting shroud for outlets and switch plates (white).



**500-04230**

**CMS TRIPLE SWITCH PLATE**

Triple switch plate, beige only. (Extra low voltage only eg 12V, Not for 240V)



**500-04300**

**CMS 2-WAY 10A SWITCH**

250V 2-way with looping terminal (without indicator).



**500-04250**

**CMS TV ANTENNA OUTLET BEIGE**

Connects your TV to the aerial on your RV's roof. Fits into the wall of your RV.



**500-04310**

**CMS 10A DOUBLE POLE SWITCH SOCKET**

Suitable for use with CMS interconnecting leads only, direct connection.

**Recess Required:** 61mm

250V, 50Hz, 20Amp installation coupler



**500-04254**

**CMS TV ANTENNA OUTLET WHITE**



**500-04312**

**CMS 15A POWER INLET**

Suitable for use with CMS interconnecting leads only, direct connection.

**Recess Required:** 61mm

250V, 50Hz, 20A installation coupler.



**500-04262**

**CMS 1-IN 2-OUT DOUBLE ADAPTOR (CLEAR)**

J Series



**500-04313**

**CMS 15AMP PLUG POWER INLET BLACK**



**500-04280**

**CMS MOUNTING SHROUD**

CMS mounting shroud for outlets and switch plates (beige).



## 10 AMP - 15 AMP ADAPTORS

500-04314

**CMS TWIN DOUBLE POLE AUTO SOCKET**

A 20A installation coupler with a 10A socket outlet. (250V, 50Hz)



500-04316

**CMS 15AMP SINGLE 15A AUTO SWITCH INLET BLACK WITH RCD SWITCH**

500-04318

**CMS 15AMP SINGLE 15A AUTOS WITCH INLET WHITE WITH RCD SWITCH**

500-04320

**CMS 3 WAY ADAPTOR (BEIGE)**

20A, 240V, IP4X

**CMS POWER OUTLETS**

240v CMS Electrical products are not your usual fittings as they feature a soft-wire install with interconnecting leads instead of the hard-wire install of standard fittings. The advantage to this is that it is fast and simple to install or un-install as it is just a coupling connection to a lead rather than hard-wiring actual wire to connect the fitting.

500-04400

**DOUBLE NATURAL - WHITE**

500-04402

**SINGLE N/W + DUAL 4A USB W/12VDC TERMINAL****15AMP TO 10 AMP ADAPTORS**

500-04504

**ELECTUS PORTABLE RCD WITH 15A TO 10A MAINS PLUG CONVERSION**

Featuring a 10A circuit breaker/RCD for overload protection, this portable RCD is ideal if you have a device with a 15A mains plug but no 15A power outlet available.

**Specifications**

**Voltage:** 240V AC, 50Hz

**Max Load:** 2400W, 10A

**Rated Residual Current:** 30mA

**Dimensions:** 180H x 135D x 124W (mm)

500-04501

**AMP-FIBIAN RV-O2MAX 15AMP TO 10AMP ADAPTER**

The Ampfiban adaptor allows for a 15A load (e.g. that of a caravan) to connect to a standard household power point (10A). With upgraded features such as being waterproof to IP55, being able to accept leads up to 12mm in diameter and with a new H-Class rating, the Ampfiban is the safe option to connect to domestic outlets. It will automatically trip at 10A if the power outlet becomes overloaded. Designed and made in Australia, the Ampfiban comes with RCD and overload protection, as well as a two year warranty.



500-04503

**AMP-FIBIAN MINI 15AMP TO 10AMP ADAPTER**

Suitable for use where a waterproof rating is not essential, the Ampfiban Mini has all the same features as its big brother but with an IP33 rating. It has all the essentials such as RCD and overload protection, and a 10A circuit breaker which prevents overloading by cutting the power if it exceeds 10A (2400W). Designed and made in Australia, it comes with a two year manufacturer's warranty.

**Specifications**

**Class:** L - suitable for DIY/Handyman jobs

**RCD:** 30mA, 10kA fault current

**Power:** 220-240VAC, 50-60Hz



# NARVA ACCESSORY SOCKETS

## 500-04506

### AMP-FIBIAN RV-PLUS 15AMP TO 10AMP ADAPTER WITH OVERLOAD

The Ampfiban RV Plus is the perfect power adapter for caravan/RV owners. Compact for travel, and weatherproof for outdoor use, it lets 15A devices connect legally to 10A power points and includes fast acting earth leakage safety protection.



#### Features

- > It is water resistant to IP-55 (jets of water from all directions) and made from impact resistant plastic.
- > Works with ordinary and heavy-duty caravan leads up to 12mm diameter.
- > 240V 10A 2400W circuit breaker
- > R.C.D. for personal protection
- > Padlock attachment point locks lid
- > Power indicator light in socket
- > Certified to comply with Australian Standards AS/NZS-3190 & AS/NZS-3001
- > Two year warranty
- > Designed & Made in Australia)

## 500-04508

### AMP-FIBIAN WEATHERPROOF CARAVAN SURGE PROTECTOR

Australia's only portable 15A caravan surge protector! Protects your inverter and electronic gear from power spikes and surges. Rated at 15 Amps, with a 1000 Joule power absorption rating and four integrated fuses, this touch little product protects your expensive investment.



#### Features

- > Red warning light tells you if the power point is incorrectly wired before plugging in
- > Tough weatherproof housing seals the connection and allows you to see the indicator lights.
- > Two spring-loaded cleats stop the caravan lead pulling out
- > Flip-up hook lets you hang it off the ground
- > 15 Amp plug goes into the site's power supply or generator before your caravan.
- > Compatible with Ampfiban 15A to 10A Power Adaptors
- > Meets Australian and New Zealand electrical standards (AS/NZS 3120:2011)

#### Specifications

240V / 50Hz / 15A / 3600W  
1000 Joule protection  
Meets AS/NZ 3120:2011  
IP55 Weatherproof

## 500-04509

### AMP-FIBIAN WEATHERPROOF CARAVAN SURGE PROTECTOR REPLACEMENT CARTRIDGE



## 500-04520

### POD 15 AMP TO 10 AMP ADAPTER

Designed in South Australia, the POD is great for the RV and tradie industry.

Its yellow and compact housing, makes it a portable powerhouse resulting in an efficient 15Amp to 10Amp power adapter. It has water ingress protection (IP55) and has been tested to comply with AS/NZ3190:2011. Safety comes first with the POD, it also features RCD overload protection as well as an inbuilt circuit breaker for current overload protection. Other handy features include a clear lid for easy inspection, a cord clamp to ensure your domestic supply cannot pull free and a convenient hook for hanging when in use. Comes with a one year manufacturer's warranty.



#### Specifications

Max loading: 10A

Suits ordinary duty 15A leads & features a 1.5m lead

## NARVA ACCESSORY SOCKETS

## 500-05070

### SURFACE MOUNT ACCESSORY SOCKET

Ideally suited for RV and marine type applications, the socket has a dustproof rubber cover and a plastic housing. It is suitable for interior or exterior installations, however in the case of an exterior fitment, the socket opening should point towards the ground. Comes in a single blister pack.



#### Specifications

Amperage Rating: 20A at 12V, 10A at 24V

Dimensions (mm): 80 x 50

## NARVA ACCESSORY SOCKETS

**500-05072****NARVA SURFACE MOUNT ACCESSORY (BLACK)**

Features dustproof cover and heavy-duty construction. Can be installed with or without the mounting panel. The fitting mechanism allows installation into interior or exterior panels including steel and aluminium. Can be installed with or without the mounting panel.



Moulded housing allows fitment to interior or exterior panels for easy installation.

**Specifications**

Rating: 20A at 12V, 10A at 24V

Dimensions (mm): 80 x 55

**500-05304****ACCESSORY SOCKET H/D****Specifications**

Amperage Rating: 20A at 12V, 10A at 24V

Mounting Opening: 29mm diameter

**500-05312****ACCESSORY SOCKET DUAL USB H/D****Specifications**

Output: 5V, 2.5A

Mounting Opening: 29mm diameter

**500-05318****ACCESSORY SOCKET TWIN ACCESSORY/ DUAL USB H/D****Specifications**

USB Output: 5V, 2.5A

Mounting Opening: 29mm diameter

**500-05322****ACCESSORY SOCKET SURFACE MOUNT DUAL USB H/D****Specifications**

USB Output: 5V, 2.5A

**500-05324****ACCESSORY SOCKET SURFACE BLACK MOUNT TWIN SOCKETS H/D****Specifications**

Amperage Rating: 20A at 12V, 10A at 24V per socket

**500-05325****ACCESSORY SOCKET WHITE SURFACE MOUNT TWIN SOCKETS H/D****Specifications**

Amperage Rating: 20A at 12V, 10A at 24V per socket

**500-05332****ACCESSORY SOCKET SURFACE MOUNT TWIN ACCESSORY / DUAL USB H/D****Specifications**

Accessory Socket: 20A at 12V, 10A at 24V

USB Output: 5V, 2.5A

Mounting Opening: 9mm diameter per socket

**500-05334****ACCESSORY SOCKET WHITE SURFACE MOUNT TWIN ACCESSORY / DUAL USB H/D****Specifications**

Accessory Socket: 20A at 12V, 10A at 24V

USB Output: 5V, 2.5A

**500-05340****ACCESSORY SOCKET H/D AND 12/24V DC L.E.D VOLT METER**

Easy to read L.E.D Volt Meter displays accurate battery voltage level.

**Specifications**

Accessory Socket: 20A at 12V, 10A at 24V

Volt Meter Range: 6-33V DC

## SOLAR EQUIPMENT

## COAST SOLAR PANELS



Coast to Coast's solar panels are made from 100% silicon wafers, not cut-offs like some lesser quality panels. They also have a silicon nitride (SiN) antireflective coating to ensure more light is absorbed in all weather conditions.

## Features

- > By-passed diodes to minimise power drops caused by shade
- > An anodised aluminium frame to withstand rust
- > Anti-reflective, high transparency tempered glass for durability

## 500-06121

## SOLAR PANEL 105W MONO-CRYSTALLINE SLIMLINE

## Specifications

Max Power Voltage: 18.0V  
 Max Power Current: 6.0A  
 Dimensions: 1310mm x 506mm x 35

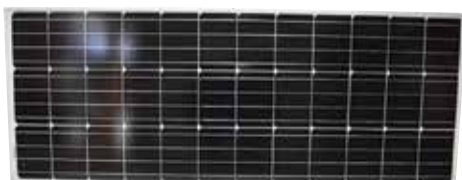

## 500-06122

## MONO CRYSTALLINE 130W PANEL SLIMLINE

## Specifications

Max Power Voltage (V<sub>pm</sub>): 17.6V  
 Max Power Current (I<sub>pm</sub>): 6.8A  
 Dimensions: 1196m x 674mm x 40mm  
 Weight (kg): 10.8



## 500-06124

## SOLAR PANEL 180W MONO-CRYSTALLINE

## Specifications

Max Power Voltage: 18.0V  
 Max Power Current: 8.89A  
 Dimensions: 1482mm x 674mm x 35mm  
 Weight (kg): 10.8

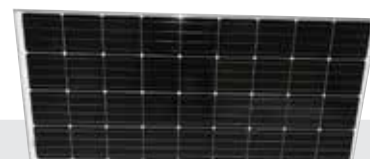

**500-06170****SOLAR PANEL MOUNTING BRACKETS (PACK 4)**

Suitable for use when installing any of the Coast to Coast solar panels. Note that in the case of the 150W solar panel, two sets are recommended to provide extra support.

**500-06172****SOLAR PANEL UNIVERSAL MOUNT KIT**

Sold as a kit containing: x4 corner mounts (top and bottom), x2 centre mounts (top and bottom), x20 locking screws and x40 height adjusting screws (x20 large for a 35mm frame and x20 small for a 40mm frame).

**SPHERE SOLAR CHARGE REGULATORS**

Solar power is one of the most convenient and portable ways to power your campsite! Now, you can take control of your power with Sphere's new Solar Charge Regulators! Direct the flow of your solar power where you need it most, with a simple and user-friendly design and built-in protection against overcharges.

**500-06220****SPHERE PWM 12V/24V 40A SOLAR CHARGE CONTROLLER**

The Sphere PWM Solar Charge Controller adopts an upgraded 3-stage PWM charging algorithm, which applies an equalizing charge to the battery periodically to prevent it from non-equalization and sulfuration, extending the battery's service life (with the exception of GEL and lithium batteries). Boasting an industrial grade design, the Solar Charge Controller is able to function in various tough conditions with TVS lighting protection.



- > Advanced 3-stage PWM charging algorithm
- > Overload, overcharge, and over-discharge protection
- > Dot Matrix Graphic LCD Screen
- > Multiple charging options for various battery types
- > Automatically recognises 12V/24V system voltages
- > User-friendly design with intuitive operations

**Specifications**

**Rated Current:** 40A  
**Max PV Input:** 600W/12V  
**Max. Solar Energy Input Voltage:** < 55V  
**Max. Voltage at Battery End:** < 34V

**500-06222****SPHERE MPPT 12V/24V 40A SOLAR CHARGE CONTROLLER**

With advanced dual-peak or multi-peak tracking technology, the Sphere MPPT Controller is still able to accurately track the maximum power point even when the solar panel is shadowed or partly fails.

The controller is equipped with an LCD screen which can display abnormality information to help users to quickly identify system faults.



- > Advanced dual-peak or multi-peak technology
- > Built-in maximum power point tracking algorithm
- > MPPT tracking efficiency up to 99.9% with advanced conversion efficiency to as high as 98%
- > Multiple charging options for various battery types
- > Automatic recognition of battery voltage
- > LED fault indicators and an LCD Screen
- > Built-in over-heating protection mechanism

**Specifications**

**Rated Charging Current:** 40A  
**Max PV Input:** 550W/12V  
**System Voltage:** 12V/24V Auto  
**Max. Solar input Voltage:** 100, 90V

**SPHERE TYRE INFLATORS****500-06300****SPHERE SWIFT TYRE INFLATOR 28L/MIN**

Ideal for 4x4s, SUVs, caravans and motorhomes.

Inflates 4x4 tyre in 6 minutes and a car tyre in just 2.5 minutes. Simple set up - just rotate dial to set pressure. Back lit digital display makes it easy to set your desire pressure. Automatically stops when the pressure is reached. LED light built in for ease of use at night. Long cables to reach tyres all around the vehicle. Comes with three piece adaptor kit.

**Specifications**

**Product Dimensions (mm):** H168 x W238 x D123  
**Weight (kg):** 2.026  
**Voltage:** 12V DC  
**Watts:** 180W

## TRAILER EQUIPMENT

**500-06302****SPHERE RAPID FLOW  
TYRE INFLATOR 33L/MIN**

Ideal for 4x4s, SUVs, caravans and motorhomes.

Powerful inflation from a 12V socket - 4x4 tyre inflates in 5 mins, car tyre in 2 mins. Back lit digital display makes it easy to set your desire pressure Automatically stops when the pressure is reached LED light built in for ease of use at night Long cables to reach tyres all around the vehicle. Comes with three piece adaptor kit.

**Specifications**

Product Dimensions (mm): H172 x W260 x D128

Weight (kg): 2.696

Voltage: 12V DC

Watts: 180W

**500-06512****NARVA TRAILER PLUG 7  
PIN LARGE ROUND PLASTIC  
BLISTER PACK****500-06514****NARVA TRAILER PLUG 7 PIN LARGE ROUND PLASTIC  
BLISTER PACK****TRAILER PLUGS****500-06306****NARVA H/DTY 5MT  
ACCESSORY EXTENSION  
LEAD****500-06520****NARVA TRAILER PLUG 7PIN  
FLAT BLISTER PACK****500-06500****NARVA TRAILER PLUG 6  
PIN SMALL ROUND PLASTIC  
BLISTER****500-06522****NARVA CAR SOCKET 7 PIN  
FLAT BLISTER PACK****500-06504****NARVA TRAILER PLUG 7  
PIN SMALL ROUND PLASTIC  
BLISTER PACK****500-06532****NARVA TRAILER ADAPTOR  
7 PIN ROUND CAR TO 6 PIN  
ROUND VAN****500-06506****NARVA CAR SOCKET 7 PIN SMALL ROUND PLASTIC  
BLISTER PACK****500-06536****NARVA TRAILER ADAPTOR  
7 PIN ROUND CAR TO 7 PIN  
FLAT VAN**

## TRAILER EQUIPMENT

500-06540

**NARVA TRAILER ADAPTOR  
7 PIN FLAT CAR TO 7 PIN  
ROUND VAN**



500-02600

**NARVA 12 PIN FLAT  
TRAILER PLUG**

7 pole amp rating per pole  
15A at 12V  
5 pole amp rating per pole  
35A at 12V



500-06544

**NARVA TRAILER ADAPTOR 7  
PIN LARGE ROUND CAR TO 7  
PIN FLAT VAN**



500-02602

**NARVA 12 PIN TRAILER SOCKET**

7 pole amp rating per pole 15A at 12V  
5 pole amp rating per pole 35A at 12V



500-06548

**NARVA TRAILER ADAPTOR  
7 PIN FLAT CAR TO 7 PIN  
LARGE ROUND VAN**



500-90004N

**ELECTREX 10M CARAVAN  
SUPPLY LEAD STANDARD**

A supply lead for caravans and motorhomes allowing for connection to camp site power supply posts. Comes complete with a plug, connector and a strain relief dog bone.



**ONLY**  
AVAILABLE IN  
NEW ZEALAND

500-06552

**NARVA TRAILER ADAPTOR 7  
PIN LARGE ROUND CAR TO 7  
PIN SMALL ROUND VAN**



500-90006N

**ELECTREX 10M ANGLED  
CARAVAN SUPPLY LEAD**

A supply lead for caravans and motorhomes allowing for connection to camp site power supply posts. Comes complete with a plug, angled connector and a strain relief dog bone.



**ONLY**  
AVAILABLE IN  
NEW ZEALAND

500-06560

**NARVA TRAILER ADAPTOR 7  
PIN SMALL ROUND CAR TO 7  
PIN LARGE RND VAN**



500-90008N

**ELECTREX CARAVAN  
SUPPLY ADAPTOR**

Allows you to provide power to your caravan or motorhome from a domestic power point. The Caravan Supply Adaptor has a 10A MCB to protect the domestic power supply.



**ONLY**  
AVAILABLE IN  
NEW ZEALAND

500-06562

**NARVA HEAVY DUTY  
50AMP CONNECTOR  
HOUSING**

Has an impact resistant polycarbonate housing and silver plated solid copper terminals.



## Specifications

Amperage rating: 50A

Suits cable size: 8mm<sup>2</sup>

Operating temperature: -20°C to 105°C

500-90010N

**ELECTREX 10M CARAVAN SUPPLY  
LEAD WITH C/W  
J/BOX**

Power cord locker with a 10m fixed supply lead.



**ONLY**  
AVAILABLE IN  
NEW ZEALAND

## CABLE TIES

**500-90012N  
ELECTREX EXTERNAL INLET  
PLUG**

A 240V blue surface mounting IP67 inlet. Rating: 16A

**Specifications**

Pins: 2P + E

Earth Position: 6H

**500-90014N  
ELECTREX PLUG-FEMALE**

Optima Series IP67 connector. It is a blue 240V connector rated at 16A.

**Specifications**

Pins: 2P + E

Earth Position: 6H Ins. Perforation

**500-90016N  
ELECTREX PLUG-MALE**

An IP44, blue, 240V plug, rated at 16A.

**Specifications**

Pins: 2P + E

Earth Position: 6H Ins. Perforation

**500-90022N  
ELECTREX FEMALE PLUG 90  
DEGREE (FOR FLUSH MOUNT  
INLET)**

Optima Series IP44 connector. It is a blue 240V connector rated at 16A.

**Specifications**

Pins: 2P + E

Earth Position: 6H (Right Angle)

**COAST TO COAST CABLE TIES**

High quality self-locking nylon cable ties available in black or white in 11 different sizes.

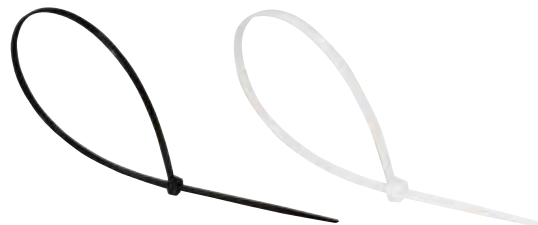

Part Number	Description
500-08000	2.5x150mm Cable Tie Black 100pcs/Bag
500-08004	2.5x200mm Cable Tie Black 100pcs/Bag
500-08008	3.6x150mm Cable Tie Black 100pcs/Bag
500-08012	3.6x200mm Cable Tie Black 100pcs/Bag
500-08016	3.6x250mm Cable Tie Black 100pcs/Bag
500-08020	3.6x300mm Cable Tie Black 100pcs/Bag
500-08024	4.8x200mm Cable Tie Black 100pcs/Bag
500-08028	4.8x250mm Cable Tie Black 100pcs/Bag
500-08032	4.8x300mm Cable Tie Black 100pcs/Bag
500-08036	4.8x360mm Cable Tie Black 100pcs/Bag
500-08002	2.5x150mm Cable Tie White 100pcs/Bag
500-08006	2.5x200mm Cable Tie White 100pcs/Bag
500-08010	3.6x150mm Cable Tie White 100pcs/Bag
500-08014	3.6x200mm Cable Tie White 100pcs/Bag
500-08018	3.6x250mm Cable Tie White 100pcs/Bag
500-08022	3.6x300mm Cable Tie White 100pcs/Bag
500-08026	4.8x200mm Cable Tie White 100pcs/Bag
500-08030	4.8x250mm Cable Tie White 100pcs/Bag
500-08034	4.8x300mm Cable Tie White 100pcs/Bag
500-08038	4.8x360mm Cable Tie White 100pcs/Bag
500-08042	7.6x400mm Cable Tie White 100pcs/Bag
500-08040	7.6x400mm Cable Tie Black 100pcs/Bag

## CAFRAMO FANS



Coast to Coast's range of high quality Caframo fans are researched, designed, developed and manufactured in Canada for the world.

Caframo fans are constructed with the highest quality and greatest care to deliver high-end, unique products boasting features to increase your comfort. All of the fans can be either surface or flush mounted and are available in black or white.

## SIROCCO II

The all new Sirocco II fan features a unique gimballed design that allows 360° airflow with versatile 12/24 Volt auto-sensing capability. The improved control layout, increased timer settings and quieter operation make the Sirocco II the perfect choice for caravanning in comfort.

## Specifications

Colours: Black and White

Product Size (mm): 90(L) x 241(W) x 305(H)

Product Weight: 1.2kg

## 500-10002

**CAFRAMO SIROCCO II 12/24V BLACK 7" GIMBAL FAN WITH 3 SPEED**



## 500-10000

**CAFRAMO SIROCCO II 12/24V WHITE 7" GIMBAL FAN WITH 3 SPEED**





## CAFRAMO FANS

## BORA

The quietest and most powerful fan in its class! The model 748 Bora 12 Volt fan is designed to deliver the features needed to solve any airflow challenge. The Bora features a long-life motor with center push control, grills on front and back and built-in handle for easy up/ down or side-to-side positioning.

**Specifications**

Colours: Black and White

Product Size (mm): 90(L) x 165(W) x 241(H)

Product Weight: 0.7kg

**500-10004**

**CAFRAMO BORA 12V WHITE 6" FAN WITH 3 SPEED**

**500-10006**

**CAFRAMO BORA 12V BLACK 6" FAN WITH 3 SPEED**



## MAESTRO

Building on the popularity of the original Bora™ fans, the Maestro™ boasts an improved design along with a bright LED for use at night. Equipped for wall mounting, its convenient wired remote pendant control can be located up to six feet away from the fan.

**Specifications**

Colours: Black and White

Product Size (mm): 97(L) x 165(W) x 241(H)

Product Weight: 0.7kg

**500-10008**

**CAFRAMO MAESTRO 12V WHITE 6" VARIABLE SPEED FAN WITH LIGHT AND WIRED CONTROL**

**500-10010**

**CAFRAMO MAESTRO 12V BLACK 6" VARIABLE SPEED FAN WITH LIGHT AND WIRED CONTROL**



## BRIGGS &amp; STRATTON INVERTER GENERATORS

## 500-30650

**P2400 BRIGGS & STRATTON 2400-WATT INVERTER GENERATOR**

Enjoy the little conveniences of home anywhere. Quietly. Because of the Quiet Power Technology®, our inverter generators are quieter than traditional camping generators. This P2400 PowerSmart Series™ generator is also safe for sensitive equipment, like your smartphone, laptop, TV and game systems. The handy portable generator can supply your equipment with power for 8 hours straight (at 25% load). It delivers 2400 starting watts and 1800 running watts. This P2400 features 2x 230V household sockets, one 12V DC charging outlet and two 5V USB ports. Do you need more power? You can link two inverter generators with the optional connector kit.

Briggs & Stratton petrol inverter generators are compact and easy to manoeuvre. While providing the power you need. These inverter generators are low maintenance, and ready for all your outdoor leisure needs.

**Features**

- > Safe for Sensitive Electronics
- > Designed for Camping
- > Quiet Power Technology
- > Quiet Portable Generator
- > Multiple Outlets for Your Power Needs
- > Easy Mobility
- > Parallel Connector Port
- > CO Guard™ Carbon Monoxide Shutdown

**Specifications**

**Starting Watts:** 2400  
**Running Watts:** 1800  
**Voltage (V):** 230  
**Frequency (Hz):** 50  
**Noise Level (dB(A)):** 58  
**Run Time:** 8h  
**Outlets:** 2x 230V / 16 Amp, 1x 12V / 5 Amp DC Charging outlet, 2x USB  
**Starter:** Recoil  
**Engine Configuration:** 4-stroke OHV  
**Displacement (cc):** 79  
**Fuel Tank Capacity (l):** 3,8  
**Automatic Low Oil Shut Down:** Yes  
**Circuit Breaker:** Yes  
**Transport Handle:** Twin carry handle, optional wheel kit  
**Weight (kg):** 22,7  
**Length (cm):** 51  
**Width (cm):** 31  
**Height (cm):** 44



## 500-30651

**P3400 BRIGGS & STRATTON 3400-WATT INVERTER GENERATOR**

Briggs & Stratton petrol inverter generators are compact and easy to manoeuvre. While providing the power you need. These inverter generators are low maintenance, and ready for all your outdoor leisure needs.

- > CO Guard™ - Shuts down your generator when harmful levels of carbon monoxide are detected
- > QPT™ Quiet Power Technology - Automatically adjusts the engine speed further reducing noise and fuel consumption
- > Easy Portability with telescopic handle and integrated wheels
- > The PowerSmart Series Inverter Generators deliver 'pure sine Waves' at 3400 watts peak and 2800 watts continuous making it
- > Ideal for sensitive electronic equipment
- > StatStation™ Digital Display - Displays power usage, total unit lifetime hours, and maintenance reminders.
- > Up to 8 hours run time @ 25% load

**Specifications**

**Number of Outlets:** 3  
**Engine:** Briggs & Stratton® OHV  
**Displacement:** 171cc  
**Amperage:** 15A  
**Voltage:** 230V AC  
**Auto Idle:** Yes  
 Auto Voltage Regulation Inverter  
**Fuel Tank Capacity (L):** 5.7  
**Muler:** Yes - Spark Arrestor Type  
**Weight (Kg):** 38.6  
**Low Oil Protection System:** Yes  
**RCD:** No  
**Dimensions L x W x H (cm):** 66 x 35.2 x 51.7

## 500-30652

**P4500 BRIGGS & STRATTON 4500-WATT INVERTER GENERATOR**

Enjoy the little conveniences of home anywhere. Because of the Quiet Power Technology®, our inverter generators are quieter than traditional camping generators. This P4500 PowerSmart Series™ generator is also safe for sensitive equipment, like your smartphone, laptop, TV and game systems. This portable generator can supply your equipment with power for 16 hours straight (at 25% load). It delivers 4500 starting watts and 3700 running watts.

**Specifications**

**Starting Watts:** 4500  
**Running Watts:** 3700  
**Voltage (V):** 230  
**Frequency (Hz):** 50  
**Noise Level (dB(A)):** 61  
**Run Time:** 16h  
**Outlets:** 2x 230V / 16 Amp, 1x 12V / 5 Amp DC Charging outlet, 2x USB  
**Starter:** Electric/Recoil  
**Engine Configuration:** 4-stroke OHV  
**Displacement (cc):** 224  
**Fuel Tank Capacity (l):** 13  
**Automatic Low Oil Shut Down:** Yes  
**Circuit Breaker:** Yes  
**Transport Handle:** Telescopic handle, side handles, integrated wheels  
**Weight (kg):** 52,1  
**Length (cm):** 62  
**Width (cm):** 44  
**Height (cm):** 52

## GAS EQUIPMENT

## GAS ACRONYMS

BSP	British Standard Pipe
BSPT	British Standard Pipe Tapered
NPT	National Pipe Thread
POL	Prest-O-Lite
SAE	Society of Automotive Engineers
M	This indicates that it is a male fitting
F	This indicates that it is a female fitting

For your own safety all gas fittings and equipment should be installed and checked by a qualified person.

## 550-00100

## YELLOW GAS SEAL TAPE

Has a heat resistance of +200°C & a cold resistance of up to -20°C. Pressure resistant up to 2600kPa & is made of sintered PTFE (Poly Tetra Fluoro Ethylene).



## Specifications

Dimensions: 12mm (W) x 10m (L)

## LCI LIPPERT BOTTLECHECK BLUETOOTH GAS GAUGE

Easily check gas bottle levels using BottleCheck Bluetooth sensor and smartphone application. BottleCheck gives you peace of mind, measuring the LPG level and alerting you before you run out. BottleCheck can be used on tanks in RVs, caravans, heaters, BBQ grills.

Keep on top of your gas bottle level using the LCI BottleCheck Bluetooth Sensor! Download the FREE app and track the gas level right from your smartphone.

BottleCheck sensors are magnetically attached to the bottom of the gas bottle. The sensors periodically measure propane levels and wirelessly send the fill level to the BottleCheck app.

Available in single or double sensor kits.

## Specifications

Sensor Siz.: 72mm Diameter 8mm High

Weight: 30 Grams

Bluetooth Range: 50 Ft

Measures: LPG only

Temp Range: -30°C to + 55°C

IP Rating: IP64

## 550-00020

## LCI LIPPERT BOTTLECHECK BLUETOOTH GAS GAUGE - SINGLE SENSOR KIT



## 550-00022

## LCI LIPPERT BOTTLECHECK BLUETOOTH GAS GAUGE - TWIN SENSOR KIT



## LOXEAL 58-11 HIGH PRESSURE THREAD SEALANTS

Ideal for sealing threaded joints against gas, water, oils and other chemicals.

- > Anaerobic adhesive for the sealing of threaded metal to metal joints
- > Seals against gas, water, LPG, hydrocarbons, oils and other chemicals
- > High viscosity - won't run on thread
- > Sealing unaffected by shock/vibration within temperature range: -55°C to +150°C
- > Rapid cure time - functional in less than 3 hours
- > Water-safe & AGA-approved

## 550-00104

## 100ML TUBE



## 550-00106

## 250ML TUBE



## REGULATORS

## 550-00298

## GAS REGULATOR 2 STAGE (LOW PRESSURE)

Approved for use in portable applications such as outdoor cooking appliances that use a low pressure. Featuring a zinc construction, high and low 1/8" NPT pressure tap ports and a drip lip vent. Meets the RVIA, UL and NFPA test requirements.



## Specifications

Capacity: 190,000BTU/hr (at 30 PSI inlet)

Inlet: 1/4" FNPT

Outlet: 3/8" FNP

## 550-00302

## LPG (SINGLE STAGE) GAS REGULATOR

3.5kg/hr adjustable soft nose BBQ regulator 3/8" BSPF outlet.



## GAS EQUIPMENT

**550-00304**  
**GAS CYLINDER 2 STAGE**  
**ADJ.160MJ REGULATOR**



**550-00306**  
**GAS CYLINDER 2 STAGE**  
**ADJ.160MJ REGULATOR KIT**  
**-DUAL**

Adjustable Regulator



**550-00310**  
**GAS REGULATOR 160MJ**  
**WITH BRACKET &**  
**PIGTAIL ADAPTOR**



**550-00312**  
**GAS REGULATOR 160MJ**  
**MANUAL CHANGE OVER &**  
**BRACKET**



**550-00314**  
**SINGLE GAS CYLINDER**  
**REGULATOR KIT**

Single regulator with elbow, metal bracket, 3/8" adaptor with T point & flexible hose with hand wheel. Comes assembled.



**550-00316**  
**DUAL GAS CYLINDER**  
**REGULATOR KIT**

Manual change over regulator, metal bracket, 3/8" adaptor with T point & 2 flexible hoses with hand wheel. Comes assembled.



**550-00318**  
**MARSHALL 2 STAGE HIGH-**  
**CAPACITY LPG REGULATOR 290MJ**  
**1/4"FNPT X 3/8"FNPT**

High Capacity Compact Integral Two Stage Regulator is approved for use in nearly all portable applications and light duty domestic home installations. Ideally suited for RV, outdoor appliances, cabins, seasonal homes, gas fire places, water heaters, ranges or the other moderate to low demand domestic home installations.



## PIGTAIL

**550-00320**  
**COPPER PIGTAIL**  
**POL X 1/4"**  
**INVERTED FLARE (750MM**  
**LONG)**



**550-00330**  
**COPPER PIGTAIL**  
**POL X 1/4"**  
**INVERTED FLARE (450MM)**



## GAS HOSES

**550-00332**  
**8MM S/S FLEXIBLE HOSE**  
**900MM FOR SINGLE BOTTLE**  
**KITS**



**550-00333**  
**8MM S/S FLEXIBLE HOSE**  
**600MM FOR SINGLE BOTTLE**  
**KITS**

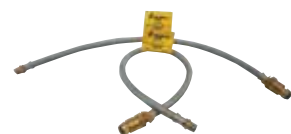

**550-00334**  
**8MM S/S FLEXIBLE HOSE**  
**450MM**

For single bottle kits (avalanche valve x 1/4" BSPM male)



**550-00336**

**8MM S/S FLEXIBLE HOSE  
450MM**

For double bottle kits (avalanche valve  
x inverted flare)



**550-00349**

**S/S FLEXIBLE HOSE 3000MM**

With Male Bayonet + Handle 3/8 Sae F



**550-00337**

**8MM S/S FLEXIBLE HOSE  
600MM**

For double bottle kits (avalanche valve  
x inverted flare)



**550-00350**

**VALVE & ADAPTER**

Manual changeover valve t/s regulator



**550-00338**

**8MM S/S FLEXIBLE HOSE  
900MM**

For double bottle kits (avalanche  
valve x inverted flare)



**550-00360**

**MOUNTING BRACKET**

A universal regulator bracket (i.e.  
suits single, twin stage regulators)



**550-00340**

**S/S FLEXIBLE HOSE 450MM**

with hand wheel for single bottle kit. (POL x 1/4"  
NPTM)



**550-00370**

**SCREWS FOR MOUNTING BRACKET**



**550-00341**

**S/S FLEXIBLE HOSE 600MM**

with hand wheel for single bottle kit. (POL  
x 1/4" NPTM)



**550-00380**

**INVERTED FLARE STRAIGHT  
MALE UNION ADAPTER**

2 stage gas regulator. (1/4" NPTM  
x 1/4" female inverted flare)



**550-00344**

**S/S FLEXIBLE HOSE 450MM**

with hand wheel for double bottle kit  
(POL x 5/16")



**550-00390**

**INVERTED FLARE 90° ELBOW  
MALE UNION ADAPTOR**

2 stage gas regulator. (1/4" MNPT  
x 1/4" female inverted flare)



**550-00345**

**S/S FLEXIBLE HOSE 600MM**

with hand wheel for double bottle kit  
(POL x 5/16")

Class: F, 6mm, 2600Kpa



**550-00500**

**GAS HOSE 3/8" BSPM X  
3/8" SAEM X 300MM**



## GAS EQUIPMENT

**550-00510****GAS HOSE - 6MM PVC,  
5/16" SAE MF  
X 3/8" BSP M, 300MM**

For use with LPG (propane)

**Specifications**

Inlet: 5/16" SAE MF

Outlet: 3/8" BSP M

AGA Approval: 4237

Gas Hose Class (Max Working Pressure/Working Temp): C (2600kPa/-200C to +650C)

Hose Diameter: 6mm

**550-00550****GAS HOSE 3/8" BSPM X  
1/4" BSPF X 600MM****550-00560****GAS HOSE 3/8" BSPM X 1/4"  
BSPF X 900MM****550-00570****GAS HOSE 3/8" BSPM X 1/4"  
BSPF X 1200MM****550-00600****SAE MALE X BSP FEMALE UNION  
5/16" X 1/4"****550-00602****SAE MALE X BSP FEMALE UNION  
5/16" X 3/8"****550-00604****SAE MALE X BSP FEMALE  
UNION 3/8" X 1/4"****550-00606****SAE MALE X BSP FEMALE  
UNION 3/8" X 3/8"****550-00608****SAE MALE X BSP FEMALE UNION  
3/8" X 1/2"****550-00610****SAE MALE X SAE MALE DOUBLE  
UNION  
5/16" X 5/16"****550-00612****SAE MALE X SAE MALE DOUBLE  
UNION 3/8" X 3/8"****550-00614****REDUCING UNION  
3/8" X 5/16"****550-00616****SAE MALE X SAE MALE DOUBLE  
ELBOW 5/16" X 5/16"****550-00618****SAE ALL MALE 3-WAY TEE  
CONNECTOR 5/16"****550-00620****SAE ALL MALE 3-WAY TEE  
CONNECTOR 3/8"****550-00622****BSP MALE TAPERED X BSP FEMALE  
ELBOW 1/4" X 1/4"**

# GAS EQUIPMENT

**550-00624**  
SAE FLARE NUT 5/16"



**550-00640**  
SAE MALE X BSP TAPERED  
MALE UNION 3/8" X 3/8"



**550-00626**  
SAE FLARE NUT 3/8"



**550-00642**  
SAE MALE X BSP MALE  
TAPERED ELBOW 5/16" X 1/4"



**550-00628**  
SAE REDUCING FLARE NUT  
3/8" X 5/16"



**550-00644**  
SAE MALE X BSP MALE TAPERED  
ELBOW 5/16" X 3/8"



**550-00630**  
SAE 45° FLARE BRASS FITTING,  
MALE UNION, 5/16 TUBE, 1/8 BSPT



**550-00646**  
BALL VALVE BSP FEMALE  
X BSP  
FEMALE 1/4" X 1/4"



**550-00632**  
SAE MALE X BSP TAPERED MALE  
UNION 5/16" X 1/4"



**550-00648**  
FLARED BALL VALVE  
5/16" X 5/16" SAE



**550-00634**  
SAE 450 FLARE BRASS  
FITTING, MALE UNION, 5/16  
TUBE, 3/8 BSPT



**550-00650**  
FLARED BALL VALVE 3/8" X 3/8"  
BSP



**550-00636**  
SAE MALE X BSP TAPERED MALE  
UNION 3/8" X 1/8"



**550-00652**  
FLARED BALL VALVE  
1/2" X 1/2" BSP



**550-00638**  
SAE MALE X BSP TAPERED  
MALE UNION 3/8" X 1/4"



## GAS EQUIPMENT

**550-00700****GAS TESTING NIPPLE**

3/8" flare x 3/8" male

**550-00710****GAS FLOOR SOCKET FEMALE CHROME**

Manufactured from high quality brass and stainless steel. The unit is corrosion resistant and is approved to the AGA requirements. Chrome plated, with the inlet being a 1/2" BSP threaded connection. (7Kpa)

**550-00711****DUST CAP T/S CHROME PLATED BAYONETS**

Dust cover to suit bayonet outlet.

**550-00712****MALE BAYONET SOCKET 1/4" BSP**

Comes with a 1/4" BSP male nipple for screw on attachment to a standard gas hose with compatible female union fittings.



## GAS CYLINDERS

**550-01002****MANCHESTER 9KG GRADE 2 GAS CYLINDER WITH LCC 27 VALVE NO GAUGE****550-01002****MANCHESTER 9KG GRADE 2 GAS CYLINDER WITH LCC 27 VALVE NO GAUGE****550-01302****STRAP RATCHET T/S GAS BOTTLE**

Ratchet strap to suit gas bottles.



## CRADLES

**550-01052****CRADLE T/S 9KG (GALVANISED)**

With a quick release mechanism.

**550-01062****CRADLE T/S 4KG (GALVANISED)**

With a quick release mechanism.

**550-02010****12V GAS DETECTOR**

Can be installed in homes, motor homes, caravans and the like. It detects a gas leakage and triggers the alarm when the gas level reaches 10% of the LEL (Lowest Explosion Limit) in the air. 120H x 80W x 40D (mm)

**550-01300****GAS BOTTLE SLIDE (WITH THUMB LOCKS)**

Made from mild steel, this slide holds x2 9kg gas bottles.

**Specifications**

Weight: 5.2kg

Dimensions: 656 x 280 x 285 (mm)







# SECTION 5

## CARAVAN HARDWARE

(Product Group - 600)

Coast Access Doors	202 - 204
Grab Handles and Cabin Hooks	205 - 206
Thetford Service Doors	206 - 207
Rosettes, Nickels and Door Locks	207 - 209
Valterra Access Hatches	209
Window Parts	209 - 210
DGN Hinges	210
Caravan Cleaners, Touch Up Paint and Sealers	211 - 215

---

## HATCHES & VENTS

(Product Group - 650)

Elixir Mini Vent	216
Ventline Vents and Spares	216 - 217
Unimaxx Replacement Vent Lids	216
Four Seasons Hatch and Spares	217 - 218
Fantastic Vents and Spares	218
Dust Reduction System	218
Fiamma Hatches, Vents and Hatch Spares	219 - 220
MaxxAir Ventilation	221
Skymaxx Ventilation	222 - 223
Exterior, Rotary and Scupper Vents	223 - 224



## COAST DOORS

Utilise the cavities in your RV body to create much needed storage space and use the Coast Doors to access them. Available in ten handy sizes, the Coast Doors are available in black and white. Installation has been streamlined - screw holes are pre-drilled and they are supplied as a complete door, meaning there is no need to infill. It features an effective door seal and comes with keys to lock and reopen.

**600-00000**  
**COAST DOOR 1**

Has one centre lock and one set of keys. (M500-100)

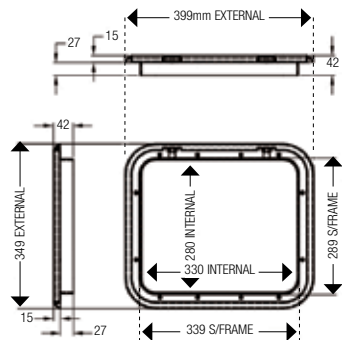
**600-00002**  
**COAST DOOR 2**

Has two locks and two sets of keys. (M500-110)

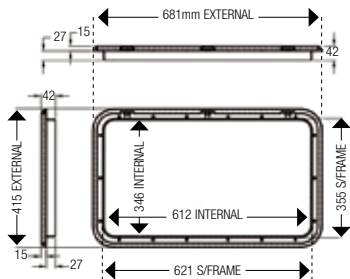
**600-00004**  
**COAST DOOR 3**

Has two locks and two sets of keys. (M500-120)

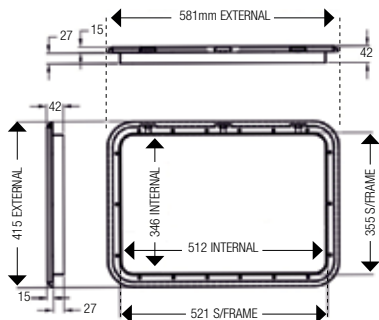
**600-00006**  
**COAST DOOR 4**

Has two locks and two sets of keys. (M500-130)

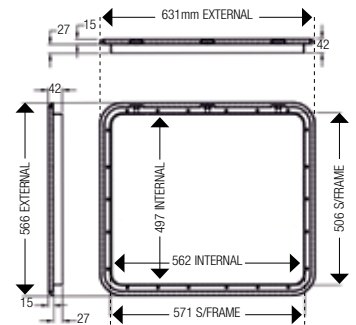
**600-00008**  
**COAST DOOR 5**

Has two locks and two sets of keys. (M500-140)

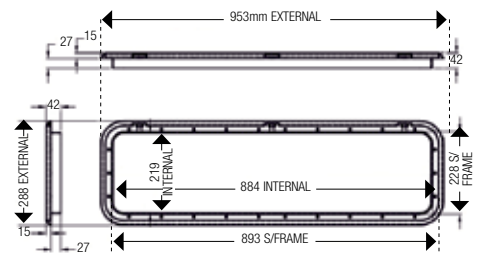
**600-00010**  
**COAST DOOR 6**

Has two locks and two sets of keys. (M500-150)

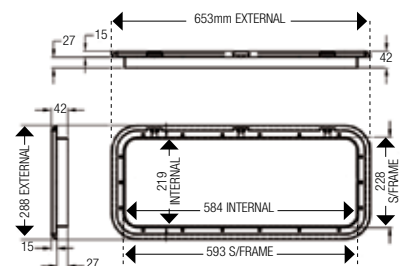
**600-00012**  
**COAST DOOR 7**

Suitable for installation on the 'entry' side of the caravan.

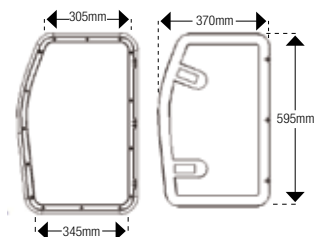

## COAST DOORS

**600-00014****COAST DOOR 8**

Suitable for installation on the 'closed' side of the caravan.

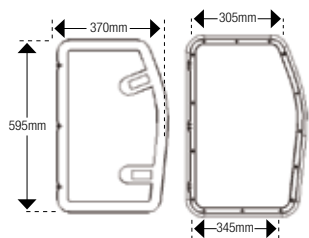
**600-00022****COAST DOOR 2 (BLACK)**

Has two locks and two sets of keys. (M500-210)

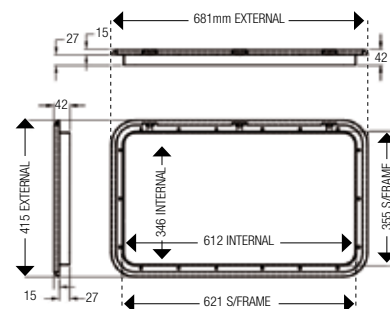
**600-00016****COAST DOOR 9**

Has two locks and two sets of keys.

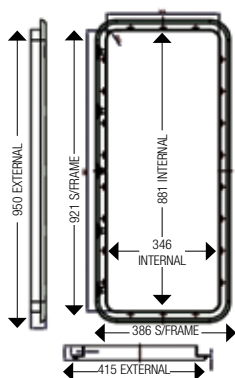
**600-00024****COAST DOOR 3 (BLACK)**

Has two locks and two sets of keys. (M500-220)

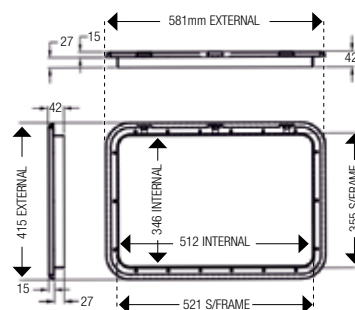
**600-00018****COAST DOOR 10 TUNNEL BOOT DOOR**

Has two locks and two sets of keys.

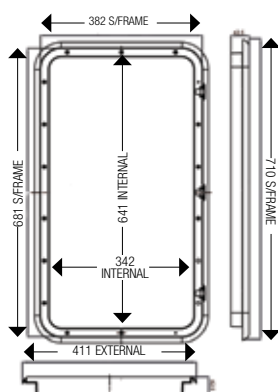
**600-00026****COAST DOOR 4 (BLACK)**

Has two locks and two sets of keys. (M500-230)

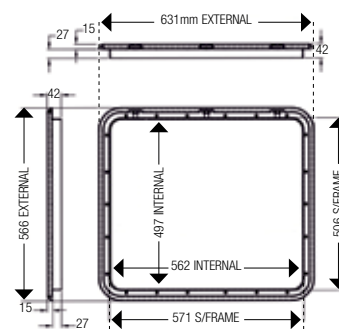
**600-00020****COAST DOOR 1 (BLACK)**

Has one centre lock and one set of keys. (M500-200)

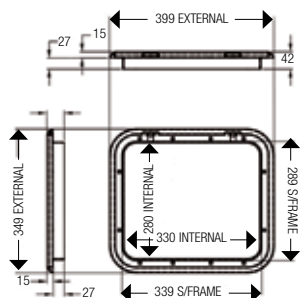
**600-00028****COAST DOOR 5 (BLACK)**

Has two locks and two sets of keys. (M500-240)

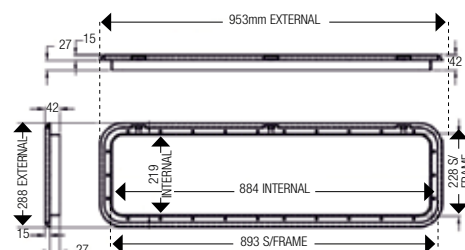

**600-00030**

**COAST DOOR 6 (BLACK)**

Has two locks and two sets of keys. (M500-250)

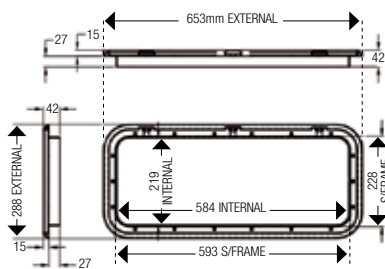

**600-00032**

**COAST DOOR 7 (BLACK)**

Suitable for installation on the 'closed' side of the caravan.

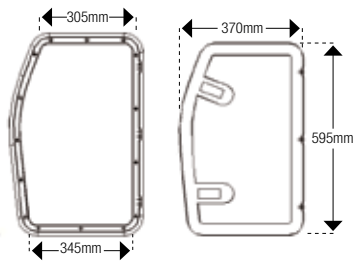

**600-00034**

**COAST DOOR 8 (BLACK)**

Suitable for installation on the 'entry' side of the caravan.

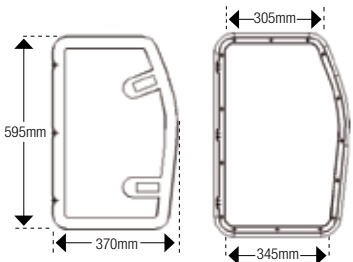

**600-00036**

**COAST DOOR 9 (BLACK)**

Has two locks and two sets of keys.

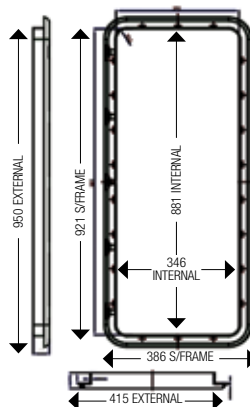

**600-00038**

**COAST DOOR 10 (BLACK) TUNNEL BOOT DOOR**

Has two locks and two sets of keys.

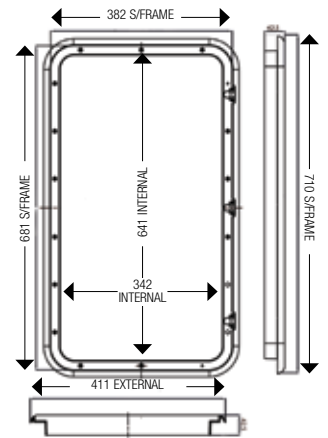

**600-00357**

**WHITE DOOR LOCK**

Sold as a single lock with a set of keys. Suitable for use on Coast Access Doors



**600-00359**

**CHROME DOOR LOCK**

Sold as a single lock with a set of keys. Suitable for use on Coast Access Doors



## GRAB HANDLES

**600-00120**

**WHITE CARAVAN PLASTIC GRAB HANDLE - MODEL 86**

This is a sturdy plastic handle designed to act as a convenient grabbing point on corners of RVs.



# COAST GRAB HANDLES

## COAST GRAB HANDLES

Coast Grab Handles are made from lightweight and durable stainless steel and are ideal for both internal and external RV use.

Available in four convenient sizes in both stainless steel or matte black finishes, the range is well suited to accommodate most needs. Each grab handle comes equipped with a fixing kit for secure DIY mounting and features a knurled steel gripping surface for safe and convenient use.

They are a perfect fit for the entry way to your RV or even as a front or rear gripping point for manually moving a van around.



**600-00170**  
**COAST 350MM STAINLESS STEEL CARAVAN GRAB HANDLE - 32MM (D) 350MM (L)**

**600-00172**  
**COAST 400MM STAINLESS STEEL CARAVAN GRAB HANDLE - 32MM (D) 400MM (L)**

**600-00174**  
**COAST 500MM STAINLESS STEEL CARAVAN GRAB HANDLE - 32MM (D) 500MM (L)**

**600-00176**  
**COAST 600MM STAINLESS STEEL CARAVAN GRAB HANDLE - 32MM (D) 600MM (L)**

**600-00180**  
**COAST 350MM MATT BLACK STAINLESS STEEL CARAVAN GRAB HANDLE - 32MM (D) 350MM (L)**

**600-00182**  
**COAST 400MM MATT BLACK STAINLESS STEEL CARAVAN GRAB HANDLE - 32MM (D) 400MM (L)**

**600-00184**  
**COAST 500MM MATT BLACK STAINLESS STEEL CARAVAN GRAB HANDLE - 32MM (D) 500MM (L)**

**600-00186**  
**COAST 600MM MATT BLACK STAINLESS STEEL CARAVAN GRAB HANDLE - 32MM (D) 600MM (L)**

## PLASTIC GRAB HANDLES

These grab handles are sleek with a robust design. Available in white or black, they are easy to install. It involves a simple process of attaching the handle with four screws. Once done, the screws can then be covered up using the end caps provided.

### Specifications

Dimensions: 170L x 45W (mm)

**600-02000**  
**WHITE PLASTIC GRAB HANDLE**



**600-02010**  
**BLACK PLASTIC GRAB HANDLE**



**600-02030**  
**LED GRAB HANDLE BLACK (12V)**

Add some style to an RV entry with this grab handle. It has a blue glow that can be turned on or off via a red button. It is also simple to attach with two screws and two gaskets.



## THETFORD SERVICE DOORS

## CABIN HOOKS

**600-00148**  
CHROME CABIN HOOK 75MM



**600-00150**  
CHROME CABIN HOOK 100MM



**600-00152**  
CHROME CABIN HOOK 150MM



**600-00154**  
CHROME CABIN HOOK 200MM



**600-00160**  
EYE TO SUIT CHROME CABIN HOOK



**600-00162**  
RETAINER FOR CABIN HOOK



## THETFORD SERVICE DOORS

Create easy access to areas of your caravan or motor home. These service doors are made from high grade and lightweight plastics making them durable and are supplied with a step-by-step guide (including a template) for easy installation.

**850-01600**  
SERVICE DOOR TO SUIT THETFORD CASSETTE - WHITE

## Specifications

Total Dimensions: 385H x 340W (mm)  
Door Opening Dimensions: 330H x 280W (mm)

**NZ #850-91000N**



**850-01601**  
SERVICE DOOR (#3) TO SUIT THETFORD CASSETTE - BLACK

## Specifications

Total Dimensions: 385H x 340W (mm)  
Door Opening Dimensions: 330H x 280W (mm)



**600-00200**  
THETFORD SERVICE DOOR #4

Great for gas cylinders and water tanks. Has two push button latches with locks and is available in white.

## Specifications

Total dimensions: 700H x 395W (mm)  
Door opening dimensions: 630H x 330W (mm)

**NZ #850-91010N**



**600-00201**  
THETFORD SERVICE DOOR #4 (BLACK)

Great for gas cylinders and bbq's. Has two pushbutton latches with locks and is watertight and UV resistant.

## Specifications

Total dimensions: 700H x 395W (mm)  
Door opening dimensions: 630H x 330W (mm)



**600-00210**  
THETFORD SERVICE DOOR #5

Great for water tanks and as a general luggage door. Has two push button latches with locks and is available in white.

## Specifications

Total dimensions: 785H x 340W (mm)  
Door opening dimensions: 730H x 280W (mm)

**NZ #850-91020N**



**600-00211**  
THETFORD SERVICE DOOR #5 (BLACK)

Great for water tanks and as a general luggage door. Has two pushbutton latches with locks and is watertight and UV resistant.

## Specifications

Total dimensions: 785H x 340W (mm)  
Door opening dimensions: 730H x 280W (mm)





## 600-00220

### THETFORD SERVICE DOOR #6

Great as a luggage door or for larger objects. Has three push button latches with locks and is available in white.



#### Specifications

Total dimensions: 1038H x 465W (mm)

Door opening dimensions: 980H x 400W (mm)

**NZ #850-91030N**

## 600-00221

### THETFORD SERVICE DOOR #6 (BLACK)

Great for large luggage or bulkier items. Has three pushbutton latches with locks and is watertight and UV resistant.



#### Specifications

Total dimensions: 1038H x 465W (mm)

Door opening dimensions: 980H x 400W (mm)

## 600-00299

### THETFORD HINGE PIN FOR SERVICE DOORS 3, 4 AND 5



## 600-00231

### THETFORD SERVICE DOOR #7

Service Door 7 is perfect for access to a storage area for large objects, like the camping table and chairs or to use as general luggage door.



#### Specifications

Total dimensions: 1108 x 346 (mm)

Door opening dimensions: 1051 x 282 (mm)

## 600-00233

### THETFORD SERVICE DOOR #7 (BLACK)

Service Door 7 is perfect for access to a storage area for large objects, like the camping table and chairs or to use as general luggage door.



#### Specifications

Total dimensions: 1108 x 346 (mm)

Door opening dimensions: 1051 x 282 (mm)

## 600-00450

### WHITE BAGGAGE DOOR CATCH

ABS plastic catches keep baggage compartments open while loading and unloading for easy access. Easily mounts directly on RV. (Pack of 2)



## 600-00510

### PUSH BUTTON CATCH MINI

Has a 20mm ring. Please order 600-00512 and 600-00522 and 600-00524/600-00516 to make a complete kit.



## 600-00512

### STRIKER PLATE NICKEL ANGLED

Please order 600-00510 and 600-00522 and 600-00524/600-00516 to make complete kit.



## 600-00520

### PUSH BUTTON LOCK (BROWN)

A larger version of 600-00510.



#### Specifications

Dimensions: 35L x 48H x 20D (mm) and has a 25mm ring.

## 600-00522

### PUSH CATCH ROSETTE ONLY NICKEL 19MM

Please order 600-00510, 600-00512 and 600-00524 to make a complete kit.



## 600-00524

### PUSH BUTTON CATCH KNOB ONLY NICKEL 19MM

Please order 600-00510, 600-00512 and 600-00524 to make a complete kit.



## 600-00526

### PUSH CATCH ROSETTE ONLY GOLD 19MM



## 600-00528

### PUSH BUTTON CATCH KNOB ONLY GOLD 19MM



**600-00530**  
**PUSH BUTTON KNOB ONLY**  
**NICKEL 23MM**

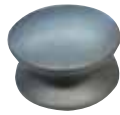

**600-00532**  
**PUSH BUTTON ROSETTE ONLY NICKEL**  
**23MM**



### MILENCO COLUMBIA DOORS

Feel safer on your next adventure with the Columbia door, an attractive caravan entrance door built with safety in mind.

**650-00654**  
**MILENCO MEDIUM COLUMBIA DOOR**  
**- WHITE/BLACK FRAME RH**  
**(1750 X 622MM)**



**650-00655**  
**MILENCO MEDIUM COLUMBIA DOOR**  
**- BLACK/BLACK FRAME RH**  
**(1750 X 622MM)**



**650-00656**  
**MILENCO MEDIUM COLUMBIA DOOR**  
**- WHITE/BLACK FRAME LH (1750 X 622MM)**

**650-00657**  
**MILENCO MEDIUM COLUMBIA DOOR**  
**- BLACK/BLACK FRAME LH (1750 X 622MM)**

**650-00658**  
**MILENCO LARGE COLUMBIA DOOR**  
**- BLACK/BLACK FRAME RH (1850 X 622MM)**

**650-00659**  
**MILENCO LARGE COLUMBIA DOOR**  
**- BLACK/BLACK FRAME LH (1850 X 622MM)**

### CAMEC DOOR LOCKS

**600-00690**  
**MAIN DOOR LOCK**  
**(LEFT HAND)**

Suitable for use with Camec's 3-point, left hinged main door.



**600-00692**  
**MAIN DOOR LOCK**  
**(RIGHT HAND)**

Suitable for use with Camec's 3-point, right hinged main door.



**600-00694**  
**MAIN DOOR LOCK (INNER**  
**HANDLE KIT)**

Suitable for use with Camec's 3-point door lock, comes with the spindle and screw.



**600-00696**  
**MAIN DOOR LOCK (OUTER**  
**HANDLE KIT)**

Suitable for use with Camec's 3-point door lock, comes with the outer handle and torsion spring.



**600-00699**  
**CAMEC BARREL & KEY T/S**  
**MAIN DOOR LOCK**

Replacement barrel and key to suit Camec three point main door lock.



### PANORAMA DOOR LOCKS

**600-00600**  
**PANORAMA DOOR LOCK**  
**COMPLETE**



**600-00602**  
**PANORAMA DOOR OUTER**  
**LOCK WITH KEYS**



**600-00604**  
**PANORAMA INNER LOCK**  
**ONLY**



**600-00702**  
**VALTERRA 4" ACCESS**  
**HATCH BLACK**



## TRIMATIC DOOR LOCKS

**600-00620**  
**TRIMATIC DOOR LOCK**  
**COMPLETE**



**600-00704**  
**VALTERRA 5" ACCESS HATCH**  
**BLACK**



**600-00622**  
**TRIMATIC DOOR LOCK OUTER LOCK**  
**WITH KEYS**



**600-00706**  
**VALTERRA 5" ACCESS HATCH**  
**BLACK**



**600-00624**  
**TRIMATIC DOOR INNER LOCK**  
**ONLY**



## WIND OUT WINDOW CONTROL BOXES

**600-01100**  
**WOW BOX LARGE R/H**

**Specifications**

Dimensions: 295L x 30W (mm)



**600-01110**  
**WOW BOX LARGE L/H**

**Specifications**

Dimensions: 295L x 30W (mm)



**600-01120**  
**WOW BOX SMALL R/H**

**Specifications**

Dimensions: 190L x 30W (mm)



## VALTERRA ACCESS HATCHES

- > 4" and 5" inner diameter
- > Made of UV resistant ABS material which prevents fading
- > Waterproof seal prevents leakage
- > Replaces existing hatches
- > Hole pattern matches most original hatch rings
- > Provides access to plumbing, electrical, cargo areas and hose compartments
- > Use on your RV, boat, horse trailer and more!

**600-00700**  
**VALTERRA 4" ACCESS HATCH**  
**WHITE**



**600-01130**  
WOW BOX SMALL L/H

**Specifications**

Dimensions: 190L x 30W (mm)



**600-01140**  
WOW LINK BOX



**600-01150**  
WOW WINDER HANDLE



**600-01160**  
WOW CORNER INSERT PLASTIC



**600-01170**  
WOW SLIDE LOCK AND LEVER



**600-01180**  
WOW END PLUG



**PROTECTOR SHADE STAYS**

**600-01500**  
SHADE STAY 100MM



**600-01502**  
SHADE STAY 200MM



**600-01504**  
SHADE STAY 250MM



**DGN HINGES**

**600-03002**  
DGN SHORT HINGE FOR TOP AND BOTTOM CUPBOARD C/W SOFT-CLOSE



- > D.G.N. hinges are tested for more than 80.000 opening and closing operations and are lubricated with silicone for a better protection.
- > Has an integrated Soft Close Mechanism making it very quiet and controlled on closing.

**600-03004**  
DGN HORIZ. MOUNT HINGE FOR TOP CUPBOARD W/UPWARD FLAT/CURVED DOOR NO SOFT-CLOSE



- > New and extremely strong hinge from DGN.
- > Has two integrated springs and is protected by an international patent.
- > Its strength means that the locker door will remain perfectly open for years and years.

**600-03006**  
DGN HORIZ. MOUNT HINGE FOR TOP CUPBOARD W/UPWARD FLAT/CURVED DOOR C/W SOFT-CLOSE



- > Heavy duty caravan and RV door hinge.
- > This new hinge has an integrated Soft Close Mechanism making it very quiet and controlled on closing.

**600-03010**  
DGN VERT. MOUNT HINGE FOR TOP CUPBOARD W/UPWARD FLAT/CURVED DOOR C/W SOFT-CLOSE



- > Features spring force regulation that allows the hinge to be mounted on various sized doors.
- > Open angle regulation means the hinge can be set to open to the desired angle.

## CLEANERS

**600-03500**  
**RV SLIDING**  
**DOOR HARDWARE**  
**KIT T/S UP TO**  
**1.83M & 50KG**



**600-05370**  
**CAMCO RV WATER PROOFER**  
 This RV awning water proofer waterproofs and protects by restoring water-repelling qualities to fabric. It is great for outdoor furniture, pop-up campers, RV covers and tents and lasts through several washings (650ml bottle).



**600-05302**  
**CAMCO PRO-STRENGTH BLACK**  
**STREAK REMOVER**

A specially formulated cleaner and degreaser that is ready to use and powers away stubborn black streaks resulting from window and door sealants, bugs, tar, grease, oil and dirt that have built up over time, helping to restore a like-new appearance. Not for use on rubber or membrane roofs. Comes in a 946ml spray bottle.



**600-05382**  
**CAMCO PRO-STRENGTH**  
**MILDEW STAIN REMOVER**

Safely cleans mildew stains, black streaks, tree sap, tyres, wheel and even grills. It is specially formulated to power away stains caused by mildew in and around your RV. Use it to clean your awning, vinyl cover, chair cushions and many other surfaces. Also great for use on grease, oil and other heavy duty cleaning thanks to its professional strength. Comes in a 946ml spray bottle.



**600-05322**  
**CAMCO PRO-STRENGTH WASH**  
**AND WAX**

A blend of natural waxes and emulsifiers that will clean, shine and protect your RV in one easy application. It does not require any buffing and thanks to 100% Carnauba Wax being used in its formula, it leaves behind a water resistant surface that promotes a beading action. Safe for use on all finishes. Comes in a 946ml spray bottle.



**600-05332**  
**CAMCO PRO-STRENGTH**  
**AWNING CLEANER**

Safely removes mould stains, dirt, tree sap and road grime from your awning. It is specially formulated to clean vinyl, nylon, acrylic and fabric awnings, and is also great for use on tents and pop-up campers. Breathe new life into your awning or tent and help restore a like-new appearance. Comes in a 946ml bottle.



**600-05450**  
**CHAMOIS MEDIUM**  
**430 X 320**



**600-05452**  
**SPONGE LARGE ABSORBENT**  
**CONTOURED**



**600-05456**  
**COAST CLEANING CLOTH PACK**  
**OF 4PCS**

This kit of cleaning cloths gives you all the right tools for the job.



**Kit Contains**

- > **Interior Cloth:** For keeping your dashboard, vents and all hard interior surfaces free of dust and grime.
- > **Glass Cloth:** Quickly remove greasy smears, finger marks and grime from windows, mirrors, chrome or polished surfaces.
- > **Drying Cloth:** A thick microfiber cloth that quickly absorbs water from any surface. Perfect for cleaning the car and wiping away water marks.
- > **Suede Cloth:** High quality, soft and lightweight ideal for cleaning and polishing delicate surfaces.

**600-05500**  
**CAMCO TST PROBE CLEANER**

TST Probe Cleaner is a super concentrated liquid that attacks the residue on probes that causes them to malfunction.



**HYDOSILEX**

**600-05672**  
**HYDOSILEX CAMPER**

HydoSilex Camper is a revolutionary ceramic surface protection with no limits. It is the first DIY ceramic coating designed for RVs that'll give them a hydrophobic, slick and shiny effect to protect it from the elements.



HydoSilex coats virtually any RV surface such as paint, plastics, glass, metals, gelcoat, etc. Camper will directly bond to the surface and create a smooth and shiny top ceramic layer to protect the surface against the sun, rain, dirt, bird droppings, and any other elements that might tarnish your investment! It provides UV protection to all surfaces, blocking the harsh rays of the sun to stop fading. The lotus effect makes liquids and contaminants bead up and simply roll off the surface.

It's completely DIY with no professional application needed! It'll leave your RV looking new without constant washing, waxing, and buffing. The ceramic coating will outlast any wax or other surface protection and cannot be washed off. You can add more layers for a longer and stronger protection. It's the new way to maintain your RV that saves time, money and effort with amazing results.

It's easy to apply in 3 simple steps:

**1. Spray**

HydoSilex Camper is a spray on ceramic coating. No mess or grease on hands or anywhere it's not supposed to be.

**2. Level**

Camper instantly bonds with the surface when it is sprayed on. Just level it after sprayed and the coating stays.

**3. Buff**

Lightly buff the surface and see it transform to a super hydrophobic slick surface that makes your vehicle shine.

**600-05674**  
**HYDOSILEX OFFROAD**

The easiest, most effective ceramic coating ever to be applied to the off-road sector! HydroSilex OffRoad can be applied to every exterior surface and will enhance the surface's original shine, protect from the harsh off-road elements as easy as spray and wipe.



This revolutionary DIY ceramic surface protection is specially designed for the off-road environment. Once applied, it gives your RVs surfaces a strong hydrophobic and slick effect that makes maintenance quick and easy, and protects against the dirt, mud, dust, sun and other harsh elements. A simple rinse off is enough to get your RV, ATV, 4x4 or any off-road vehicle back to a brand new look. It also provides UV protection to stop fading and oxidation.

HydoSilex OffRoad will outlast any wax or other surface protection and cannot be washed off. You can add more layers for a longer and stronger protection.

Rest easy knowing HydroSilex OffRoad is working while you play!

## TOUCH UP PAINT

600-05684

**HYDROSILEX REWIND**

Get your RV, 4x4 or other vehicle perfectly prepped before applying your ceramic coating! HydroSilex Rewind removes any grease, oil or wax residue to decontaminate the surface for bonding.



HydroSilex Rewind is a wax and grease remover ideal to use prior to installing HydroSilex ceramic coatings. For the ceramic coating to bond properly, the surface needs to be clean from any wax residue. After washing the car, use Rewind to strip the surface from any wax or grease that may have been part of the wash soap. The surface is then prepared perfectly for OffRoad or Camper.

To apply: Spray Rewind onto the surface of a clean car. Use high-quality clean microfiber towels and buff free of residue. Ensure you don't apply while in direct sunlight.

600-05690

**HYDROSILEX MICROFIBRE TOWELS - 5 PACK****CARAVAN TOUCH UP PAINT**

A powdercoat professional touch up paint, allowing you to repair minor chips and scratches. It has been formulated to match Colorbond® and powdercoat finishes and is suitable for: roofing, aluminium windows, guttering and down spouts, fencing, caravans/ motorhomes, aluminium and steel doors, gardening equipment, railings and boats.

600-06010

**CARAVAN TOUCH UP PAINT VIOLET TONE WHITE - 150G AEROSOL****ROOF SEALER**

Elixir roof coating seals off and provides superior reflectivity helping to lower interior temperatures. It is UV resistant and expands and contracts with the roof.

600-05020

**ROOF SEAL 1L WHITE**Coverage: 5m<sup>2</sup> p/L

Application: Brush, roller, spray gun

Touch Dry: 1-1.5 hours

Not suitable for rubber roofs



600-05024

**ROOF SEAL 4L WHITE**

Curing Time: 24 Hours

Not suitable for rubber roofs

**DICOR LAP SEALANT**

600-05050

**DICOR LAP SEALANT FOR RUBBER ROOFS (11OZ CARTRIDGE)**

600-05052

**DICOR LAP SEALANT FOR VERTICAL SURFACES**

Non-sag and non-levelling, 10.3oz cartridge



600-05100

**DICOR RUBBER ROOF REPAIR KIT**

Repair kit includes lap sealant and rubber patch.

**Specifications**

Patch size: 230 x 250mm



600-06100

**EZYCAULK CAULKING COMPOUND**

Ezycaulk caulking compound 500g tube (white). Caulking butyl rubber sealant is a soft type of non hardening water and dust proofing compound that forms a tough skin but remains permanently soft. Adheres to most common materials i.e. Aluminium, wood, sheet metal and concrete.



**5C SILICONE SEALANT**

VEC5CLM silicone is suitable for weather proofing, aluminium, concrete, glass and where a premium quality silicone sealant is required as a high movement weather seal. Will accommodate approx 50% movement of the original joint.



**600-06110**  
**SILICONE SEALANT VEC5CLM NON ACETIC 370G TUBE GREY**

**V2 SILICONE SEALANT ACETIC CURE**

V2 Silicone sealant is an acetic curing silicone, suitable for glazing applications. Structural fin and butt glazing, fish tanks, ceramics and painted surfaces.

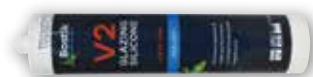

**600-06122**  
**V2 SILICONE SEALANT ACETIC CURE 300G TUBE CLEAR**

**V4 SILICONE SEALANT NON ACETIC**

V4 Silicone sealant is a non acetic curing silicone, suitable for aluminium, perimeter glazing, masonry to metal, high movement applications, potable water tanks, plastics etc. Will accommodate approx 35% movement of the original joint.



**600-06130**  
**V4 SILICONE SEALANT NON ACETIC 370G TUBE WHITE**

**V60 SILICONE SEALANT NON ACETIC**

V60 Silicone sealant is a non acetic curing silicone, suitable for all types of glazing and waterproofing, structural fin and butt glazing, mirrors, aluminium, metal roofing etc. Will accommodate approx 35% movement of the original joint.



**600-06140**  
**V60 SILICONE SEALANT NON ACETIC 300G TUBE CLEAR**

**600-06142**  
**V60 SILICONE SEALANT NON ACETIC 300G TUBE WHITE**



**600-06144**  
**V60 SILICONE SEALANT NON ACETIC 300G TUBE BLACK**



**600-06146**  
**V60 SILICONE SEALANT NON ACETIC 300G TUBE GREY**

**Z-BOND PLUMBERS ROOF & GUTTER SILICONE**

Z-Bond roof and gutter silicone, suitable for sheet metal, aluminium, zincalume, cladding, portable water tanks, etc. Will accommodate approx 25% movement of the original joint.

**600-06150**  
**PLUMBERS ROOF AND GUTTER SILICONE 300G TUBE CLEAR**



**600-06154**  
**BOSTIK 922 IND HIGH TEMP SILICONE ACETIC CURE 300G TUBE TRANSPARENT**

**Z-BOND NO NAILS CONSTRUCTION ADHESIVE**

Z-Bond No Nails construction adhesive is designed for use as an alternative bonding method to nails, screws and rivets etc. No nails is designed for use with wood, plaster board, particle board, masonry, sheet metal, zincalume, wall cladding, ceramics, aluminium, painted surfaces, steel, concrete, brick, floor panels, polystyrene and urethane foam.

**600-06160**  
**NO NAILS CONSTRUCTION ADHESIVE 320G TUBE BEIGE**





## SEALERS

## SIMSON ISR

ISR 70-03 is a good compromise between an adhesive and a sealant. Suitable for elastic bonding and sealing in caravan construction. Available in black and white.

- > Solvent, isocyanate- and PVC free.
- > Very good UV-resistance and ageing properties.
- > In general good adhesion on several substrate without the use of a primer.
- > Permanent elastic within temperatures from -40°C to +120°C.
- > Neutral, odourless and fast curing.
- > Paint compatible with most industrial paint- or lacquer systems, both alkyd resin and dispersion based (due to the large scale of different types of industrial paints a paint compatibility test is recommended).
- > Paintable after skin forming (wet on wet); this will not influence the curing speed

**600-06170**

**SIMSON ISR 70-03 BLACK**



**600-06172**

**SIMSON ISR 70-03 WHITE**

**600-06210**

**STRIP CAULKING**

An ideal sealant for face fixed window flanges, edge moulds etc. It is easily thumbbed into place and smoothed with a finger in instances when a soft, non-hardening material is needed. It is waterproof and will not shrink. (Sold per 16' roll - 4.9m)



## TAPE FOAM PVC SEALING

This general purpose foam tape is manufactured for use in applications requiring positive seals on irregular surfaces or when flex and conformability to tight radius curves are critical considerations.



- > Low density foam is easy to compress and conformable, but is still strong and resilient
- > Insulates against temperature, sound and vibration
- > Formulated from durable Poly Vinyl Chloride (PVC) for long service life.
- > Closed cell structure completely seals out air, moisture, light and dust when compressed at least 30%.

**250-02500**

**GREY 6.4MM THICK  
X 12MM X 15.2M**

**250-02501**

**BLACK 6.4MM THICK  
X 12MM X 15.2M**

**250-02502**

**GREY 9.5MM THICK  
X 12MM X 7.0M**

**250-02503**

**BLACK 9.5MM THICK  
X 12MM X 7M**

**250-02504**

**GREY 12.7MM THICK  
X 12MM X 7.0M**

**250-02505**

**BLACK 12.7MM THICK  
X 12MM X 7M**

**250-02506**

**GREY 6.4MM THICK  
X 18MM X 15.2M**

**250-02507**

**BLACK 6.4MM THICK  
X 18MM X 15.2M**

**250-02508**

**GREY 9.5MM THICK  
X 18MM X 7.0M**

**250-02509**

**BLACK 9.5MM THICK  
X 18MM X 7M**

**250-02510**

**GREY 12.7MM THICK  
X 18MM X 7.0M**

**250-02511**

**BLACK 12.7MM THICK  
X 18MM X 7M**

**650-00070****ELIXIR MINI VENT**

Elixir mini vent 9" x 9"

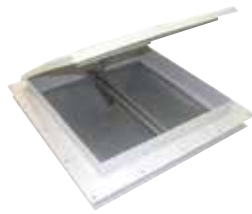
**650-00080****VENTLINE 14" X 14" METAL VENT**

This vent does not have a fan, but does have an extra strong galvanized steel roof flanges in a painted white finish. It has a screw-in mount, while the dome is styled with an aerodynamic shape in white polypropylene. The screen frame has been designed with stylish radius corners (curved) and comes in two removable pieces which is great for cleaning.

**650-00090****VENTLINE 14" X 14" METAL VENT (WITH FAN)**

This Ventline Vent has a 12V DC motor making it able to power a fan for faster air delivery. Like 650-00080, it also has extra strong galvanized steel roof flanges in a painted white finish and mounts onto the roof of your RV with screws. The dome is also white with an aerodynamic design. The screen frame also has radius corners and consists of two removable pieces.

**Specifications**

Cut-out required: 14 1/4" (36.2cm)

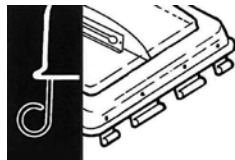
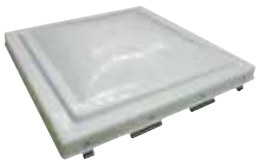
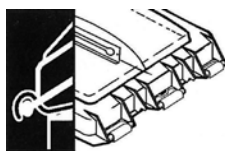
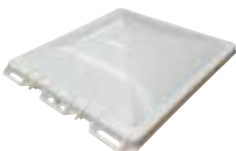
**REPLACEMENT PLASTIC LID (VENTS)****650-00210****REPLACEMENT PLASTIC LID FOR OLD STYLE JENSEN 14" X 14" VENT****650-00212****REPLACEMENT PLASTIC LID FOR NEW STYLE JENSEN 14" X 14" VENT****650-00214****JENSEN HATCH 14"X14" BLACK LID ONLY T/S NEW TYPE**

Camco's Black Polypropylene Replacement Vent Lid for Jensen with pin hinge is impact-resistant and comes preassembled. It includes all mounting hardware for quick, easy installation on all 14" x 14" RV vents. Hardware is rust resistant.

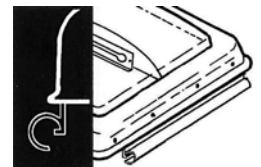

- > Made of durable, impact resistant polypropylene
- > Includes rust-resistant mounting hardware
- > Fits all 14 inch x 14 inch RV vents and replaces Jensen pre 1994 pin style vents
- > Reinforced center bar for added strength and stability
- > Vent lid is pre-assembled for quick and easy installation

**650-00230****REPLACEMENT PLASTIC LID FOR OLD STYLE ELIXIR 14" X 14" VENT****650-00240****REPLACEMENT PLASTIC LID FOR VENTLINE 14" X 14" VENT**

(to suit old metal clip connection)

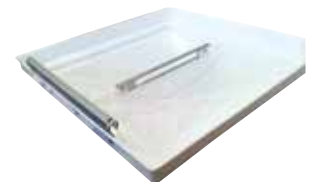
**650-00250****VENTLINE VENT REPLACEMENT LID - SMOKE****650-00450****VENTLINE REPLACEMENT LID**

White lid only, to suit new style plastic clip connection.



## UNIMAXX UNIVERSAL VENT LID REPLACEMENT KIT

Replace damaged or old vent Lids with one, easy-to-install universal vent lid. The Unimaxx universal vent lid takes the hassle out of having to know what year your current lid was manufactured and who manufactured it! Replaces damaged vent lids on Elixir, Hengs, Jensen, Ventline and other roof vent assemblies.

- > Eliminates the need to match hinge types.
- > Preassembled
- > Includes all mounting hardware
- > Uv enforced polypropylene
- > Rust resistant hardware
- > Available in White and Smoke

### 650-00260 UNIMAXX UNIVERSAL VENT LID REPLACEMENT KIT WHITE



### 650-00262 UNIMAXX UNIVERSAL VENT LID REPLACEMENT KIT SMOKE



## JENSEN SPARES

### 650-00400 WINDER HANDLE FOR JENSEN HATCH



### 650-00404 FAN BLADE FOR JENSEN HATCH



## VENTLINE SPARES

### 650-00452 BLACK ELEVATING KNOB Replacement knob only to open/close the vent lid.



### 650-00454 VENTLINE 6" FAN BLADE A plastic fan blade to suit the Ventline 14" x 14" vent.



### 650-00456 VENTLINE REPLACEMENT FLY SCREEN With plastic framework and metal mesh, this replacement fly screen suits 14" x 14" Ventline vents with or without a fan.



### 650-00458 VENTLINE OPERATOR SHORT SHAFT Suits the old style connection, (spring locking clip with crank).



### 650-00460 VENTLINE OPERATOR SHORT SHAFT Suits the new style connection, has a plastic slide clip with crank.



## AUSTRALITE FOUR SEASONS HATCH SPARES

### 650-00554 FOUR SEASONS LIFT MECHANISM



### 650-00556 FOUR SEASONS HATCH FLY SCREEN

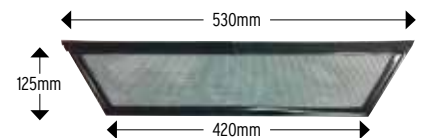

### 650-00560 INTERNAL FRAME TO SUIT NEW FOUR SEASONS HATCH 50MM (part number 650-00595)



**650-00562****INTERNAL FRAME TO SUIT NEW FOUR SEASONS HATCH - 70MM**

(part number 650-00595)

**650-00597****AUSTRALITE FOUR SEASONS EVOLUTION HATCH 600 X 600**

- > Fully designed and tested in Australia for Australasian conditions
- > Retains Camec's famous 4 season functionality
- > Classic 660x660 square cutout means no change, and also makes it retrofittable to upgrade your old 4 seasons hatch
- > Passive ventilation increased to 223cm<sup>2</sup> (was 161cm<sup>2</sup> on previous model)
- > Ergonomic vent controls
- > Each door has three opening positions (closed, rain mode, fully open)
- > New elegant design, matching the 500x700 4 Seasons Evolution Roof Hatch
- > Tough ASA construction resulting in improved sealant adhesion
- > Easy installation from inside the RV
- > Air Deflector integrated into housing.
- > No additional components required.

**650-01030****FANTASTIC VENT 4 1/4" WHITE GARNISH**

Suitable for use with 5000RBT, 6000RBT, 2250 and 3350.

**Specifications**

Cut Out Dimensions: 345W x 345D (mm)

**650-01064****LID ONLY FOR FANTASTIC VENT "WHITE"****650-01200****DOMETIC DUST REDUCTION SYSTEM**

What's the easiest way to keep your caravan clean? Don't let dust enter in the first place! With a rooftop ventilation system like the Dometic Dust Reduction System, you can significantly reduce the amount of dust in your caravan, breathe fresher air and reduce the cleaning time after caravan trips; you don't even need to power it - it works while you drive!

**Features**

- > Stylish Airflow Grille. The grille allows airflow through the unit and prevents debris from entering the vehicle.
- > Modern Design. Modern rooftop unit with a low profile and lightweight design
- > Easy to Use. Changing the air filter is simple thanks to the ceiling cover that is easy to open and close
- > Versatile Installation. Simple and clean design that can be installed in a range of rooftop openings from 285 x 285 mm to 400 x 400 mm
- > Replaceable Air Filters. Additional PM10 air filters sold separately and can be changed in a matter of seconds.

**Specifications**

Dimensions (mm): D473 x H245 x W444

Net Weight: 5kg

Ventilation opening: 150.00cm<sup>2</sup>**FANTASTIC VENTS****650-01011****FANTASTIC VENT 2250 WITH WHITE ARCHED LID**

A ceiling controlled fan with three fan blade speeds. It fits the standard 14" x 14" opening and has a manual lift dome. It operates quietly and features a built-in thermostat, reversible airflow and a high profile base. Comes with a 2yr manufacturer's warranty.

**Specifications**

Weight: 12lbs (5.4kg)

**650-01021****FANTASTIC VENT 3350 WITH WHITE ARCHED LID**

A ceiling controlled fan with three fan blade speeds. It fits the standard 14" x 14" opening and has a power lift dome with a manual override in case of emergency. It operates quietly and features a built-in thermostat, reversible airflow, an automatic 'close' function (if the rain sensor gets wet) and a high profile base. Comes with a 2yr manufacturer's warranty.

**Specifications**

Weight: 12lbs (5.4kg)

## VENTS

**650-02012****FIAMMA ROOF HATCH 160**

With an elegant and aerodynamic design, the Roof Hatch 160 is quiet, thanks to the new outside cover and rubber seal. Its watertight system guarantees rain streams down without the possibility of it coming in. Made with quality UV-resistant material, it also features an adjustable centre support arm. Can be installed on roofs with depths from 25-50mm. Supplied with a permanent airflow system and mosquito net.

**Specifications**

Required cut-out dimensions: 390 x 390 (mm)

**650-02018****FIAMMA TURBO VENT 160**

Installs in 380mm - 400mm openings with 300mm 10 Blade 12V Fan with polar control thermostat.

**650-02030****FIAMMA KOMBI 50CM X 50CM HATCH WHITE**

Opening on all four sides with convenient handles, the Kombi Hatch maintains constant RV ventilation. It is available with a roller blind which has a dark roller and a mosquito screen.

**650-02204****FIAMMA WHITE LID FOR VENT 50X50 (98683-118)****650-02356****FIAMMA VENT 50X50 OUTER FRAME WITH RIGHT AND LEFT ARMS****VENT 28 F AND TURBO-VENT KIT 28 F**

The new 28cm x 28cm roof light is perfect for small rooms, ensuring improved interior light. The discreet and elegant design of the internal frame makes it suitable for any environment and the aerodynamic shape does not require the use of the spoiler.

Equipped with permanent ventilation and robust aluminium mosquito net. Thanks to the Sandwich System mounting system, it is not necessary to drill any further holes in the roof of the vehicle. Can be accessorised with the optional Kit Turbo Vent 28 F for motorising the roof light.

**Features**

- > Greater light and visibility
- > More aerodynamic
- > Complete with double layer cover
- > Equipped with fixed mosquito net
- > Sandwich system installation
- > Optional motorized ventilation kit

**650-02064****FIAMMA VENT 28 F WHITE****650-02066****FIAMMA VENT 28 F CRYSTAL****Specifications**

Dimensions: 28 x 28 cm

Outside dimensions: 32 x 34 cm

Internal dimensions: 31 x 34 cm

Inside light: 25 x 25 cm

Roof thickness (min - max): 2,8 - 6,0 cm

Permanent air flow: 80 cm<sup>2</sup>

**650-02068****FIAMMA TURBO VENT KIT T/S 28 F****Specifications**

Voltage: 12 V

Absorbed power: 25 W

Max electric input: 1,9 A

Max air flow: 9 m<sup>3</sup>/min

Fan diameter: 180 mm

Permanent air flow: 50 cm<sup>2</sup>

## FIAMMA HATCH SPARE PARTS

**650-02200**  
STANDARD LID FOR FIAMMA  
14" X 14" HATCH



**650-02202**  
LID 160 FOR FIAMMA 14" X  
14" HATCH



**650-02208**  
FIAMMA WHITE LID ONLY  
T/S VENT 28



**650-02210**  
HANDLE EXTENSION  
KIT FOR FIAMMA STD.  
14" X 14" HATCH

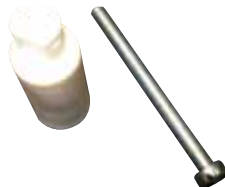

**650-02214**  
WINDING ARM ONLY  
FOR FIAMMA  
14" X 14" HATCH



**650-02216**  
WINDING HANDLE KIT ONLY  
FOR FIAMMA TURBO VENT 1



**650-02222**  
FIAMMA UNIVERSAL KNOB &  
EXTENSION KIT

This universal extension kit allows Fiamma vents to be installed on thicker roofs with thicknesses from 3-8.5cm.



**650-02314**  
FIAMMA ROLLO VENT 40

A roller blind system that is suitable for use on Fiamma 40cm x 40cm vents. It is fixed to the existing vent frame using the screws provided and still allows for permanent ventilation thanks to its side inlets.



## Specifications

Weight: 0.1kg

**650-99000N**  
FIAMMA ROOF HATCH VENT 160  
(CRYSTAL LID)

Made from quality UV-resistant material, the Crystal Roof Hatch provides permanent airflow ventilation and has a mosquito screen to keep out the bugs. It has an aerodynamic design so a spoiler is not required for installation. The outer cover has an exclusive, patented rubber seal which guarantees a watertight system. It is interchangeable with older 40 x 40 cm Fiamma roof lights, as well as 36 x 36 (cm) - 42 x 42 (cm) roof lights thanks to the reinforced frame. To block out the sun, the Fiamma Rollo Vent 40 can be purchased.



## Specifications

Weight: 2.8kg

## VENTS

## MAXXAIR VENTILATION SYSTEMS

RV ventilation has never been easier than with a MaxxFan.

They've been used in the US RV market since 1988, and they are now exclusively available from Coast to Coast. The MaxxFan Plus and the MaxxFan Deluxe, both have

a manual option and an electric opening option, and they also have a ceiling mounted control panel that is easy to use and read.

**Some other features include:**

- > Removable flyscreen - simply twist the L-clamps and remove for cleaning!
- > Installs onto all standard 14" x 14" (356mm x 356mm) roof openings
- > Powerful 10-speed fan motor
- > Fan can run even if the lid is closed (select 'Ceiling Fan Mode') and can be used in "intake" and "exhaust" modes
- > Provides over 900CFM, keeping your RV cool and comfortable
- > Twin lifting arms limit vibrations cause by wind when in the 'open' position



Removable Flyscreen



Twin Lifting Arms

**650-03010****MAXXFAN PLUS WITH THERMOSTAT AND MANUAL LIFT**

Specifications	
Amp Draw on High	2.6A
Amp Draw on Low	0.17A
Dimensions (closed)	461L x 420W x 97H (mm)
Dimensions (open)	461L x 420W x 311H (mm)
Installed Weight	4.1kg
Roof Thickness	50mm (min) - 110mm (max)

**650-03012****MAXXFAN PLUS WITH THERMOSTAT, POWER LIFT, RAIN SENSOR AND REMOTE**

Specifications	
Amp Draw on High	2.6A
Amp Draw on Low	0.17A
Dimensions (closed)	461L x 420W x 97H (mm)
Dimensions (open)	461L x 420W x 311H (mm)
Installed Weight	4.1kg
Roof Thickness	50mm (min) - 110mm (max)

**650-03014****MAXXFAN DELUXE WITH RAIN DOME, THERMOSTAT AND MANUAL LIFT**

Specifications	
Amp Draw on High	2.5A
Amp Draw on Low	0.16A
Dimensions (closed)	589L x 421W x 128H (mm)
Dimensions (open)	589L x 421W x 230H (mm)
Installed Weight	5.4kg
Permanent Airflow	82cm <sup>2</sup>
Roof Thickness	25mm (min) - 90mm (max)

**650-03016****MAXXFAN DELUXE WITH RAIN DOME, THERMOSTAT, POWER LIFT AND REMOTE**

Specifications	
Amp Draw on High	2.5A
Amp Draw on Low	0.16A
Dimensions (closed)	589L x 421W x 128H (mm)
Dimensions (open)	589L x 421W x 230H (mm)
Installed Weight	5.4kg
Roof Thickness	25mm (min) - 90mm (max)

**650-04000****AERO FLO VENT COVER FOR 14" X 14" ROOF VENT**

Get high flow fresh air ventilated throughout your RV in rain or sunshine. It has a swing open top for easy cleaning and because it has vents on three sides it has 30% more open vent area than some other vent covers. Made from UV stabilized resin it mounts easily to existing 14" x 14" roof vents.

**650-04020****MAXXAIR STANDARD VENT COVER**

THE MAXXAIR ORIGINAL VENT COVER. Lets in FRESH AIR ANY TIME... Rain or Shine!

- > Prevents Heat Buildup in your RV
- > Proven SUPER-TOUGH one piece design
- > Mounts to all existing 14" x 14" roof vents INCLUDING the new Ventline E-Z Lift Ventadome



Not recommended for High-Powered Fans like MAXXFAN, MAXXFAN Plus Fans, ShurFlo Fan or Fantastic Fan.

## SKYMAXX & SKYMAXX PLUS



Natural light and fresh air - the basic fundamentals to the richness of our individual lives and our unique living environments. Light and fresh air create within us a variety of moods that often make any surrounding an oasis.

While enjoying time with family, neighbours or just simply relaxing, MAXXAIR's new SKYMAXX Series of skylights can add so much function, drama, balance and ventilation to any environment.

### Features

- > Natural light makes small spaces feel open and free.
- > Create drama in any space.
- > Bring the balance and harmony of nature indoors.
- > With the ability to open the SKYMAXX, create a cooling effect and bring fresh air throughout your RV.
- > Create more opportunities for natural light without sacrificing privacy.

The SKYMAXX is available in two sizes: SKYMAXX and SKYMAXX LX. Both sizes are offered with or without 12V LED accent lighting. All models come with a screen and shade that can either be:

- > Fully Open
- > Screen Only
- > Shade Only
- > 1/2 Shade and 1/2 Screen

## SKYMAXX AND SKYMAXX PLUS

### Features

- > Skymaxx - Non-LED
- > Skymaxx Plus - LED
- > Manual lift with 3 open positions
- > Pleated screen & shade provides options of full sun-full shade, partial sun/shade
- > Fits 15.75" x 15.75" (400mm x 400mm) opening
- > Sized for 0.90" to 2.36" (23mm to 60mm) roof thicknesses with no cutting required
- > Optional passive ventilation
- > White interior frame
- > LED operates on 12 VDC, 2 amp service
- > RoHS compliant

### 650-03020

**SKYMAXX 400 X 400MM SKYLIGHT WITH INTERNAL BLIND (23/60MM)**

### 650-03022

**SKYMAXX PLUS 400 X 400MM SKYLIGHT WITH INTERNAL BLIND & LED (23/60MM)**



Fully Open

Screen Only

Shade Only





## VENTS

**Features**

- > Skymaxx LX - Non-LED
- > Skymaxx LX Plus - LED
- > Manual lift with 4 open positions
- > Pleated screen & shade provides options of full sun-full shade, partial sun/shade
- > Fits 27.5" x 19.70" (700mm x 500mm) opening
- > Sized for 0.90" to 2.36" (23mm to 60mm) roof thicknesses with no cutting required
- > Optional passive ventilation
- > White interior frame
- > LED operates on 12 VDC, 2 amp service
- > RoHS compliant

**650-03026**

**SKYMAXX LX 700 X 500MM SKYLIGHT WITH INTERNAL BLIND (23/42MM)**

**650-03028**

**SKYMAXX LX PLUS 700 X 500MM SKYLIGHT WITH INTERNAL BLIND & LED (23/42MM)**

**650-03030**

**SKYMAXX LX 700 X 500MM SKYLIGHT WITH INTERNAL BLIND (42/60MM)**

**650-03032**

**SKYMAXX LX PLUS 700 X 500MM SKYLIGHT WITH INTERNAL BLIND & LED (42/60MM)**



Fully Open



Screen Only



Shade Only

**650-04030**

**CAMCO LIGHTS OUT RETRACTABLE RV ROOF VENT SHADE**

Camco RV Cream Retractable Lights Out Vent Shade prevents light from shining into RV sleeping quarters at night. Easily mounts to ceiling and retracts into the space-efficient housing to allow light inside during the day. Opens to 14-1/8" x 19". Durable, lightweight vinyl's reflective finish reflects heat to keep RV cool.



- > Easy installation
- > Reflects heat to keep the RV cool
- > Opens to 14-1/8" x 19"
- > Prevent light from shining into RV at night
- > Easily retracts to let light in during the day

**650-04100**

**MULLER WHITE PVC EXTERIOR VENT**

Muller White PVC Exterior Vent

**650-04110**

**ROTARY VENT PLASTIC WHITE**

Manufactured from high grade plastic (abs), exceptional on transportation vehicles such as buses, RV's, animal transport vehicles, delivery vans and marine vessels. Has a corrosion resistant stainless steel centre shaft.

**Specifications**

Dimensions: 240D x 120H (mm)

**650-04150**

**SCUPPER VENT WHITE (SMALL)**

Powder coated aluminium in white with one spring.

**Specifications**

Dimensions: 170L x 112W (mm)

**650-04160****SCUPPER VENT INTERNAL  
FRAME PLASTIC**

Suitable for use with the small vent only  
(i.e. with 650-04150).

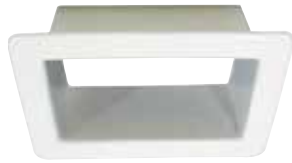
**650-04170****SCUPPER VENT WHITE  
(LARGE)**

Powder coated aluminium in white with  
two springs.

**Specifications**

Dimensions: 242L x 149W x 20H (mm)

**650-04175****SCUPPER VENT INTERNAL  
FRAME FOR LGE VENT****650-04178****SCUPPER VENT REPAIR KIT FOR SMALL VENT****650-04179****SCUPPER VENT REPAIR KIT FOR LARGE VENT**





# SECTION 6

## MAJOR APPLIANCES

(Product Group - 700)

Rangehoods	228
Washing Machines and Spare Parts	229 - 231
Fridge Fans	232
Waeco Refrigeration	233 - 234
Dometic Refrigeration and Accessories	234 - 236
Thetford Refrigeration	237 - 240
Thetford Cooking Appliances	240 - 245
Dometic Cooking Appliances	246
Lido Stoves	246
Barbeques	247 - 248
Sphere Microwave	248
My Coolman Fridges	249 - 250
Sphere RVX Fridge Freezers	251 - 252



## RANGEHOODS

## DOMETIC RANGEHOODS

**700-00100**  
**CK150 RANGEHOOD 12V**  
**FLUSH MOUNT**



**700-00110**  
**CK155 RANGEHOOD 12V**  
**SURFACE MOUNT**



## SPHERE™ RANGEHOODS (12V)

Cooking in confined spaces can sometimes create unwanted scents and condensation on your RV's splashback. By installing a rangehood, hot and foul smells are quickly extracted up and out of your RV. Comprising of three models, the rangehoods are easy to install thanks to their compact size. This range features an LED lighting strip and easy to remove filters (for cleaning).

**700-06200**  
**SPHERE™ TOUCH CONTROL**

Features a tempered glass front panel with an LCD display and a stainless steel body. Suitable for installation underneath a cupboard.

**Specifications**

Dimensions: 530W x 304D x 60H (mm)

Air Flow: 100m<sup>3</sup>/hr

Total Input: 35W



**FIND YOUR  
 NEAREST  
 STOCKIST**

Over 300 independent  
 stockists throughout  
 Australia & New Zealand

Find your nearest stockist at [coastrv.com.au](http://coastrv.com.au)

## SPHERE™ AUTOMATIC MINI WASHING MACHINES



Take caravan and camping trips to a new level of comfort and convenience with the Sphere 3.5kg 12V Automatic Washing Machine. Off the grid automatic washing has never been easier! The need to wait your turn to use the caravan park laundry is over because you're now able to do your laundry when it is convenient for you and all with power from your onboard battery system! An Anderson plug comes included as standard to allow for a quick and simple connection. The Sphere Automatic Mini Washing Machine has five process settings from a wash-rinse-spin cycle (lasting approx. 38mins) to a simple spin cycle (lasting approx. 7mins). Wash settings are set via the uncomplicated control panel. This washing machine is suitable to cold wash only but has the adaptability of having the drainage hose outlet on either the left or right side of the machine. With an elegant white body and stainless-steel wash tub, it will fit the interior decor of any RV.

### 700-00352 AUTO MINI WASHING MACHINE (2.6KG)

#### Specifications

**Power Supply:** 240V/50Hz  
**Max Water Volume:** 20L  
**Weight:** Gross - 18kg, Net - 16kg  
**Dimensions:** 410W x 420D x 640H (mm)



### 700-00364 12V AUTO MINI WASHING MACHINE (3.3KG)

- > Has a newly designed carry basket with locking clips
- > Has an 'out of balance' sensor
- > Stainless steel wash tub
- > Now features rubber hoses with stainless steel "screw" clamps
- > Durable lint filter similar to domestic standards
- > has time display shows time remaining in the cycle or in event of an error, it shows the fault code
- > Has an Auto Power Off function - at the end of your selected washing cycle, a buzzer will sound up to six times before turning the power off
- > You can select your water level usage (depending on your load size), which saves your water and detergent! The 3.5kg has three level settings



### 700-00362 AUTO MINI WASHING MACHINE (3.3KG)

#### Specifications

**Power Supply:** 240V/50Hz  
**Max Water Volume:** 26L  
**Weight:** Gross - 20kg, Net - 18.5kg  
**Dimensions:** 410W x 420D x 740H (mm)

#### Specifications

**Load Capacity:** 3.5kg (dry laundry)  
**Power Supply:** 12V DC  
**160W Wash Power/130W Spin Power**  
**3.3amps per wash (approx. 30 washes from 100 AH battery)**  
**Max Water Volume:** 26L Net  
**Inlet hose:** Cold connection only  
**Max water usage:** 78L per load (on high setting)  
Cold water only  
**Weight:** 18.5kg  
**Dimensions:** W410mm x D420mm x H740mm (+ 240mm with lid up)

## WASHING MACHINE SPARES

**700-00800**  
**SPHERE™ WASHING MACHINE**  
**TOP LID**



**700-00816**  
**SPHERE WASHING**  
**MACHINE WATER INLET**  
**HOSE**



**700-00803**  
**SPHERE WASHING MACHINE**  
**WATER LEVEL SENSOR**



**700-00817**  
**SPHERE WASHING**  
**MACHINE PLASTIC BASKET**  
**FOR LINING**



**700-00806**  
**SPHERE WASHING**  
**MACHINE SPRING**



**700-00818**  
**SPHERE WASHING MACHINE**  
**UP DRAIN HOSE**



**700-00807**  
**SPHERE WASHING MACHINE SAFETY**  
**SWITCH**



**700-00819**  
**SPHERE WASHING MACHINE PUMP**

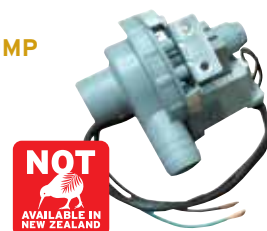

**700-00810**  
**SPHERE WASHING MACHINE**  
**LINT**  
**FILTER KIT**



**700-00822**  
**SPHERE WASHING**  
**MACHINE CONNECT**  
**RUBBER HOSE**



**700-00812**  
**SPHERE WASHING MACHINE**  
**V-BELT**





# SPHERE ECOSPIN

## SPHERE ECOSPIN PORTABLE WASHER



Sphere EcoSpin Portable Washer is a hand-powered spin cycle clothes washer. Gentle on clothes this Eco-friendly laundry option is the perfect choice for when you're off the beaten trail.

The Sphere EcoSpin Portable Washer can wash up to 2L of laundry in just minutes. This time and money saver requires no electricity and uses less water and detergent than traditional washing machines. Its clever design is gentle on clothes, there are no protruding elements to cause damage like other hand powered washers. It takes less effort to spin compared to other hand powered washers and the EcoSpin can even spin dry your clothes so they dry faster on the line.

The lightweight, highly portable Sphere EcoSpin portable washer is the perfect option for free camping, caravanning and fishing.

### 700-00370

#### SPHERE ECOSPIN PORTABLE WASHER

##### Features

- > Easy to use
- > Compact and sturdy design
- > Tight locking lid
- > Fold down crank handle
- > Directional drainage hose
- > Four feet for excellent grip
- > 1 Year Warranty

##### Specifications

Dimensions: 345 x 344 x 343mm

Load capacity: 2L

Wash time: 2 minutes

Spin time: 30 seconds



## FRIDGE ACCESSORIES

**700-01050**  
**FRIDGE FAN (SOLAR)**

**NOT**  
AVAILABLE IN  
NEW ZEALAND

**700-01100**  
**CAMCO REFRIDGERATOR**  
**VENT COVER TOP ONLY**

**NOT**  
AVAILABLE IN  
NEW ZEALAND

**700-01102**  
**CAMCO REFRIDGERATOR**  
**VENT BASE**

**NOT**  
AVAILABLE IN  
NEW ZEALAND

**WAECO ADAPTERS****700-02402**  
**WAECO 110 - 240V AC TO**  
**24V POWER ADAPTER**  
**(MPS-50A)**

Suits all Waeco CDF and CF models, has an output current of 6A.



**NOT**  
AVAILABLE IN  
NEW ZEALAND

**Specifications**

Dimensions: 120W x 70H x 200D mm

**700-02414**  
**WAECO EPS817A POWER**  
**ADAPTER**

A 240V to 12VDC adapter; suitable for use with: CF18, CF25Vera, CDF35Pack and CDF11; also suitable for use with all 12V thermoelectric coolboxes.



**NOT**  
AVAILABLE IN  
NEW ZEALAND

**Specifications**

Dimensions: 115W x 65H x 170D (mm)

**700-03000**  
**RV ELECTRONICS FRIDGE**  
**SWITCH**

Has an inbuilt electronic movement & vibration sensor which switches the 12v circuit of the caravan's 3-way fridge "on" when the vehicle is moving & turns the fridge "off" when the vehicle stops.



Fridgeswitch has a varying timing circuit which may keep the fridge turned on for up to 3 minutes after the vehicle has stopped. This is to keep the fridge turned on while you are stopped at traffic lights.

- > No more flat batteries when the fridge is left on
- > Only one auxiliary line needed
- > Automatically turns your caravan fridge on and off
- > Easy 15 minute installation

# WAECO FRIDGES

## WAECO COOLMATIC CRX FRIDGE FREEZERS

Equipped with energy efficient genuine WAECO compressors, the well-proven WAECO CoolMatic refrigerator series provide outstanding energy efficient refrigeration for built-in mobile applications. Their operation is reliable even in tilted positions and high ambient temperatures. They work economically, quietly and are ideal to run with solar panels.

The various models of the CoolMatic series satisfy all mobile fridge requirements. There's a matching refrigerator for every size of vehicle and for every room situation. With a modern stylish exterior, plus well organised and practical interior, the WAECO CoolMatic CRX range are the logical choice for your caravan, motorhome, yacht or boat.

### 700-03102 WAECO COOLMATIC CRX 50

#### Specifications

Storage volume (approx.): 45L

Freezer compartment: 4.4L

Voltage: 12/24 V DC

Average Power Consumption: approx. 40 W

Current Consumption at 12V: 1.1 Ah/h at +25°C ambient temperature, 1.7 Ah/h at +32°C ambient temperature, both at +5°C interior temperature

Temperature Range: approx. +12 to -15°C

Dimensions (W x H x D): 380 x 534 x 447mm

With Flush-mount Frame: 406 x 536 x 495mm

With Standard frame: 384 x 536 x 447mm



### 700-02980 WAECO CR-50 STANDARD MOUNTING FRAME

### 700-02990 WAECO CR-50 FLUSHMOUNT MOUNTING FRAME

### 700-03104 WAECO COOLMATIC CRX 65

#### Specifications

Storage volume (approx.): 57L

Freezer compartment: 7.0L

Voltage: 12/24 V DC

Average Power Consumption: approx. 45 W

Current Consumption at 12V: 1.4 Ah/h at +25°C ambient temperature, 1.8 Ah/h at +32°C ambient temperature, both at +5°C interior temperature

Temperature Range: approx. +12 to -15°C

Dimensions (W x H x D): 448 x 525 x 492mm

With Flush-mount Frame: 474 x 527 x 540mm

With Standard frame: 452 x 527 x 492mm

Without door: 448 x 525 x 492 mm

Weight (approx.): 19.0 kg



### 700-02982 WAECO CR-65 STANDARD MOUNTING FRAME

### 700-02992 WAECO CR-65 FLUSHMOUNT MOUNTING FRAME

### 700-03106 WAECO COOLMATIC CRX80

#### Specifications

Storage volume (approx.): 78L

Freezer compartment: 7.5L

Voltage: 12/24 V DC

Average Power Consumption: approx. 50 W

Current Consumption at 12V: 1.9 Ah/h at +25°C ambient temperature, 2.0 Ah/h at +32°C ambient temperature, both at +5°C interior temperature

Temperature Range: approx. +12 to -15°C

Dimensions (W x H x D): 475 x 640 x 475mm

With Flush-mount Frame: 501 x 642 x 523mm

With Standard frame: 479 x 642 x 475mm

Weight (approx.): 21.0 kg



### 700-02984 WAECO CR-80 STANDARD MOUNTING FRAME

### 700-02994 WAECO CR-80 FLUSHMOUNT MOUNTING FRAME

# WAECO FRIDGES

## 700-03108

### WAECO COOLMATIC CRX110

#### Specifications

Storage volume (approx.): 104L  
 Freezer compartment: 9.0L  
 Voltage: 12/24 V DC  
 Average Power Consumption: approx. 65 W  
 Current Consumption at 12V: 1.8 Ah/h at +25°C ambient temperature, 2.4 Ah/h at +32°C ambient temperature, both at +5°C interior temperature  
 Temperature Range: approx. +12 to -15°C  
 Dimensions (W x H x D): 520 x 745 x 558mm  
 With Flush-mount Frame: 546 x 747 x 606mm  
 With Standard Frame: 524 x 747 x 558mm  
 Weight (approx.): 26.0 kg



## 700-03510

### DOMETIC RM2350 3-way 90L fridge 12V/240V/gas

#### Specifications

Dimensions: H 766 x W 550 x D 565mm



## 700-02986

### WAECO CR-110 STANDARD MOUNTING FRAME

## 700-02996

### WAECO CR-110 FLUSHMOUNT MOUNTING FRAME

## 700-03110

### WAECO COOLMATIC CRX140

#### Specifications

Storage volume (approx.): 130L  
 Freezer compartment: 11.0L  
 Voltage: 100/24 V AC 12/24 VDC  
 Average Power Consumption: approx. 65 W  
 Current Consumption at 12V: 1.89 Ah/h at +25°C ambient temperature, 2.5 Ah/h at +32°C ambient temperature, both at +5°C interior temperature  
 Temperature Range: approx. +12 to -15°C  
 Dimensions (W x H x D): 525 x 815 x 620mm  
 With Flush-mount Frame: 551 x 817 x 668mm  
 With Standard frame: 529 x 817 x 620mm  
 Weight (approx.): 27.5 kg



## 700-12304

### DOMETIC RU 8408X ABSORPTION REFRIGERATOR 216L

The Dometic RU 8408X is a single door upright absorption refrigerator that features a narrow cabinet design for greater flexibility in the kitchen area of recreational vehicles without compromising on storage volume.

#### Specifications

Dimensions: W 677 D x 1657 H x 550  
 Net weight: 64kg  
 Gross volume: 224L  
 Storage volume: 170L  
 Fridge Storage Volume: 170L  
 Freezer Storage Volume: 46L  
 Input Voltage (AC): 230V-240V  
 Input Voltage (DC): 12V  
 Rated Input Power (AC): 325W  
 Rated Input Power (DC): 275W



## 700-02988

### WAECO CR-140 STANDARD MOUNTING FRAME

## 700-02998

### WAECO CR-140 FLUSHMOUNT MOUNTING FRAME

## DOMETIC SPARES

**700-03540****DOMETIC A1625 VENT KIT**

Vent kit with T piece for Dometic 3 way refrigerator, suitable for absorption fridges. These are fitted on the outside of the van behind the fridge to allow air flow.

*Must order 700-03541 - DOMETIC T PIECE T/S AS1625 (2 PIECE KIT). TP-KIT) to make complete kit.*

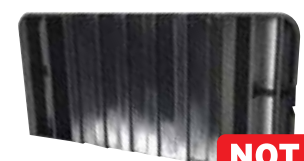
**700-03563****DOMETIC LOWER FRAME T/S AS1625 WHITE****700-03544****DOMETIC LOCKING CLIP FOR A1625 VENT KIT****700-03567****DOMETIC UPPER VENT FLUE INSERT****700-03543****DOMETIC UPPER VENT T/S AS1625 WHITE****700-03580****DOMETIC UPPER FRAME T/S AS1625 BLACK****700-03582****DOMETIC UPPER VENT T/S AS1625 VENT BLACK****700-03548****DOMETIC LS300 VENT KIT (FRAME & GRILL) WHITE****700-03584****DOMETIC LOWER FRAME T/S AS1625 BLACK****700-03549****DOMETIC LS300 VENT KIT (FRAME & GRILL) BLACK****700-03565****DOMETIC UPPER FRAME T/S AS1625 WHITE****700-03586****DOMETIC LOWER VENT T/S AS1625BLACK****700-03564****DOMETIC LOWER VENT T/S AS1625 WHITE****700-03588****DOMETIC UPPER VENT FLUE INSERT BLACK**

## DOMETIC SPARES

700-03680

DOMETIC SPRING L/H T/S  
RM2330/2310

700-03656

DOMETIC ELEMENT 240V 135W FOR  
RM4401/4400

700-03691

DOMETIC SPRING R/H T/S  
RM2330/2310

700-03660

DOMETIC SPRING HOUSING RH  
FOR RM2330/2310

700-03684

DOMETIC FLUE KIT+T-PIECE.  
3776

700-03662

DOMETIC SPRING HOUSING LH  
FOR RM2330/2310

700-03650

DOMETIC ELEMENT 240V 195W  
FOR RM2453/RM2553

700-03652

DOMETIC ELEMENT 240V 175W FOR  
RM2330/RM2350

# THETFORD FRIDGES

## THETFORD 3-WAY FRIDGES AND VENTS

For more than 40 years, Thetford has been designing and developing refrigerators for the leisure market. Thetford absorption refrigerators work differently than your fridge at home. Thetford 3-way refrigerators have no compressor, making them much quieter. This means you can relax and enjoy a pleasant stay in your caravan or camper, without noisy appliances buzzing in the background. Not stopping with mere production, Thetford continues to develop and innovate in terms of quality, design and ease of use. Thetford refrigerators are extensively tested to high quality standards, are AGA approved and carry the CE mark. Plus Thetford refrigerators come with a full three year warranty.

### 700-03883 90L 3-WAY REFRIGERATOR (N314-E)

- > Compact model (90L gross capacity)
- > Electric display
- > Automatic Energy Selection (SES)
- > AGA (The Australian Gas Association) approved to the latest Australian standards
- > Adjustable thermostat to respond to high ambient temperatures and varied use
- > Flame current meter monitors gas ignition
- > Easy-to-clean, durable white, powder-coated shelves
- > Includes one ice tray
- > Contemporary design with ergonomic controls and latch.



#### Specifications

**Dimensions Including Depth of Door:** 770H x 556W x 582D (mm)  
**Enclosure Cut-Out Dimensions:** 756H x 521W x 543D (mm)  
**Total Gross Capacity:** 90L (approx.)  
**Freezer Compartment:** 11L (approx.)  
**Energy Consumption on 12V/240V:** 2.7kW/24hr (approx.)  
**Energy Consumption on Gas:** 12g/hr (approx.)  
**Net Weight:** 28kg  
**Cooling Fan:** n/a

### 700-03772 THETFORD N3141A 140LT SES 3 WAY FRIDGE REVERSIBLE HAND

Thetford Australia proudly introduces a new fridge for the RV market, the N3141-A. The new N3141-A is the ultimate space saver which also offers the best cooling performance. The state-of-the-art LCD display with touch screen and the unique external drawer make the fridge super easy to use.



#### Specifications

**Dimensions Including Depth of Door:** 1510H x 439W x 561D (mm)  
**Total Volume incl. freezer:** 141L  
**Freezer Compartment:** 15L  
**Usable Power Source:** DC/AC/Gas  
**Control Panel:** LCD  
**Door Shape:** Flat Framed  
**Net Weight:** 38kg

# THETFORD FRIDGES

## 700-03920

### THETFORD 166L SES 3 WAY ELECTRONIC ABSORPTION FRIDGE (N514-E)

- > Larger model (166L gross capacity)
- > Electric display
- > Automatic Energy Selection (SES)
- > AGA (The Australian Gas Association) approved to the latest Australian standards
- > Adjustable thermostat to respond to high ambient temperatures and varied use
- > Flame current meter monitors gas ignition
- > Easy-to-clean, durable white, powder-coated shelves
- > Includes one ice tray
- > Contemporary design with ergonomic controls and latch.



#### Specifications

**Dimensions Including Depth of Door:** 1090H x 625W x 640D (mm)  
**Enclosure Cut-Out Dimensions:** 1083H x 602W x 610D (mm)  
**Total Gross Capacity:** 166L (approx.)  
**Without Freezer Compartment:** 144L (approx.)  
**Freezer Compartment:** 20L (approx.)  
**Usable Power Source:** DC/AC/Gas  
**Energy Consumption 12v/240v:** 3.5kWh/24h  
**Energy Consumption Gas:** 17gr/h  
**Door Shape:** Flat / Framed  
**Net Weight:** 40kg  
**Cooling Fans:** 1

## THETFORD 171L SLIMLINE N4175 FRIDGE

A large, 175L double-door absorption refrigerator that stays constantly cool. This model with LED control panel guarantees a cabinet temperature that is always perfect regardless the power supply (between 210 and 250V). The desired energy source is selected automatically for this refrigerator.

- > Our refrigerators are extensively tested to high quality standards.
- > First class cooling performance
- > Big and spacious



#### Specifications

**Control panel:** LED  
**Dimensions incl. depth door (hxwx):** 1245 x 525 x 628 (mm)  
**Door shape:** Curved framed  
**Door type hinging\*:** Left  
**Energy consumption\*\*:** 4.0 kWh/24h  
**Energy consumption gas\*\*:** 420 g/24h  
**Energy Selection (or Power source selection):** Automatic  
**Freezer volume:** 31 L  
**Net weight:** 39.5 Kg  
**Refrigerant amount:** 126g  
**Refrigeration technology:** Single pressure absorption refrigerator  
**Total volume incl. freezer:** 175 L  
**Type of refrigerant:** Ammonia

## 700-03922

### THETFORD LH 171L SLIMLINE N4175 FRIDGE

## 700-03924

### THETFORD RH 171L SLIMLINE N4175 FRIDGE BLK



**700-03902**  
**THETFORD T1152 152**  
**LITRE SLIM COMPRESSOR**  
**FRIDGE**

Following the slim refrigerators of only 418 mm wide and the growing interest for compressor refrigeration, Thetford developed the T1152. A powerful 152L compressor refrigerator.



- > Thetford refrigerators are extensively tested to high quality standards
- > First class cooling performance
- > Optimal use of space

**Specifications**

Dimensions Including Depth of Door: 1500H x 418W x 578D (mm)  
 Door Shape Flat Framed: 10 mm  
 Energy Consumption-Day Mode: 0.3 kWh/24h (16°C) / 0.7 kWh/24h (32°C)  
 Energy Consumption-Night Mode: 0.2 kWh/24h (16°C) / 0.7 kWh/24h (32°C)  
 Freezer Volume: 18L  
 Gross Volume Fresh Food Compartment: 133 L  
 Net Weight: 34kg

**700-03730**  
**THETFORD TOP OUTSIDE**  
**VENT FOR 3-WAY FRIGDES**  
**(WHITE)**

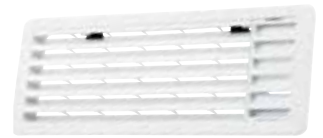

**Specifications**

Main Dimensions: 186H x 483W (mm)  
 Cut Out Dimensions: 156 x 451W (mm)  
 Net Weight: 0.5kg

**700-03732**  
**THETFORD BOTTOM**  
**OUTSIDE VENT FOR 3-WAY**  
**FRIGDES (WHITE)**



**Specifications**

Main Dimensions: 186H x 483W (mm)  
 Cut Out Dimensions: 156 x 451W (mm)  
 Net Weight: 0.5kg

**700-03724**  
**THETFORD INDEPENDENT**  
**FLUE KIT - WHITE**



**700-03725**  
**THETFORD INDEPENDENT**  
**FLUE KIT - BLACK**



**700-03722**  
**THETFORD FLUE KIT**  
To suit N304, N504 and N604



**700-03736****THETFORD TOP OUTSIDE VENT FOR 3-WAY FRIDGES (BLACK)****Specifications**

Main Dimensions: 186H x 483W (mm)  
Cut Out Dimensions: 156 x 451W (mm)  
Net Weight: 0.5kg

**700-03738****THETFORD BOTTOM OUTSIDE VENT FOR 3-WAY FRIDGES (BLACK)****Specifications**

Main Dimensions: 186H x 483W (mm)  
Cut Out Dimensions: 156 x 451W (mm)  
Net Weight: 0.5kg

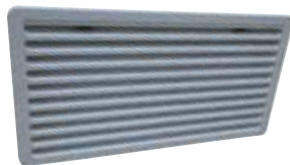
**700-03837****THETFORD LARGE FRIDGE VENT WHITE****Specifications**

Main Dimensions: 281H x 533W (mm)  
Cut Out Dimensions: 248 x 488W (mm)  
Net Weight: 0.7kg

**700-03740****THETFORD LARGE FRIDGE VENT BLACK****Specifications**

Main Dimensions: 281H x 533W (mm)  
Cut Out Dimensions: 248 x 488W (mm)  
Net Weight: 0.7kg

**700-03776****THETFORD SR, VENT 257 X 432 L.GREY****THETFORD COOKING APPLIANCES**

Who says you can't enjoy culinary cooking in your camper, caravan or holiday home? With the well-designed hobs, ovens, grills and sinks from Thetford, you can! Thetford cooking appliances are designed to be as home like as possible. Thetford uses the highest quality materials and thoroughly test each appliance to ensure its ultimate safety - and your satisfaction. All Thetford cooking appliances are designed and manufactured in the British city of Sheffield, and they come with a three year manufacturer's warranty.

**700-04004****THETFORD SPINFLO K1520 ALL IN ONE OVEN COOKTOP(3GAS + 1 ELC) + GRILL**

This all-in one combination cooker with 3 gas burner and 1 electric hotplate stove, grill and oven brings RV cooking to another level. Light, fast, big and delicious. Less weight, higher quality.

- > High-quality materials and components
- > Contemporary, home-like design
- > Optimal use of space
- > Superior cooking performance

**Specifications**

12V spark ignition: Yes  
Amount of burners: 4  
Build-in dimensions (HxWxD): 640 x 496 x 493 mm  
Electric hot plate (220-240V 50Hz): 1025 W Ø 145 mm  
Gas hot plate burners: 1x 0,95 kW 2x 1,70 kW  
Grill burner: 1,65 kW  
Grill capacity: 15 L  
Oven burner: 1,75 kW  
Oven capacity: 34 L  
Overall dimensions (hxwxh): 645 x 515 x 501 mm  
Pan rest: 1 piece  
Total 230V power: 1025 W \*Hotplate  
Total heat input: 7,45 kW  
Weight: 25.5 kg

# THETFORD COOKING APPLIANCES

## 700-04011

### THETFORD SPINFLO K1520 ALL IN ONE OVEN COOKTOP(4GAS)+GRILL

All-in one combination cooker with 4 gas burner stove, grill and oven brings RV cooking to another level. Light, fast, big and delicious. Less weight, higher quality.

- > High-quality materials and components
- > Contemporary, home-like design
- > Optimal use of space
- > Superior cooking performance



#### Specifications

12V spark ignition: Yes

Amount of burners: 4

Build-in dimensions (HxWxD): 640 x 496 x 493 mm

Electric hot plate (220-240V 50Hz): n.a.

Gas hot plate burners: 1x 0,95 kW / 3x 1,70 kW

Grill burner: 1,65 kW

Grill capacity: 15 L

Oven burner: 1,75 kW

Oven capacity: 34 L

Overall dimensions (hxwx d): 645 x 515 x 501 mm

Pan rest: 1 piece

Total 230V power: n.a.

Total heat input: 9.75 kW

Weight: 24.5 kg

## 700-04033

### THETFORD SPINFLO MINIGRILL K1540 COOKTOP(4 GAS)+GRILL

All-in one combination cooker with 4 gas burner stove and grill brings RV cooking to another level. Light, fast, big and delicious. Less weight, higher quality.

- > High-quality materials and components
- > Contemporary, home-like design
- > Optimal use of space
- > Superior cooking performance

#### Specifications

12V spark ignition: Yes

Amount of burners: 4

Build-in dimensions (HxWxD): 312 x 496 x 493 mm

Door opening grill: Drop down

Electric hot plate (220-240V 50Hz): n.a.

Gas hot plate burners: 1x 0,95 kW 3x 1,70 kW

Grill burner: 1,65 kW

Grill capacity: 15 L

Main dimensions (h x w x d): 310 x 515 x 501 mm

Net weight: 14,5 kg

Pan rest: 1 piece Black Enamel

Total 230V power: n.a.

Total heat input: 7,7 kW

Weight: 14.5 kg

## 700-04022

### THETFORD SPINFLO MINIGRILL K1540 COOKTOP(3GX1E)+GRILL

This combination cooker with 3 gas burners and 1 electric hotplate stove, and grill brings RV cooking to another level. Light, fast, big and delicious. Less weight, higher quality.

- > High-quality materials and components
- > Contemporary, home-like design
- > Optimal use of space
- > Superior cooking performance



#### Specifications

12V spark ignition: Yes

Amount of burners: 4

Build-in dimensions (HxWxD): 312 x 496 x 493 mm

Door opening grill: Drop down

Electric hot plate (220-240V 50Hz): 1025 W Ø145 mm

Gas hot plate burners: 1x 0,95 kW 2x1,70 kW

Grill burner: 1,65 kW

Grill capacity: 15 L

Main dimensions (h x w x d): 310 x 515 x 501 mm

Pan rest: 1 piece Black Enamel

Total 230V power: 1025 W

Total heat input: 6,0 kW

Weight: 15.5 kg

## 700-04040

### TRIPLEX MK3 - DUAL FUEL

A compact combination stove, grill and oven that affords multi-function versatility in a durable, light-weight and easy to clean unit. Its main features include: flame failure device on valves, automatic shut off on glass, glass lid, oven shelf, multifunctional pan, detachable handle and pan trivet.



#### Specifications

Overall Dimensions: 468H x 456W x 500D (mm)

Enclosure Cut-Out Dimensions: 463H x 445W x 493D (mm)

Gas Hotplate Burners: 2 x 1.5kW

Electric Hotplate (220-240V, ~50Hz): 1000W

Oven Capacity: 36L

Net Weight: 23.1kg

**700-04058****TRIPLEX - GAS ONLY**

A compact combination stove, grill and oven that affords multi-function versatility in a durable, light-weight and easy to clean unit. Its main features include: flame failure device on valves, automatic shut off on glass, glass lid, oven shelf, multifunctional pan, detachable handle and pan trivet.

**NZ #700-90036****Specifications**

Overall Dimensions: 468H x 456W x 500D (mm)  
 Enclosure Cut-Out Dimensions: 463H x 445W x 493D (mm)  
 Gas Hotplate Burners: 2 x 1.5kW; 1 x 2.5kW  
 Oven Capacity: 36L  
 Net Weight: 25.5kg

**700-04070****OVEN AND GRILL MK3 - DUPLEX**

Enhance your kitchen with a Thetford combination oven and grill. They are made of high quality materials and components that are easy to use. Features include: piezo ignition, flame failure device on valves, oven shelf, multifunctional pan, detachable handle and pan trivet.

**NZ #700-90038****Specifications**

Overall Dimensions: 445H x 456W x 440D (mm)  
 Enclosure Cut-Out Dimensions: 438H x 445W x 490D (mm)  
 Oven Capacity: 36L  
 Net Weight: 13.5kg

**700-04100****ARGENT HOB MK3 - 3 BURNER**

The Argent Hob is a stainless steel hob with detachable pan stands, that are easy to clean and enamelled burner lids. Features include: flame failure device on valves, smoked black glass lid and automatic shut off on lid. Supplied with Piezo ignition.



**NOT**  
 AVAILABLE IN  
 NEW ZEALAND

**Specifications**

Overall Dimensions: 110H x 570W x 470D (mm)  
 Worktop Cut-Out Dimensions: 545W x 433D (mm)  
 Gas Hotplate Burners: 2 x 1.5kW; 1 x 2.5kW  
 Net Weight: 8.0kg

**700-04122****THETFORD SPINFLO K1520 ALL IN ONE FAN FORCE OVEN COOKTOP(3GAS + 1 ELC) + GRILL**

This all-in one combination cooker with 3 gas burners and 1 electric hotplate stove, grill and fan assisted oven brings RV cooking to another level. Light, fast, big and delicious. Less weight, higher quality.

- > High-quality materials and components
- > Contemporary, home-like design
- > Optimal use of space
- > Superior cooking performance

**Specifications**

12V spark ignition: Yes  
 Amount of burners: 4  
 Build-in dimensions (HxWxD): 640 x 496 x 493 mm  
 Electric hot plate (220-240V 50Hz): n.a.  
 Gas hot plate burners: 1x 0,95 kW / 3x 1,70 kW  
 Grill burner: 1,65 kW  
 Oven Burner: 1,75 kW  
 Oven capacity: 34 L  
 Overall dimensions (hxwxd): 645 x 515 x 501 mm  
 Pan rest: 1 piece  
 Total 230V power: 15 W Fan  
 Total heat input: 9.75 kW  
 Weight: 24.5 kg

# THETFORD COOKING APPLIANCES

## 700-04210

### TOPLINE HOB

A sleek, flush-mounting hob with a glass lid that covers burners for a clean look. It has an electric 12V DC ignition, a steel coated trim and frame. It also features: a flame failure device on valves, smoked black glass lid, flush bench top fitment and an automatic shut off on lid.



#### Specifications

**Overall Dimensions:** 105H x 546W x 482D (mm)  
**Worktop Cut-Out Dimensions:** 538W x 473D (mm)  
**Gas Hotplate Burners:** 2 x 1.5kW; 1 x 2.5kW  
**Net Weight:** 10.7kg

## 700-04551

### HOTPLATE, 2 BURNER AND GRILL

A fully self-enclosed, stand alone and portable gas stove, made out of high quality stainless steel. It features: a flame failure device on valves, a multifunction pan, a pan trivet, a detachable pan handle and a stainless steel lid.



#### Specifications

**Overall Dimensions:** 160H x 445W x 345D (mm)  
**Gas Hotplate Burners:** 2 x 1.5kW  
**Grill Burner:** 1.5kW  
**Net Weight:** 7.0kg

## 700-90010N

### NELSON MARINE COOKER

Suitable for the marine environment, the Marine Cooker features two gas burners, an open grill and oven. It is finished stylishly in stainless steel with a glass door.



#### Specifications

**Weight:** 19.1kg  
**Dimensions:** 525H x 450W x 420D (mm)

## 700-90028N

### THETFORD BASIC LINE 340 HOB

A stainless steel hob that has an electric (12V) spark ignition. The pan stands are easy to remove enabling easy cleaning. Features include: domestic style black knobs (40mm in diameter), 2 gas burners (1.5kW each) and 1 rapid burner (2.5kW). It has a flame failure device installed, along with a glass lid to maximise space when not being used.



#### Specifications

**Dimensions:** 100H x 540W x 445D (mm)  
**Cut Out Required:** 527W x 429D (mm)  
**Weight:** 5.6kg

## SPINFLO

## 700-90016N

A triangular stainless steel hob featuring a 12V spark ignition. It has detachable pan stands and the three burners have enamelled burner lids. Quality is uncompromised as this hob not only has easy to use domestic style knobs but the three burners are semi-rapid (1.5kW). A glass lid is attached to optimise bench top space. A left hand and right hand version is available (in reference to what side the glass lid is hinged).

#### Specifications

**External Dimensions:** 100H x 480W x 480D (mm)  
**Bench Top Cut Out:** 453W x 460D (mm)  
**Total Heat Input:** 4.5kW  
**Maximum Pan Sizes:** x2 200mm, x1 180mm  
**Gas Inlet Type:** Short, rear  
**Weight:** 4.1kg



## 700-90030N

### THETFORD TRIPLEX CARBON (WITH SEAL)

This combination stove, grill and oven, provides multi-function versatility in a durable, lightweight and easy-to-clean unit. It also features a stainless steel interior and is backed by a three year manufacturer's warranty.



#### Specifications

**External Dimensions:** 468H x 456W x 500D (mm)  
**Oven Capacity:** 36L  
**Oven Burner:** 1.6Kw  
**Stove Burners:** x2 1.8Kw, x1 2.4Kw  
**Weight:** 21.5kg

**700-9008N****SPINFLO 2 BURNER GRILL S/STEEL**

The Thetford Spinflo two burner hotplate comes supplied with pan supports and a grill pan, with each burner featuring individual controls and safeguarding flame failure devices.

**Specifications**

**Weight:** 6.5 kg

**Dimensions:** 445W x 345D x 160H (mm)

**700-90038****SPINFLO DUPLEX GRILL & OVEN NEW LOOK MIRROR - DUPLEX**

Enhance your kitchen with a Thetford combination oven and grill. They are made of high quality materials and components that are easy to use. Features include: piezo ignition, flame failure device on valves, oven shelf, multifunctional pan, detachable handle and pan trivet.

**Specifications**

**Overall Dimensions:** 445H x 456W x 440D (mm)

**Enclosure Cut-Out Dimensions:** 438H x 445W x 490D (mm)

**Gas Hotplate Burners:** 2 x 1.5kW; 1 x 2.5kW

**Oven Capacity:** 36Lt

**Net Weight:** 13.5kg

**THETFORD K1500 SERIES COOKERS**

These all-in-one combination units with stove, grill and oven offer you all the convenience to make the best meals.

**Features**

- > Flame failure device on valves
- > Glass lid with automatic shut off
- > Oven light, oven shelf
- > Multifunctional pan
- > Detachable handle and pan trivet

**Specifications**

**Overall dimensions (H x W x D):** 645 x 515 x 501 mm

**Enclosure cut-out dimensions (H x W x D):** 646 x 496 x 493 mm

**Total heat input:** 9.21kW

**Gas hotplate burners:** 1 x 0.89kW 3 x 1.72kW

**Electric hotplate (220 - 240V ~ 50Hz):** N/A

**Grill burner:** 1.65kW

**Oven burner:** 1.53kW

**Ignition:** 12V

**Oven capacity (H x W x D):** 34L 250 x 380 x 304 mm

**Grill capacity (H x W x D):** 15L 130 x 380 x 304 mm

**Net. weight:** 25Kg

**700-90060****THETFORD K1500 SERIES GAS COOKER STOVE - GAS 4 BURNER/GRILL/OVEN MIRROR FINISH****700-90064****THETFORD K1500 SERIES GAS COOKER STOVE- GAS 4 BURNER/GRILL/OVEN CARBON FINISH****700-90062****THETFORD K1500 SERIES GAS COOKER MINI GRILL - GAS 4 BURNER/GRILL MIRROR FINISH**

This compact grill and hob combination offers multi-function versatility in a durable, light-weight and easy-to-clean unit.

**Features**

- > Flame failure device on valves
- > Glass lid with automatic shut off
- > Multifunctional pan
- > Detachable handle and pan trivet

**Specifications**

**Overall dimensions (H x W x D):** 310 x 515 x 543 mm

**Enclosure cut-out dimensions (H x W x D):** 312 x 496 x 493 mm

**Total heat input:** 7.70kW

**Gas hotplate burners:** 1 x 0.89kW 3 x 1.72kW

**Electric hotplate (220 - 240V ~ 50Hz):** N/A

**Grill burner:** 1.65kW

**Ignition:** 12V

**Grill capacity (H x W x D):** 15L 130 x 380 x 304 mm

**Net. weight:** 25Kg

**700-91000N****THETFORD SEA RAIL & GIMBLE SET FOR NELSON COOKER**

Suited to the Nelson Marine Cooker. Sea rail and pot holders effectively limit your pot's movement whilst cooking.



# THETFORD COOKING APPLIANCES

**700-04014**

**THETFORD GLASS LID T/S  
CAPRICE/MINIGRILL MK3**

Replacement glass lid only to suit Thetford Caprice and Minigrill MK3.



**700-04612**

**THETFORD GRILL+HOB KNOBS T/S  
ALL SPINFLO UNITS**



**700-04052**

**THETFORD GLASS LID T/S TRIPLEX  
MK3**

Replacement glass lid only to suit Thetford Triplex MK3.



**700-04614**

**THETFORD SPINFLO 12V IGNITION  
SWITCH**



**700-04616**

**THETFORD CONTROL KNOB FOR  
SPINFLO MK3 OVEN ONLY**



**700-04224**

**THETFORD TOPLINE 902  
INDUCTION HOB 500 X 305  
2Z 230V-15AMP**

The Topline 902 is an induction hob developed and optimized for use in your caravan or motorhome including all safety and easy to use functionalities. Made from high quality Schott Ceran glass.

- > High-quality materials and components
- > Contemporary, home-like design
- > Optimal use of space
- > Superior cooking performance



**700-04012**

**THETFORD OVEN RACK T/S  
CAPRICE MK3**

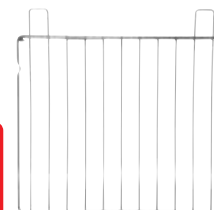

**Specifications**

**Hob material:** Black ceramic glas

**Induction zones:** 1 x 1.4 kW (1.8 kW Boost) / 1 x 1.8 kW (2.3 kW Boost)

**Knobs:** Touch controls

**Net weight:** 5.5 Kg

**Overall dimensions (hxwxd):** 53 x 305 x 500 mm

**Total heat input (electric):** 2.3 kW

**Total power use:** 230 V / 10 A

**Worktop cut-out dimensions (wxd):** 274 x 482 mm

**700-04610**

**THETFORD PIEZO IGNITOR  
FOR SPINFLO**



## COOKING APPLIANCES

## DOMETIC BURNER COOKTOPS

## 700-05163

**DOMETIC 2 BURNER COOKTOP  
FLUSH MT S/S C/W GLASS LID &  
12V IGN (480 X 370MM)**

Two burner gas stove with safety glass lid. Dometic's new and improved two burner stove has been purpose-built for excellent cooking performance. The unit features a durable safety glass lid, protecting the burners from any damage while not in use. The dual burners provide strong, reliable heat for all your cooking needs.

**Features**

- > Compact two-burner cooktop with improved efficiency.
- > 2 burners with a high combined heat output of 10.5MJ/h. The small left burner produces 4 MJ/h and the large right burner produces 6.5 MJ/hr.
- > Heat-resistant safety glass lid provides more workspace when closed.
- > Easy-to-clean detachable trivets
- > Stylish stainless-steel finish
- > Easy push button Piezo ignition

**Specifications**

Depth: 370 (mm)  
Height: 80 (mm)  
Width: 480 (mm)  
Net Weight: 3.58kg  
Output cooker plate 1: 1.1kW  
Output cooker plate 2: 1.8kW  
Burners: 2

## 700-05179

**DOMETIC 3 BURNER COOKTOP  
FLUSH MT S/S C/W GLASS LID &  
12V IGN (560 X 440MM)**

Three burner gas stove with safety glass lid. Dometic's new and improved three burner stove brings cooking convenience to small spaces while continuing to deliver an excellent cooking performance. The unit features a durable safety glass lid, protecting the burners from any damage while not in use. The three burners provide strong, reliable heat for all your cooking needs.

**Features**

- > Compact three burner cooktop with improved efficiency
- > 3 burners with a high combined heat output of 15.6 MJ/h (4MJ/h / 5.8MJ/h / 5.8MJ/h)
- > Heat-resistant safety glass lid provides more workspace when closed.
- > Easy-to-clean detachable trivets
- > Stylish stainless-steel finish
- > Easy push button 12V ignition

**Specifications**

Depth: 440 (mm)  
Height: 88 (mm)  
Width: 560 (mm)  
Net Weight: 5.3kg  
Output cooker plate 1: 1.1kW  
Output cooker plate 2: 1.6kW  
Output cooker plate 3: 1.6kW  
Burners: 3

## 700-05502

**NEW LIDO JUNIOR**

A sturdy and compact cooker with grill and brass burners. The body is stainless steel with a painted base and a hinged lid. Burners on the new Lido Junior have now been fitted with a flame failure device, making it suitable for use inside caravans, motorhomes etc. Requires a 5/16" SAE male gas connection.

**Specifications**

Weight: 3.6kg  
Dimensions: H175 x W480 x D290mm

## 700-05550

**HOSE 900MM T/S LIDO  
JUNIOR**



# COOKING APPLIANCES

## 700-05644

### DELUXE 2.0 STAINLESS STEEL BARBEQUE WITH HIGH LID & FLAME FAILURE

The latest addition to the Sizzler range now features a non-stick aluminium griller plate. As per the other Sizzlers, it too is totally windproof (being that the burners are sheltered in the cavity under the griller plate). Comes with a 1yr manufacturer's warranty.



#### Specifications

Closed Dimensions: 350D x 530W x 255H (mm) (including handle)

Plate Size: 430W x 250D (mm)

Burners: Two (stainless steel with piezo ignition)

Weight: 11.0kg

AGA Approval: Yes (5884)

## 700-05700

### SIZZLER BARBEQUE GAS HOSE WITH BAYONET FITTING

Suitable for use in RVs with a permanent gas flow system.



## 700-05702

### SIZZLER BARBEQUE STANDARD GAS HOSE AND REGULATOR KIT

Suitable for use when running a Sizzler Barbeque off a gas bottle.



## 700-05720

### SIZZLER BARBEQUE COOKING RACK TO SUIT ALL SIZZLER BARBEQUES

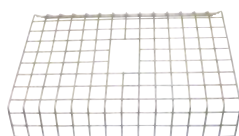

#### Specifications

Dimensions: 350W x 280L x 50H (mm)

## 700-05730

### SIZZLER BARBEQUE UTENSIL TRAYSUITABLE FOR USE ON ALL SIZZLER BARBEQUES

The utensil tray clips onto the front of the barbeque to hold your sauces or tongs.



## 700-05753

### SIZZLER BARBEQUE SLIDE KIT WITH QUICK RELEASE BRACKET

Suitable for use with the Sizzler Deluxe 2.0, the Slide Kit allows for installation (and storage) inside a cavity in your RV. By flicking the Quick Release Bracket, your barbeque can easily be dismounted for use in a different location.



## 700-05755

### SIZZLER BARBEQUE SWIVEL SLIDE KIT

Similar to slide kit above, the Swivel Kit allows for installations into a narrower cavity. To use the barbeque, simply rotate 90°.

*Note: BBQ not included*

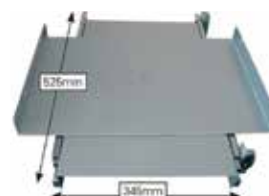

## SPHERE HOT POT ELECTRIC BBQ

700-05950

## SPHERE HOT POT ELECTRIC BBQ - 240VAC COMBO SKILLET

Enjoy delicious, impressive and healthy food with the two in 1 Sphere Hot Pot Electric BBQ.

The multipurpose design enables a variety of cooking methods for incredible cuisine.

Bring the best out of your ingredients with this truly versatile BBQ, it's great for meat, fish, vegetarian and vegan dishes.

The compact and sturdy design makes it a great choice to take caravanning and camping.



## Features

- > High-temperature non-stick surface that is durable and corrosion-resistant
- > 31x20.5cm Grill surface and 30 x 16.5cm Hot Pot
- > Separate precision temperature controls for BBQ plate and Hot Pot
- > The Hot Pot features 2 separate 1L sections for boiling.
- > Oil drain hole with removeable tray
- > Simple operation and easy to clean
- > Fast warm up for quick cooking

## Specifications

Dimensions: 45x13x33cm

Dimensions (Grill Surface): 31x20.5cm

Dimensions (Hot Pot): 30 X 16.5cm

Power: 1500w

Ac: 240v 50hz

Material: Die Casting Aluminium

Weight: 2.82kg

Oil Tray

Power Cord: 3g\*0.75mm<sup>2</sup>\*1.0m"

700-06052

## SPHERE™ MIRRORED MICROWAVE OVEN (25L)

Add convenience to your RV with the Sphere™ microwave oven, which now features a mesmerising mirror finish. With a large 25L oven capacity and five power level settings, it allows you to prepare a meal in no time! A digital control panel allows you to view and set your usage requirements, as well as display the ever handy clock. Defrosting frozen foods have been made easy as you're able to select whether you want to use speed or weight as the defrosting basis. It also features one-touch express cooking, a glass turntable (which is dishwasher safe), an end signal and a child safety lock. Aesthetically pleasing, the interior is a crisp white.



*Note: When installing a microwave, it must be placed on a flat and stable surface able to hold the weight of the microwave. You should always cover your food whilst cooking as it prevents spattering and also helps to cook the food evenly.*

## Specifications

Output Power: 900W

Door Open: Push button

Net Weight: 13.9kg

Dimensions: 281H x 490W x 396D (mm)

Voltage: 230 - 240V

Frequency: 50Hz

700-06154

## MICROWAVE OVEN GLASS TURNTABLE

T/S Microwave Oven 25L 900W



700-06150

## MICROWAVE OVEN CONNECTOR T/S MICROWAVE OVEN 25L 900W



# MY COOLMAN FRIDGES

## MY COOLMAN FRIDGES



myCOOLMAN® fridges are equipped to come where the road takes you. Keep your food fresher longer with cutting-edge cooling tech and rule your campsite with our genius quality of-life features. Only you decide when it's time to head out, or pack up.

Powerful, robust and ready for any adventure, myCOOLMAN® fridges and freezers bring freshness to the Australian bush. Designed and engineered in Germany to suit the demanding Australian conditions, myCOOLMAN® offers versatility with a range of practical features and sophisticated technology for everyone who loves life off the beaten track. Ranging in sizes from 36 to 105 litres with single and dual zone models, cooling and freezing food of all kinds is a breeze with reliability down to minus 18 degrees.

Packaged in a sturdy transport bag, chilled goods are protected even if no power is available at short notice. Access to the contents is easy thanks to Velcro fasteners. Even when packaged, full operation of the cooler is guaranteed via visible display control and app. The bags are of course available for all box sizes. The pockets on it are very practical for cutlery, tools and the other little things that are helpful in the outback.

### FEATURES

- > **Technology** - Digital display & USB port and charger with 3000mMulti-voltage system AC (240V) and DC (12/24V) with battery protection DC inlet on two ends.
- > **Multi-functional lid** - Two way opening lid (not CCP36/44) & headroom for upright standing bottles.
- > **Compressor power** - Powered by 12/24 Volt DC compressor helping you keep items cooler for longer.
- > **LED Lighting** - LED interior light to help see items in your fridge at any time of day or night.
- > **Dual Storage** - Divided storage options with removable sections & fully refrigerated multi-level compartment.

### 700-20000

#### MY COOLMAN 36L PORTABLE FRIDGE & FREEZER - 12/24V & 240V

CCP 36 Single Zone \*



### Specifications

Dimensions(mm): L652 W412 H428  
 Weight(kg): 18  
 Volume(L): 36  
 Current: 12V-3.40A / 24V-1.70A / 240V-0.44A  
 Refrigerant / Quantity R134a / 43g



## MY COOLMAN FRIDGES

**700-20002****MY COOLMAN 44L  
PORTABLE FRIDGE &  
FREEZER - 12/24V & 240V**

CCP 44 Single Zone \*

**Specifications**

Dimensions(mm): L652 W412 H488  
 Weight(kg): 20.5  
 Volume(L): 44  
 Current: 12V-3.80A / 24V-1.90A / 240V-0.30A  
 Refrigerant / Quantity R134a / 45g

**700-20008****MY COOLMAN 69L  
PORTABLE FRIDGE &  
FREEZER (DUAL ZONE) -  
12/24V & 240V**

CCP 69 Single Zone \*

**Specifications**

Dimensions(mm): L732 W456 H555  
 Weight(kg): 27.2  
 Volume(L): 69 (24/45)  
 Current: 12V-5.30A / 24V-2.80A / 240V-0.31A  
 Refrigerant / Quantity R134a / 75g

**700-20004****MY COOLMAN 60L  
PORTABLE FRIDGE &  
FREEZER - 12/24V & 240V**

CCP 60 Single Zone \*

**Specifications**

Dimensions(mm): L732 W456 H488  
 Weight(kg): 23.5  
 Volume(L): 60  
 Current: 12V-5.60A / 24V-2.90A / 240V-0.30A  
 Refrigerant / Quantity R134a / 65g

**700-20010****MY COOLMAN 96L  
PORTABLE FRIDGE &  
FREEZER (DUAL ZONE) -  
12/24V & 240V**

CCP 96 Single Zone \*

**Specifications**

Dimensions(mm): L912 W536 H500  
 Weight(kg): 31.8  
 Volume(L): 96 (41/55)  
 Current: 12V-5.80A / 24V-2.90A / 240V-0.34A  
 Refrigerant / Quantity R134a / 96g

**700-20006****MY COOLMAN 73L  
PORTABLE FRIDGE &  
FREEZER - 12/24V & 240V**

CCP 73 Single Zone \*

**Specifications**

Dimensions(mm): L732 W456 H555  
 Weight(kg): 25  
 Volume(L): 73  
 Current: 12V-5.90A / 24V-3.00A / 240V-0.30A  
 Refrigerant / Quantity R134a / 70g

**700-20012****MY COOLMAN 105L  
PORTABLE FRIDGE &  
FREEZER - 12/24V & 240V**

CCP 105 Single Zone \*

**Specifications**

Dimensions(mm): L912 W536 H500  
 Weight(kg): 28.6  
 Volume(L): 105  
 Current: 12V-5.50A / 24V-2.80A / 240V-0.32A  
 Refrigerant / Quantity R134a / 100g

# RVX FRIDGE FREEZERS

## RVX FRIDGE FREEZERS



The new range of portable fridges that take comfort to a new level.

Sphere RVX fridge/freezers are available in six models to suit most needs and budgets. They are the perfect way to take a little bit of the comfort and convenience of home with you on all your camping and RV adventures.

Offered in two distinct styles, the skillfully designed End or Side Opening lid can be lifted from either side or removed completely in one simple motion.

### Benefits

- > The RVX range features an LED display and push button controls so you can easily and accurately adjust and monitor your fridges temperature.
- > The robust and refined cabinet utilizes a polypropylene construction with reinforced corners making it strong and easy to keep clean.
- > The fully insulated cabinet and lid will keep your food and drinks cold and fresh during the hottest Australian summers.
- > Fold away carry handles make storing and lifting the fridge a breeze while offering a convenient point to secure the fridge while traveling.
- > An internal LED light that switches on when the lid is open ensures you will always be able to see what you're looking for.
- > A removable internal basket and separate dairy compartment allows you to organise your fridge how you like and easily clean and maintain it.
- > The entire RVX range comes with a protective cover as standard to help you protect your investment.
- > 3 Year Warranty plus Additional 2 Year Parts Only Compressor Warranty.

### 700-22080

#### SPHERE RVX-35 FRIDGE/ FREEZER

#### Specifications

**Capacity:** 35L  
**Dimensions (mm):** 677L x 410W x 439H  
**Weight:** 18.7kg  
**Lid Opening:** End  
**Voltage:** Operates on both DC 12V/24V and AC 240V  
**Temperature Range:** -22°C ~ 10°C  
**Compressor:** SECOP compressor  
**Materials:** Polypropylene with Polyurethane Insulation  
**Cooling Capacity:** 55° Below Ambient  
**Average Power Draw at 32°C ambient and 5°C internal:** Less than 1.0 A/HR



## RVX FRIDGE FREEZERS

**700-22082****SPHERE RVX-45 FRIDGE/  
FREEZER****Specifications**

Capacity: 45L

Dimensions (mm): 677L x 410W x 489H

Weight: 19.8kg

Lid Opening: End

Voltage: Operates on both DC 12V/24V and AC 240V

Temperature Range: -22°C ~ 10°C

Compressor: SECOP compressor

Materials: Polypropylene with Polyurethane Insulation

Cooling Capacity: 55° Below Ambient

Average Power Draw at 32°C ambient and 5°C internal: Less than 1.0 A/HR

**700-22086****SPHERE RVX-55 FRIDGE/  
FREEZER****Specifications**

Capacity: 55L

Dimensions (mm): 709L x 455W x 498H

Weight: 24.4kg

Lid Opening: Side

Voltage: Operates on both DC 12V/24V and AC 240V

Temperature Range: -22°C ~ 10°C

Compressor: SECOP compressor

Materials: Polypropylene with Polyurethane Insulation

Cooling Capacity: 55° Below Ambient

Average Power Draw at 32°C ambient and 5°C internal: Less than 1.0 A/HR

**700-22088****SPHERE RVX-65 FRIDGE/  
FREEZER****Specifications**

Capacity: 65L

Dimensions (mm): 709L x 455W x 558H

Weight: 25.5kg

Lid Opening: Side

Voltage: Operates on both DC 12V/24V and AC 240V

Temperature Range: -22°C ~ 10°C

Compressor: SECOP compressor

Materials: Polypropylene with Polyurethane Insulation

Cooling Capacity: 55° Below Ambient

Average Power Draw at 32°C ambient and 5°C internal: Less than 1.0 A/HR







# SECTION 7

## PLUMBING

(Product Group - 800)

Shurflo Pumps and Parts	255 - 260
Lockable Water Fillers	261 - 262
Waste Hose and Drinking Hose	263 - 264
Water Tanks	265 - 267
JG Plumbing Fittings	267 - 272
Plastic Plumbing Fittings	272 - 275
Fuel Safe Cans	276
Accumulator Tanks	276
Tank Monitors and Cleaners	276 - 277
Thetford Sinks, Smev Sinks and Ceramic Sinks	277 - 280
Shower Hoses, Mixers and Hand Pumps	280 - 281
Faucets	282 - 283
Coast Bathroom Accessories	284

## TOILETS

(Product Group - 850)

Fiamma Bipots and Thetford Porta Pottis	285 - 286
Thetford Additives Cleaners	287 - 290
Toilet Tissue	290
Thetford Cassette Toilets	291 - 292
Thetford Toilet Accessories and Spares	293 - 294
Valterra Hoses, Valves and Fittings	294 - 295
Camco Sewer Fittings and Hoses	296 - 297
Fiamma Tanks	297
Caravan Loo Treatment	298
Toilet Deodorisers	299 - 300



## SHURFLO PUMPS



Since 1968, SHURFLO® emerged to set the standard for all freshwater pumps throughout the RV Industry. Used worldwide, SHURFLO® pumps quickly earned the reputation of being the most reliable on the market.

**800-00012**  
**SHURFLO PUMP 12V (10L,**  
**OEM BULK,**  
**NO FITTINGS)**

A fresh water pump designed with a one-piece diaphragm and internal by-pass ensuring a long life and max performance. Constructed for high flow demand, this updated Shurflo pump has low noise emissions and no rapid cycling. CE and C-Tick compliant, must be installed with a filter.



**Specifications**

**Pump**

Type: 4 Chamber Diaphragm Pump

Ports: 1/2" - 14 NPSM-Male

Inlet PSI: 30Psi (2.1Bar) Max

Shut Off Pressure: 45Psi

**Electrical**

Motor: 12V DC Permanent Magnet, Intermittent Duty

Protection: Thermal Overload, Automatic Restart

Fuse: 7A Recommended

**Materials**

Housing: Polypropylene

Hardware: Stainless and Zinc Plated Steel

Net Weight: 2.3kg

Dimensions: 205L x 125W x 111H (mm)

**800-99997**  
**SHURFLO 4009 OEM PUMP 12V AND FILTER KIT**

Includes x1 800-00012 and x1 800-00300

**800-00022**  
**SHURFLO 4009 PUMP (10L,**  
**RETAIL BOX)**

Has all the same features and functions as 800-00012 (above) with the only difference being that it comes in a well presented retail box with fittings for display on your shelves. The Retail Box comes with x2 800-00206 fittings for your customers' convenience.



Note: A filter must be installed with the 4009 Pump in order to validate warranty.



**800-99998**

**SHURFLO 4009 RETAIL PUMP 12V AND FILTER KIT**

Includes x1 800-00022 and x1 800-00300

**800-00052**

**SHURFLO 4009 PUMP  
24V (10L OEM BULK, NO  
FITTINGS)**

Has all the same features and functions as 800-00012 with the only difference being that it runs on 24VDC. Note: A filter must be installed with the 4009 Pump in order to validate warranty.



**Specifications**

**Pump**

Type: 4 Chamber Diaphragm Pump

Ports: 1/2" - 14 NPSM-Male

Inlet PSI: 30Psi (2.0Bar) Max

Shut Off Pressure: 30Psi

**Electrical**

Motor: 24V DC Permanent Magnet, Intermittent Duty

Protection: Thermal Overload, Automatic Restart

Fuse: 5A Recommended

**Materials**

Housing: Polypropylene

Hardware: Stainless and Zinc Plated Steel

Net Weight: 2.5kg

Dimensions: 205L x 125W x 111H (mm)

**800-00070**

**SHURFLO 30PSI 12V PUMP BULK**

Shurflo's 4009 series fresh water pump design was created with a unique one-piece diaphragm and internal by-pass, assuring long life and top performance. The 4009 series pump is constructed for high flow demand, low noise and no rapid cycling. The 4009 series fresh water automatic demand pump is super quiet, thermally protected and can run dry without damage. Note: A filter must be installed with the 4009 pump in order to validate warranty.

**Specifications**

**Pump**

Type: 4 Chamber Diaphragm Pump

Ports: 1/2" - 14 NPSM-Male

Inlet PSI: 30Psi (2.1Bar) Max

Shut Off Pressure: 30Psi

**Electrical**

Motor: 12V DC Permanent Magnet, Intermittent Duty

Protection: Thermal Overload, Automatic Restart

Fuse: 5A Recommended

**Materials**

Housing: Polypropylene

Hardware: Stainless and Zinc Plated Steel

Net Weight: 2.3kg

Dimensions: 205L x 125W x 111H (mm)

**800-00072**

**SHURFLO 30PSI 12V PUMP  
RETAIL BOX**

Has all the same features and functions as 800-00070 with the only difference being that it comes in a well presented retail box with fittings. This retail box also contains all the necessary fittings for installation, however please note, a filter must be installed with the 4009 pump in order to validate warranty.



**SHURFLO 2088 REPLACEMENT PARTS**

**800-00150**

**REPLACEMENT VALVE ASSEMBLY KIT**



**800-00154**

**REPLACEMENT CHECK VALVE  
KIT**



**800-00156**

**REPLACEMENT LOWER HSG/DRIVE KIT**



**800-00158**

**REPLACEMENT UPPER HSG/SWK KIT  
40PSI**



**SHURFLO 4009 REPLACEMENT PARTS**

**800-00160**  
**REPLACEMENT UPPER ASSEMBLY #1**



**800-00162**  
**REPLACEMENT VALVE ASSEMBLY #2**



**800-00164**  
**REPLACEMENT DRIVE ASSEMBLY #3**

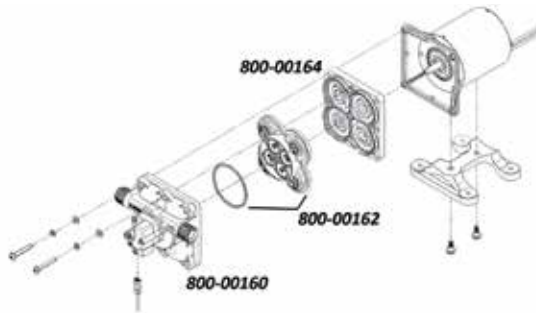

**800-00170**  
**SHURFLO PRESSURE SWITCH**  
To suit 4009-101-A87/B87.94-890-02



**800-00172**  
**SHURFLO UPPER ASSEMBLY #1**  
To suit 4009-131-A54 24V pump



**SHURFLO BARBS**

**800-00200**  
**ELBOW BARB WITH 1/2" TAIL (90°)**



**800-00202**  
**STRAIGHT BARB WITH 1/2" TAIL**



**800-00204**  
**ELBOW 1/2" THREAD INLET AND OUTLET**



**800-00206**  
**STRAIGHT WINGNUT WITH 3/4" BARB**



**FILTERS**

These clear strainers eliminate unnecessary repair by keeping dust or other particles out of your Shurflo pump. Its transparent design is also convenient as it shows when the filter should be cleaned/ emptied. The top housing is made from polypropylene and the filter itself is made from T304 stainless steel (mesh). Note that for warranty purposes, all Shurflo pumps must be installed with one of the two filters below.

**800-00300**  
**TWIST FILTER WITH 1/2"THREAD INLET AND OUTLET**

This is a direct screw on filter and will require a screw-on connection.



**800-00312**  
**TWIST-ON FILTER WITH 1/2" BARB INLET**

Suitable for use when a flexible hose such as a reinforced drink water hose is used.



## IN LINE CHECK VALVES

**800-00340**  
**SHURFLO IN LINE CHECK VALVE WITH 1/2" BARBS**



**800-00350**  
**WHALE 1/2 PLASTIC IN LINE NON RETURN VALVE**



## SHURFLO WATER PRESSURE REGULATORS

**800-00502**  
**SHURFLO IN-LINE PRESSURE WATER REGULATOR (WHITE)**  
A water pressure reducing valve; outlet pressure: 50psi; inlet pressure: 125psi (max)



**800-00520**  
**SHURFLO CITY WATER PRESSURE REGULATOR FLUSH MOUNT (POLAR WHITE)**



**800-00529**  
**PRESSURE LIMITING VALVE 350KPA**



**800-00532**  
**SHURFLO FLUSH MOUNT WATER PRESSURE REGULATOR - BLACK**



**800-00550**  
**COAST 90D ELBOW HOSE ADAPTER 1/2" MPT TO CLICK ON**

This quick click on hose connector has an American thread to fit properly into a Shurflo city water entry, with an elbow to prevent hose kinking.



**800-00552**  
**VALTERRA MALE HOSE MENDER**  
Adapter to suit USA thread.



**800-00600**  
**SHURFLO RV AND MARINE FILTRATION KIT (RV-QBR-A)**

Using only the highest quality approved materials, the Shurflo Filtration Kit ensures you have clean, great tasting water wherever you travel. It actively reduces the chlorine taste and odour from water. The kit includes a 1/4" filter head (with bracket), a disposable filter, a drinking water tap, mounting screws, mounting fittings and a 1.5m length of tube. Suitable for cold water only, it is recommended that after prolonged periods of non-use, that the system be flushed thoroughly i.e. let water run for 2-3 minutes before using it. When mounting the system, allow 1 1/2" (38mm) clearance below the housing or 279mm below the filter head (this will give you enough room to change the filter cartridges). Comes with a limited 1yr warranty from Pentair Water Australia.



### Specifications

Micron: 0.5  
Pressure Range: 30 - 125 PSI (2.1 - 8.62 Bar)  
Flow Rate: 1.9L p/min

**800-00650**  
**SHURFLO REPLACEMENT CARTRIDGE FOR FILTER KIT (RV-QDFR-A)**

Easily installed, the disposable quick change filter ensure you have pure water for longer. Shurflo recommends changing the filter every 6 - 12 months or when its capacity (1890L) has been reached, whichever comes first. (Alternative model number: 155 785-38)



## SHURFLO PUMP FACTS

## MAINTENANCE

Checking and cleaning the strainer, normal sanitizing and winterizing and occasional checking all plumbing hardware and fittings for tightness is all that is normally required. Lack of sanitizing is the number one reason for premature pump failure and poor performance over time. Lack of sanitizing will cause scale build-up on the diaphragm and valves, causing low flow and leak back (occasionally pump cycling with no faucets open or tank filling up when hooked up to city water).

## SANITIZING

Potable water systems require periodic maintenance to keep components working properly and deliver a consistent flow of fresh water. Sanitizing is recommended: prior to storing, after a period of storage, or any time the system is opened or contaminated, as follows: NOTE: Check your Vehicle Owner's Manual for specific instructions. By-pass any filters or remove filter cartridges.

1. Determine the amount of common household bleach needed to sanitize the tank. 1 ml bleach per 1 liter tank size: 300 liter tank = 300 milliliters of bleach.
2. Mix the bleach with water in a container such as a gallon jug. If tank is filled through a pressurized fitting, pour the bleach into the hose before attaching the hose to the city water entry.
3. Pour the bleach solution into the tank and fill the tank with potable water. Rock the RV back and forth to coat top and sides of potable water tank.
4. Open all faucets (Hot & Cold) allowing the water to run until the odor of chlorine is detected. Allow four (4) hours of contact time to disinfect completely. Doubling the solution concentration allows for a contact time of one (1) hour.
5. Drain the tank. Refill the tank and flush the system once or twice until the odor has decreased. The residual chlorine odor and taste is not harmful.

## WINTERIZING

**Refer to the vehicle owner's manual for specific winterizing instructions.**

If water is allowed to freeze in the system, serious damage to the plumbing and pump may occur. Failures of this type will void the warranty. The best guarantee against damage is to completely drain the pump and perform the following:

1. Drain the water tank. If the tank doesn't have a drain valve, open all faucets allowing the pump to operate until the tank is empty.
2. Open all the faucets (including the lowest valve or drain in the plumbing), allow the pump to purge the water from the plumbing, and then turn the pump OFF.
3. Using a pan to catch the remaining water, remove the plumbing at the pump's inlet/outlet ports. Turn the pump ON, allowing it to operate until the water is expelled. Turn OFF power to the pump once the plumbing is emptied. Do not reconnect the pump plumbing. Make a note at tank filler as a reminder: "Plumbing is disconnected".
4. All faucets must be left open to guard against any damage.
5. Potable anti-freeze may be poured down drains and toilets to protect

p-traps and toilet seals. Sanitize the plumbing system before putting the plumbing system back in service.

PUMP W/ ADJUSTABLE  
PRESSURE SWITCH  
"OPERATION"

Restrictions in a plumbing system may cause the pump to rapid cycle (ON/OFF within 2 sec.) during low flow demands. Cycling should be minimized to prevent pulsating flow and to achieve maximum pump life. To determine if adjustment is necessary, turn tap on to lower than average flow of water. The pump should cycle, but its "OFF time" must be 2 seconds or longer. If the cycling is correct, leave well enough alone. If the pump is cycling rapidly increase the setting by turning the screw clockwise (1/2 TURN to . TURN MAX.) until the pump operates for 1 second with at least 2 seconds "OFF time". If cycling cannot be minimized consider removing plumbing restrictions or simply install a SHURFLO Accumulator.

PUMP W/ ADJUSTABLE BYPASS  
& ADJUSTABLE PRESSURE  
SWITCH "OPERATION"

The pump operates normally up to about 1 Bar [15 psi] by-pass pressure, where a spring-loaded by-pass valve opens, allowing flow back from the output side to the input side, providing smooth, steady flow with virtually no cycling, all the way down to a trickle. As a faucet is opened, the pressure will drop, the by-pass will close and full flow is achieved. This allows good flow, even with today's commonly used restrictive showers and pullout sprayer faucets. Performance will vary, of course, depending on the voltage to the pump: lower voltage = lower flow, higher voltage = higher flow. Always be cautious and practice electrical safety. It is always best to shut off power to the pump when leaving the RV/Caravan unattended.

## ABOUT THE BY-PASS

The by-pass is a spring-loaded diaphragm that, when open allows water from the discharge side back to the inlet side. If the switch or by-pass are adjusted too much, the by-pass and switch shut-off can overlap and THE PUMP WILL NOT SHUT OFF. Screwing the switch screw in clockwise will raise the shut-off pressure. Unscrewing the switch screw counter clockwise will lower the pump shut-off pressure. Screwing the by-pass screw in will raise the pressure at which the by-pass starts and raise the full by-pass pressure. Unscrewing the by-pass screw counter clockwise will lower the pressure at which by-pass starts and lower the full by-pass pressure.

**WARNING: If full by-pass is reached before the shut-off setting, the pump will not shut off .**

Full by-pass pressure setting should be at least 0.48 bars [7 psi] higher than pump shut off pressure.

## TROUBLESHOOTING

Vibration induced by driving can loosen plumbing, strainers and pump hardware.

Check for system components that are loose. Also, refer to the chart below for trouble-shooting tips.

PUMP WILL NOT START/ BLOWS  
CIRCUIT

- > Electrical connections, fuse or breaker, main switch, and ground connection.

- > Is the motor hot? Thermal breaker may have triggered; it will reset when cool.
- > Is voltage present at the switch? Bypass pressure sw. Does the pump operate?
- > Charging System for correct voltage (10%) and good ground.
- > For an open or grounded circuit, or motor; or improperly sized wire.
- > For seized or locked diaphragm assembly (water frozen?).

## WILL NOT PRIME/SPUTTERS

(No discharge/Motor runs)

- > Is the strainer clogged with debris?
- > Is there water in the tank, or has air collected in the hot water heater?
- > Is the inlet tubing/plumbing sucking in air at plumbing connections (vacuum leak)?
- > Is inlet/outlet plumbing severely restricted or kinked? Restrictive valves?
- > Proper voltage with the pump operating ( >10%).
- > For debris in pump inlet/outlet valves or swollen/dry valves.
- > Pump housing for cracks or loose drive assembly screws.

## RAPID CYCLING

- > For restrictive plumbing and flow restrictions in faucets/shower heads.
- > Water filter/purifier should be on separate feed line.
- > Shut-off pressure set too low.

## PUMP WILL NOT SHUT-OFF / RUNS WHEN NOZZLE IS CLOSED

- > Output side (pressure) plumbing for leaks, and inspect for leaky valves or toilet.
- > For air trapped in outlet side (water heater) or pump head.
- > For correct voltage to pump ( >10%).
- > For loose drive assembly or pump head screws.
- > Are the valves held open by debris or is the rubber swollen?
- > Pressure switch operation. By-pass set higher than shut-off.

## NOISY OR ROUGH OPERATION

- > For plumbing which may have vibrated loose.
- > For a restricted inlet (clogged strainer, kinked hose, restrictive valves).
- > Is the pump plumbed with rigid pipe causing noise to transmit?
- > Does the mounting surface amplify noise (flexible)? Does it bang like a drum?
- > For mounting feet that are loose or are compressed too tight.
- > For air in the system. Check all fixtures for air and bleed system.
- > The motor with pump head removed.

Is noise from motor or pump head?

## LEAKS FROM PUMP HEAD OR SWITCH

- > For loose screws at switch or pump head.
- > Switch diaphragm ruptured or pinched.
- > For punctured diaphragm if water

## LOCKABLE WATER FILLERS

**800-00900**

**LOCKABLE WATER FILLER  
COMPLETE WITH CAP  
AND KEYS "WHITE" 25MM  
OUTLET**



**800-00902**

**LOCKABLE WATER FILLER  
WITH 25MM OUTLET,  
COMPLETE WITH CAP -  
BLACK**



**800-00920**

**SPARE CAP AND KEYS ONLY  
"WHITE"**



**800-00922**

**SPARE CAP AND KEYS  
- BLACK ONLY**



**800-01063**

**WATER FILLER CAP (BLACK)**

Lockable, comes with two keys.



**800-01064**

**WATER FILLER CAP (WHITE)**

Lockable, comes with two keys.



# LOCKABLE WATER FILERS

800-01000

AC41 WATER FILLER WITH LID



## SQUARE LOCKABLE WATER FILLER

800-01081

DUAL LOCKABLE WATER FILLER WITH PLASTIC VALVE



### Specifications

Dimensions Overall: 195W x 167H x 47D (mm)

Dimensions Cut Out: 147W x 118H (mm)

800-01082

SPARE KEY TO SUIT DUAL LOCKABLE WATER FILLER

Also suits external shower unit  
800-06000 and 800-06002

800-01088

WATER FILLER INLET (BLACK)

### Specifications

Dimensions: 230W x 153H x 83D (mm)



800-01090

WATER FILLER INLET (WHITE)

### Specifications

Dimensions: 230W x 153H x 83D (mm)



800-01110

WATER FILLER LOCKABLE

Accepts a 32mm or 35mm hose and has a tank vent connection. Is UV and impact resistant and can be painted if required.



### Specifications

Dimensions Overall: 165H x 152W x 76D (mm)

Dimensions Cut Out: 121H x 108W (mm)

800-01091

DOOR SET FOR WATER FILLER INLET



800-01092

INLET CONNECTOR FOR WATER FILLER



800-01096

KEYS (PAIR) ONLY (PLASTIC) FOR WATER FILLER



## CAMCO TASTE PURE IN-LINE WATER FILTER

800-01200

RV MARINE WATER FILTER

Safe Water Matters

Camco's TastePURE RV/Marine Water Filter with Flexible Hose Protector reduces bad taste, odor, chlorine and sediment in drinking water with a 20-micron sediment filter. Also features GAC (Granular Activated Carbon) filtration in combination with KDF to prevent undesirable bacteria growth when the filter is not in use. Durable in-line, exterior mount filter has a wide body for increased flow. Includes bonus quick change hose fittings. Not designed or tested with fish tanks or ponds. Made in the USA.



### Protects against:

- > Bad Tastes
- > Odours
- > Sediments
- > Bacteria
- > Chlorine
- > Made in the USA

Flush RV or Marine water system by allowing tap to run several minutes if system has not been used recently. We recommend always using a water pressure regulator.

### Filter Life / Replacement

Filter life depends on water quality. Replace when an undesirable taste or odor appears or if water flow decreases significantly.



**800-01230**

**MARINE AND OUTDOOR WATER HOSE**

A 10m drink water hose supplied on a manually retractable hose reel. Great for any RV, the hoses' reinforced core ensures continuous water flow. Compact in design (just 1.59cm wide), it has a carry handle for portability. (The hose comes standard with a 3/4" BSP threaded connection. Should this type of thread not be suited to your needs, an Adaptor Kit can be purchased - (refer to part number 800-01241 below)



**Specifications**

Dimensions: 1.59W x 1000L (cm)

**800-01290**

**FLAT OUT 9M WASTE HOSE 32MM ID (ON MULTI-REEL)**

*\* Empty reels also available, please refer to Section 3*



**Specifications**

Dimensions: 375W x 440H (mm)

**DRINKING WATER HOSE (WHITE)**

**800-01300**

**WHITE NON-TOXIC REINFORCED WATER HOSE (12MM X 20M)**



**800-01310**

**WHITE NON-TOXIC REINFORCED WATER HOSE (12MM X 10M)**



**FLAT-OUT HOSES**

**800-01250**

**FLAT OUT 15M DRINK HOSE 25MM ID (ON MULTI-REEL)**



**Specifications**

Dimensions: 375W x 440H (mm)

**800-01260**

**FLAT OUT 10M DRINK HOSE 25MM ID (ON COMPACT REEL)**



**Specifications**

Dimensions: 300W x 360H (mm)

**BLACK WASTE HOSE 25MM ID**

Corrugated flexible hose, tough and durable waste hose with a "smooth" inner lining to prevent clogging available in 10m or 30m rolls with a 25mm ID diameter.

**800-01332**

**10M ROLL BLACK WASTE HOSE 25MM ID**



**800-01342**

**30M ROLL BLACK WASTE HOSE 25MM ID**



**800-01270**

**FLAT OUT 9M WASTE HOSE 25MM ID (ON MULTI-REEL)**

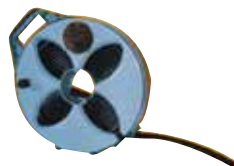

**Specifications**

Dimensions: 375W x 440H (mm)

**800-01280**

**FLAT OUT 6M WASTE HOSE 25MM ID (ON COMPACT REEL)**



**Specifications**

Dimensions: 300W x 360H (mm)

## WASTE AND DRINKING HOSES

**BLACK WASTE HOSE 27MM ID**

Corrugated flexible hose, tough and durable waste hose with a "smooth" inner lining to prevent clogging available in 10m or 30m rolls with a 27mm ID diameter.

**800-01334**  
**10M ROLL BLACK WASTE HOSE**  
**27MM ID**



**800-01344**  
**30M ROLL BLACK WASTE**  
**HOSE 27MM ID**

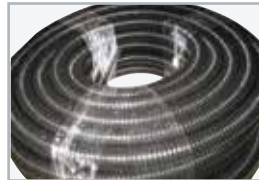

**800-01336**  
**BLACK WASTE HOSE**  
**38MM ID**

A smooth bore (inner lining) waste hose made from black PVC. It has great flexibility and is UV stabilised. Comes in a 10m roll.

**Specifications**

Nom O.D.: 45mm

Vacuum Rating: 310mm hg (@20°C)

Min. Bend Radius: 140mm

**800-01346**  
**BLACK WASTE HOSE 32MM ID**

A smooth bore waste hose made from black PVC. It has great flexibility and is UV stabilised. Comes in a 10m roll.

**Specifications**

Nom O.D.: 39mm

Vacuum Rating: 310mm hg (@20°C)

Min. Bend Radius: 115mm

**800-01360**  
**20M ROLL OF NON-TOXIC**  
**REINFORCED WATER HOSE**

A blue 20m plastic wrapped hose suitable for multiple applications, especially in caravans and boats. Can also be used with a standard 12mm garden hose fitting.

**Specifications**

Pressure Rating: 12.5PN

**800-01362**  
**10M ROLL OF NON-TOXIC**  
**REINFORCED WATER HOSE**

A blue 10m plastic wrapped hose suitable for multiple applications, especially in caravans and boats. Can also be used with a standard 12mm garden hose fitting.

**Specifications**

Pressure Rating: 12.5PN

**800-01364**  
**100M COIL OF NON TOXIC**  
**REINFORCED WATER HOSE**

A blue 100m plastic wrapped hose suitable for multiple applications, especially in caravans and boats. Can also be used with a standard 12mm garden hose fitting.

**Specifications**

Pressure Rating: 12.5PN

**800-01366**  
**12MM WHITE NON TOXIC**  
**WATER HOSE WITH FITTINGS**  
**10M**

12mm hose for the conveyance of drinking water, comes with fittings installed.

- > Proudly Australian made.
- > Conforms to AS/NZS 2070 (Plastics for food contact).
- > Excellent U.V. resistance to withstand extreme Australian conditions.
- > Manufactured from Phthalate free compound.
- > Specially manufactured as to not taint the water.

**Specifications**

**Inner Core:** White non tainting Polyolefin with smooth finish.

**Reinforcing:** High tenacity polyester yarn.

**Outer Cover:** U.V. stabilised clear Polyolefin with a smooth finish.

**Fittings:** Fitted with Perma-connect fittings c/w tap adaptor.

**800-01500**  
**ALKO TANK**  
52L Alko tank

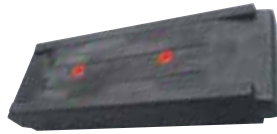

**Specifications**

Dimensions: 1000mm x 330mm x 178mm

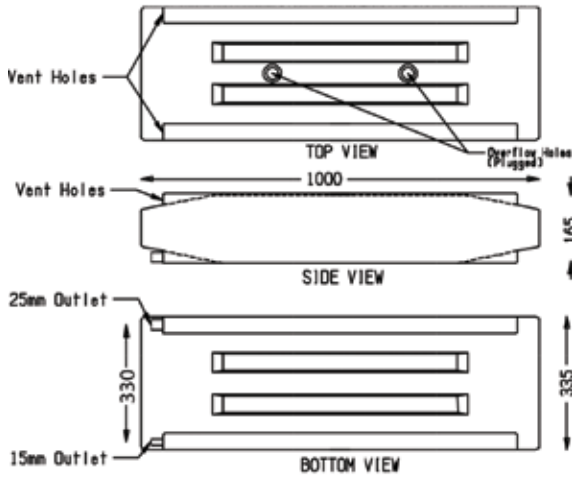

**800-01530**  
**MILLARD TANK**  
63L Millard tank



**Specifications**

Dimensions: 860mm x 525mm x 160mm

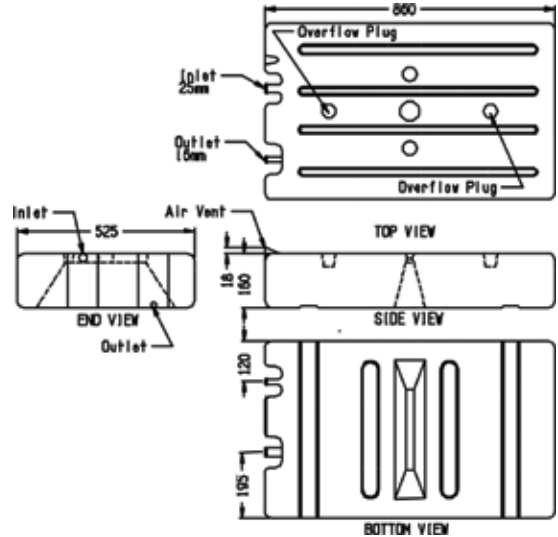

**800-01520**  
**ROUND ENDED TANK**  
61L round ended tank



**Specifications**

Dimensions: 900mm x 490mm x 165mm

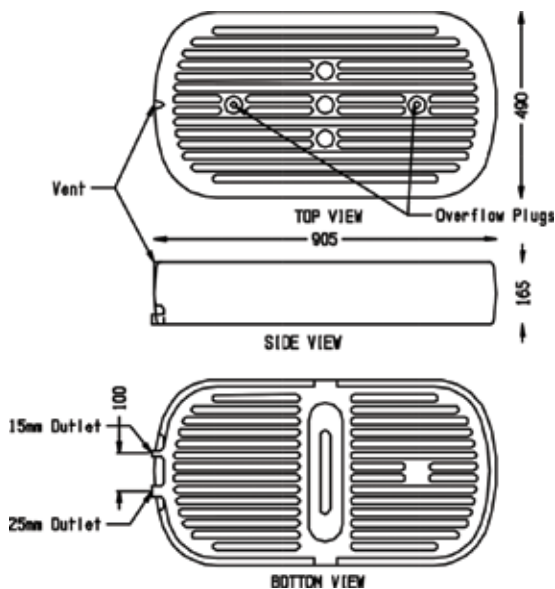

## WATER TANKS

**800-01540**  
**84L STANDARD TANK**



**Specifications**

Dimensions: 864mm x 508mm 216mm

**800-01567**  
**WATER TANK BUNGS FOR 65L AND 80L TANKS**



**800-01569**  
**WATER TANK BUNGS FOR 140L TANKS**

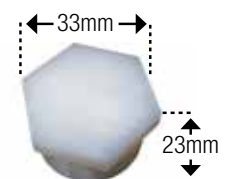

## COAST TANK

### 800-01574 90L WATER TANK WITH TAP

Has a 25mm barb.



**Specifications**

Dimensions: 1270L x 400W x 210H (mm)

### 800-01576 TOP CAP FOR JAYCO WATER TANK



### 800-01577 SPARE TAP FOR 800-01574



## HEAVY DUTY WATER TANKS

Heavy duty water tanks, robust construction with inbuilt mounting flange complete with fittings and threaded for tap facility.

### 800-01580 65L TANK

**Specifications**

Dimensions: 810 x 190 x 615mm



### 800-01582 83L TANK

**Specifications**

Dimensions: 810 x 265 x 615mm



### 800-01584 140L TANK

**Specifications**

Dimensions: 1500 x 200 x 690mm



### 800-01590 FIAMMA 70L WATER TANK

The Fiamma 70L fresh water tank is made of non-toxic material and weighs 3.7kg. Comes with all necessary fittings for installation.



**Specifications**

Dimensions: 240D x 710L x 470Wmm

### 800-01600 WATER TANK 43L MODULAR STANDARD 860 X 260 X 220MM

This new moulded modular caravan and RV water tank will change the way you use water tanks. This one tank can be configured in many ways to provide a single low cost solution.

The BR Plastics tank is blow moulded from food contact approved High Molecular Weight High Density Polyethylene. This makes the tank a super tough performer. The tank is moulded with two integral 20mm (3/4 BSP) threaded closures that can accept a wide variety of standard fixtures and fittings. Using these standard fitting the tank can be networked together to provide almost limitless water storage options for your vehicle.

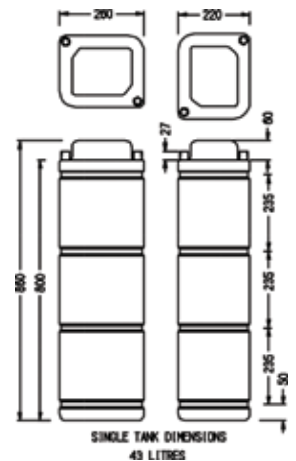

### 800-01602 WATER TANK 43L MODULAR PACK ONE 860 X 260 X 220MM

Pack One consists of:

- > 1 x 43L Tank
- > 2 x Elbows
- > 1 x 12mm Director
- > 1 x 25mm Director



### 800-01604 WATER TANK 43L MODULAR PACK TWO 860 X 260 X 220MM

Pack One consists of:

- > 1 x 43L
- > 1 x Tee
- > 1 x Cap
- > 2 x 25mm directors



**800-01606**

**WATER TANK GREY WATER 50L MODULAR 698 X 382 X 210MM**

The BR Plastics tank is blow moulded from food contact approved High Molecular Weight High Density Polyethylene. This makes the tank a super tough performer. The tank is moulded with two integral 40mm (1.5" BSP) threaded female closures that can accept a wide variety of standard fixtures and fittings. Using these standard fittings the tank can be networked together to provide many water storage options for your vehicle.



**800-01241**

**ADAPTOR KIT FOR MARINE AND OUTDOOR WATER HOSE**

Allows you to attach the hose to any garden tap. Each kit contains a tap adaptor and two snap-on hose fittings.



**800-01991**

**HOLMAN ADAPTER SET**

3 piece brass adapter set.



**800-01992**

**NETA 1 1/6" 12MM BRASS CLICK ON SPRAY ADAPTOR**

Screws into sprays or pumps and clicks into hose connections.



**800-01608**

**WATER TANK 54L CARAVAN AND RV WATER TANK 755 X 355 X 220MM**

The tank is moulded with three integral 20mm (3/4 BSP) threaded closers that can accept a wide variety of standard fixtures and fittings.



**JOHN GUEST PLUMBING FITTINGS**

**800-02000**

**JG FEMALE PLASTIC CONNECTOR FOR 12MM X 3/8" FBSP**



**800-02001**

**JG FEMALE PLASTIC CONNECTOR FOR 12MM X 3/8" FBSP**

Has a shallow (approx. 7mm deep) thread.



**800-02002**

**JG FEMALE PLASTIC CONNECTOR FOR 12MM X 1/2" FBSP**



**800-02004**

**JG 1/2 BARB FOR TUBE FITTING 15MM X 1/2"**



**800-02006**

**JG STRAIGHT 12MM X 1/2" BSPT MALE ADAPTER**



**TAP FITTINGS**

**800-01327**

**3/4" BSP SPRINKLER ADAPTOR**



**800-01328**

**3/4" - 1" TAP ADAPTOR**



## PLUMBING FITTINGS

**800-02008**  
**JG PLASTIC 12MM TEE**  
**CONNECTOR**



**800-02025**  
**JG 12MM LOCKING CLIP**  
 Bag of 100



**800-02010**  
**JG PLASTIC 12MM ELBOW**  
**CONNECTOR**



**800-02026**  
**JG 1/2" BRASS MALE ADAPTER**  
**WITH 12MM PLASTIC ELBOW**



**800-02012**  
**JG PLASTIC 12MM STRAIGHT**  
**CONNECTOR**



**800-02028**  
**JG 12MM PLASTIC SWIVEL ELBOW**  
**MALE 1/2" BSPT**



**800-02014**  
**JG PLASTIC 12MM X 1/2 BSP**  
**STRAIGHT MALE STEM ADAPTER**



**800-02030**  
**JG 12MM EQUAL DIVIDER**



**800-02016**  
**JG PLASTIC**  
**12MM X 10MM JOINER**



**800-02032**  
**JG 12MM SINGLE CHECK**  
**VALVE**



**800-02018**  
**JG PLASTIC STEM ELBOW 12MM**  
**CONNECTOR**



**800-02034**  
**JG 12MM BULKHEAD ADAPTER**



**800-02019**  
**JG BRASS STRAIGHT**  
**12MM X 1/2" NPT**



**800-02036**  
**JG 12MM SHUT-OFF VALVE PLASTIC**



**800-02023**  
**JG 12MM TUBE INSERT**  
 Bag of 100



**800-02038**  
**JG 12MM 3/8" STRAIGHT ADAPTER**  
**MALE PLASTIC**



**800-02040**  
**JG 12MM SERIES 08 RED PLUG**



**800-02104**  
**JG RED 12MM X 100M ROLL OF TUBING**  
No uv protection; sold per 100m roll.



**800-02042**  
**JG 12MM 1/2" TUBE TO HOSE BRASS**

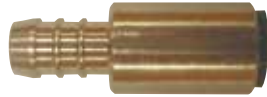

**800-02120**  
**JG BLUE 12MM X 10M ROLL OF TUBING**  
UV resistant, sold per 10m roll.



**800-02048**  
**JG TUBE TO HOSE CONNECTOR (12MM X 10MM)**



**800-02122**  
**JG BLACK 12MM X 10M ROLL OF TUBING**  
UV stabilised, sold per 10m roll.



**800-02098**  
**JG TUBE CUTTER**  
(sold separately)



**800-02124**  
**JG RED 12MM X 10M ROLL OF TUBING**  
No uv protection, sold per 10m roll.



**800-02100**  
**JG BLUE 12MM X 100M ROLL OF TUBING**  
UV resistant, sold per 100m roll.

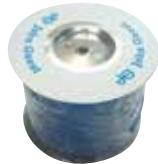

**800-02150**  
**PINK WATER SEAL TAPE 12MM X 10M ROLL**

- > Resistant to almost all types of acids, bases, solvents, chemicals etc., (with the exception of fluorine, some fluoride chemicals and melted alkali metals).
- > Non-flammable (ASTM D-635 D-470). Non-ageing. High tensile strength even at low temperatures. Break-down resistant, especially, in connection with bending and vibration
- > Suitable for Natural Gas and LPG (Propane and Butane)



**800-02101**  
**JG COLLET RELEASE TOOL SET**  
A spacing tool used to help create space for, or remove, a locking clip.



**800-02102**  
**JG BLACK 12MM X 100M ROLL OF TUBING**  
UV stabilised, sold per 100m roll.



## JOHN GUEST WATERMARK FITTINGS

The John Guest Speedfit RV Range has been specifically designed to meet Australian Standards and to be WaterMark compliant. The benefits of this range is its increased maximum working temperature and pressure. JG Speedfit tube fittings are warranted to achieve 80°C at 1000 kPa.

Push-fit plastic fitting for the connection of plastic and copper pipe. Designed, manufactured and assembled in the UK by John Guest Speedfit. Simply push the fitting fully onto the pipe and twist the plastic nut clockwise to lock in place. Should the need arise to demount the connection unlock the nut and push the collet towards the body of the fitting and pull the pipe to release. The fitting ensures an easier working environment in confined places and removes the need for hot works on site. Installation can be reduced by around 40% against traditional fixing methods.

800-02200

**JG WATERMARK EQUAL STRAIGHT CONNECTOR**  
12MM PEMO412W

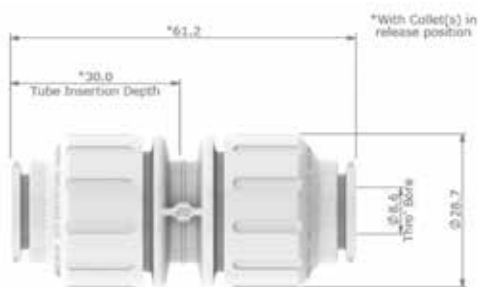

800-02202

**JG WATERMARK EQUAL ELBOW**  
12MM PEMO312W

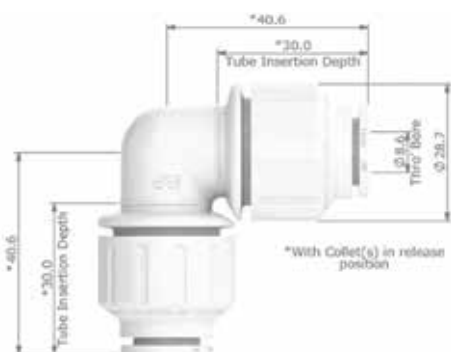

800-02204

**JG WATERMARK EQUAL TEE 12MM PEMO212W**

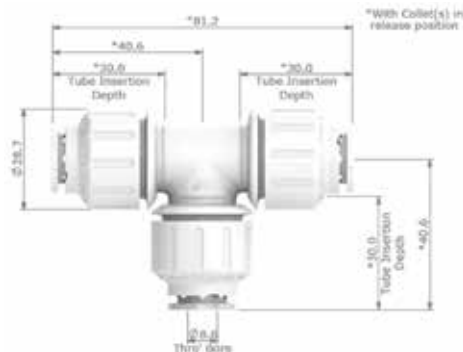

800-02206

**JG WATERMARK STEM ELBOW**  
12MM PEM221212W

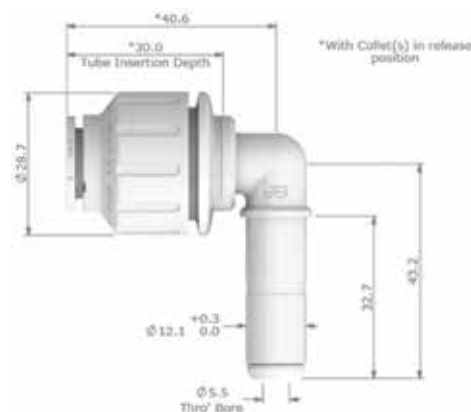

800-02208

**JG WATERMARK STEM TEE 12MM PEM531212W**

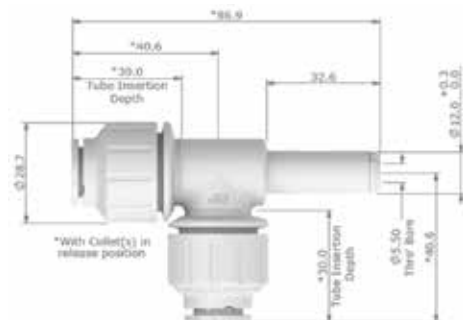



**800-02210**  
**JG WATERMARK STEM REDUCER**  
**12MM PEM061612W**

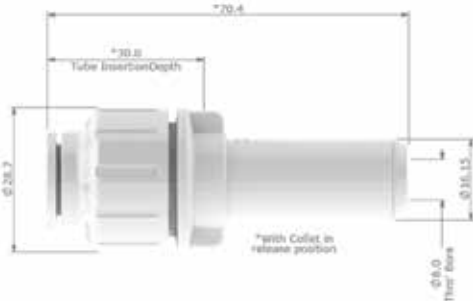

**800-02216**  
**JG WATERMARK END CAP 12MM**  
**PSE4612W**



**800-02212**  
**JG WATERMARK STRAIGHT TAP**  
**CONNECTOR 12MM PEMSTC1214 1/2**  
**BSP**

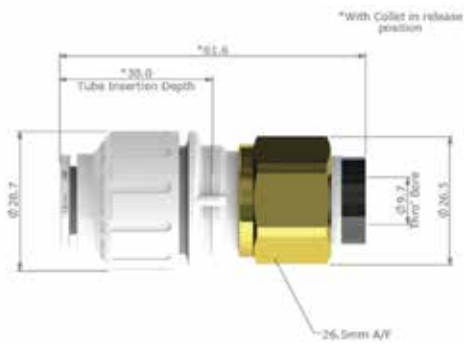

**800-02218**  
**JG WATERMARK MALE ADAPTOR**  
**12MM NC2771 1/2 BSPT**  
Ideal for use with Suburban HWS

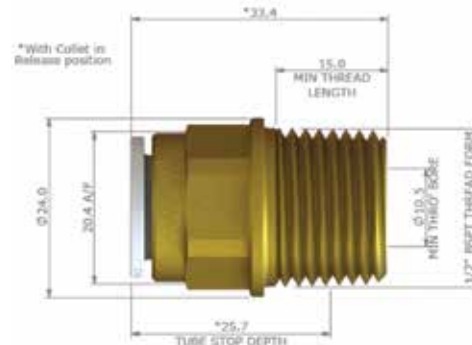

**800-02214**  
**JG WATERMARK BENT TAP**  
**CONNECTOR 12MM PEMBTC1214 1/2**  
**BSP**



**800-02220**  
**JG WATERMARK FEMALE**  
**ADAPTOR 12MM MW451213 3/8**  
**BSP**

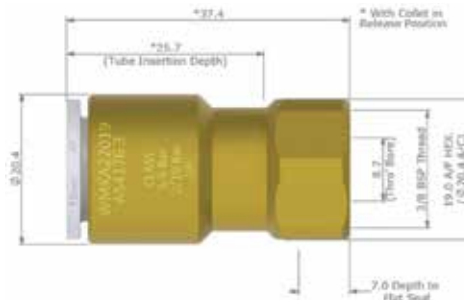

SECTION  
**7**

# PLUMBING FITTINGS

**800-02223**  
**JG WATERMARK TUBE INSERT**  
**12MM TSM12**

Bag of 50



**800-02224**  
**JG WATERMARK BPEX TUBE**  
**12MM X 50M 12BPEX-50C**



**800-02227**  
**JG WATERMARK**  
**COLLECT CLIP BLUE**  
**12MM CM1812B**

Bag of 100



**800-02229**  
**JG WATERMARK**  
**COLLECT CLIP RED**  
**12MM CM1812R**

Bag of 100



**PLASTIC PLUMBING FITTINGS**

**800-02300**  
**PLASTIC BARBED ELBOW 13MM**



**800-02302**  
**PLASTIC BARBED ELBOW 19MM**



**800-02304**  
**PLASTIC BARBED**  
**ELBOW 25MM**



**800-02306**  
**PLASTIC BARBED**  
**JOINER 13MM**



**800-02308**  
**PLASTIC BARBED JOINER**  
**19MM**



**800-02310**  
**PLASTIC BARBED JOINER**  
**25MM**



**800-02312**  
**PLASTIC BARBED**  
**TEE 13MM**



**800-02314**  
**PLASTIC BARBED**  
**TEE 19MM**



**800-02316**  
**PLASTIC BARBED**  
**TEE 25MM**



**800-02318**  
**PLASTIC BARBED**  
**END PLUG 13MM**



**800-02320**  
**PLASTIC BARBED**  
**END PLUG 19MM**



# PLUMBING FITTINGS

## SECTION 7

800-02322  
PLASTIC BARBED END  
PLUG 25MM



800-02324  
PLASTIC BARBED REDUCING  
JOINER 19MM X 13MM



800-02326  
PLASTIC BARBED REDUCING  
JOINER 25MM X 13MM



800-02328  
PLASTIC BARBED REDUCING  
JOINER 25MM X 19MM



800-02330  
19MM BARBED X 13MM  
BRANCH TEE



800-02332  
25MM BARBED X 13MM  
BRANCH TEE



800-02334  
25MM BARBED X 19MM  
BRANCH TEE



800-02336  
13MM BARBED X 19MM BRANCH  
TEE



800-02338  
19MM BARBED X 25MM BRANCH TEE



800-02340  
13MM BARBED X 1/2" BSP FEMALE  
THREADED ELBOW



800-02342  
19MM BARBED X 1/2" BSP  
FEMALE THREADED ELBOW



800-02344  
25MM BARBED X 1/2" BSP  
FEMALE THREADED ELBOW



800-02346  
13MM BARBED X 1/2" BSP  
FEMALE THREADED TEE



800-02348  
19MM BARBED X 1/2" BSP  
FEMALE THREADED TEE



800-02350  
25MM BARBED X 1/2" BSP  
FEMALE THREADED TEE



800-02352  
13MM BARBED X 1/2" BSP  
MALE THREADED TEE



800-02354  
19MM BARBED X 1/2" BSP  
MALE THREADED TEE



## PLUMBING FITTINGS

800-02356

19MM BARBED X 3/4" BSP  
MALE THREADED TEE

800-02372

19MM BARBED X 1/2" BSP  
MALE THREADED CORNER ELBOW

800-02358

25MM BARBED X 1/2" BSP  
MALE THREADED TEE

800-02374

19MM BARBED X 1/2" BSP  
FEMALE THREADED CORNER ELBOW

800-02360

25MM BARBED X 3/4" BSP  
MALE THREADED TEE

800-02376

25MM BARBED X 1/2" BSP  
MALE THREADED CORNER ELBOW

800-02362

13MM BARBED X 1/2" BSP  
MALE THREADED ELBOW

800-02378

19MM BARBED X 1/2" BSP  
MALE THREADED SIDE OUTLET  
TEE

800-02364

19MM BARBED X 1/2" BSP  
MALE THREADED ELBOW

800-02380

19MM BARBED X 1/2" BSP  
FEMALE THREADED SIDE OUTLET  
TEE

800-02366

19MM BARBED X 3/4" BSP  
MALE THREADED ELBOW

800-02382

3/4" BSP NUT X 13MM TAIL



800-02368

25MM BARBED X 1/2" BSP  
MALE THREADED ELBOW

800-02384

3/4" BSP NUT X 19MM TAIL



800-02370

25MM BARBED X 3/4" BSP  
MALE THREADED ELBOW

800-02385

NUT AND TAIL HANSEN (40MM)  
- 1.5" BSPT X 40MM TAIL

# PLUMBING FITTINGS

**800-02386**  
**1" BSP NUT X 13MM TAIL**



**800-02388**  
**1" BSP NUT X 19MM TAIL**



**800-02390**  
**1" BSP NUT X 25MM TAIL**



**800-02392**  
**PLASTIC BARBED IN-LINE VALVE 25MM**



**800-91000N**  
**PIPELINE FEMALE CAMLOCK WITH HOSE TAIL (25MM)**  
Made from polypropylene with a 25mm thread.



**800-91002N**  
**PIPELINE FEMALE CAMLOCK WITH HOSE TAIL (32MM)**  
Made from polypropylene with a 32mm thread.



**800-91004N**  
**PIPELINE MALE CAMLOCK (25MM)**  
Made from polypropylene with a 25mm BSP thread.



**800-91006N**  
**PIPELINE MALE CAMLOCK (32MM)**  
Made from polypropylene with a 32mm BSP thread.



**800-91008N**  
**PIPELINE DUST CAP (25MM)**  
Made from polypropylene with a 25mm BSP thread.



**800-91010N**  
**PIPELINE DUST CAP (32MM)**  
Made from polypropylene with a 32mm BSP thread.



**800-91012N**  
**PIPELINE BALL VALVE (25MM)**  
Made from polypropylene, this spin weld ball valve has a 25mm thread.



**800-91014N**  
**PIPELINE BALL VALVE (32MM)**  
Made from polypropylene, this spin weld ball valve has a 32mm thread.



**800-91016N**  
**PIPELINE GREY HOSE - 25MM**  
Sold per metre.



**800-91018N**  
**PIPELINE GREY HOSE - 32MM**  
Sold per metre.



**800-91020N**  
**PIPELINE WASTE KIT WITH HOSE (25MM)**  
Kit consists of: x1 800-91012N, x1 800-91000N, x1 800-91004N, x1 800-91008N and x3 800-91016N



**800-91022N**  
**PIPELINE WASTE KIT WITH HOSE (32MM)**  
Kit consists of: x1 800-91014N, x1 800-91002N, x1 800-91006N, x1 800-91010N and x3 800-91018N



# TANK MONITOR

## FUEL SAFE ALL PLASTIC CANS

These fuel safe cans are made from high strength polyethylene for the safe transportation of fuel and other flammable liquids. Features an anti-glug pourer.

**800-02400**  
**FUEL SAFE PLASTIC 5L FUEL CAN**



**800-02410**  
**FUEL SAFE PLASTIC 10L FUEL CAN**



**800-02420**  
**FUEL SAFE PLASTIC 20L FUEL CAN**



## ACCUMULATOR TANKS

**800-03000**  
**SHURFLO ACCUMULATOR TANK**



**800-03010**  
**FIAMMA A20 ACCUMULATOR TANK**



**800-91096N**  
**ROLL TANK HOSE KIT (25MM)**

Kit consists of: x2 800-91000N and x1 800-91016N



**800-91098N**  
**ROLL TANK HARDWARE KIT (25MM)**

Kit consists of: x1 800-91024N, x1 800-91026N, x1 800-91028N, x1 800-91004N, x1 800-91008N and x1 800-91030N



## JRV TANK MONITOR

**800-03100**  
**Features**

Easy to install, has gauges for 2 fresh water tanks, 1 grey water tank, Battery level indicator and has pump switch



**Specifications**

Dimensions: 119W x 98H x 13D (mm)

**800-03102**  
**Features**

Easy to install, has a gauge for 1 fresh water tank, Battery level indicator and has pump switch



**Specifications**

Dimensions: 119W x 98H x 13D (mm)

**800-03104**  
**Features**

Easy to install, has gauges for 2 fresh water tanks, Battery level indicator and has pump switch



**Specifications**

Dimensions: 119W x 98H x 13D (mm)

**800-03196**  
**WATER SENSOR TANK HARNESS**

**800-03198**  
**JRV TANK WELL NUT ONLY FOR MONITOR**

# WATER TANK CLEANERS

800-04030

## TASTE PURE (WATER FRESHENER)

Eliminate algae and slime buildup from drinking water tanks. Just 28 grams helps remove bad smells and taste from 75L of water (473ml Bottle)



800-04040

## GREY WATER DEODORISER

Deodorize black and grey water tanks with these compact tablets. One tablet treats up to 150L. (Pack of 6)



800-04042

## CAMCO TST GREY WATER ODOR CONTROL - 32 OZ 946 ML

Remove grease buildup in your grey water tank, sink and shower drain lines with this concentrated treatment. Only 100ml per 140L eliminates foul odors, leaving a fresh lemon scent.



800-04100

## NATURAL WATER CHLORINE DIOXIDE TABLETS 8 X 4 GRAMS

Water tanks in caravans and campers need to be treated regularly to ensure there is no harmful build-up of micro-organisms and biofilm. The fact that caravans are often not used for prolonged periods of time makes it even more crucial to keep the water safe for cooking and consumption.



Organic material in water tanks can be harmful to your health and negatively affects the taste and odour of water. The build-up of biofilm in pipes can also cause problems in the flow-rate and longevity of your system. CleanOxide®, which is Chlorine Dioxide, is the most effective product on the market to clean water tanks and ensure the water is safe for consumption.

- > Effective over a broad pH range (4 to 10)
- > Controls bacteria, fungi, viruses, biofilm and algae.
- > Neutralises unpleasant taste and odours from tank water.
- > Safer than Chlorine. CleanOxide® does not react with ammonia and does not produce toxic compounds in contact with organic materials present in water.
- > Effective at lower dose rates than chlorine or bromine.
- > Non-corrosive at the recommended dose rates
- > Bio-degrades in sunlight, so no harmful effect on the environment when flushing your tank.
- > Micro-organisms do not develop resistance to CleanOxide®.
- > Approved in Australia for the treatment of drinking water since 2005.
- > Each 4 gram tablet treats 100 to 400 litres of water.

800-04110

## NATURAL WATER CLEANOXIDE GEL

Unlike most conventional Odour treatments that merely mask bad smells our CleanOxide® Gel actually has the ability to kill the source of the problem. The Chlorine Dioxide that is released from the Gel works by destroying part of the odour molecule, stripping it of its odour potential. It is the oxygen ions that are doing the work, killing the airborne bacteria, mould or viruses and safely eliminating odour.



- > Slow regulated release of chlorine dioxide vapour at undetectable and safe levels.
- > Simple mixing instructions
- > 1 packet treats up to 25m<sup>2</sup> (floor area).

800-04120

## TANK CLEANSE PRO

Tank Cleanse Pro is the ultimate water tank cleaner, destainer and sanitiser.

Ideal for Caravan, Motorhome and Boat water tanks, Tank Cleanse Pro's concentrated formula ensures that freshwater systems are free from water tainting.



Over time, stagnant water in your RV's water tank allows for the build-up of algae, mould and other harmful bacteria. Cleanse your freshwater tank for better tasting drinking and cooking water with Tank Cleanse Pro.

Tank Cleanse Pro's concentrated formula treats up to 200L of water.

## SINKS

800-04900

## ARGENT SINK MK3 (LEFT HAND)

This Argent sink has a left handed drain and comes with a smoked black glass lid.



### Specifications

**Overall Dimensions:** 152H x 630W x 470D (mm)  
**Worktop Cut-Out Dimensions:** 605W x 415D (mm)  
**Inside Bowl Dimensions:** 100H x 290W x 368D (mm)  
**Sink Capacity:** 9.6L  
**Net Weight:** 5.5kg

**800-04910**

**KITCHEN CENTRE MK3**

A complete kitchen sink set, including plastic wash bowl, chopping board, draining board and draining rack. All accessories fit inside the stainless steel sink when not being used, which makes the Kitchen Centre a beautiful space saver. Comes with a smoked black glass lid.



**Specifications**

Overall Dimensions: 153H x 360W x 470D (mm)  
Worktop Cut-Out Dimensions: 335W x 430D (mm)  
Inside Bowl Dimensions: 99H x 290W x 368D (mm)  
Sink Capacity: 11L  
Net Weight: 3.6kg

**800-04971**

**DOMETIC/SMEV FLUSH MOUNT BASIN C/W GLASS LID**

A flush mount, stainless steel basin with a glass lid. It comes with a plug and waste kit. Now a kit.



**Specifications**

Dimensions: 420 x 440 x 145 (mm)



**800-04972**

**DOMETIC/SMEV MIXER TAP T/S FLUSH MOUNT BASIN C/W GLASS LID**

A flush mount, stainless steel basin with a glass lid. It comes with a plug and waste kit. Now a kit.



**Specifications**

Dimensions: 145H x 420W x 440D (mm)



**800-04982**

**SMEV SINK WITH DRAINER**

A flush mount, stainless steel basin that comes with a plug and waste kit.



**Specifications**

Dimensions: 125H x 590W x 370D (mm)



**800-04984**

**SMEV SINK WITH DRAINER**

A flush mount, stainless steel basin that comes with a plug and waste kit.



**Specifications**

Dimensions: 145H x 650W x 380D (mm)



**800-04986**

**SMEV SINK (SQUARE)**

A top fixing stainless steel sink with an inox finish. Comes with a plug and waste kit.



**Specifications**

Dimensions: 370W x 370D x 125H (mm)

**800-04988**

**SMEV SINK (RECTANGULAR)**

A flush mount stainless steel sink with an inox finish. Comes with a plug and waste kit.



**Specifications**

Dimensions: 280W x 380D x 145H (mm)

**THETFORD SINKS**

**800-90004N**

**THETFORD SINK - LEFT HAND DRAIN**

A top mount stainless steel sink with left hand drain section. It also features a smoked glass lid which allows you to maximize your work area whilst it is closed.



**Specifications**

Dimensions: 630W x 475D x 160D (mm)

**800-90006N**

**THETFORD SINK - RIGHT HAND DRAIN**

A top mount stainless steel sink with right hand drain section. It also features a smoked glass lid which allows you to maximize your work area whilst it is closed.



**Specifications**

Dimensions: 630W x 475D x 160H (mm)

**800-90008N**

**THETFORD BASIC LINE 340 SINK**

A stainless steel sink with a black glass lid and water tap hole. It is easy to clean and comes with a siphon and bung (a plug), it weighs just 2.9kg.

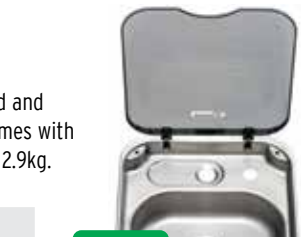

**Specifications**

External Dimensions: 140H x 400W x 445D (mm)  
Cut Out Dimensions: 387W x 429D (mm)  
Capacity: 7.5L



**800-04957**

**KITCHEN SINK 2011**

Stylish and modern stainless steel sink and drainer with rounded corners and round bowl, complete with fitting brackets.



**Specifications**

Length: 720mm

Wide: 440mm

Bowl Diameter: 365mm

Bowl Depth: 160mm

**800-90500N**

**THETFORD BEZEL FOR SINKS (BLACK)**

A rubber bezel suited to 800-90000N and 800-90002N and is sold per metre. Suitable for use as a sealant around the edges of a sink (instead of using a silicone sealant).



**800-04992**

**SMEV SINK PLUG**

A replacement plug to suit Smev sinks and has a 38mm diameter.



**800-04994**

**SMEV PLUG AND WASTE KIT (STRAIGHT)**

Plug and waste kit to suit SMEV sink (25mm straight)



**800-04996**

**PLUG AND WASTE KIT TO SUIT SMEV SINK (25MM 90°)**



**800-90502N**

**SPINFLO 19MM WASTE STRAIGHT**

**800-90504N**

**SPINFLO 19MM WASTE ANGLED**

**800-90506N**

**SPINFLO 19MM SINK WASTE PLUG ONLY**



**800-04997**

**SMEV SINK RUBBER SEAL**

Black rubber seal for SMEV sinks, sold in 3m lengths.



**800-05112**

**RUBBER SINK PLUG**

Red rubber sink plug 25mm with pull shackle.



## WASTE OUTLETS

**800-05150**

**WASTE OUTLET 25MM STRAIGHT WHITE**



**800-05152**

**WASTE OUTLET 25MM STRAIGHT GREY**



**800-05160**

**WASTE OUTLET 25MM 90° WHITE**



**800-05162**

**PLASTIC SILVER/GREY 25MM WASTE OUTLET, 90°**



## CERAMIC BATHROOM BASINS

Modern round designed ceramic sink basins with a smooth glazed finish. Featuring a Fireclay construction for increased strength and durability, perfect for mobile applications.

- > Heat Resistant up to 1515°C
- > Impact Resistant
- > Dirt & Stain Resistant
- > Easy Cleaning
- > Chemical Resistant
- > Hypoallergenic

**800-06350**  
**CERAMIC BATHROOM ROUND BASIN**  
**(320X320X145MM)**  
**- GLOSS WHITE**



**800-06351**  
**CERAMIC BATHROOM OVAL BASIN**  
**(405X330X145MM)**  
**- GLOSS WHITE**



**800-06360**  
**CERAMIC BATHROOM OVAL BASIN**  
**(405X330X145MM)**  
**- MATT BLACK**



**800-06361**  
**CERAMIC BATHROOM OVAL BASIN**  
**(405X330X145MM)**  
**- MATT BLACK**



**800-06370**  
**CHROME PUSH BUTTON WASTE T/S**  
**WHITE CERAMIC BASINS**



**800-06371**  
**MATT BLACK PUSH BUTTON WASTE**  
**T/S BLACK BASINS**



## EXTERNAL SHOWER BOX WATERMARKED

A lockable external shower unit with hot and cold mixer taps, perfect for cleaning up before entering your RV.

- > Can be mounted either vertically or horizontally with soap holder feature moulded into the body.
- > Hand Shower Holder can be fitted inside of the door to suit mounting orientation
- > Feature quarter turn ceramic disk valves so the fittings turn in the opposite direction remaining mirrored in the open position.
- > Watermarked Approved tap and fittings
- > Supplied with soft backing gasket

## Specifications

Dimensions: 325W x 200H x 99D (mm)

**800-05900**  
**EXTERNAL SHOWER BOX**  
**WATERMARKED**  
**- BLACK**



**800-05902**  
**EXTERNAL SHOWER BOX**  
**WATERMARKED - WHITE**



**800-06000**  
**AUX EXTERNAL SHOWER**  
**UNIT - BLACK**

UV and impact resistant, it features an enclosed casing which prevents potential water leakage into the wall of your RV. Thanks to the large flange, it can easily be retrofitted into other external shower cutouts. It comes with a key to lock the lid when not in use and an adjustable water flow toggle lever.



## Specifications

Water Flow: 9.5L/min max.

Cut-out Dimensions: 150H x 279W (mm)

Total Depth: 119 (mm)

## BATHROOM FITTINGS

**800-06002****AUX EXTERNAL SHOWER UNIT - WHITE**

UV and impact resistant, it features an enclosed casing which prevents potential water leakage into the wall of your RV. Thanks to the large flange, it can easily be retrofitted into other external shower cut-outs. It comes with a key to lock the lid when not in use and an adjustable water flow toggle lever.

**Specifications**

Water Flow: 9.5L/min max.

Cut-out Dimensions: 150H x 279W (mm)

Total Depth: 119(mm)

**SHOWER HOSES****800-06028****HAND HELD SHOWER KIT**

Includes hose, rose and bracket.

**800-06030****EUTOPIA HAND HELD SHOWER KIT**

Includes the hose, rose and bracket

**800-06040****CHROME SHOWER HEAD KIT**

Save water with this showerhead kit, thanks to a handy on/off switch that allows you to pause the water flow whilst you shampoo. This showerhead features four spray patterns from a gentle spray to hard rain. Each kit includes: a chrome showerhead, flexible shower hose (1.5m), washers, a wall mount and hardware.

**HOT AND COLD SHOWER MIXERS****800-06102****EUTOPIA WHITE SHOWER MIXER 1/2" THREAD****800-06103****EUTOPIA CHROME SHOWER MIXER 1/2" THREAD****HAND PUMPS****800-06400****TROJAN HAND PUMP - WHITE**

Has an efficient dual pumping action and its interior seals are made of polyurethane. Requires a 32mm hole.

**800-06410****BREHA HAND PUMP (PLASTIC SHAFT) WHITE****800-06414****BREHA HAND PUMP (PLASTIC SHAFT) BLACK**

SECTION  
**7**

# BATHROOM FITTINGS

**800-06450**

**COAST CHROME HAND PUMP**

Has a grey plastic shaft with chrome accents and spout.

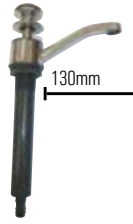

**COAST WATERMARK CHROME  
BATHROOM FIXTURES**

**800-06700**

**CHROME FLICK MIXER  
WITH 160MM SPOUT**



**BATHROOM MODULE**

**800-06650**

**VT90 MODULE LOWER BASIN  
SECTION ONLY**

**Specifications**

Dimensions: 820 x 670 x 160mm



**800-06710**

**CHROME FLICK MIXER  
WITH 190MM SPOUT**



**800-06655**

**VT90 C400 TOILET  
SPACER**



**800-06720**

**CHROME SHOWER FLICK MIXER**



**800-06660**

**VT90 MODULE UPPER VANITY  
SECTION ONLY WITH MIRROR  
DOORS**

**Specifications**

Dimensions: 560H x 670W x 130D (mm)



**800-06730**

**CHROME SHOWER RAIL**

with Hose, Rose and Soap Dish



**800-06670**

**ACRYLIC SOAP HOLDER  
- WHITE**

**Specifications**

Dimensions: 328H x 220W x 90D



**800-06750**

**HIGH RISE SINK MIXER  
(35MM)**

Has a 4 star water rating, consuming 7.5L per minute. Comes with a 5yr manufacturer's warranty on the cartridge only.



**800-06760**

**COAST SHOWER MIXER (35MM)**

A wall mountable shower mixer, comes with a 5yr manufacturer's warranty (on the cartridge only).



**800-06776**

**COAST WATERMARK HOT AND COLD MIXER FAUCET WITH FOLD DOWN SPOUT**

Hot and cold mixer faucet chrome with folding/swivel spout.



**Specifications**

Height: 200mm (when fitted)

Height when folded: 70mm (when fitted)

Thread Size: 3/8 FBSP WaterMarked Certified

**800-06770**

**COAST HIGH RISE SINK MIXER WITH 13CM SPOUT**



**800-06782**

**LOW PROFILE FOLD DOWN SINK MIXER TAP WATERMARKED**

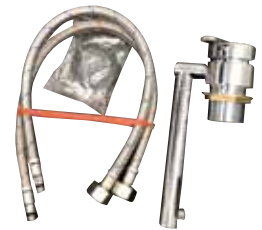

**800-06772**

**COAST WATERMARK RIGHT HAND TAP, FOLD DOWN FAUCET**

Right hand tap, fold down chrome faucet, conveniently folds down into the sink when not being used. Can be used for hot or cold water



**Specifications**

Height: 180mm (when fitted)

Height when folded: 70mm (when fitted)

Thread Size: 3/8 FBSP WaterMarked Certified

**800-06900**

**TV15 1/2 MALE TEMPERING VALVE**



**Specifications**

Cold Water Supply Temperature: 5°C - 30°C

Hot Water Supply Temperature: 60°C - 90°C

Set Temperature: 50°C standard (must be commissioned onsite by installer)

Accuracy of Outlet Temperature: +/- 3°C (as per AS4032.2)

Maximum Working Pressure (Static): 1400Kpa

Maximum Working Pressure (Dynamic): 500Kpa

Minimum Flow Rate: 3.6L/min under outlet pressure 10Kpa

**800-06774**

**COAST WATERMARK LEFT HAND TAP, FOLD DOWN FAUCET**

Left hand tap, fold down chrome faucet, conveniently folds down into the sink when not being used. Can be used for hot or cold water (red and blue buttons included).



**Specifications**

Height: 180mm (when fitted)

Height when folded: 70mm (when fitted)

Thread Size: 3/8 FBSP WaterMarked Certified

**800-06904**

**JG 12MM NEW TEMPERING VALVE**



## COAST BATHROOM TOWEL SHELF

A compact towel rack with a large built in shelf finished in polar white that attaches to a wall via its built-in concealed screw bases, it is made from sturdy ABS Plastic & Aluminium while weighing only 1.17kg



**Specifications**

Dimensions: 600 x 220 x 113mm (LxDxH)

**800-09000**

**COAST BATHROOM TOWEL SHELF WHITE**

**800-09002**

**COAST BATHROOM TOWEL SHELF BLACK**

## COAST BATHROOM TOILET BRUSH & HOLDER

Bristled Toilet brush & angled wall bracket holder made from ABS plastic & finished in polar white, holder cup is removable from wall bracket for easy cleaning. Product weight is 0.37 kg



**Specifications**

Dimensions: 112 x 133 x 370mm (LxDxH)

**800-09004**

**COAST BATHROOM TOILET BRUSH & HOLDER WHITE**

**800-09006**

**COAST BATHROOM TOILET BRUSH & HOLDER BLACK**

## COAST BATHROOM TOILET ROLL HOLDER

Simple hook style toilet roll holder made from ABS plastic & aluminium that is finished in polar white, it attaches to the wall via its built-in concealed screw in base. Product weight is 220 grams



**Specifications**

Dimensions: 148 x 82 x 110mm (LxDxH)

**800-09008**

**COAST BATHROOM TOILET ROLL HOLDER WHITE**

**800-09010**

**COAST BATHROOM TOILET ROLL HOLDER BLACK**

## COAST BATHROOM SML COMMODITY BASKET

Small wall-mount basket made from ABS plastic & finished in polar white. Product weight is 250 grams



**Specifications**

Dimensions: 250 x 112 x 40mm (LxDxH)

**800-09012**

**COAST BATHROOM SML COMMODITY BASKET WHITE**

**800-09014**

**COAST BATHROOM SML COMMODITY BASKET BLACK**

## COAST BATHROOM TOWEL BAR

Simple wall mount towel bar made from ABS plastic & aluminium that is finished in polar white, it attaches to the wall via its built-in concealed screw in base. Product weight is 460 grams



**Specifications**

Dimensions: 600 x 200 x 113mm (LxDxH)

**800-09016**

**COAST BATHROOM TOWEL BAR WHITE**

**800-09018**

**COAST BATHROOM TOWEL BAR BLACK**

## COAST BATHROOM LGE COMMODITY BASKET

Wall mount basket that is two pieces to allow for a drainage tray, it made from ABS plastic & is finished in polar white. Product weight is 560 grams



**Specifications**

Dimensions: 350 x 127 x 56mm (LxDxH)

**800-09020**

**COAST BATHROOM LGE COMMODITY BASKET WHITE**

**800-09022**

**COAST BATHROOM LGE COMMODITY BASKET BLACK**

# FIAMMA BIPOTS

## FIAMMA BI-POTS

These Italian Bi-Pots are a simple, and strong, self-contained fresh water flushing portable toilet. They can be dismantled (valve inclusive) to facilitate a thorough cleaning and emptying is easy and hygienic thanks to the large discharge openings. Stainless steel side hooks securely lock the top tank to the waste tank ensuring no movement whilst in use. The waste tank is made of a one-piece moulding which means no nasty leaks and the release valve is watertight too with a handy anti-odour seal. Semi-transparent lids (on the waste outlet and the top tank inlet) help to keep track of each tank's internal level so you know when to empty or top up. Both tanks are scratch resistant.

### 850-00500 FIAMMA BI-POT 34

#### Specifications

Top tank capacity: 15L  
Waste tank capacity: 13L  
Weight: 4.3kg

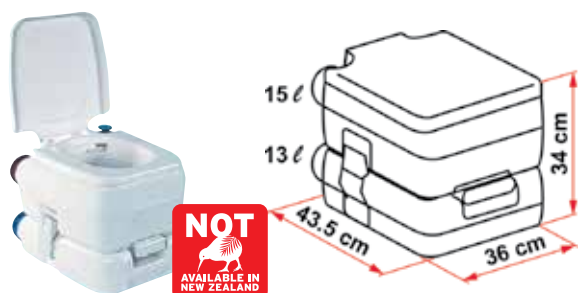

### 850-00502 FIAMMA BI-POT 39

#### Specifications

Top tank capacity: 15L  
Waste tank capacity: 20L  
Weight: 4.4kg

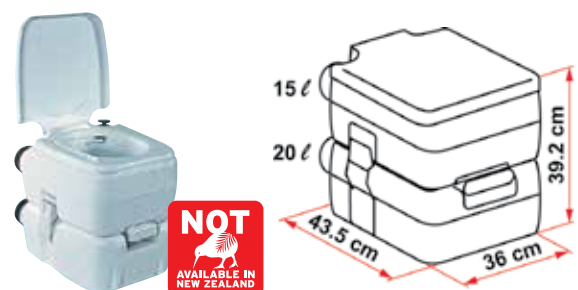

### 850-00510 FIAMMA BI-POT 30

#### Specifications

Top tank capacity: 10L  
Waste tank capacity: 11L  
Weight: 3.9kg

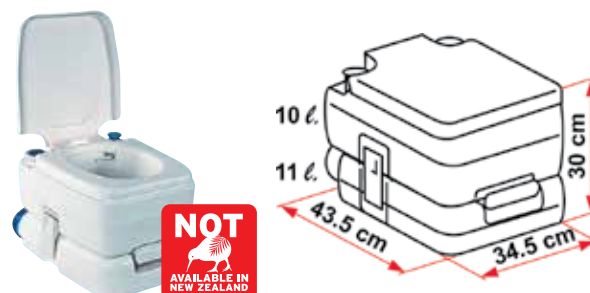

### 850-00592 FIAMMA SLIDE VALVE KIT FOR 1513,1520 AND BIPOT 30



### 850-00602 FIAMMA BI-POT TOP RUBBER SEAL FOR SLIDE VALVE



### 850-00612 FIAMMA BI-POT WHITE LOCKING SIDE HINGE



### 850-00618 FIAMMA BI-POT LARGE CAP FOR TOP OR BOTTOM TANK



### 850-00619 FIAMMA BI-POT LARGE CAP SEAL



# THETFORD POTRA POTTIS

**850-00650**  
**FIAMMA BI-POT 30**  
**TOP TANK CAP**



## THETFORD PORTA POTTIS

Made from a light but tough plastic, these Porta Pottis are hermetically sealed (meaning that the seals are completely airtight, ensuring no unpleasant smells can escape!) Cleaning is also made easy thanks to detachable toilet seats. Available in five sizes, the range features lid clips (these keep the lid down when not in use). They also feature a vent button for 'no splash' emptying and a holding tank indicator to tell when it's time for emptying. Comes with a limited 3 year warranty.

**850-00800**  
**145 (WHITE)**

### Specifications

Dimensions: 330H x 383W x 427D (mm)  
Seat Height: 324 (mm)  
Flushing System: Bellow  
Holding Tank Capacity: 12L  
Flush Tank Capacity: 15L  
Net Weight: 3.6kg



**850-00810**  
**165 (WHITE)**

### Specifications

Dimensions: 414H x 383W x 427D (mm)  
Seat Height: 408 (mm)  
Flushing System: Bellow  
Holding Tank Capacity: 21L  
Flush Tank Capacity: 15L  
Net Weight: 3.9kg



**850-00820**  
**335 (WHITE)**

(Comes standard with a hold down kit)

### Specifications

Dimensions: 313H x 342W x 382D (mm)  
Seat Height: 308 (mm)  
Flushing System: Piston  
Holding Tank Capacity: 10L  
Flush Tank Capacity: 10L  
Net Weight: 3.3kg



**850-00830**  
**345 (WHITE)**

### Specifications

Dimensions: 330H x 383W x 427D (mm)  
Seat Height: 324 (mm)  
Flushing System: Piston  
Holding Tank Capacity: 12L  
Flush Tank Capacity: 15L  
Net Weight: 3.8kg



**850-00840**  
**QUBE 365 (WHITE)**

### Specifications

Dimensions: 414H x 383W x 427D (mm)  
Seat Height: 408 (mm)  
Flushing System: Piston  
Holding Tank Capacity: 21L  
Flush Tank Capacity: 15L  
Net Weight: 4.0kg



**850-00850**  
**THETFORD PORTA POTTI 565P (WHITE)**

The 565 is the cream of Thetford's Porta Potti crop! Featuring stylish good looks, it also has a functional 443mm seat height. It also features a built-in toilet roll holder, tank level indicators and an integrated seat cover lock.

### Specifications

Dimensions: 458H x 388W x 450D (mm)  
Seat Height: 443mm  
Flushing System: Piston  
Holding Tank Capacity: 21L  
Flush Tank Capacity: 15L  
Net Weight: 5.5kg



**850-00860**  
**THETFORD PORTA POTTI E565E (WHITE)**

The 565 is the cream of Thetford's porta potti crop! Featuring stylish good looks it also has a functional 443mm seat height. It has an electric flush system (operates on x6 1.5V AA batteries which lasts 500-700 flushes). It also features a built-in toilet roll holder, tank level indicators and an integrated seat cover lock.

### Specifications

Dimensions: 458H x 388W x 450D (mm)  
Seat Height: 443 (mm)  
Flushing System: Electric (battery)  
Holding Tank Capacity: 21L  
Flush Tank Capacity: 15L  
Net Weight: 5.5kg





## THETFORD TOILET ADDITIVES

From the makers of *Porta Potti*

**THETFORD**

**WORLD'S NO. 1 IN TOILET ADDITIVES**

Your Thetford Toilet is the best mobile toilet in the market. To ensure you maintain this top quality product and enjoy a carefree and comfortable holiday, you should always use Thetford products for your Thetford toilet, because only the best will do.

### THETFORD AQUA CONCENTRATED 780ML

The Thetford Concentrated family features a smaller bottle that makes a bigger impact. Less = more! 0.78L Aqua Kem® CONCENTRATED = 2L Aqua Kem. The powerful new ultra-concentrated range offers outstanding odour control, an equal number of dosages compared to a 2L bottle, less weight and easy to handle bottle.

#### 850-01025 THETFORD AQUA KEM BLUE CONCENTRATED 780ML

Concentrated toilet fluid for the waste-holding tank. A powerful, highly effective, 2 1/2 times concentrated toilet fluid for the waste-holding tank of your Cassette and portable toilet.



#### 850-01029 THETFORD AQUA KEM LAVENDER CONCENTRATED 780ML

The powerful new ultra-concentrated range offers outstanding odour control, an equal number of dosages compared to a 2L bottle, less weight and an easy to handle bottle.



# THETFORD TOILET ADDITIVES

**850-01035**

## THETFORD AQUA KEM GREEN CONCENTRATED 780ML

Environmentally conscious, highly effective, 2 times concentrated toilet fluid for the waste-holding tank of your Cassette and portable toilet.



**850-01039**

## THETFORD AQUA KEM BLUE EUCALYPTUS CONCENTRATED 780ML

Concentrated toilet fluid for the waste-holding tank.

A powerful, highly effective, 2+ times concentrated toilet fluid with a fresh eucalyptus fragrance for the waste-holding tank of your Cassette and portable toilet.



**850-01042**

## THETFORD AQUA RINSE PINK CONCENTRATED 780ML

A highly effective, 2 times concentrated, fresh smelling fluid for the flush water tank of your Cassette and portable toilet.



## THETFORD AQUA KEM BLUE

Aqua Kem Blue is a powerful and easy to use additive for waste holding tanks. It has a pine scent and can be used in Cassette Toilets as well as Porta Pottis. Its formula is derived not only to suppress unpleasant smells and reduce gas build-up, but also to break down solids and toilet tissue. To use, simply pour 150ml into a 20Lt waste tank. Add 2-3Lt of water to ensure optimum performance. Thetford recommends refreshing every 4-5 days.



**850-01028**

## AQUA KEM BLUE (2L)

## THETFORD AQUA KEM GREEN

Aqua Kem Green is the environmentally conscious version of the Aqua Kem Blue. It has a lingering lemon scent that lasts for up to 4 days. It reduces gas build-up, eliminates nasty smells and also breaks down solids and toilet tissue. To use, simply pour 150ml into a 20Lt waste tank. Add 2-3Lt of water to ensure optimum performance. Aqua Kem Green is safe to empty into septic tanks (Test ISO 11734).



**850-01038**

## AQUA KEM GREEN (2L)

## THETFORD AQUA RINSE PLUS

Aqua Rinse Plus is a highly effective, fresh smelling fluid for the flush-water tank. It enables a more effective flush and keeps the flush water clean. It's suitable for disposal into septic tanks (Test ISO 11734) and also lubricates the seals. Suitable for use in Cassette Toilets and Porta Pottis. Available in two sizes.



**850-01043**

## AQUA RINSE PLUS (2L)

# THETFORD TOILET ADDITIVES

**850-01060**

## THETFORD CASSETTE TANK CLEANER

A powerful fluid for periodical cleaning and maintenance of the waste-holding tank. Cassette Tank Cleaner thoroughly cleans the waste-holding tank and prolongs its life span. No scrubbing required! Simply pour 300ml into your tank and fill with approx. 5Lt of water. Leave it on each side for about 8hrs and rinse after. Available in a 1Lt bottle.



**850-01066**

## THETFORD TOILET BOWL CLEANER

A cleaner for the inner side of the toilet bowl. The thick concentrated formula of Toilet Bowl Cleaner coats the bowl for better cleaning and targets even the hard to reach areas of the bowl, leaving a lovely fresh scent behind.



**850-01062**

## THETFORD AQUA RINSE SPRAY

A special formula developed for toilets connected to the central water tank of the vehicle. Just spray inside the bowl before or after using the toilet to ensure a smooth flush and a fresh smelling toilet. Aqua Rinse Spray coats the toilet bowl with a special, protective layer which results in a smoother flush and limits the number of flushes required. Available in a 500ml spray bottle.



**850-01073**

## THETFORD AQUA KEM BLUE ZIP BAG SACHETS

Water-soluble toilet sachets for the waste-holding tank.

- > Easy to use: sachets completely dissolve in water
- > Apply the right dose easily
- > Highly concentrated
- > Outstanding odor control
- > Reduces gas build-up
- > Suitable for winter camping
- > Liquefies waste for easier tank emptying
- > 15 sachets



**850-01064**

## THETFORD BATHROOM CLEANER

Cleaning agent for safe, easy and thorough cleaning of all plastic surfaces in caravan or motorhome. Wipe with a damp cloth or rinse with water. For extra shine, polish with a soft, dry cloth. On particularly dirty surfaces, allow the cleaner to work in for a few minutes before cleaning or repeat the process if necessary.



**850-01074**

## THETFORD AQUA KEM GREEN ZIP BAG SACHETS

Water-soluble sachets for the waste-holding tank.

- > Easy to use: sachets completely dissolve in water
- > Septic tank safe (Test ISO 11734)
- > The right dose every time
- > Superior odor control with biological action
- > Liquefies waste for easier emptying
- > Reduces gas build-up
- > 12 sachets (12 x 42.5 gr.)



## THETFORD AQUA KEM LAVENDER

Aqua Kem® Blue Lavender offers the trusted quality Aqua Kem® Blue with a fresh lavender scent. Like the Aqua Kem® Blue (no. 1 toilet additive for mobile toilets world wide), the Aqua Kem® Blue Lavender is a highly effective toilet fluid for the waste-holding tank, that offers the best performance for your Cassette- and portable toilet.

**850-01076**  
**AQUA KEM BLUE LAVENDER**  
**(1L)**

**850-01078**  
**AQUA KEM BLUE LAVENDER**  
**(2L)**



**850-010809**  
**THETFORD GREY WATER FRESH**  
**CONCENTRATED 800ML**

Concentrated toilet fluid for the grey water tank  
Concentrated, strong, effective fluid which prevents nasty grey water smells coming from the drains.

Why choose Thetford Grey Water Fresh Concentrated?

- > Reduces deposit formation in the grey water tank
- > Outstanding grey water odour control
- > Keeps the grey water fresh and clean for longer
- > Odour free discharging of the grey water tank
- > Convenient small bottle.



For both tanks: Empty after at least 16 hours at a designated location.

## THETFORD DUO TANK CLEANER

### CONCENTRATED

**850-01079**  
**THETFORD DUO TANK CLEANER**  
**CONCENTRATED 800ML**

Concentrated periodical cleaner for the waste-holding tank and grey water tank.

Concentrated periodical cleaner that removes scale, encrusting and grease deposits from the waste-holding tank and grey water tank.

Why choose Thetford Dual Tank Cleaner?

- > Removes scale, encrusting and grease deposits
- > No scrubbing required!
- > Technical parts inside the tanks are cleaned as well
- > Prolongs the lifespan of the tanks
- > Convenient small bottle



**850-02500**  
**TOILET TISSUE**

Fiamma soft tissue -made from pure water-soluble wadded cellulose, it won't clog up tanks or waste valves (6 rolls per pack)



**850-02510**  
**TST RV AND MARINE TOILET**  
**TISSUE**

Fast dissolving, clog resistant toilet tissue is biodegradable and septic tank safe! Ply / 4 rolls per bag, 280 sheets per roll.



**850-02522**  
**THETFORD AQUA SOFT 6/PK**  
**2PLY TOILET TISSUE**

A super soft toilet paper that quickly decomposes in your waste tank thus preventing clogging and damage to your waste tank. Each pack contains

6 rolls.

- > Dissolves quickly
- > Prevents clogging
- > Easier to empty waste-holding tank
- > Prevents malfunctions or damage to the waste-holding tank
- > Super-soft toilet paper.



Use in the grey water tank:

1. Add 600ml to the empty tank via the sink or shower drain.
2. Add 50L of luke warm water.
3. Drive with your RV for at least 1h, in order to cover all surfaces of the tank.

For both tanks: Empty after at least 16 hours at a designated location.

## CASSETTE TOILETS

## THETFORD CASSETTES

The built-in Cassette Toilet consists of two parts: a permanently installed toilet and a removable waste-holding tank. A clever indicator lets you know when the tank needs to be emptied, and you can access and remove the tank through a small door (Service Door 3 - 850-01600 or 850-01601) on the outside of the vehicle. Choose from various models. All Thetford Cassette Toilets come with a 3 year warranty.

**C402 - C**

A bench model toilet with integrated water tank and electric flush. The C402 comes with a bigger 19.3Lt waste-holding tank with wheels, to allow for easy emptying.

**Specifications**

Dimensions: 512H x 670W x 400D (mm)

Seating Height: 473mm

Net Weight: 8.1kg

Flushing System: Electric

Capacity of Flush-Water Tank: 15L

Capacity of Waste-Holding Tank: 19.3L (with wheels)

**850-01412**

**C402-C CASSETTE TOILET WITH RIGHT HAND INTERNAL WATER SUPPLY**

**850-01422**

**C402-C CASSETTE TOILET WITH LEFT HAND INTERNAL WATER SUPPLY**



## THETFORD C220 SERIES

Based on the proven concept of the C200, the C220 is a compact Cassette Toilet with high quality functions and a completely new design. The C220 is everything you would expect from a Thetford toilet.

- > Waste-holding tank with wheels
- > User friendly controls
- > Waste-level indicator
- > Contemporary modern design
- > Larger tank (18L)
- > Easy upgrade to C263 Ceramic
- > Higher seating position
- > Larger, deeper bowl

**850-90070N**

**THETFORD C223CS SWIVEL TOILET 12VOLT NO DOOR**

**Specifications**

Dimensions: 534 x 394x 580 mm

Seating Height: 492 mm

Net Weight: 7.2kg

Flushing System: Electric

Capacity of Waste Holding tank: 18L

**850-01570**

**THETFORD CASSETTE TOILET SWIVEL HEAD WHITE ELECTRIC WITH DOOR C223-CS**

**Specifications**

Dimensions: 534 x 394x 580 mm

Seating Height: 492 mm

Net Weight: 7.2kg

Flushing System: Electric

Capacity of Waste Holding tank: 18L

**850-90094N**

**THETFORD C224 SWIVEL MANUAL TOILET WITH WATER DOOR & CASSETTE DOOR**

**Specifications**

Dimensions: 727 x 394 x 580mm

Seating Height: 492 mm

Net Weight: 8kg

Flushing System: Manual

Capacity of Waste Holding tank: 18L

**850-90090N**

**THETFORD C224CW SWIVEL TOILET (NO DOOR)**

**850-01591**

**C263-CS CASSETTE WITH CERAMIC BOWL (NO DOOR)**

The C263-CS with full ceramic bowl is the top of the range in Cassette Toilets. It has a swivel bowl, electric flush and is connected to the central water tank of your vehicle. The waste-holding tank comes with wheels for easier emptying.

**Specifications**

Dimensions: 750H x 417W x 600D (mm)

Seating Height: 479mm

Net Weight: 17.5kg

Flushing System: Electric

Capacity of Flush-Water Tank: n/a

Capacity of Waste-Holding Tank: 17.5L (with wheels)



# CASSETE TOILETS

**850-90050N**

**THETFORD C260CS TOILET WITH LOW BACK (NO DOOR)**

Similar to the C260 Ceramic toilet (previous) with the only difference being that the C260CS has a HD polyethylene toilet bowl making it very lightweight at 7.8kg. It too has an electric flushing system for your convenience and a waste holding tank on wheels. Its compact design allows for optimal use of space inside your RV, not to mention the 900 swivel capability.



**Specifications**

Net Weight: 7.8kg

**850-90060N**

**THETFORD BRAVURA TOILET**

Suitable for RV's that have a permanent waste-holding tank, the Bravura connects to your caravan's central waste tank. It has a single foot pedal flushing system with an extra deep bowl to ensure less splashing. The Bravura is easy to install and is lightweight.



**Specifications**

Dimensions: 454H x 421W x 531D (mm)

Net Weight: 8.3kg

## THETFORD C400 CASSETTES

The built-in Cassette Toilet consists of two parts: a permanently installed toilet and a removable wasteholding tank. A clever indicator lets you know when the tank needs to be emptied, and you can access and remove the tank through a small door on the outside of the vehicle.

- > Highest level of seating comfort on the market
- > Lightweight, high-quality, durable plastic
- > Quiet yet powerful flushing system with full bowl coverage
- > Homelike bowl in size and comfort
- > 3 year warranty



**850-90022N**

**THETFORD C400 TOILET LEFT HAND NO DOOR INCLUDED**

**850-99991**

**THETFORD C400 LEFT HAND NEW TOILET KIT WITH DOOR**

**850-90032N**

**THETFORD C400 TOILET RIGHT HAND NO DOOR INCLUDED**

**850-99990**

**THETFORD C400 RIGHT HAND TOILET KIT WITH DOOR**



**850-93012**

**THETFORD SPARE CASSETTE C223 OUTSIDE VENT**



## THETFORD ACCESSORIES

**850-01592**

**CASSETTE (ONLY) TO SUIT THETFORD C250 AND C263**



**850-93000**

**THETFORD L/H HOLDING TANK T/S C2 CASSETTE ELECTRIC TOILET**



**850-93002**

**THETFORD R/H HOLDING TANK T/S C2 CASSETTE ELECTRIC TOILET**



**850-93004**

**THETFORD HOLDING TANK T/S C200 SWIVEL**



**850-93008**

**THETFORD C220 SPARE CASSETTE ONLY**



# THETFORD TOILET SPARES

## SECTION 7

**850-01624**  
**LEFT-HAND HOLDING TANK**  
**TO SUIT C400 TOILET**

Convenient wheels and remarkable mechanisms for easy cleaning and maintenance (19.3L capacity)



**850-01626**  
**RIGHT-HAND HOLDING TANK**  
**TO SUIT C400 TOILET**



**850-01594**  
**THETFORD CERAMIC SEAT AND LID**  
**TO SUIT C250**



**850-01600**  
**SERVICE DOOR TO SUIT THETFORD**  
**CASSETTE (WHITE)**



**850-01601**  
**SERVICE DOOR (#3) TO SUIT**  
**THETFORD CASSETTE (BLACK)**  
With a pushbutton latch and lock.



**850-01604**  
**DRAIN CAP FOR C2**



**850-01606**  
**SLIDING COVER FOR C2, C200 AND C400**  
**HOLDING TANKS**



**850-01608**  
**THETFORD C200 BLADE**  
**OPENER (YELLOW)**



**850-01610**  
**WHITE SEAT AND LID ASSEMBLY (TO**  
**SUIT C2 CASSETTE TOILET)**



**850-01614**  
**WHITE SEAT AND LID ASSEMBLY FOR**  
**C400**



**850-01616**  
**WHITE SEAT AND LID ASSEMBLY**  
**FOR C200**



**850-01719**  
**THETFORD HOLDING TANK**  
**MECHANISM FOR C250**



**850-01638**  
**RIGHT-HAND SLIDE ASSEMBLY**  
**FOR C400 HOLDING TANK**

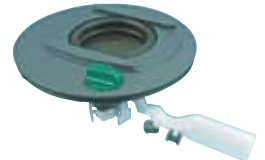

**850-01640**  
**LEFT-HAND SLIDE ASSEMBLY**  
**FOR C400 HOLDING TANK**



## THETFORD TOILET SPARES

850-01644

THETFORD SC234 VENT  
BUTTON YELLOW FOR C200

850-01650

MEASURING CUP ONLY  
FOR CASSETTE HOLDING TANK

850-01652

LIP SEAL OLD TYPE  
(PRE JUNE 2000)

850-01654

LIP SEAL NEW TYPE  
(AFTER JULY 2000)

850-01656

PUMP TO SUIT C2/C402  
CASSETTE TOILET

850-01660

THETFORD YELLOW DUMP CAP



850-01668

THETFORD CONTROL PANEL/  
LEVEL INDICATOR FOR  
C400. 3232062

850-01751

THETFORD ZADI KEY ONLY

Please note that the barrel is sold separately. Once the keys have been purchased, please contact your local Coast team to order the corresponding barrel.



850-01019

THETFORD HOLD DOWN KIT PORTA POTTI  
EXCELLENCE & 565P

850-01708

THETFORD HOLD DOWN KIT BASE FOR PORTA POTTIE

## THETFORD FRESH-UP SETS

The toilet Fresh-Up Set is a simple and economic way to make a used Cassette Toilet as good as new. The set includes a waste-holding tank with a toilet seat and cover, along with the free toilet fluids to freshen up the toilet. You only pay for the waste-holding tank! The toilet Fresh-Up Set is available for Cassette Toilets C2/C3/C4\*, C200, C400\* and C250. Need an additional waste-holding tank for longer trips? Even then the toilet Fresh-Up Set is a perfect solution. \* for left and right models.



850-92134

C200 FRESH-UP SET

850-92130

C2/C3/C4 FRESH-UP SET FOR LH MODELS

850-92132

C2/C3/C4 FRESH-UP SET FOR RH MODELS

850-92138

C250/C260 FRESH-UP SET

## VALTERRA SEWER HOSES

850-01808

VALTERRA 3" X 10' QUICK DRAIN  
SEWER HOSE BLUE BOXED

850-01826

VALTERRA 3" X 20' QUICK  
DRAIN SEWER HOSE BLUE  
BOXED

## VALTERRA SEWER VALVES

850-01904

VALTERRA T18 TWIN SEWER  
VALVE 3" AND 1-1/2"

850-01906

VALTERRA T80 DOUBLE ROTATING  
VALVE ASSY 3" AND 1-1/2"



## VALTERRA SEWER FITTINGS AND HOSE CONNECTORS

**850-01950**  
SLIP HUB 3



**850-01952**  
SPIGOT FLANGE 3



**850-01954**  
VALTERRA F02-2028 3" BAYONET FITTING LUGS X 3" HOSE



**850-01956**  
VALTERRA T1024 3" STRAIGHT ADAPTER (HOOKS X 3" HOSE)



**850-01958**  
VALTERRA T1020 3" ENDCAP WITH BAYONET HOOKS



**850-01960**  
BAYONET END W/FLANGE 3



**850-01964**  
VALTERRA E-Z THREADED STRAIGHT HOSE ADAPTER (F02-3101)

Adapts hose to valve and is self threading, no hose clamps required, works with right-hand or left-hand coiled hose.



**850-01966**  
VALTERRA REP SEAL FOR E-Z (F02-3104VP)



**850-01970**  
VALTERRA F02-3108 E-Z COUPLER BAYONET FITTING



**850-01984**  
VALTERRA CP 1003VP 3" SEWER SLIDE VALVE



## CAMCO SEWER FITTINGS

**850-02100**  
SLIP ON RV STRAIGHT SEWER HOSE ADAPTOR



**850-02110**  
SLIP ON RV INTERNAL SEWER HOSE COUPLER



**850-02120**  
RV TWIST CONNECT KIT  
Connect two hoses quickly for added length, suitable for 3" (76.2mm) sewer hoses.



**850-02130**  
RV 45° SEWER HOSE ADAPTOR



# SEWER FITTINGS

**850-02140**  
**RV STRAIGHT SEWER HOSE ADAPTOR**



**850-02150**  
**RV SEWER HOSE CAP**



## CAMCO STANDARD SEWER HOSES

Created for the occasional RVer.

**850-02300**  
**STANDARD 10FT (3M) RV SEWER HOSE**

- > 12mils of black HTS vinyl
- > compresses to 15.5" (39cm)
- > 7.6cm diameter
- > Comes boxed



**850-02310**  
**STANDARD 20FT (6M) RV SEWER HOSE**

- > 12mils of black HTS vinyl
- > 7.6cm diameter
- > Comes boxed



## CAMCO HEAVY DUTY SEWER HOSES

Created for the seasoned RVer who makes weekend trips during the season.

**850-02350**  
**HEAVY DUTY 10FT (3M) RV SEWER HOSE**

- > Made of brown HTS vinyl
- > 7.6cm diameter
- > Comes boxed



**850-02360**  
**STANDARD 20FT (6M) RV SEWER HOSE**

- > Made of brown HTS vinyl
- > 7.6cm diameter
- > Comes boxed



**850-02362**  
**CAMCO RHINOFLEX 90° TOTE TANK HOSE KIT**

- Connects your portable waste tank to any lug sewer fitting
- > Assembled kit is 3 feet long extended; 19 inches compressed
- > Includes 90 degree translucent elbow with bayonet swivel fitting
- > Fittings provide a secure, odor tight connection
- > Includes 1 storage cap



**850-02364**  
**CAMCO RHINOFLEX 90° TOTE TANK FITTING**

- Designed for use with RV Tote Tanks
- > Low profile 90° elbow for maximum drainage
- > Two swivel bayonet ends
- > Odor tight connection
- > UV stabilized resin



**850-02366**  
**CAMCO RHINOFLEX SWIVEL WRENCH SET**

- Provides leverage for loosening and tightening swivel fittings
- > Compatible with Rhino Revolution
- > Easy Slip and many other bayonet and lug fittings
- > Lightweight and durable
- > Ergonomic design
- > Set of 2



**850-02368**  
**REVOLUTION RV SWIVEL HOSE KIT 3" X 20"**

- Kit is the complete hose kit that comes with everything you need for a quick, reliable hook-up. Features new pre-attached fittings that rotate 360 degrees. Includes two 10 lb heavy duty vinyl sewer hoses with pre-attached swivel lug and swivel bayonet fittings and 4 storage caps. Other features include translucent elbow and wire guards to protect your hands. Patent pending. Also available: 10' Extension with pre-attached swivel lug and swivel bayonet fittings.



**ONLY**  
AVAILABLE IN  
NEW ZEALAND

# TOILET ACCESSORIES

**850-02370**

**EASY SLIP RV SEWER KIT 3" X 10'**

This complete sewer kit comes assembled with everything you'll need for a quick, reliable sewer hook up. Nonrestrictive for free flow and faster dumping. Includes 10' HTS sewer hose, Easy Slip bayonet straight hose adapter and Easy Slip sewer elbow with 4-in-1 adapter.



**850-02820**

**CAMCO RHINO HOLDING TANK CLEANER - 6 PER BAG**

A powerful enzyme that helps clean your holding tank and remove waste from tank walls in less than 24 hours. Simply flush one drop-in per 150 liters of holding tank capacity down your RV toilet and fill 3/4 of the way with water, then let the drop-in do the rest of the work. Regular cleaning of your holding tank helps sensors function efficiently and keep unwanted smells at bay. The easy to use drop-in is pre-measured and safe for septic tanks. For best results, use one drop-in every three months.



**850-02374**

**CAMCO EASY SLIP 4-1 SEWER ADAPTOR**

Easy Slip 4-in-1 Sewer Adaptor with Elbow Connects hose to dump station. The elbow's tapered end accepts all 3" hoses and slip-over fittings. Adapter fits into 3" slip or 3", 3-1/2" and 4" threaded pipe. Larger inside diameter allows for faster dumping. Elbow separates from adaptor for storage in bumper.



**850-02694**

**FIAMMA ADAPTER FLAN**

For Valve for Roll Tanks.



**800-01592**

**FIAMMA ROLL-TANK 40 F - 40L WATER TANK (BLUE)**



**850-02695**

**FIAMMA OUTLET**

For Roll-Tank 40W



**850-02697**

**FIAMMA FLOAT**

For 40L Waste Roll Tank



**850-02600**

**FIAMMA 40LT PORTABLE WASTE TANK**

A 40Lt waste tank with level indicator and air release valve. Comes with a 45° angle adaptor to assist with emptying.

**Specifications**

Weight: 3.9kg

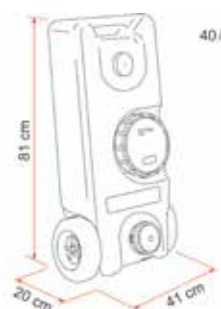

**850-02698**

**FIAMMA TERMINATION CAP AND SMALL TUBE TANK**

To Suit 40L Waste Tank.

**850-02699**

**FIAMMA 3" TERMINATION CAP**

For 40L Portable Waste Tank



# CARAVAN LOO TREATMENT

## CAMCO CARAVAN LOO DROP INS

Camco Caravan Loo Treatment Drop-Ins help control unwanted odors in your waste water holding tank. The easy to use Drop-Ins contain a special and ultra-concentrated formula that helps digest waste, and a blend of fantastic-scented surfactant oils that trap unwanted odors in your tank, making your camping experience more enjoyable. The Drop-Ins are RV and marine approved and safe for all waste holding tanks—they're even great for portable camping toilets! Each bag comes with 15 Drop-Ins.

- > Ultra-concentrated formula, just one sachet treats up to 25L
- > Eliminates odors and lubricates sensors in the RV holding tank
- > RV and marine approved
- > Safe for all waste holding tanks
- > New Lavender scent
- > Easy to use Drop-Ins, 15/bag

**850-02830**

### FRESH SCENT DROP INS



**850-02832**

### LAVENDER SCENT DROP INS



**850-02834**

### PURE RAIN SCENT DROP INS



## CAMCO CARAVAN LOO LIQUID

Camco Caravan Loo Treatment helps control unwanted odors in your waste water holding tank. The easy to use liquid contain a special and ultra-concentrated formula that helps digest waste, and a blend of fantastic-scented surfactant oils that trap unwanted odors in your tank, making your camping experience more enjoyable. The liquids are RV and marine approved and safe for all waste holding tanks—they're even great for portable camping toilets!

- > Ultra-concentrated formula, just 20ml treats up to 10L
- > Eliminates odors and lubricates sensors in the RV holding tank
- > RV and marine approved
- > Safe for all waste holding tanks
- > New Lavender scent
- > 1.89L bottle
- > Friendly to the environment
- > Easy to use
- > Formulated for Australian conditions

**850-02840**

### FRESH SCENT LIQUID 1.89L



**850-02842**

### LAVENDER SCENT LIQUID 1.89L



**850-02844**

### PURE RAIN SCENT LIQUID 1.89L



## TOILET ACCESSORIES

## ODOUR B GONE DEODORISERS

Odour-B-Gone is a tablet form of compressed per-oxy salts; it contains no fillers i.e. it is made of 100% active ingredients. The tablets slowly dissolve in the holding/ waste tank of the portable toilet over a 7 day period, releasing hydrogen peroxide which is known for effective bleaching, deodorising and sanitising.

**850-04052**  
**ODOUR B GONE RV TOILET**  
**DISK - 40PK**

**850-04058**  
**ODOUR B GONE SLOW RELEASE**  
**MINI OXYGEN DISINFECTANT**  
**TABLETS. GREEN 2G - 10 PK**

CASSETTE TOILETS : Simply drop 1 x 8 gram Blue tablet into the bottom cassette with half cup water, lasting up to 4 Days usage. The tablet will break down the matter including the paper very quickly. There are 2 size pouches, 50 x 8gram tablets (blue) & 25 x 8gram tablets both include 10 x 2gram. Mini oxygen tabs for use in a spray bottle.



The 2 gram Mini Tab (green) is used in a spray bottle, simply drop into a 400 mil bottle with cup hot water & top up with cold water, give it a shake and is ready for use. You do not have to wait till the mini tab fully dissolves. We use the spray bottle for the bowl & seat, which only takes seconds & in the heat perhaps spray the bowl 3 times a day. By spraying it is killing the bad bacteria & any odour, it is good to open the slide when spraying to allow entry into the bottom cassette. (You do not have to wait for the Mini Tab to fully dissolve, just use it!)

Use any toilet paper & if it is not breaking down use more flushing water.

**850-04060**  
**ODOUR B GONE FAST RV TOILET**  
**DISK. WHITE 30G - 20PK (PLUS**  
**10X2G MINI OXYGEN TABS)**

HOLDING TANKS: - Depending on the size of the tank I recommend using 1 x 30 gram tablet (white) for 7 days usage , add more as required. The tablet is similar to the 8 gram but more economical for such tanks. If you have a boat/yacht etc sea water can be used and with a Masurator suggest crush the tablet install pieces to prevent from jamming. If you have the small bottle Mini tabs enclosed in your packaging I suggest use the same method as shown above for the bowl & seat.



The Mini Oxygen Tab in a spray bottle lasts around 3 weeks can be used in the kitchen, Bathroom on bench tops etc and has NO perfume. (You do not have to wait for the Mini Tab to fully dissolve, just use it!)

GREY WATER: I recommend using the 30 gram tablet can be placed on the far corner of the shower base , this will clean out the pipe lines leading to the tank, also can be placed directly into the tank.

## ODOUR B GONE PLUS - RV TOILET TABLETS

CASSETTE TOILETS : Simply drop 1 x 8 gram Blue tablet into the bottom cassette with half cup water, lasting up to 4 Days usage. The tablet will break down the matter including the paper very quickly.. Mini oxygen tabs for use in a spray bottle.



The 2 gram Mini Tab (green) is used in a spray bottle, simply drop into a 400 mil bottle with cup hot water & top up with cold water, give it a shake and is ready for use. You do not have to wait till the mini tab fully dissolves. We use the spray bottle for the bowl & seat, which only takes seconds & in the heat perhaps spray the bowl 3 times a day. By spraying it is killing the bad bacteria & any odour, it is good to open the slide when spraying to allow entry into the bottom cassette. (You do not have to wait for the Mini Tab to fully dissolve, just use it!)

Use any toilet paper & if it is not breaking down use more flushing water.

**850-04062**  
**ODOUR B GONE PLUS - RV TOILET TABLETS BLUE 8G**  
**- 50 PACK (PLUS 10X2G MINI OXYGEN TABS)**
**850-04064**  
**ODOUR B GONE PLUS - RV TOILET TABLETS. BLUE 8G**  
**- 25 PACK (PLUS 10X2G MINI OXYGEN TABS)**

**850-04066****ODOUR B GONE PLUS - RV  
TOILET TABLETS. BLUE 8G - 10  
PACK**

CASSETTE TOILETS : Simply drop 1 x 8 gram Blue tablet into the bottom cassette with half cup water, lasting up to 4 Days usage. The tablet will break down the matter including the paper very quickly.



Use any toilet paper & if it is not breaking down use more flushing water.

**850-04102****HAPPY BOWL TOILET BOWL LINERS  
- 50 PER PK**

No fuss, no brush! Happy Bowl liners are designed specifically for caravan and motorhome toilets and porta potties.



These bio-degradable toilet bowl liners are hygienic, eliminate toilet brushes, minimize water usage and keep your bowl sparkling clean and streak free.

Safe for septic tanks! (50 per box)







# SECTION 8

## TV EQUIPMENT

(Product Group - 900)

Winegard Antenna and Spares	304 - 307
Antennatek Spare Parts	308 - 309
Foldaway Antenna and Accessories	309
Happy Wanderer Antenna and Spares	309 - 310
Signal Boosters	310
Furion Visions	311
Reversing Cameras	311 - 314
Sphere™ Entertainment	315 - 317
Sphere™ Cables and TV Fittings	318 - 319
Sphere™ Satellite	321 - 322
Sphere Wifi Routers	323
Fusion Entertainment	324
Furion Audio/Visual Entertainment	325 - 328

---

## WATER HEATERS

(Product Group - 950)

Suburban HWS Range	329 - 332
HWS Maintenance Accessories	333 - 335
Suburban Nautilus HWS and Accessories	336 - 339

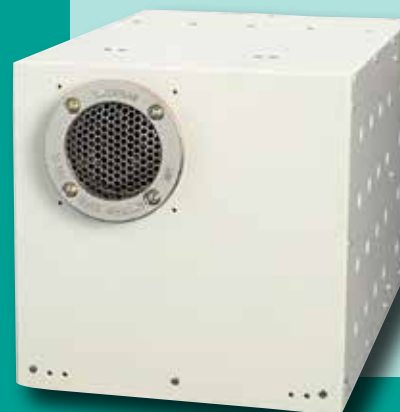
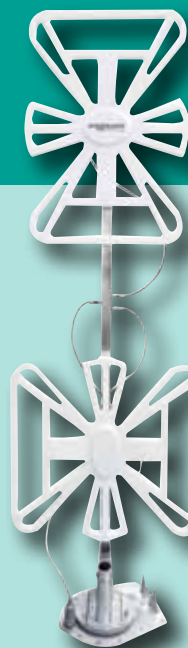

## WINEGARD SENSAR HV ANTENNA



Catch all of your favourite TV shows on your next RV adventure with the Winegard Sensar HV Antenna. This revolutionary bi-directional antenna receives both horizontal and vertical signals, allowing you to pick up a wider range of free-to-air channels on your RV's TV. Made in the USA, this robust antenna receives analogue, SD and HD signals. Never miss out on the footy grand final again - enquire about a Winegard Sensar HV today!

**900-00050  
(BULK PACK) WINEGARD SENSAR  
HV ANTENNA**

A new and innovative antenna that receives both horizontal and vertical digital signals allowing for reception in more areas. It features two independently amplified antennas to deliver maximum digital VHF/ UHF programming. Made in the USA, this bidirectional antenna receives analogue as well as standard and HD digital signals and has been designed to fit roofs from 2.5cm - 12cm thick. The OEM pack contains x4 Sensar HV Antenna kits which include: antennas mounted on the reliable crank-up lift turret assembly, a white on/ off power supply switch, hardware, 6.1mt coax cable and a 139.7cm coax cable. RCM certified. The Winegard Sensar HV comes with a 1 year limited warranty, covered by Coast.

**900-00060  
(SINGLE BOX) WINEGARD  
SENSAR HV ANTENNA**

Has all the same features as the OEM pack (i.e. comes with complete antenna/ lift assembly, white on/ off wall plate and power supply switch, coax cables and mounting hardware) except that it is sold singularly.

**Specifications 4G Filter**

Range: 144km

Operating Voltage: 12V DC

Operating Dimensions: 43.2W x 116H (cm)

Stowed Dimensions: 125.3L x 11.2H (cm)

Weight: 3.13kg

## ANTENNAE

**900-00070****WINEGARD SENSAR HV ANTENNA RETROFIT KIT (WITH HEAD AND MAST)**

This allows you to replace the amplified head on an existing Winegard antenna with the Sensar HV bidirectional head.\* It can also be used to replace the heads on Antennatek antennas as the old elevating gear can be used.

\* Please check the roof clearance prior to purchasing the Sensar HV Retrofit Kit (refer to diagram, showing minimum roof top space required)

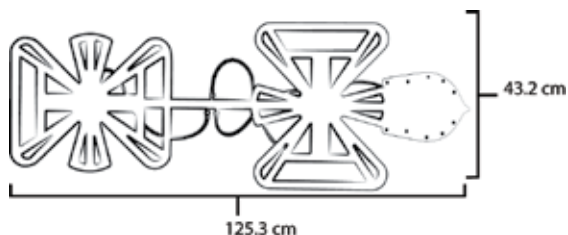
**900-00360****WINEGARD WHITE 12V POWER SUPPLY (FOR TV ANTENNA)**

A replacement part for a standard Winegard kit (i.e. a Winegard without a Sensar Pro).

**900-00364****WINEGARD WHITE 2ND TV WALL PLATE ONLY**

A convenient TV outlet with 75ohm coax cable input and output. It has a (+) 12V DC receptacle and easily surface mounts onto a wall.

**WINEGARD RVH 3095 SENSAR RV TV ANTENNA W/POWER SUPPLY**
**900-00010****RV-3095 ANTENNA**

The Sensar RV-3095 antenna has a built in amplifier and unique circuitry that gives you clear VHF/ UHF reception wherever you park your RV. Easy to install, and is bidirectional and corrosion resistant. Digital ready when combined with digital off-air tuner or HD digital television.

**900-00014****(BULK PACK) WINEGARD ANTENNA**

Winegard antenna same features as RV3095 supplied in bulk pack (Sold in packs of 4). Digital ready when combined with digital off-air tuner or HD digital television. Full range of spare parts available from any Coast branch.

**900-00372****WINEGARD SENSAR PRO**

Designed, built and hand tested in the USA, the Sensar Pro allows you to find the highest signal strength and thus watch TV. It has an adjustable amplifier which provides up to 10dB for increased performance if needed.

**Specifications**

Dimensions (cm): 11.4H x 7W x 1.9D

Weight (g): 81.6

Cables/Outputs included: Antenna IN, Cable IN, TV1 OUT and TV2 OUT

**900-00400****WINEGARD DIRECTIONAL HANDLE EXTENSION**

Used to extend the directional handle on leisure vehicles with a thicker roof. Roof thickness in excess of 4.75" (120.65mm) and up to 7" (177.8mm) would require an extension. (The handle and extension should be glued together after checking that you have the correct handle. The handle will not work properly if it is not glued together.)

**900-00410****WINEGARD WINGMAN**

This lightweight attachment (suitable for Winegard antennae only) attaches to the Sensar head and increases the digital UHF reception by up to 100%. Available in white, it acts as a digital booster. There are no wires to connect and no tools required for installation. The Wingman allows you to improve your Winegard Sensar's performance, enabling you to enjoy more free-to-air HD channels as it is optimised for digital and HD programming. The elements are powder coated to protect against the elements and rust. Note: The Wingman helps with UHF channels only and must be installed facing forward.

**Specifications**









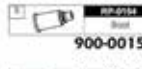
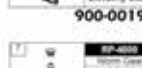

Dimensions: 419.1W x 355.6D x 35.6H (mm)

Weight: 0.45kg

**900-00422**  
RD 55" COAX ASSEMBLY FOR THE  
H/V ANTENNA

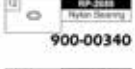
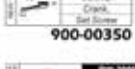

**WINEGARD SPARES**

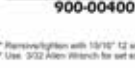
 <b>900-00110</b>	<b>RV-2005</b> Angled Antenna Head 18.0cm
 <b>900-00202 (27" Tube)</b>	<b>RP-3900</b> 2 Seals 2 Conicals 4 Pins 4 Resisting Rings Rubber Bungler Self Poling
 <b>900-00150</b>	<b>RP-0154</b> Boot
 <b>900-00190</b>	<b>RP-3000</b> Elevation Gear
 <b>900-00220</b>	<b>RP-4000</b> Worm Gear & 1/2 21" Max Elevating Shaft Assembly w/ Wave Washer Tail Washer V-Ring Worm Gear Nut
 <b>900-00230</b>	<b>PACKAGE MODEL NO.</b> <b>RP-2049</b> Gear Housing 2 Pins Bearing Nut Spring O-Ring Seal Retaining Ring
 <b>900-00260</b>	<b>RP-2022</b> Line Post 10 Screws Plastic Boot
 <b>900-00300</b>	<b>RP-3000</b> Elevation Gear 4 Screws Spring Denal
 <b>900-00320</b>	<b>RP-4022</b> Spring
 <b>900-00340</b>	<b>RP-3000</b> Nylon Bearing
 <b>900-00350</b>	<b>RP-4700</b> Worm Gear Crank Self Screw
 <b>900-00380</b>	<b>RP-3000</b> Roof Mounting
 <b>900-00400</b>	<b>RP-1030</b> Directional Handle Extension

\*\* Retain/replace with 10/16" 1/2 socket  
\*\* Use .532 Allen Wrench for set screw

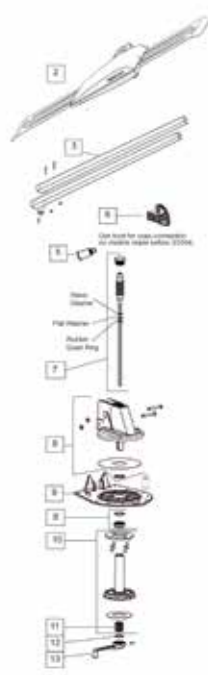

**SENSAR HV SPARE PARTS**

Sensor HV Spare Parts			
<b>900-00150</b>		<b>900-00340</b>	
<b>RP-0154: Boot</b>		<b>RP-2058: Nylon Bearing (for Crank)</b>	
Part Description	Quantity	Part Description	Quantity
Boot (light gray)	1	Nylon Bearing	1
<b>900-00230</b>		<b>900-00190</b>	
<b>RP-2049: Gear Housing Assembly</b>		<b>RP-3000: Elevation Gear</b>	
Part Description	Quantity	Part Description	Quantity
Gear Housing	1	Elevation Gear	1
Pin	2		
Nylon Nut	1		
Nylon Bearing (for gear housing)	1		
E-Clip	2		
O-Ring	1		
Nylon Bearing (for base plate)	1		
<b>900-00260</b>		<b>900-00350</b>	
<b>RP-3523: Base Plate</b>		<b>RP-4700: Crank (White)</b>	
Part Description	Quantity	Part Description	Quantity
Base Plate	1	Crank (white)	1
Mounting Screw	10		
Light Gray Boot	1		
<b>900-00220</b>		<b>900-00300</b>	
<b>RP-4000: Worm Gear Assembly</b>		<b>RP-6300: Directional Handle &amp; Ceiling Plate (White)</b>	
Part Description	Quantity	Part Description	Quantity
Worm Gear	1	Spring	1
Plug	1	Decal	1
Manual	1	Ceiling Plate (white)	1
		Directional Handle (White)	1
		Screw	4
		Elev Shaft & Worm Gear Repl. Manual	1
<b>900-00070</b>		<b>900-00320</b>	
<b>CC-25RV: Retrofit Kit (Head Only)</b>		<b>RP-6822: Spring</b>	
Part Description	Quantity	Part Description	Quantity
Antenna Decal	1	Spring	1
CC-25RV Manual	1		
Boom Assembly	1		
55" Coax Assembly	1		

Updated: 29.01.2014

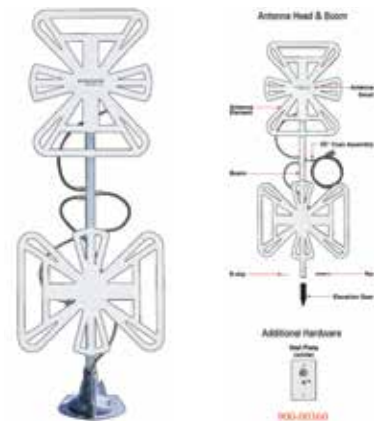

**900-00392**  
WINEGARD 4 CABLE ENTRY PLATE



**900-00394**  
WINEGARD 2 CABLE  
ENRTY PLATE

Weatherproof entry for multi-conductor cable,  
to be used with dual coax systems.



## ANTENNAE

900-04156

CABLE ENTRY PLATE FOR WINEGARD  
SATELLITE DISH

900-07318

FREEVIEW DECODER  
WITH CARD READER

The smallest, most powerful high definition free to air satellite receiver available on the market.



Can be used either horizontally or vertically. USB2 port to attach USB hard drives etc. for updating firmware, channels lists and also recording and pausing live TV.

Built in Infra-Red sensor, allows the box to be hidden in a cupboard and just point the remote at the remote sensor to change channels and volume.

Ideal for the motorhome/caravan etc.

- > No tuning required
- > Factory set for 10750 LNB
- > Full instruction manual
- > Fully upgradable via software
- > Dimensions: 162W X 115D X 30H (mm)
- > Weight: 200 gm.

## TELESAT HD TVS WITH FREEVIEW

Designed specifically for New Zealand, these TVs feature a built-in DVD player, DVB-S2 and DVB-T tuners, a CI slot for a Skycard adaptor and numerous inputs including: USB, SD, AV, HDMI and headphone.



## Specifications

**Tuner Type:** DVB-S/ DVB-S2 and DVB-T/ MPEG2/ MPEG4 (H.264)

**Common Interface Support:** x1 CI slot (certain cards only)

**EPG:** Full 70day EIT EPG for Freeview

**Software Support Update:** USB

**Remote Control:** Yes (included)

**Power:** 12V/240V (Adaptors included)

**Warranty:** 2 Years

900-07400

## 19" HD TV/DVD TELESAT WITH FREEVIEW

900-07402

## 24" HD TV/DVD TELESAT WITH FREEVIEW

900-30010

## 24" TELESAT SMART TV

SPARE PARTS AVAILABLE TO SUIT WINEGARD  
DS5 CRANK UP SATELLITE

900-07106

## DIGITAL WALL PLATE DISPLAY



900-07114

## CRANK HANDLE KIT



900-07112

## DIRECTIONAL HANDLE KIT



900-07110  
46CM REFLECTOR  
FOR RP-35RM



900-07118  
WORM GEAR ONLY FOR  
RP-4400



900-07130  
WINEGARD ELEVATING  
GEAR ONLY



900-07132  
WINEGARD SAT DISH WIRING  
HARNESS



900-07134  
WINEGARD HARDWARE PKG  
FOR ANTENNA TURRET



900-07200  
TRIAx 10750 SINGLE LNB  
FOR WINEGARD DS5



900-07202  
LNB HOLDER ONLY FOR  
WINEGARD DS5



### ANTENNATEK SPARE PARTS

900-01102  
ANTENNATEK AMPLIFIED  
HEAD SERIES 550



900-01114  
ANTENNATEK POWER SUPPLY  
12V W/3 TV OUTLETS



900-01122  
ANTENNATEK ALUMINIUM GEAR  
HOUSING FOR 350



900-01124  
ANTENNATEK 7/8 HEX  
NYLON PLUG FOR GEAR  
HOUSING



900-01140  
ANTENNATEK GEAR  
REPLACEMENT KIT C/W  
WORM GEAR & ELEV  
SHAFT



900-01142  
ANTENNATEK 350  
ELEVATING SHAFT ASSY



## ANTENNAE

**900-01150**  
**ANTENNATEK ELEVATING**  
**HANDLE ASSY**



**900-01160**  
**ANTENNATEK ROTATION**  
**HANDLE**



**900-01162**  
**ANTENNATEK SPRING FOR**  
**ROTATION HANDLE**



**900-01170**  
**ANTENNATEK LARGE**  
**O-RING 1"**



**900-01190**  
**ANTENNATEK BASE**  
**PLATE**



**900-01260**  
**ANTENNATEK DIRECTIONAL**  
**HANDLE KIT**

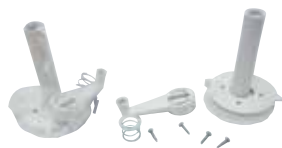

### FOLD AWAY ANTENNA

**900-02350**  
**STANDARD CARAVAN TV**  
**ANTENNA**

Digital ready when combined with a digital TV and set top box. Comes with 4m of cable.



**900-02352**  
**LARGE CARAVAN TV ANTENNA**  
 Digital ready when combined with a digital off-air tuner and HD TV. Comes with 6m of cable.



**900-02374**  
**FOLDAWAY DIRECT**  
**CONNECTOR**

Direct Connector - Enables the antenna to be plugged directly into your TV, thus ending corroded/dusty and worn out connections. It is simple to use and stops signal-sapping joins, which can result in signal drop outs.



**900-02376**  
**MOUNTING KIT**

Includes top clip, bottom bracket and required screws.



**900-02377**  
**MOUNTING KIT TOP CLIP ONLY**  
 Includes x1 top clip and x2 screws



### HAPPY WANDERER MASTS

**900-02382**  
**MULTIFIT BRACKET AND MAST**

Suitable for use with the DT8 Dual Loop antenna range and Stand "T" antenna head. It can be fitted to your RV in a permanent or temporary manner. The permanent option fits all types of RVs including pop tops, caravans, motorhomes, slide-ons and campers. The temporary option fits pop top vans and campers with side travel clamps fitted (the clamps are used when the roof is raised). The mast is 1.4m in length (supplied as x2 70cm lengths that can be joined together via a coupling).



**900-02384**  
**EXTENSION MAST (0.7M) AND COUPLING**

Used in conjunction with part #900-02382, the extension mast is available for campervans with high lifting rooves.



**900-02388****HAPPY WANDERER THRU-VAN-WALL COAX CABLE CONNECTION**

A waterproof, permanent solution to trailing TV antenna cables around your caravan. Made in Australia, it is ideal for use with digital set top boxes, Happy Wanderer Antennae and signal boosters as well as other branded antennae. It is adjustable to suit RV wall thicknesses from 22-35mm. Comes with rubber caps to keep out moisture.

**900-02408****SIGNAL BOOSTER AND POWER PACK (240V/ 12V COMBINATION)**

It has a masthead type booster for use inside your RV. A 12V cable is included for use with a 12V power supply and the booster can be bypassed if it is not required. VHF max 15dB and UHF max 24dB gain.

**900-02390****HAPPY WANDERER T-BAR ANTENNA**

Simple to erect and stow away, the T-Bar Antenna tunes into both horizontal and vertical signals. It picks up UHF/VHF, FM Radio and digital signals and can be used in conjunction with the Signal Booster.

**900-02410****EASY-TUNE**

Easy-Tune is a combined signal finder and amplifier booster. Plug your antenna into the Easy-Tune and use it to show which direction the strongest signal is coming from. Then using the handy LED indicators, the amplifier gain can be adjusted to fine tune your TV. The Easy-Tune can be permanently fixed inside your RV (perhaps inside a storage compartment). It is designed to show the presence and signal of digital or analogue TV signals and is also able to boost the received signal and distribute it to 2 outlets.



*Note: you should never connect 240V AC (mains voltage) directly to the Easy-Tune.*

**900-02396****PART A MULTI FIT BRACKET ONLY FOR HAPPY WANDER****900-02398****PART B MULTI FIT BRACKET ONLY FOR HAPPY WANDER****900-02403****HAPPY WANDERER DT-8 MARK 3 ANTENNA**

The happy viewing continues with the improved DT-8 Mark 3 antenna. It now features an integrated diplexer which means it can combine UHF and VHF signals. The Tapered Loop Technology provides the Mark 3 with a generous beam width of 70 degrees. It is now much easier to set up and the cables cannot be fitted the wrong way. Made from UPVC plastic, the Mark 3 receives low powered DTV stations, as well as HD digital horizontal and vertical signals. It comes with a digital Thru-Van-Wall kit, all cabling (which are RG6 compression with non-corrosive plugs) and a zippered carry bag. Happy Wanderer offer a 5 year warranty on the Mark 3. Note: Brackets and masts are sold separately. You will need to retune your RV TV to suit each locations' reception.

**900-02602****TELESCOPIC CLAMP**

A frame clamp for telescopic pole

**Specifications**

VHF MHz: channel 6-12

UHF MHz: channel 28-69

Max Gain: 10.4dBi (UHF), 3.1dBi (VHF)

Dimensions (mm): 500H x 295W x 165D (with antenna rods not extended)

**Specifications**

Operating Voltage: 10.5 - 28V DC, 250mA max

Outlets: 2

Variable Gain: 5 - 19dB

Dimensions: 16.5W x 5.5D x 2.7H (cm)

Weight: 125g



# REVERSING CAMERAS

## FURRION VISION S REAR-VISION CAMERA & DISPLAY KIT

New from Furrion, the Vision S wireless reversing camera is a high-performance vehicle observation system designed for the road as much as it was for the campsite! From reversing to changing lanes this wireless camera kit keeps an eye out for your RV!

The rear-vision cameras give you a full range of view on a mountable touch screen monitor for smoother mobility while you're travelling or reversing your RV or caravan.



- > Observation systems are wireless with high-resolution touch screen monitors that can show up to four different camera images.
- > IP65 waterproof cameras
- > Rear assist reversing lines
- > 2.4GHz wireless communication digitally locks to the camera system for minimal interference.
- > Cameras offers 120-degree viewing angle, with infrared night vision.
- > The monitor can be mounted with the included windshield or universal surface mount.
- > 5" and 7" touch screen anti-glare monitors with rear assist marker lines.

### 900-02900 FURRION VISION S REAR-VISION CAMERA & 7" DISPLAY KIT

### 900-02902 FURRION VISION S REAR-VISION CAMERA & 5" DISPLAY KIT

## FURRION VISION S 2X SIDE CAMERAS WITH LIGHTLESS BRACKETS

Optional side camera kit for the Furrion Vision S system to provide side vision on the caravan.

#### Features

- > Optimal viewing angle
- > Infrared night vision
- > 720x480
- > Camera resolution
- > Intelligent IR cut filter
- > Motion detect
- > Waterproof ip65
- > Blind spot turn signal

#### Specifications

Night Vision Distance: <39.37ft (12m)  
CMOS Size: 1/3"  
Optical Lens: F2.5  
IR Cut Filter: 850nm Automatic  
View Angle/Degree: 65°  
Working Current (IR ON): <500mA@12V  
Working Current (IR OFF): <250mA@12V  
Camera Pixel: 720 x 480  
Waterproof: P65

### 900-02912 FURRION VISION S LIGHTLESS CAMERA BRACKETS WITH DUMMY COVER (L/H & R/H SET)



## SPHERE REVERSING CAMERA KITS

### 900-02676 MOTORHOME REVERSING CAMERA KIT (WITH WHITE CAMERA)

Featuring a 7", full colour monitor (which clips onto your existing rearview mirror) and a white eyeball camera. When not being used, the monitor can be used as a normal rearview mirror. The kit includes: x1 7" monitor, x1 white eyeball camera, x1 20mt extension cable. Comes with a 1 year manufacturer's warranty. Should a second camera be required, please also order 900-02770.



### 900-02672 CARAVAN REVERSING CAMERA KIT

Includes: x1 white eyeball camera, x 1 7" colour monitor, x1 6mt cable, x1 20mt cable, x1 spring cable and x2 connector brackets. Comes with a 1 year manufacturer's warranty. Should a second camera be required, please also order 900-02771.



## REVERSING CAMERAS

**900-02678****MOTORHOME REVERSING CAMERA KIT (WITH BLACK CAMERA)**

Featuring a 7", full colour monitor (which clips onto your existing rearview mirror) and a black eyeball camera. When not being used, the monitor can be used as a normal rearview mirror. The kit includes: x1 7" monitor, x1 black eyeball camera, x1 20mt extension cable. Comes with a 1 year manufacturer's warranty. Should a second camera be required, please also order 900-02773.

**900-02786****SPHERE 6M LOOM T/S REVERSING CAMERA****900-02674****CARAVAN REVERSING CAMERA KIT**

Includes: x1 black eyeball camera, x1 17" colour monitor, x1 6mt cable, x1 20mt cable, x1 spring cable and x2 connector brackets. Comes with a 1 year manufacturer's warranty. Should a second camera be required, please also order 900-02773.

**900-02771****DUAL CAMERA WIRING KIT**

Includes: x1 white eyeball camera, x1 video split cable. Comes with a 1 year manufacturer's warranty.

**900-02773****DUAL CAMERA WIRING KIT**

Includes: x1 black eyeball camera, x1 video split cable. Comes with a 1 year manufacturer's warranty.

**900-02774****SPHERE CURLY CORD KIT 3M FOR CARAVAN REVERSING KIT****900-02776****SPHERE MINI CAMERA T/S REVERSE MONITOR C/W 1 CAMERA 3M LOOM AND Y-SPLITTER LOOM****900-02785****SPHERE MONITOR LOOM T/S REVERSING CAMERA**

To suit 9pin monitor connection



## SAFETY DAVE

**900-02810****7" MOTORHOME REVERSING CAMERA SYSTEM**

Ideal for motorhomes, the package includes:

- > A 7" LCD screen with sun shield to reduce glare
- > An eyeball camera - fully waterproof and carries audio, video, and night vision infrared.
- > A 15m 4-pin cable - waterproof, carries audio, video and power.
- > A suction mount - enables you to mount your screen onto the dashboard, connects to the windscreen or any other area that allows the cup to work



(Monitor has the capacity to accept a second video input)

**900-02820****5.8" CARAVAN REVERSING CAMERA SYSTEM**

Ideal for caravans and horse floats, the package includes:

- > A 5.8" LCD screen with sun shield to reduce glare
- > An eyeball camera - fully waterproof and carries audio, video, and night vision infrared.
- > A 15m 4-pin cable - waterproof, carries audio, video and power.
- > A 7.5m 4-pin cable - waterproof, carries audio, video and power.
- > A suction mount - enables you to mount your screen onto the dashboard, connects to the windscreen or any other area that allows the cup to work



(Monitor has the capacity to accept a second video input)

**900-02822****CAMERA & 15MT CABLE ONLY FOR REVERSING SYSTEM ROUND WHITE****900-02824****CAMERA FOR LICENSE PLATE MOUNT**

**900-02826**  
CCD BULLET EYE CAMERA



**900-02830**  
CABLE 7.5M FOR REVERSING SYSTEM



**900-02832**  
CABLE 10M FOR REVERSING SYSTEM

**900-02833**  
SAFETY WOZA CABLE FOR CAMERA

A 5-pin heavy duty and flexible cable providing easy connection between vehicles and trailers. Carries audio, video, power and is waterproof.



# SPHERE™ 360° VIEW SYSTEM

## SPHERE 360 DEGREE BIRDSEYE VIEW SYSTEM

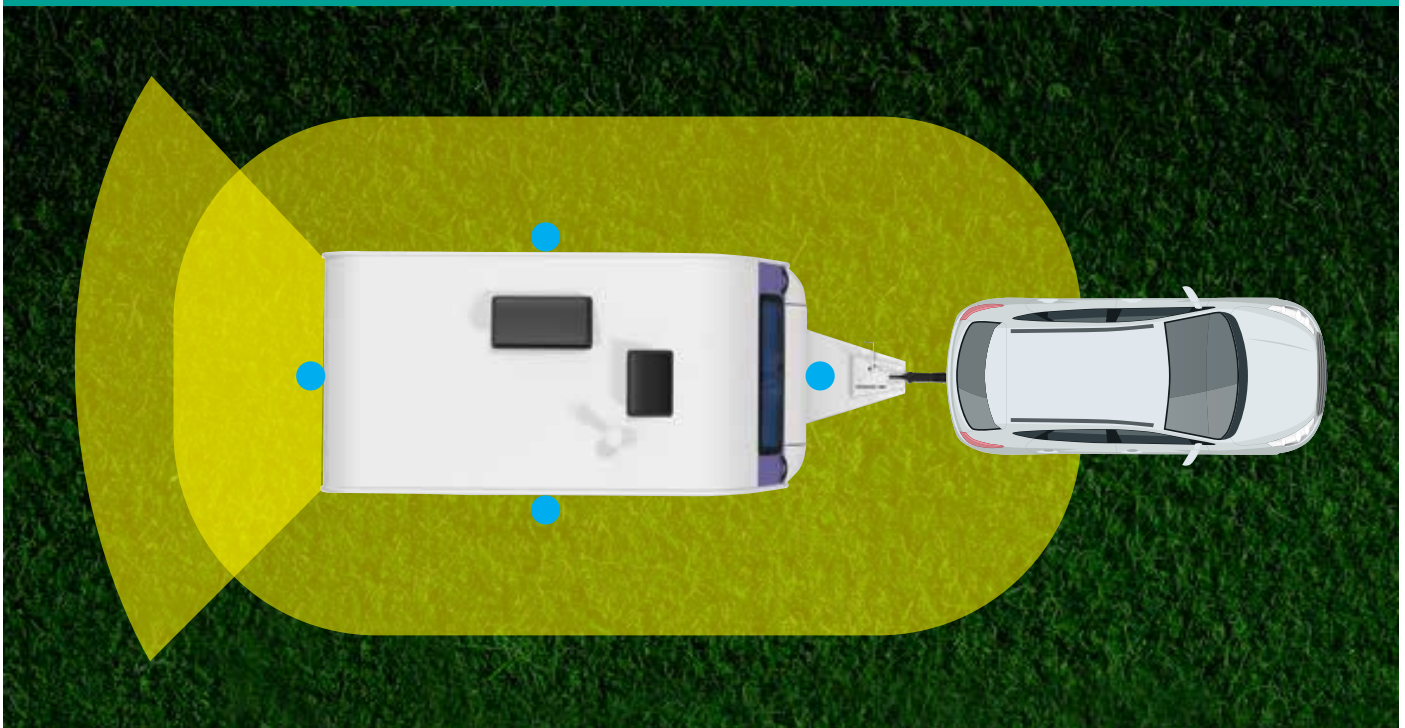

Sphere 360-degree cameras gives you a complete view of your RV, making towing and parking a breeze.

The SPHERE 360-degree Bird's Eye View system uses the inputs of four wide angle fish-eye cameras (front/rear/left/right) installed around the RV to produce a single image. The driver can intuitively observe the vehicle position and surrounding objects to assist in decision making whilst driving and towing the RV to reverse and merge lanes.

The system can also be used as a Digital Video Recorder by inserting a USB to allow continuous recording whilst driving.

### 900-02950

#### SPHERE 360 DEGREE BIRDSEYE VIEW SYSTEM

##### Features

- > Four cameras with 180° fish-eye lens cameras to capture surrounding objects
- > 360° stitching of the 4 input cameras
- > Able to be calibrated to large variety of vehicle/RV sizes
- > System displays the 360° Bird's Eye-View image and:
  - Front camera during normal operation
  - Rear camera whilst reversing
  - Left camera when left indicator is engaged
  - Right camera when right indicator is engaged
- > The system can operate as a Digital Video Recorder (DVR) when a USB is inserted into the control module loom. Once the storage device is full, the system will begin to write over older files. These files can be viewed by inserting the USB into a laptop.



##### Specifications

###### CENTRAL CONTROL MODULE

CPU: Quad-core Cortex™-A7

FLASH: 4GB

Language Options: English, Russian, Japanese, Korean, Portuguese, German, Chinese, Chinese traditional.

Working Voltage Range: 9~36v

Working Current: <400mA

Standby Current: <40mA

Working Temperature Range: -30°C~ 80°C

Working Humidity: 40%~80%

###### CAMERAS

Effective Pixels: 1280(h) x 960(v)

Horizontal Resolution: 960H

Dynamic Range: >78dB

Video Output: AHD

Waterproof: IP67

Video Resolution: 2560 x 1440

Working Voltage: 3.3v

Working Current: <100mA

### 900-02960

#### SPHERE 360 DEGREE CAMERA CALIBRATION MAT SET

# SPHERE™ TV BRACKETS

## SPHERE TV BRACKETS

### 900-03800 SPHERE S2 BLACK SINGLE ARM TV BRACKET

The head can be tilted in all directions and has a 360° rotation capability. Nolathane bushes allow for a smooth gliding action. The arm extends up to 282mm and features a lock to limit movement whilst travelling.



#### Specifications

Weight Capacity: 15kg

Weight: 1.65kg

### 900-03810 SPHERE S2 BLACK DOUBLE ARM TV BRACKET

The head can be tilted in all directions and has a 360° rotation capability. Nolathane bushes allow for a smooth gliding action. The arm extends up to 422mm and features a lock to limit movement whilst travelling.



#### Specifications

Weight Capacity: 15kg

Weight: 1.92kg

### 900-03820 SPHERE S2 BLACK TRIPLE ARM TV BRACKET

The head can be tilted in all directions and has a 360° rotation capability. Nolathane bushes allow for a smooth gliding action. The arm extends up to 562.2mm and features a lock to limit movement whilst travelling.



#### Specifications

Weight Capacity: 9.5kg

Weight: 2.17kg

### 900-03850 SPHERE S2 BLACK LOCKING ARM ONLY



### 900-03852 SPHERE S2 BLACK WALL MOUNT BRACKET

This newly designed mounting bracket makes it easy to setup multiple viewing areas in your RV. It allows for the easy removal of the V arm which can then be relocated and easily placed into any additional mounting brackets that have been installed.



### 900-03856 SPHERE S2 BLACK MOUNTING BRACKET AND VESA PLATE

Mount Your TV direct to the wall of your RV with this kit. Comes with a vesa plate, bracket and necessary screws.



### 900-05837 SPHERE™ VESA 100X100 M4 TO 200X100 M6 CONVERSION BRACKET

This conversion bracket/adaptor is mainly for use with the 31.5" Onyx TV (part number 900-05416) if it is to be used in conjunction with a current Sphere™ silver or black wall mount bracket. Supplied with screws.



#### Specifications

Dimensions: 242L x 21W (mm)

### 900-05770 RUBBER AM/FM ANTENNA WITH 72" CABLE

Receives radio signals for better clarity whilst travelling. It has a 14" (35.6cm) durable rubber antenna and comes with an extension for thicker rooves. The base can swivel 180°.



#### Specifications

Cable included: 182.9cm

## SPHERE™ EKON TV BRACKETS

**900-03801****SPHERE EKON QUICK RELEASE BLACK TV BRACKET KIT - STANDARD SWIVEL****Features**

- > Quick clip wall bracket
- > Pin-lockable
- > In built level
- > Tv cord clips

**Specifications**

Suggested Screen Sizes: up to 26"  
 MAX VESA: 100 mm x 100 mm (max)  
 Maximum Load: 20kg  
 Tilt Range: 13.8° up/13.8° down  
 Pan/Swivel Range: 360° rotation /120°swivel

**900-03821****SPHERE EKON QUICK RELEASE BLACK TV BRACKET KIT - THREE ARM SWIVEL****Features**

- > Quick clip wall bracket
- > Pin-lockable
- > In built level
- > Tv cord clips

**Specifications**

Suggested Screen Sizes: up to 26"  
 MAX VESA: 100 mm x 100 mm (max)  
 Maximum Load: 15kg  
 Tilt Range: 13.8° up/13.8° down  
 Pan/Swivel Range: 360° rotation /120°swivel

**900-03802****SPHERE EKON QUICK RELEASE BLACK TV BRACKET KIT - ONE ARM SWIVEL****Features**

- > Quick clip wall bracket
- > Pin-lockable
- > In built level
- > Tv cord clips

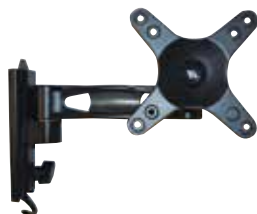
**Specifications**

Suggested Screen Sizes: up to 26"  
 MAX VESA: 100 mm x 100 mm (max)  
 Maximum Load: 15kg  
 Tilt Range: 13.8° up/13.8° down  
 Pan/Swivel Range: 360° rotation /120°swivel

**900-03823****SPHERE EKON BASE ONLY (PART H.)****900-03811****SPHERE EKON QUICK RELEASE BLACK TV BRACKET KIT - TWO ARM SWIVEL****Features**

- > Quick clip wall bracket
- > Pin-lockable
- > In built level
- > Tv cord clips

**Specifications**

Suggested Screen Sizes: up to 26"  
 MAX VESA: 100 mm x 100 mm (max)  
 Maximum Load: 15kg  
 Tilt Range: 13.8° up/13.8° down  
 Pan/Swivel Range: 360° rotation /120°swivel

## SPHERE™ S7 TVS



Built tough for Australian conditions, the Sphere S7 range features a Vibration Smart design specifically intended for Australian RV applications. The range comes with an easy to use remote with one-touch digital tuning and the base can be removed for wall or TV arm mounting. It runs on 12v or 240v with the supplied adaptor and the slim and premium design allows the TV to complement any RV living space.

### 900-05430 18.5 INCH HD TV & DVD COMBO - 12V/240V

#### Specifications

Resolution: 1366 x 768  
Refresh Rate: 60Hz  
Audio Output: 2 x 3W (4Ω)  
Power Input: 12V (240V Adaptor is Included)  
Average Power Consumption: 1.1 Amps  
Dimensions (with stand): 439mm x 154mm x 305mm  
Dimensions (without stand): 439mm x 52mm x 265mm  
VESA Mount: 100mm x 100mm  
Weight (TV only): 3.5kg  
Packaged Weight: 4.5kg



### 900-05438 23.6 INCH HD TV & DVD COMBO - 12V/240V

#### Specifications

Resolution: 1920 x 1080  
Refresh Rate: 60Hz  
Audio Output: 2 x 3W (4Ω)  
Power Input: 12V (240V Adaptor is Included)  
Average Power Consumption: 1.8 Amps  
Dimensions (with stand): 552mm x 154mm x 375mm  
Dimensions (without stand): 552mm x 52mm x 335mm  
VESA Mount: 100mm x 100mm  
Weight (TV only): 4.3kg  
Packaged Weight: 5.5kg



### 900-05434 21.5 INCH HD TV & DVD COMBO - 12V/240V

#### Specifications

Resolution: 1920 x 1080  
Refresh Rate: 60Hz  
Audio Output: 2 x 3W (4Ω)  
Power Input: 12V (240V Adaptor is Included)  
Average Power Consumption: 1.8 Amps  
Dimensions (with stand): 504mm x 154mm x 343mm  
Dimensions (without stand): 504mm x 52mm x 303mm  
VESA Mount: 100mm x 100mm  
Weight (TV only): 4.0kg  
Packaged Weight: 5.1kg



# SPHERE™ CABLES

## SPHERE RG6 CABLES WITH COMPRESSION FITTINGS

Sphere RG6 Coax Cables are heavy gauge and feature excellent insulation and shielding optimized for high bandwidth, high frequency applications such as Satellite and Digital TV.

Quad Shield - Sphere RG6 cables are quad shielded meaning they have an additional layer of foil and braid shielding. This extra shielding prevents interference to your signal, preserving signal quality; especially over longer cable runs.

Compression Fittings - Sphere RG6 cables come supplied with F-Type and Pal compression fittings already fixed to the cable. This makes using and installing the cables much easier as no crimping or compression tools are required.



### Specifications

1.02CCS 27% conductivity  
4.6 FPE  
Foil+72\*0.16AL+AL  
Foil+48\*0.16AL  
7.6PVC Jacket (WHITE)

**900-05570**

**SPHERE 1.5M RG6 QUAD SHIELD COAX LEAD PAL - PAL**

**900-05572**

**SPHERE 1.5M RG6 QUAD SHIELD COAX LEAD PAL -F-TYPE COMPRESSION FITTING**

**900-05580**

**SPHERE 1.5M RG6 QUAD SHIELD COAX WITH COMPRESSION FITTINGS - F-TYPE**

**900-05582**

**SPHERE 3.0M RG6 QUAD SHIELD COAX WITH COMPRESSION FITTINGS - F-TYPE**

**900-05584**

**SPHERE 6.0M RG6 QUAD SHIELD COAX WITH COMPRESSION FITTINGS - F-TYPE**

**900-05586**

**SPHERE 10M RG6 QUAD SHIELD COAX WITH COMPRESSION FITTINGS - F-TYPE**

## SPHERE HDMI CABLE V2.0 HIGH SPEED WITH ETHERNET

Sphere HDMI V2.0 Cables are extremely high bandwidth capable of transmitting 18Gbps. This makes them perfect for high resolution applications such as Ultra HD 4k TV.

- > Supports Ethernet, 3D, 4K video and Audio Return Channel (ARC)
- > Connects Blu-ray players, Fire TV, Apple TV, PS4, PS3, Xbox one, Xbox 360, computers and other HDMI-enabled devices to TVs, displays, A/V receivers and more
- > Cables allow you to share an Internet connection among multiple devices without the need for a separate Ethernet cable Meets HDMI 1.4
- > Meets the latest HDMI standards (4K Video at 60 Hz, 2160p, 48 bit/px color depth) that supports bandwidth up to 18Gbps and backwards compatible with earlier versions



### Specifications

#### Gauge:

1.5m - 5m : 30AWG  
10m: 28 +26 AWG  
15m: 28+24 AWG

#### Material: CCS

Pins: 19+

**900-05588**

**SPHERE 1.5M HDMI CABLE V2.0 HIGH SPEED WITH ETHERNET**

**900-05590**

**SPHERE 3.0M HDMI CABLE V2.0 HIGH SPEED WITH ETHERNET**

**900-05592**

**SPHERE 5.0M HDMI CABLE V2.0 HIGH SPEED WITH ETHERNET**

**900-05594**

**SPHERE 10M HDMI CABLE V2.0 HIGH SPEED WITH ETHERNET**

**900-05596**

**SPHERE 15M HDMI CABLE V2.0 HIGH SPEED WITH ETHERNET**



## SPHERE™

## SPHERE TV FITTINGS

**900-05552**  
SPHERE TV FITTINGS  
- MECH FEMALE PAL  
TO FTYPE FEMALE



**900-05554**  
SPHERE TV FITTINGS  
- FEMALE FTYPE TO FEMALE  
FTYPE



**900-05556**  
SPHERE TV FITTINGS  
- FEMALE FTYPE TO  
MALE PAL



**900-05558**  
SPHERE TV FITTINGS  
- MALE FTYPE TO  
FEMALE FTYPE 90°



**900-05560**  
SPHERE TV FITTINGS  
- MALE FTYPE TO  
FEMALE PAL



## SPHERE TV SPLITTERS

**900-05562**  
SPHERE TV FITTINGS  
- 2 WAY SPLITTER (DTV)  
FREQUENCY RANGE:  
5-1000HZ



**900-05564**  
SPHERE TV FITTINGS  
- 3 WAY SPLITTER  
FREQUENCY RANGE:  
5-1000HZ



**900-05566**  
SPHERE TV FITTINGS  
- 4 WAY SPLITTER (DTV)  
FREQUENCY RANGE:  
5-1000HZ



**900-05568**  
SPHERE TV FITTINGS  
- ANT/SAT DIPLEXER



**900-05569**  
SPHERE TV FITTINGS  
- MULTI SWITCH 3 IN  
4 OUT



## SPHERE TV HDMI SPLITTER &amp; SWITCH

**900-05598**  
SPHERE HDMI 4 WAY SPLITTER  
& USB DC LEAD

## Features

- > 1 input and 2/4 output (Splitter), 3/5 input and 1 output (Switch)
- > 1080p HDTV Support
- > HDCP Compliant
- > Supports DTS,Dolby 7.1 Channel
- > Plug n Play



**900-05600**  
SPHERE HDMI 5 IN 1OUT SWITCH  
& USB DC LEAD

## Features

- > Multifunctional on switching: intelligent or mechanical
- > IR extender receiver and remote control
- > Supports 2.5Gbps per channel and 1080p resolutions.
- > Adaptive receiver equalization.



900-05906

**LIPPERT 12VOLT TV SLIDE**

The lightweight Lippert TV Lift system is easy-to-install and program, and with smart technology it can shut off the motor in case of obstruction. The Lippert TV Lift is a great way to save on counter space and an impressive way to display your TV.



- > Easy to install with detailed guides and videos available
- > Patented worm rail design efficiently moves TV up and down
- > Easy one-button program; use the same button to program the two stopping points – programming takes less than one minute
- > Lifts TVs weighing up to 90kg
- > Requires less depth than other systems
- > Manual switch and mounting hardware included
- > 10-foot wiring harness allows for flexible installation
- > Perfect for the home as well
- > Can be used for other applications, such as cabinets or access doors

**SPHERE BLUETOOTH OUTDOOR  
SPEAKER & LIGHT**

Ideal for caravans and motorhomes, the Sphere external flush mount Bluetooth speaker & light combination is the perfect product for your RV's outdoor living space.

It features a powerful LED in a selectable choice of bright white or amber light as well as superior sound thanks to its 20 Watts of audio power. Control your soundtrack with Bluetooth and NFC functionality via your preferred compatible smart device.

The unit is weather-proof and UV stabilised to prevent premature discolouration or breakdown. It has a built-in ultrasonic mosquito repellent feature that will not interfere with hearing aid's or cardiac pacemakers and there is space allocated in the base of the unit to conceal an ONEX brand GPS tracker.

**Features**

- > Ready to mount to your caravan or outdoor area
- > Powerful LED white/amber light
- > Mosquito repelling frequency
- > Waterproof
- > NFC and Bluetooth compatible
- > GPS tracking ready
- > UV Resistant
- > 2 Year Warranty

900-08010

**SPHERE BLUETOOTH  
OUTDOOR SPEAKER &  
LIGHT - WHITE**

900-08012

**SPHERE BLUETOOTH  
OUTDOOR SPEAKER &  
LIGHT - BLACK****AMAZON FIRESTICK SMART TV KIT**

900-05450

**AMAZON FIRESTICK SMART TV  
KIT - INCLUDES REMOTE & HDMI  
DONGLE. FIRE TV STICK**

- > Great performance, picture and Dolby Atmos support - Fire TV Stick simplifies your streaming experience with convenient TV controls, for fast and powerful streaming in Full HD, plus immersive audio with Dolby Atmos support.
- > Thousands of apps - Stream for free with SBS On Demand, 10 play, 7plus, YouTube and more. Enjoy your favourites with subscriptions to Netflix, Stan, Disney+ and Prime Video. Plus watch live TV, news and sport. (Subscription may be required)
- > All-new Alexa Voice Remote with TV controls - Press and hold the voice button and easily ask Alexa to find, launch and control content. Control your compatible TV, soundbar and receiver using dedicated power and volume buttons. Quickly access your favourite content with convenient app buttons.
- > Do more with your TV - View live camera feeds, check the weather and stream millions of songs through Amazon Music, Spotify and more. Fire TV is always getting smarter with new Alexa skills and voice functionality.
- > Includes 2 AAA Batteries
- > Requires 240V power

## SPHERE™ AUTOMATED SATELLITE SYSTEM



Moving with the times, the Sphere Automated Satellite System (SASS) is innovative and technologically advanced. It has been designed to locate and lock onto satellites quickly (in particular, the C1/D3 satellites which cover the majority of Australia). It is compatible with Direct Broadcast Satellites (DBS) which broadcast audio, video and data from satellites about 35,406km away! To ensure the best signal is received from DBS, the SASS must have a clear view of the satellite i.e. make sure there are no trees or heavy cloud in the signal pathway. It also has a built in Digital Broadcast Receiver. SASS comprises of two main components: the dish (which houses the positioning mechanism and twin LNBS) and the indoor unit (IDU which is the systems user interface and allows the user to control/access SASS). SASS comes with a pre-drilled mounting base plate, making it easy to install and offers better weight distribution across the RV rooftop.

900-06002

### AUTOMATED SATELLITE SYSTEM

#### Specifications

Power: 12V

Frequency: 10.7GHz (twin LNB)

Closed Height: 200mm

Size of Mounting Base Plate: 700L x 400W (mm)

#### Recommended Clearance (from centre of rotating head):

600mm - surrounding items such as air conditioners or hatches must not be taller than 260mm. If surrounding items are taller than 260mm, more clearance is needed.

450mm - surrounding items must not be taller than 190mm

200mm - surrounding items must not be taller than 70mm

Installed Weight: 19kg (includes cables and IDU), 16kg (dish and base plate only)

#### SASS Tips

1. Ensure the mounting base plate is installed on the flat surface of the RV's rooftop
2. When selecting a location to stay, make sure:
  - a. The dish has a clear line of sight to view as much of the sky as possible
  - b. The dish is at least 1.5m away from other antennas (HF, VHF and radar) that could interfere with the dish
  - c. The dishes exposure to high powered surveillance radar is minimised
3. The mounting base plate is firmly attached to the RV rooftop (Coast recommends using glue and screws)

Spare parts are available if required. Please contact your local Coast Team for more information.



**900-06057****VAST DSD4921RV DUAL TUNER PVR 12V/240V SATELLITE DECODER**

The UEC DSD 4921 RV is already the most trusted "Next Generation" VAST™ Twin Tuner Satellite Receiver. The 4921RV was already the smallest and most versatile Dual Tuner PVR-ready VAST™ receiver. Altech UEC is still the most trusted VAST™ certified manufacturer, with the best sales and support network. The 4921RV is already the most reliable VAST™ receiver ever produced, with integrated protection against overheating, over-voltage and short-circuits. Now with new additional features you'll love, the best did get better. Now, you get extra peace of mind with 36 month Australia-wide warranty.

**Features**

- > VAST™ Certified with over the air software upgrade for future features.
- > Smallest VAST™ Certified Set Top Box on the market, ideal for Caravan and RV enthusiasts.
- > Market leading performance with simple installation wizard and fast channel change.
- > Twin Tuner hardware supporting PVR ready functionality to ensure you never miss your favourite show whilst incorporating future proof Uni-cable LNB technology (single cable).
- > Market leading Technology and Software packed with features to make the setup, viewing and operation as easy and intuitive as possible.
- > Ruggedised design and construction to suit the harsh Australian environment with several built-in features to protect your device when connected to 240V mains, Generators or 12V DC battery installations.
- > Optional Accessories Pack for the DIY home installer or the Caravan/RV enthusiast.
- > Low power consumption for 12V DC installation and Australian MEPS (Minimum Energy Performance Standard) compliant ensuring we are environmentally responsible.
- > Backed by 20 years of VAST™ experience and national aftersales support for real peace of mind.

**900-06204****06204 SATKING DVBS2-980CA VAST SET TOP BOX**

The SatKing DVBS2-980CA is Australia's first VAST & Freeview Plus certified satellite TV receiver, making this unit the most advanced VAST receiver on the market. Fully designed in Australia this top of the range receiver brings a new level of features to the VAST platform.

**Specifications****System**

**CPU:** STiH239  
**Processor:** 650MHz  
**Flash memory:** 16MB (NOR) +128MB (NAND)  
**SDDR:** 512MB DDR2 & DDR3  
**EEPROM:** 32 kbyte  
**Tuner**  
**Standard:** DVBS-EN300421, DVBS2-EN302307  
**Input Frequency:** 950 ~ 2150 MHz  
**Video Decoder**  
**Decoding:** MPEG-2 MP@ML, MP@HL HD, MPEG4 H.264/AVC HD  
**Video Format:** Pal B/G  
**Aspect:** 16:9, 4:3  
**Video resolution:** 576i, 576p, 720p, 1080i, 1080p  
**Standard:** ISO/IEC 13818-3  
**Audio Decoder**  
**Decoding:** MPEG-1 Layer I&II, Dolby AC3, MPEG4-HE-AAC V2  
**Connections**  
**Satellite Input:** 2x F Type Female 75  
**oop Output:** 2x F Type Female 75  
**HDMI:** 1x 1.4B  
**YPbPr:** 3x RCA  
**AV Out:** 3x RCA  
**Digital Audio:** 1x Optical S/PDIF, 1x Coaxial  
**USB:** 2x USB 2.0A Type 500mA Max  
**Ethernet:** 1x RJ-45  
**IR Extension:** 1x 3.5mm Jack  
**DC Input:** 1x 2.1mm Jack  
**Data:** 1x RS232  
 9 Pin Din

**900-06299****SATKING APPROVED 1TB PORTABLE HDD**

Store your recorded shows onto this portable hard drive. Suitable for use with the DVBS2-800CA.

**Specifications**

**Dimensions:** 117L x 77W x 13H (mm)

## SPHERE MOBILE WI-FI ROUTER



The Sphere 4G WiFi Router with GPS product gives you the flexibility of surfing the internet with ease on your travels. By inserting a SIM card, the router provides protected internet access for your family and friends.

With the in-built flash drive USB sharing feature, you will also be able to stream movies, videos, music and other file types over the router WiFi signal without consuming any data. The GPS feature allows you to obtain the location of the caravan at any time! Giving you the comfort and security to locate your caravan or motorhome when necessary.

### Features

- > Surf the Internet with ease on your travels
- > Share secure WiFi access to your mobile data connection
- > Stream USB or hard drive content to your devices without consuming data.
- > GPS location tracking security.

### Specifications

Power consumption = 150mA @12V  
WiFi Range (open air) = +100 meters  
4 \* LAN Ports  
1 \* USB Port

### 900-09100 SPHERE MOBILE WI-FI ROUTER - INT ANTENNA



### 900-09102 SPHERE MOBILE WI-FI ROUTER WITH GPS - INT ANTENNA



### 900-10013 FUSION MARINE STEREO UNIT AM/FM/DAB WITH IPHONE/IPOD/ANDROID/ BLUETOOTH

Introducing the MS-RA70, Fusion's sleekest value-packed marine stereo, designed to deliver a quality on-water entertainment experience by incorporating some of the latest marine technologies. The MS-RA70 is engineered to seamlessly replace any standard DIN sized non-marine stereo without the need to reconfigure dash space. Clever styling gives the installer the option of either mounting the stereo with a conventional flush finish or integrating it flat into a glass helm, ensuring a high-end finish to the installation.



#### Specifications

**Peak Power:** 200W Max. (@ 4 Ω)

**Audio Zones:** 2 on-board amplified zones

**Nameable Zones:** Up to 10 characters per zone

**Line Out:** 1 x L+R per zone (requires amplification)

**Subwoofer Out:** 1 x Sub Out Linked to Zone 1 (requires amplification)

**Auxiliary Inputs:** 1 x Stereo RCA Input (AUX)

**Display:** 128 x 64 monochrome optically bonded LCD

**Fusion-Link Wireless:** A Fusion-Link remote control app is available for compatible Apple and Android devices. Visit the Apple® App Store or Google Play™ to download the free app.

**Bluetooth Wireless Technology:** A2DP Bluetooth audio streaming with AVRCP support (album art is not supported)

**USB:** 1 x USB connector at the rear of the unit, supports 1 amp charging

**Audio Format USB:** MP3

**Water Resistance:** IPx7 water resistant from the front panel when correctly mounted.

### 900-10039 FUSION 6" MARINE BLACK SHALLOW MOUNT SPEAKER 150W



### 900-10040 FUSION 5.25" INTERNAL DUAL CONE SPEAKERS 100W (RV-FR52500EM)

Suitable for internal installations, these speakers have a super shallow mounting depth of only 31.5mm, making it perfect for installation behind RV panels.



### 900-10045 FUSION 6" ENCOUNTER 2 WAY SPEAKER (210W)

Stylish, black speakers with a shallow mounting depth of only 44mm. Sold in pairs, it comes with a convenient template to aid with installation and is backed by a 1yr manufacturer's warranty.



#### Specifications

**Rated Power (Watts):** 40

**Frequency Response:** 35 Hz - 24 kHz

**Impedance:** 4 Ohm

**Sensitivity:** 87 dB

**Cone Material:** Polypropylene

**Tweeter:** PEI

**Mounting Diameter:** 126mm

### 900-10156 FUSION APOLLO 770 MARINE ENTERTAINMENT SYST WITH BUILT IN WI-FI.MS-RA770 (010-01905-00)



### 900-10094 FUSION OPTIONAL REMOTE CONTROL



### 900-10108 FUSION MS-NRX300 FULL FUNCTION WIRED REMOTE T/S 700 SERIES & MS-RA205

The MS-NRX300 NMEA 2000 Certified Wired Remote Control is an out of the box solution for adding localized control of a compatible FUSION marine entertainment system to any RV. The MS-NRX300 features a sleek new innovation: the glass helm flush mounting option. You can now choose either a flush mount for a stunning glass helm finish, or you can easily install with the conventional dash mount finish. Either way, the feature packed MS-NRX300 will give you everything you want from a wired remote and more.



#### Multi-Zone Technology

Install a remote in each independent audio zone, up to four zones depending on your FUSION entertainment system, to create localised volume control, as well as global source control. Now you have even more control in creating a customised audio entertainment experience around your vehicle.

#### IPx7 Waterproof

Perfect for installation inside the camper/RV, the MS-NRX300 is designed and engineered for the outdoor environment.

#### Optically Bonded 2.6" LCD Display

The MS-NRX300 sports a large, high contrast, daylight viewable display making it easy to navigate and stay in control of your audio entertainment experience.

## FURRION AUDIOVISUAL ENTERTAINMENT



Furrion delivers innovative technology engineered, designed and tested to withstand unique performance requirements of mobile applications, including extreme weather climates and road vibrations.

### FURRION LED TELEVISIONS

From the very beginning, Furrion audiovisual products have been design to enhance your RV experience. The LED TV is no exception, developed not only for durability, but with technology that delivers world-class performance and picture quality.



- > 12V TV with built-in DVD player
- > Vibrationsmart - designed and tested for vibration resistance
- > Climatesmart - designed and tested for extreme climates
- > Furrion→ smart link communication
- > Added LED strips for extra brightness and picture quality
- > Front or side access buttons
- > 10-30 Volt surge protection
- > Custom Furrion upgraded speakers and amplifier
- > Static isolator reduces image noise and static caused by 12V power sources

### 900-20105 FURRION 24" HD LED TV DVD COMBO

#### Specifications

Resolution: 1366 x 768  
 Refresh Rate: 60Hz  
 Audio Output: 5W x 2  
 Dimensions without stand: 582 x 368.7 x 52mm  
 Dimensions with stand: 582 x 404 x 183mm  
 Vesa Compatible: 100 x 100

### FURRION 5" SPEAKERS

Our 5" outdoor speaker is made from tough, top-quality materials for high definition audio with a pure, distinct sound outdoors.

#### Specifications

Max Power: 30W  
 Impedance: 4Ω  
 Sensitivity: 88db  
 Frequency Range: 120Hz~20KHz

### 900-20200 FURRION 5" BLACK OUTDOOR SPEAKER

Sold Singularly



## FURRION 5" 2-WAY SPEAKERS

Designed for harsh outdoor environments with IP55 waterproof technology. Furrion's two-way dome tweeter and thermoplastic polymer cone boast a light, strong design that deliver crystal clear sound.

## Specifications

Impedance: 4 @1kHz 1V

Frequency: 120±20% Hz

Output Sound Pressure Level: 82 dB

Characteristic Sensitivity: ±3 dB

Effective Frequency Band: Fo~20kHz

Harmonic Distortion: 5% less than 1W 85~20kHz

Polarity: Left "+", Right "-"

Temperature Range: -20°C to 70°C / -4°F to 148°F

Rated Power: 25W

Max Power: 30W

4"/102mm speaker driver: 30W black PP cone paper woofer

1"/38mm speaker driver: 5W hard dome tweeter speaker with black PET cone

Capacitor: 4.7uF non-polar capacitor

Ingress Protection: IP55

**900-20206**  
**FURRION WHITE 5" 2-WAY**  
**IP55 OUTDOOR MARINE**  
**SPEAKER WITH LED**  
**+ LED RING (AM) FMS5L2A-**  
**PS**

Sold Singalarly



## FURRION 5" SPEAKER ACCESSORIES

Furrion offer black and white mounting options with their full range of 5" outdoor speakers. Additional LED Rings are now available!

Compatible with 900-20200, 900-20202, 900-20204 and 900-20206.

**900-20397**  
**FURRION LED RING FOR 5"**  
**OUTDOOR MARINE SPEAKER**  
**(AM)**



**900-20398**  
**FURRION WHITE SURFACE MOUNT**  
**FOR 5" SPEAKER**



**900-20399**  
**FURRION BLACK SURFACE MOUNT**  
**FOR 5" SPEAKER**



## FURRION INDOOR SPEAKERS

Our 6.5" ceiling speaker is made from top-quality materials—for high definition audio with a pure, distinct sound that's perfect indoors.

## Specifications

Max Power: 30W

Impedance: 4Ω

Sensitivity: 86db

Frequency Range: 60Hz~20KHz

**900-20208**  
**FURRION 6.5" BLACK**  
**CEILING SPEAKER**

Sold Singalarly



**900-20210**  
**FURRION 6.5" WHITE**  
**CEILING SPEAKER**

Sold Singalarly





# FURRION AUDIO ENTERTAINMENT

## 900-20212

### FURRION RECESSED WALL SPEAKER SET OF 2

Fiberglass reinforced cone extends frequency response and minimizes distortion. This controls rigidity and internal damping



#### Specifications

Voice coil electro impedance: 4 @1K Hz 1V

Resonance Frequency: 80±20% Hz

Output sound pressure level: 88 dB

Characteristic sensitivity: ±3 dB

Effective frequency band: Fo~20K Hz

Harmonic distortion: 5% less than 1W 85~10K Hz or more than

Power usage: Left "+", Right"-"

Outputs on product: 25W

## 900-20401

### FURRION DV3300S HEAD UNIT W/ NFC AND BLUETOOTH CONNECTIVITY

Compact but powerful, this entertainment system with a built-in DVD player, is optimized for superior performance. With Bluetooth® connectivity and NFC quick-touch communication, it offers a next-generation multi-room entertainment experience.

Enjoy multi-room music with the 2-zone entertainment system. Connect devices wirelessly with Bluetooth® and NFC quick-touch and enjoy more input options with USB, AUX-in. A built-in CD/DVD player saves space in your RV. Featuring Furrion's Vibrationsmart™ and Climatesmart™ technologies for all your adventures on the road.

- > CD & DVD
- > MP3/WMA/MP4/AVI/AM&FM
- > Bluetooth®/NFC
- > Subwoofer connection
- > USB with charging
- > Control by Furrion ES Control app
- > Vibrationsmart™ & Climatesmart™



## 900-20405

### FURRION DV5700S HEAD UNIT W/ BLUETOOTH 5.0 CONNECTIVITY

This sophisticated system is designed to deliver a personalized experience wherever your travels take you. Featuring a built-in DVD player with exceptional media quality, and a USB port that offers easy access and digital playback of your favourite music from USB storage devices, this stylish system is always ready to come along for the ride.

- > Bluetooth 5.0
- > USB Interface
- > Memory card reader
- > Climatesmart™
- > Auxiliary input
- > Vibrationsmart™
- > Subwoofer out
- > Works with unimote
- > Signalsmart



## 900-20600

### FURRION F-TYPE TV INLET/OUTLET BLACK

- > Snap-in F-type connector
- > Coax connectors ideal for satellite and cable feed
- > Durable UV stabilized polyester material
- > Nickel plated brass connector for improved signal transmission and corrosion resistance
- > Satellite compatible
- > Easy installation
- > Wall mount with screws
- > Weatherproof sealing
- > Designed for outdoor applications



## FURRION PORTABLE BLUETOOTH SPEAKER



The all new FURRION LIT was created for mobile and adventurous living, the portable Bluetooth® speaker is compact, big on sound and features a rugged design so you can take it anywhere.

Designed for mobile and adventurous living, the Furrion LIT portable Bluetooth speaker is compact in size and big on sound. Its unique rugged design is waterproof, shockproof, sand proof, comes with a built-in flashlight and has up to 15 hours of play time. LIT can be mounted in an RV so you can take the party anywhere. The mount is simple to install, acts as a charging station and secures the speakers when you're on the road.

**Features**

- > Playtime Up to 15 hours
- > Torch Light
- > Waterproof IPX7
- > Bluetooth
- > NFC
- > Speaker Phone
- > Micro USB Inputs
- > USB Charging Out

**Specifications**

Rated Power 10W x2 RMS  
 Battery 1800mAh x2  
 Signal To Noise Ratio ≥80dB  
 SOS Light Effect Yes

**900-20700**  
**FURRION PORTABLE**  
**BLUETOOTH SPEAKER**  
**- BLACK**



**900-20702**  
**FURRION PORTABLE**  
**BLUETOOTH SPEAKER**  
**- WHITE**



**900-20750**  
**FURRION WIRELESS**  
**CHARGING DOCK**  
**FOR PORTABLE**  
**BLUETOOTH**  
**SPEAKER**



# SUBURBAN WATER HEATERS

**950-00026**

**SUBURBAN SW6DRA HOT WATER SYSTEM - 20.3L  
CAPACITY - DIRECT SPARK LPG**

**Specifications**

Capacity: 20.3L  
 Max working pressure: 700Kpa  
 Hourly gas consumption: 8.7mj/hour  
 Test point pressure: 2.63Kpa  
 Jet orifice size: 0.84mm  
 Type of heating medium: Universal Gas  
 Recovery: 40L/hr 45°C rise  
 Electrical: For automatic gas ignitor 12V DC  
 Dimensions: 320W x 320H x 500D (mm)



Item No.	Part No.	Description
1	950-02522	Module Board
3	950-02532	Cover, Module Board
12	950-01123	Valve Pressure Relief
15	950-02622	Cover, Thermostat/Hi-Limit
20	950-02539	Bracket, Electrode Mounting
21	950-02538	Electrode
26	950-01244	Burner Assembly with orifice
27	950-01258	Air Shutter Assembly (Main Burner)
28	950-02691	Electric Element with Gasket
29	950-01140	Anode
34	950-02670	Gas Fitting
36	950-02632	Valve, Gas (LP)
37	950-01174	Manifold, Outlet
41	950-02600	Switch Assembly, 12 V.D.C. T-Stat/Hi-Limit
42	950-02612	Switch Assembly, 220 V.A.C. T-Stat/Hi-Limit
45	950-01390	Grommet, Gas Inlet
51	950-02500	Switch, Lamp and Plate Assembly
55	Z950-01380	1/4 Loxit Nut (Manifold to Burner)
56	Z950-01380	1/4 Loxit Nut (Manifold to Valve)
57	950-02540	Electrode Wire (Not Shown)
59	950-02697	Cover, Element
63	950-02542	Plug Break Through

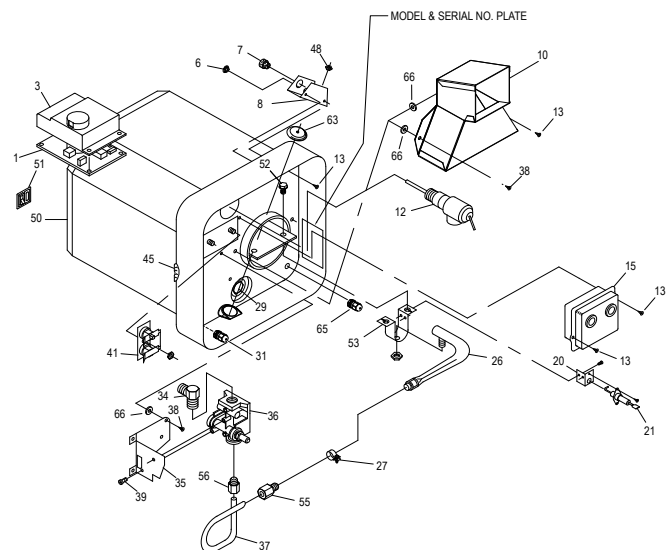

**950-00036****SUBURBAN SW6DERA HOT WATER SYSTEM - 20.3L CAPACITY - 12V/240V/LPG**

Has a 12V ignitor and operates on Universal gas and 240V. User is able to control which operation is sourced by means of an internal switch for gas and an external switch for electricity.

**Specifications**

Capacity: 20.3L

Max working pressure: 700Kpa

Hourly gas consumption: 8.7mj/hour

Test point pressure: 2.63Kpa

Jet orifice size: 0.84mm

Type of heating medium: Universal Gas/240V

Recovery: 40L/hr 45°C rise

**Electrical:**

- For auto gas ignitor: 12V DC

- For models with 240V: 240V - 50HZ AC heating element

- Element rating: 1440W - 6A

Dimensions: 320W x 320H x 500D (mm)

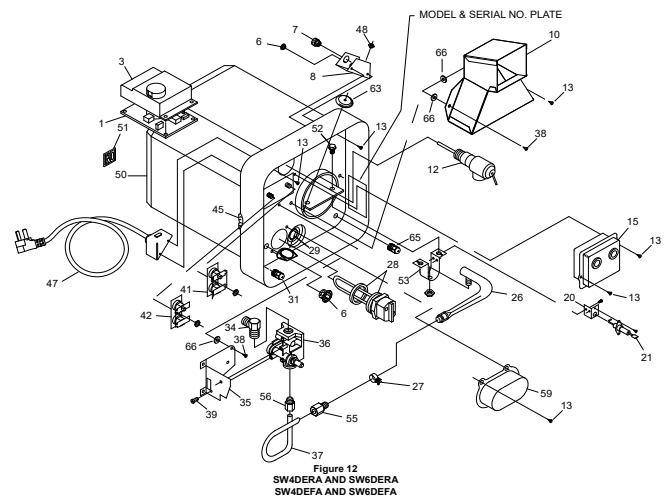

Item No.	Part No.	Description
1	950-02522	Module Board
3	950-02532	Cover, Module Board
12	950-01123	Valve Pressure Relief
15	950-02622	Cover, Thermostat/Hi-Limit
20	950-02539	Bracket, Electrode Mounting
21	950-02538	Electrode
26	950-01244	Burner Assembly with orifice
27	950-01258	Air Shutter Assembly (Main Burner)
28	950-02691	Electric Element with Gasket
29	950-01140	Anode
34	950-02670	Gas Fitting
36	950-02632	Valve, Gas (LP)
37	950-01174	Manifold, Outlet
41	950-02600	Switch Assembly, 12 V.D.C. T-Stat/Hi-Limit
42	950-02612	Switch Assembly, 220 V.A.C. T-Stat/Hi-Limit
45	950-01390	Grommet, Gas Inlet
51	950-02500	Switch, Lamp and Plate Assembly
55	Z950-01380	1/4 Loxit Nut (Manifold to Burner)
56	Z950-01380	1/4 Loxit Nut (Manifold to Valve)
57	950-02540	Electrode Wire (Not Shown)
59	950-02697	Cover, Element
63	950-02542	Plug Break Through

**950-00046**

**SUBURBAN 240V ONLY HWS WITH DOOR (SW5EA)**

Operates on electricity only.

**Specifications**

Capacity: 17.7L

Max working pressure: 700Kpa

Type of heating medium: 240V

Recovery: 21L/hr 45°C rise

**Electrical:**

- For models with 240V heating element: 240V - 50HZ AC

- Element rating: 1440W - 6A

**Dimensions:** 320W x 320H x 450D (mm)



Item No.	Part No.	Description
1	<b>950-01123</b>	Valve, Pressure Relief
2	<b>950-02622</b>	Cover, Thermostat/Hi-Limit
3	<b>950-02624</b>	Gasket, Thermostat Cover
8	<b>950-02691</b>	Electric Element with Gasket
9	<b>950-01140</b>	Anode
14	<b>950-02612</b>	Switch Assembly, 220 V.A.C. T-Stat/Hi Limit
20	<b>Z950-01402</b>	Foam Jacket (2 Required) SW5EA
	<b>Z950-01412</b>	Foam Jacket (2 Required) SW7EA
25	<b>950-02542</b>	Plug, Break Through

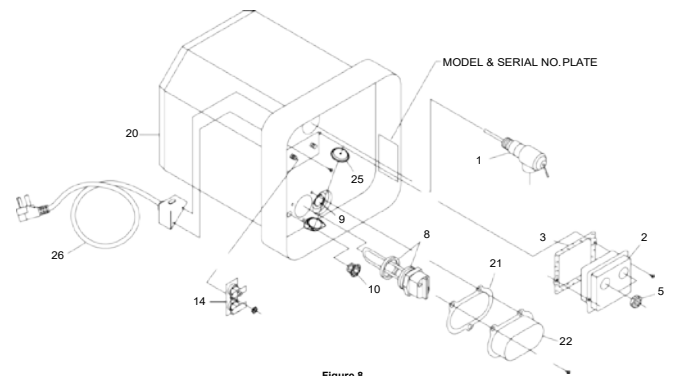

Figure 8

## SUBURBAN WATER HEATERS

**950-00056****SUBURBAN SW4DERA HOT WATER SYSTEM - 15.1L CAPACITY - 12V/240V/LPG**

Has a 12V ignitor and operates on Universal gas and 240V. User is able to control which operation is sourced by means of an internal switch for gas and an external switch for electricity.

**Specifications**

Capacity: 15.1L

Max working pressure: 700Kpa

Hourly gas consumption: 8.7mj/hour

Test point pressure: 2.63Kpa

Jet orifice size: 0.84mm

Type of heating medium: Universal Gas/240V

Recovery: 40L/hr 45°C rise

**Electrical:**

- For auto gas ignitor: 12V DC

- For models with 240V heating element: 240V - 50HZ AC

- Element rating: 1440W - 6A

Dimensions: 320W x 320H x 450D (mm)



Item No.	Part No.	Description
1	<b>950-02522</b>	Module Board
3	<b>950-02532</b>	Cover, Module Board
12	<b>950-01123</b>	Valve Pressure Relief
15	<b>950-02622</b>	Cover, Thermostat/Hi-Limit
20	<b>950-02539</b>	Bracket, Electrode Mounting
21	<b>950-02538</b>	Electrode
26	<b>950-01244</b>	Burner Assembly with orifice
27	<b>950-01258</b>	Air Shutter Assembly (Main Burner)
28	<b>950-02691</b>	Electric Element with Gasket
29	<b>950-01140</b>	Anode
34	<b>950-02670</b>	Gas Fitting
36	<b>950-02632</b>	Valve, Gas (LP)
37	<b>950-01174</b>	Manifold, Outlet
41	<b>950-02600</b>	Switch Assembly, 12 V.D.C. T-Stat/Hi-Limit
42	<b>950-02612</b>	Switch Assembly, 220 V.A.C. T-Stat/Hi-Limit
45	<b>950-01390</b>	Grommet, Gas Inlet
51	<b>950-02500</b>	Switch, Lamp and Plate Assembly
55	<b>Z950-01380</b>	1/4 Loxit Nut (Manifold to Burner)
56	<b>Z950-01380</b>	1/4 Loxit Nut (Manifold to Valve)
57	<b>950-02540</b>	Electrode Wire (Not Shown)
59	<b>950-02697</b>	Cover, Element
63	<b>950-02542</b>	Plug Break Through

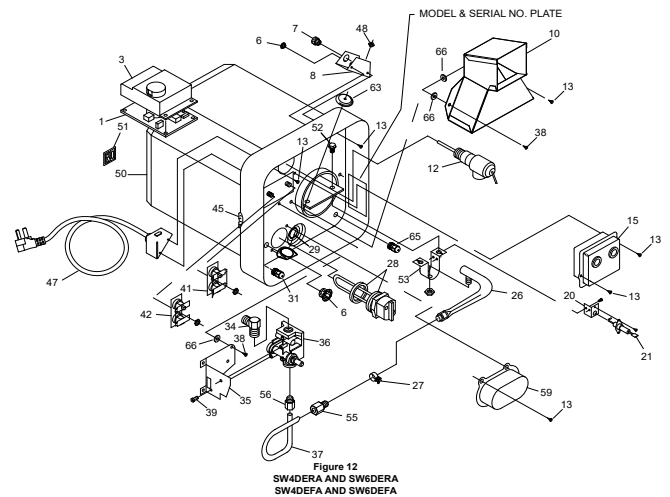

# SUBURBAN HEATER ACCESSORIES

## 950-01140

### SUBURBAN ANODE ROD FOR ALL SUBURBAN HWS

All Suburban HWS' have an anode rod which absorbs all the corrosive action of hot water. It is located on the bottom of the HWS (under the main burner), simply unscrew this to drain the tank of water. If the rod is mostly eaten away, replace it with a new one. The Suburban anode rod fits the 4, 5 and 6 gallon tanks.

#### Did you know?

There are many anode rods on the market. Cheaper imitations may not always be the best fit for a Suburban HWS. Not only are some imitations the incorrect length, you also need to be weary of the thread type (at the head of the rod). The Suburban range of HWS's are made in the USA and they use the NPT style thread for the anode.

Most other parts of the world use a BSP style thread. If a BSP threaded anode rod is fitted into a Suburban HWS it will damage the pitch on the internal thread and cause future leaks. Coast always recommends using a Suburban anode rod in a Suburban HWS.



## 950-01148

### PREMIUM MAGNESIUM ANODE ROD T/S SUBURBAN TANK HWS - SKIN PACK

The Premium Magnesium Anode Rod is made for use in the 4, 5 & 6 Gallon tanks and feature a 304 stainless steel core for increased durability.



## SUBURBAN EXTERIOR DOORS

Suburban exterior doors stand up to the elements and frequent use, with corrosion-resistant steel finished in a tough, high-solids baked enamel for extra chip resistance. Coast to Coast stock the standard doors which are installed without bending flanges or installing corner gussets for easy installation and a superior seal.

## 950-01304

### SUBURBAN POLAR WHITE DOOR

For SW5DEA Water Heater.



## 950-01308

### SUBURBAN NEW STYLE POLAR WHITE DOOR

Suitable for SW6PA, SW6DA, SW6DEA and SW4DEA.



## 950-01312

### SUBURBAN ARCTIC WHITE AUS VERSION RADIUS CORNER DOOR T/S

SW4&6DERA/DRA. 6282AAW



## 950-01314

### SUBURBAN NEW STYLE BLACK DOOR

Suitable for SW6PA, SW6DA, SW6DEA and SW4DEA.

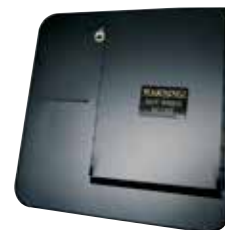

#### Specifications

Dimensions (overall): 381W x 381H (mm)

## 950-01316

### SUBURBAN EBONY BLACK AUS VERSION RADIUS CORNER DOOR T/S

SW4&6DERA/DRA. 6282AEB



**950-01320****SUBURBAN PLASTIC DOOR LATCH CLIP ONLY (WHITE)**

A replacement latch suitable for use on all Suburban HWS Doors.

**950-01324****SUBURBAN PLASTIC DOOR LATCH CLIP ONLY (BLACK)**

For all models.

**950-02500****SUBURBAN SWITCH & PLATE ASSY WHITE**

For SW6DA/DEA.233495/ old 232589

**SUBURBAN HOT WATER HEATER FAQs****Are all Suburban Water Heaters equipped with an Anode Rod? What is its function? When should it be changed?**

YES - all Suburban water heaters feature an anode rod. The anode equalizes aggressive water action, providing cathodic protection for the tank. It is a very important factor in tank life and should only be removed for inspection, draining or replacement. It is removable using a 1-1/16" thin wall socket. Under normal use, the anode rod will deteriorate. Because of this, we recommend it be replaced bi-annually or when consumption or weight loss of the rod is greater than 75%.

Note: Water with high levels of iron &/or sulphate will increase the rate of deterioration. To extend anode life, drain water from tank whenever the RV is not being used. Avoid any extended time of non-use with water in the tank.

**Why does water drip from my water heater's pressure and temperature (P&T) relief valve?**

You may experience water weeping or dripping from your water heater's pressure and temperature (P&T) relief valve when your water heater is operating. Water weeping or dripping does not mean that the P&T valve is defective. As water is heated, it expands. The water system in an RV is a closed system and does not allow for the expansion of heated water. When the pressure of the water system exceeds the relieving point of the P&T valve, the valve will relieve the excess pressure.

**Can I add-on an electric element to a PA/DA Model (GAS ONLY Unit)? What will happen if I use it?**

NO - the use of these aftermarket heating element devices may result in damage to components or the water heater. When aftermarket heating elements are inserted into the anode rod/drain connection, tank life is shortened by accelerating inner tank corrosion. This will be a non-warrantable situation. An upgrade is required to a GAS/ELECTRIC model, for this application.

**What if I operate the water heater without water in the tank?**

Operation without water in the tank on the 12V DC gas portion of the water heater can cause the copolymer insulation jacket to melt and can cause the ECO/Thermostat to trip. Operation without water in the tank on the 230V AC electric portion of the water heater will damage the element.

**There is a bad odour coming from the hot water faucet. How can I correct this?**

Odour from the hot water system is not a service problem and many water supplies contain sufficient amounts of sulphur to produce an odour. The odour is similar to rotten eggs and is often referred to as "sulphur water". Sulphur water is not harmful—only unpleasant to smell. Sulphur water can be caused by a chemical action or by bacteria. The key to eliminating this smell is heavy chlorination of the water system. Add about 177ml of chlorine (common household liquid bleach) to each 10 gallons in the water tank. Then run the heavily chlorinated water throughout the system, opening each faucet one at a time until you smell the chlorine. Let the RV sit a few days and the chlorine should take care of the problem. Then you will need to remove the chlorine by flushing the water system. If you don't have a water filtration system that removes chlorine, you may have a problem getting rid of the chlorine taste. You might consider adding such a system because it allows you to keep water chlorinated and this prevents several problems, including sulphur water. Chlorination also takes care of other types of bacteria and viruses.



# HWS MAINTENANCE ACCESSORIES

## How do I drain my water heater?

Follow the steps below:

1. Turn off electrical power to the water heater either at the switch from the electric element or a breaker.
2. Shut off the gas supply to the water heater.
3. Turn off the pressure pump on the water system.
4. Open both hot and cold water faucets.
5. Remove the anode rod from the tank. (NOTE: TAKE CARE as water may be HOT when drained from the unit).
6. Follow the RV manufacturer's instructions for draining the entire water system.

## 950-02700

### CAMCO SCREW-IN ELEMENT WRENCH 5" FOR SUBURBAN HWS

This zinc-plated element wrench goes where other wrenches can't, allowing you to remove and replace screw-in elements with ease. It works in conjunction with your screwdriver and fits all 5" regular screw-in elements and 1-1/2" nuts.



## 950-02710

### CAMCO T & P UNIVERSAL VALVE REMOVER

Replace temperature and pressure valves faster and more safely. The Valve Remover gives you better access to the water heater housing, reducing injuries. Fits Atwood and Suburban (Mor-Flo) water heaters.



## 950-02720

### CAMCO HWS TANK RINSER

Cleans the sediment that collects at the bottom of your water heater and flushes it out. Note, please use 800-01992 to connect the Tank Rinsers to your garden hose.



## 950-02730

### TUBE SPANNER 1 1/16" X 1 1/2" 250MM OVERALL LENGTH FOR SUBURBAN HWS

This two in one tool will work with Genuine Suburban Anodes and Heat Elements.



## NAUTILUS IW60A ON DEMAND WATER HEATER



Enjoy endless hot water with Suburban's NAUTILUS On Demand RV Water Heater. Say "good-bye" to waiting for water to reheat in a conventional tank. Showers and baths are best enjoyed slowly, so live free from the restraints of limited hot water supplies. Dishes and even the laundry can be done with an infinite supply of hot water whenever and wherever, simultaneously from every fixture.

With no storage tank to heat water, the NAUTILUS On Demand RV Water Heater reduces weight and increases efficiency by only operating when the need for hot water arises. The NAUTILUS On Demand RV Water Heater uses an exclusive 60,000 BTU 2-Stage Modulating Combustion System (MCS) which instantaneously adjusts the LP gas input to provide consistent and endless comfort regardless of your hot water needs.

**950-03000**  
**SUBURBAN'S NAUTILUS ON DEMAND WATER HEATER**

- developed with **INDUSTRY**

**-BEST:**

- > Exclusive 60,000 BTU Two-Stage Self Modulating Combustion System
- > Built-In Freeze Protection
- > Only 16.3kg Installed
- > Two-Year Limited Warranty



**The EXCLUSIVE 2-Stage Modulating Combustion System (MCS)**

**Monitors:**

- > Inlet water temperature
- > Inlet water flow
- > Output water temperature
- > Combustion air fan speed
- > Heat exchanger & burner operation

**SUBURBAN NAUTILUS CONTROL CENTRE**

The On Demand Control Center provides precise temperature control, reliable and consistent comfort from the convenience of your RV.

**950-03500**  
**SUBURBAN NAUTILUS CONTROL CENTRE - WHITE**



**950-03502**  
**SUBURBAN NAUTILUS CONTROL CENTRE - BLACK**



## SUBURBAN NAUTILUS VENTS

A Suburban replacement panel and vent cap are required when replacing Suburban 6, 10, 12, and 16 gallon tank units with the NAUTILUS On Demand RV Water Heater.

**950-03504**  
**SUBURBAN NAUTILUS VENT FOR**  
**0 - 2.5CM (0 - 1 INCHES) WALL**  
**THICKNESS**



**950-03506**  
**SUBURBAN NAUTILUS VENT FOR**  
**2.5 - 5.0 CM (1 - 2 INCHES) WALL**  
**THICKNESS**



**950-03508**  
**SUBURBAN NAUTILUS VENT FOR**  
**5.0 - 7.6 CM (2 - 3 INCHES) WALL**  
**THICKNESS**



## SUBURBAN NAUTILUS ACCESS DOORS

Please note: The images below are shown with the vent cap installed for illustration purposes only. Replacement Panels and Vent caps are sold separately. The Suburban 10 Gallon Replacement panel is used for 10, 12 or 16 gallon capacity unit installations.

**950-03511**  
**SUBURBAN NAUTILUS**  
**ACCESS DOOR**  
**6 GAL (22.7 LITRE)**  
**ARCTIC WHITE**



**950-03512**  
**SUBURBAN NAUTILUS**  
**ACCESS DOOR**  
**6 GAL - BLACK**



**950-03514**  
**SUBURBAN NAUTILUS**  
**ACCESS DOOR**  
**10 GAL - WHITE**



**950-03516**  
**SUBURBAN NAUTILUS**  
**ACCESS DOOR**  
**10 GAL - BLACK**



**950-03518**  
**SUBURBAN NAUTILUS**  
**ACCESS DOOR**  
**6 GAL ATWOOD - WHITE**



**950-03520**  
**SUBURBAN NAUTILUS**  
**ACCESS DOOR**  
**10 GAL ATWOOD - WHITE**



# NAUTILUS ON DEMAND WH

## Installation Configuration Examples

The NAUTILUS On Demand RV Water Heater from Suburban is a truly adaptable platform that offers a variety of installation options to suit your needs. The below configurations examples demonstrate the NAUTILUS system's industry leading versatility.

### Example Configuration 1

The minimum specification install of the Nautilus system required only the system itself and a single vent to suit your vehicles wall thickness. Please note that the unit should be installed as close to wall as possible.



### Example Configuration 2

The maximum specification install of the Nautilus system requires the system itself, the Nautilus Control Centre (available in black or white), a single vent to suit your vehicles wall thickness and a single access door.



# NAUTILUS ON DEMAND WH

PERFORMANCE SPECS	SUBURBAN NAUTILUS
Model	Nautilus IW60A, 5187A
Maximum Mj/Hr	64 (5) burners
Two-Stage Self Modulating Combustion System	YES Stage 1 Operation: 2 Burners Stage 2 Operation: 5 Burners
Fuel Source	Universal LP Gas
Dry Weight	15 kg with vent assembly Optional access panel 2.3 Kg shipping weight
12 VDC = AMPS	2.1 AMPS
Operational Voltage Range	10.2 - 14.5 VDC
MAXIMUM Output Water Temperature	50°C
Output Water Temperature - Factory Setting	50°C
Digital Control Center Temperature Range	35° - 50° (C)
Liters Per Minute (LPM) Required Flow	1.9 LPM
Freeze Protection	Standard
Warranty	2 - Year
Product Dimensions	316.6 mm W x 317.8 mm H x 464.9 mm D (includes inlet & discharge water lines)

Water Temp. Heat Gain From Incoming Water Temp.

Input Water Temp	LPM	Output Water Temp	Gain
10°	5.7	48°	38°
	7.6	38°	28°
	11.4	29°	19°
15°	5.7	48°	33°
	7.6	43°	28°
	11.4	35°	20°
21°	5.7	50°	29°
	7.6	49°	28°
	11.4	39°	18°



# INDEX

12 Volt Compressor	186, 187
12V Awnings	42, 43, 46
12V Fridge Fan	232
12V Gas Detector	198
12V Water Pumps	256 - 261
15 AMP - 10 AMP Adapters	182, 183
15A Leads	179
3 Stage Camper Lifter	51
360 Camera	314
3-Way Fridges	237, 239

## A

AC41 Water Filler	262
Access Doors	202, 203, 204, 206, 207
Accumulator Tanks	276
Adapter Brackets - Fiamma	21, 22
Adapters - Waeco	232
Adco RV Covers	121, 122
Adco Tyre Guards	123
Adhesive	214, 215
Adjustable Ball-Mount Attachment	95
Adjustable Roof Rack	117
Aero Flo Vent Cover	221
Aeroplus Wind Deflector	148
Air Compressor	186, 187
Air Conditioner Gasket	4
Air Conditioners	4, 5, 6, 7
Air Pump	186, 187
Alarmed Trailer Lock	132
Alko Bearing Kits	138
Alko Brakes	137, 138
Alko Corner Steadies	144, 145
Alko Couplings	144
Alko Jockey Wheels	130
Alko Water Tank	265
Aluminium - Truline	52
Aluminium Cladding	54
Aluminium H-Frame	4
Aluminium Step	134, 135
Amp Fibian Surge Protector	183
AmpFibian Adapters	182, 183
Anbi	159
Anderson Plugs	178
Annex Awning	13
Annex Door Roller	27
Annex Matting	29, 30, 31

Anode Rod	333
Antenna Diplexer	319
Antenna Outlets	178
Antennae	304 - 310
Anti-Flap Kits	24
Anti-Theft Kit	148
Anti-Theft Locks	132, 133, 148, 149
Aqua Kem Blue	287, 288
Aqua Kem Green	288, 289
Aqua Kem Sachets	289
Aqua Rinse	288, 289
Aqua Soft Toilet Paper	290
Argent HOBs	242
Argent Sink	277
Ark Bearing Kits	138
Ark Jockey Wheels	132
Ark Tow Balls	70
Assist Handles	160, 161
Astro Annexe	14
Audio Entertainment	320, 324 - 329
Aussie Traveller AFK	25
Aussie Traveller Black	25
Aussie Traveller Rafters	27
Aussie Traveller Spares	25, 27
Australite Four Seasons Hatch	217, 218
Automated Satellites	321
Auxiliary Showers	280, 281
Awning Adapter	23
Awning Cleaner	211
Awning Hardware	37, 43
Awning Hooks	25, 62
Awning Leg Brackets	23
Awning Lights	160, 161
Awning Rafters	21, 27, 39
Awning Rain Guards	22
Awning Repair Tape	26
Awning Stabiliser Kits	25, 26, 62
Awning Support Cradle	44
Awning Tiedowns	25, 26, 62
Awnings	17 - 21, 37 - 47

## B

Bag Awning Poles	28
Ball Level	141
Ball Valves	198
Ball Weight Scales	146

# INDEX

Barbeque	247	Break Away Coil	78
Barbeque Slide Kit	247	Break Away Kits	79
Barbs	258	Break Away Switches	77, 78, 79
Bargman Lights	160	Breaksafe Components	77, 78, 79
Base Plate	147	Breha Hand Pumps	281
Bathroom Accessories	284	Briggs & Stratton Generator	192
Bathroom Cleaner	289	Briggs & Stratton Inverter Generators	192
Bathroom Fixtures	282, 284	Brooms	107
Bathroom Fixtures - WaterMark	282, 283	Bubble Levels	141
Bathroom Module	282	Bucket	61
Batteries	78, 157, 158		
Battery Boxes	158	<b>C</b> Cabin Hooks	206
Battery Isolator	159	Cable Ties	189
Battery Monitors	78, 156	Caframo Fans	190, 191
Bayonet Dust Cap	198	Cafree Altitude Support Pole	39
Bayonet Socket	198	Camco Camping Essentials	61
Bearing Cones	138, 139, 140	Camco Chocks	126
Bearing Seals	138, 139, 140	Camco Cleaning	211
Bearings	138, 139, 140	Camco Curved Leveller	127
Bed End Garages	119	Camco Fridge Bars	107
Bed Frames	49	Camco Grab Handles	119
Bed Saddles	52	Camco Rhinoflex	296
Bezel for Sink	278	Camco Sewer Fittings	296, 297
Bike Rack Ramp	87	Camco Sewer Hose	296, 297
Bike Racks	86, 87, 118	Camco Toilet Drop Ins	298
BiPots	285	Camco Toilet Tissue	290
Birds Eye Camera	314	Camec Door Locks	208
Black Corner Steady	145	Camper Covers	121
Black Nuova Mapa Adjustable Table	113	Camper Lifter	51
Black Shale Fade - Awning	40	Camper Stone Shields	151
Black Streak Remover	211	Camper Trailer Storage	119
Black Sunscreen	34, 35, 36	Camping Essentials	60, 61, 62, 63, 64
Black TV Brackets	315, 316	Camping Furniture	60
Blinds	150	Canopy Easy Lift Arms	50
Bluetooth Speakers	320, 329	Canopy Lift Mechanisms	50
Boaties Cookware	106	Car Audio	324
Bora Fan	191	Caravan Bed Frames	49
Bostik Compounds	214	Caravan Ceramic Coating	212
Brackets for Awning Legs	23	Caravan Covers	121
Brackets for Pole Carriers	109	Caravan De-Flapper Kits	25
Brackets For TVs	315, 316	Caravan Loo Treatment	298
Brake Controllers	77, 78, 79	Caravan Power Adapters	182, 183
Brake Magnet	137	Caravan Reversing Cameras	311 - 314
Brake Shoe Kit	138	Caravan Stone Shield	151
Brass Fittings	195, 196, 197	Caravan Supply Leads	187, 188



# INDEX

Caravan Touch Up Paint	213	Coast Bathroom Accessories	284
Caravanstore Awnings	16	Coast Bearing Seals	139, 140
Caravanstore Centre Rafter	21	Coast Bike Racks	86, 87, 118
Carbon Monoxide Alarm	156	Coast Camping Furniture	60
Carbon Monoxide Alarm	156	Coast Carriers	109
Carefree Altitude Awnings	37, 38	Coast Clean Kit	212
Carefree Awning Hardware	37, 43	Coast Coupling Lock	133
Carefree Awning Maintenance Tips	46	Coast Doors	202, 203, 204
Carefree Awning Spares	45	Coast Fire Pits	64
Carefree Awnings	37 - 44	Coast Hand Pump	282
Carefree Box Awning	46	Coast Jockey Wheels	129
Carefree Curved Rafter	39	Coast Leads	179
Carefree Rafters	39, 43, 44	Coast Lights	160, 161, 162
Carefree Straight Rafter	39	Coast Matting	29, 30
Cargo Bag	82	Coast Picnic Tables	114 - 116
Cargo Bar	71	Coast Pop Top Support	51
Carry Bag	60	Coast Red Ramps	128
Carry Bike Accessories	90, 91	Coast Red Tread and Store	129
Carry Bikes	88 - 92	Coast Roof Rafter	27
Cassette Tank Cleaner	289	Coast Step	133
Cassette Toilets	291, 292	Coast Steps	133, 134
Caulking	215	Coast Sunscreens	32 - 36
CD/DVD Players	327	Coast Tables	114 - 116
Ceramic Coating	212	Coast Tie Downs	62
Ceramic Sink	280	Coast Water Tanks	266
Check Valves	259	Coax Cable Connection	178
Chocks	126, 127, 128	Coaxial Sockets	178
Chromed Faucets	282, 283	Coffee Cup	66, 69
Circuit Breaker Leads	180	Collapsible Bucket	61
Circuit Breakers	180	Collapsible Cupboard	60
Cladding	54	Collapsible Homeware	65
Cleaners	123, 124, 211, 212	Collapsible Storage	65
Cleaners for HWS Tanks	335	Coloured Cups	67 - 69
Cleaning Kit	212	Coloured Plates	68
Cleaning Products	123, 124, 211, 212	Columbia Doors	208
Clip On Mirrors	74	Combination Cookers	240 - 244
Clip Systems	23	Comet Annexe	15
Clips	71	Compact Brake Controller	77
Clipsal Fittings	177, 178	Compact IQ Brake Controller	77
Clothes Airer	61, 106	Concentrated Toilet Drop Ins	298
CMS Fittings	180, 181	Cones for Bearings	138, 139, 140
CO2 Alarm	156	Control Boxes For Windows	209, 210
Coast Aluminium	54	Controllers - Throttle	100
Coast Annex Awning	13	Cookers	241 - 248
Coast Awning Wall Kits	12	Coolmatic Fridges	233, 234

# INDEX

Copper Pigtailed	194
Corner Insert For Windows	209
Corner Steadies	144, 145
Couple-Mate Reversing Hitch	141
Coupling Locks	132, 133, 148, 149
Couplings	142, 144
Covers - Carry Bikes	91
Covers - Circuit Breakers	180
Covers - RV	121
Covers - Vents	221
Crank Up Satellite Spares	307, 308
Cross Bars	117
CRX Fridge Freezers	233, 234
Cupboard	60
Cupboard Rosettes	207
Cups	66 - 69
Curt Spectrum	79
Curt Towing Accessories	79 - 82
Curtain Track	53
Curved Centre Rafter	21, 27, 39

<b>D</b> Decoder	322
Deep Cycle Batteries	157
Deodorisers For Toilets	277, 287 -290, 298
DGN Hinges	209
Dicor Sealant	213
Diesel Fuel Tank	8
Diesel Heaters	7, 8
Digital Signal Finders	310
Dinnerware	68, 69, 104, 105
Directors Chair	60
Dish Drainer	65, 106
Dish Holder	106
D035	142
D035 Lock	132
Dometic Air Conditioners	4, 5, 7
Dometic Dust Reduction System	218
Dometic Fridge Spare Parts	235, 236
Dometic Fridges	234
Dometic Heating System - Air	8
Dometic H-Frame	4
Dometic Rangeshoods	228
Door Catch	207
Door Frames	206, 207, 208
Door Holder	118, 206

Door Locks	208
Door Mosquito Nets	108
Door Roller	27
Door Storage Pockets	120
Doors For Suburban Heaters	333
Double Sided Sailtrack	53
Draught Skirt	11
Drifter Monitor	156
Drink Water Filtration Kit	259
Drink Water Freshener	277
Drink Water Hose	263, 264
Drinkware	66 - 69
Drum Brakes	136, 137, 138
DS- 5 Satellite Spares	307, 309
DT- 8 Mark 3 Antenna	310
Duplex Oven	242
Dust Cap for Bayonets	198
Dustbin	107

<b>E</b> Easy Dry	106
Easy-Tune Signal Finder	310
Eaz Lift Hitches	94 - 97
Eaz Lift Sway Controls	96
Eclipse Awnings	42, 43
EcoSpin Portable Washer	231
Egg Carriers	61
Electrex Electrical Components	188
Electric BBQ	248
Electric Brake Magnet	137
Electric Drum Brakes	136, 137, 138
Electric Steps	135
Electrical Equipment	156 - 192
Electronic Brake Controllers	77, 78, 79
Electronic Throttle Controllers	100
Electus Anderson Plug	178
Electus RCD	182
Elixir Mini Vent	216
End Plug For Windows	209
Endless Breeze Fan	156
Enduromats	31
Explore Levels	127
Extension Leads	179
Exterior Doors for Suburban	333
External Cookers	247
External Showers	280, 281

# INDEX

<b>F</b>	F35 Pro Awnings	17	Filters	259	
	F45 Awnings	17, 18	Filtration Kit	259	
	F65 Replacement Awnings	19, 20, 21	Fire Blanket	110	
	F80	19, 20, 21	Fire Extinguisher	110	
	Falcon Mirrors	74	Fire Extinguisher Holders	110	
	Fan and Light Combo	156	Fire Pit	64	
	Fans	156, 190, 191, 216 - 222	First Aid	110	
	Fantastic Endless Breeze Fan	156	Fix-A-Tap Hose	263	
	Fantastic Vents	218	Flag - Happy Hour	61	
	Faucets	282, 283	Flat Out Hose	263	
	Female Gas Floor Socket	198	Flat Out Storage Reels	108	
	Festoon Globes	165	Flick Mixers	282, 283	
	Fiamma Accumulator Tank	276	Floor Matting	29, 30, 31	
	Fiamma Adapter Brackets	21, 22	Foam Tape	54	
	Fiamma Awnings	17 - 21	Fold Away Antennae	309	
	Fiamma Carry Bikes	88 - 92	Folding Bike Rack	86, 87	
	Fiamma Door Holder	118	Folding Chair	60	
	Fiamma Draught Skirt	11	Folding Ironing Board	107	
	Fiamma Easy Dry	106	Folding Recovery Boards	129	
	Fiamma F80	19, 20, 21	Folding Tables	114 - 116	
	Fiamma Fast Clip	23	Four Seasons Hatch	218	
	Fiamma Ladders	24	Frames For Beds	49	
	Fiamma Levels	126	Freedom Awning	46	
	Fiamma Omni Stop	108	Freeview Decoder	307	
	Fiamma Privacy Rooms	9, 10	Freeview TVs By Telesat	307	
	Fiamma Rafters	21	Fresh Up Sets (Thetford)	294	
	Fiamma Rain Guards	22	Fresh Water Pump	256 - 261	
	Fiamma Rivets	22	Fridge Airator	107	
	Fiamma Royal Blue	18, 19, 20, 21	Fridge Bars	107	
	Fiamma Royal Grey	17 - 21	Fridge Braces	107	
	Fiamma Security Handles	118	Fridge Fans	232	
	Fiamma Side Walls	11	Fridge Sunscreen	36	
	Fiamma Soap Dispenser	108	Fridge Switch	232	
	Fiamma Steps	134	Fridge Vent Sunscreen	36	
	Fiamma Storage Pockets	120	Fridge/Freezers	233 - 239, 249 - 252	
	Fiamma Table Leg Parts	111	Fridges	233 - 239, 249 - 252	
	Fiamma Toilet Tissue	290	Front Sunscreens	32 - 36	
	Fiamma Toilets	285	Fuel Filler	261	
	Fiamma Vents	219, 220	Fuel Storage	8, 276	
	Fiamma Waste Tank	297	Fuel Tanks	8, 276	
	Fiamma Water Fillers	261	Furrion	311, 325 - 328	
	Fiamma Water Tank	266	Furrion Vision S Camera	311	
	Fiamma Winding Handles	22, 23	Fusion Audio Entertainment	324	
	Fiesta Awnings	40, 41, 42			
			<b>G</b>	Galvanised H-Frame	4

# INDEX

Galvanised Shackles	72	Hinge	210
Gas Bottle Slide Kit	199	Hitch Locks	71, 132, 133, 148, 149
Gas Cradles	199	Hitch Step	72
Gas Cylinder Strap	199	Hold Down Strap Kit	25, 26, 62
Gas Cylinders	199	Holman Hose Adapter Set	267
Gas Detectors	199	Hooks for Cabins	206
Gas Fittings	195, 196, 197	Hose - Carriers	109
Gas Floor Socket	198	Hose - Gas	194, 195, 196
Gas Hose	194, 195, 196	Hose - Lido Junior	246
Gas Regulators	193, 194	Hose - Sewer	294, 295, 296, 297
Gas Sealant	193	Hose - Shower	280 - 283
Gas Sealing Tape	193	Hose - Water	263, 264
Gas Struts	48	Hose Adapters	267
Gas Testing Nipple	198	Hose Connector Set	267
Gas Unions and Adapters	195, 196, 197	Hose Storage	109
Gas Water Heaters	329 - 332	Hot Pot Electric BBQ	248
Gasket Kit - Air Conditioner	4	Hot Water Service Flusher	335
Generators	192	Hot Water Services	329 - 332
Globes	165	Hub Drums	136, 137, 138
Glo-X	62, 63	Hush Smoke Alarm	156
Grab Handles	118, 119, 160, 161	HWS Tank Rinser	335
Grey Picnic Table	115, 116	Hydosilex	212, 213
Grey Water Deodoriser	277, 287 -290, 298		
Guard - Tyre	123	<b>I</b> Ibis Air Conditioner	4
Gullwing Hitch Lock	149	In-Line Check Valves	259
Guy Ropes	62	Interconnecting Leads	180
		Interior Ladders	24
<b>H</b> Hand Brake Spares	73	Interior Lights	162, 166, 167
Hand Pumps	281, 282	Interior Speakers	324, 327
Happy Bowl Toilet Liners	300	Inverter Generators	192
Happy Hook Awning Tie	25	Ironing Board	107
Happy Hour Flag	61		
Happy Wanderer Antennae	310	<b>J</b> Jack Pads	125
Happy Wanderer Signal Booster	310	Jack Stands	125, 126
Harrier Air Conditioner	5, 7	Jacks	125, 126
Hatch	216 -223	Japanese Bearings NSK	140
Hayman Reese Brake Controllers	77	Jayco Bag Awning Poles	28
Hayman Reese Hitches	92, 93	Jayco Fan Light	156
HDMI Cable	318	Jensen Spare Parts	217
HDMI Splitter	319	Jerry Can Holders	136
Heavy Duty Coupling Locks	132, 133, 148, 149	Jockey Wheel Clamps	130, 131
Heavy Duty Water Tanks	266	Jockey Wheel Receiver	126
Heavy Duty Wheel Clamp	142	Jockey Wheels	129 - 131
Hex Winder Handle	131	John Guest Plumbing	267- 272
H-frames	4	John Guest Tempering Valve	283

# INDEX

John Guest WaterMark Fittings	270, 271
JRV Tank Monitors	276
Jug	70

## K

Kirra Annex Awning	13
Kit Set - Tent	13
Kitchen Broom	107
Kitchen Sinks	277, 278, 279
Kojack Jack Kit	147
Kombi Hatch	219
Kovix	132

## L

Ladders	24
Lantern Hanger	61
Lap Sealant	213
Laundry Accessories	61, 106, 229, 231
LCI Lippert Brakes	136, 137
LCI Sway Command	85
LED Bulbs	166, 167
LED Picnic Table	115, 116
LED TVs	317, 325
LEDs	160 - 167
Lenses for Lights	160
Levelling Systems	126, 127, 128
Lido Junior Cookers	246
Lift Mechanisms	50
Lift-O-Mat Struts	48
Lighting Tracks	26
Lights	156, 160, 161, 162, 164 - 167, 169 - 170
Link Box For Windows	209, 210
Lipper Slide Outs	55, 56
Lippert Brakes	136, 137
Lithium Batteries	157
Load Indicator	146
Lockable Fuel Filler	261
Lockable Water Fillers	261
Loo Treatment	298
Luxeal Sealant	193
Luggage Rack	117

## M

Maestro	191
Male Bayonet Socket	198
Manchester Tanks	199
Marine Speakers	324, 328
Matting	29, 30, 31
Max De-Flapper Kits	25

MaxxAir Ventilation	221
Melamine Dinnerware	104, 105
Mesh - Stone Shield	152
Metal Grab Handles	205
Microwave Oven	248
Microwave Turntable	248
Mildew Remover	211
Milenco Aero	74
Milenco Doors	208
Milenco Mirrors	74
Milenco Security Pin	132
Milenco Wedges	150
Millard Water Tank	265
Mini AmpFibian	182
Mini Dish Drainer	106
Mini First Aid Kit	110
Mini Vent	216
Minigrill HOBs	244
Mirrors	74, 75, 76
Mobile Wifi Router	323
Modular Water Tank	266, 267
Mold Inserts	52, 53
Mosquito Nets	108
Motorhome Covers	121
Motorhome Reversing Cameras	311 - 314
Mounting Blocks	180
MPPT	186
Mud Flaps - Stone Shield	152
Muller PVC Vent	223
Multi Purpose Floor Matting	29, 30, 31
Multi Switch	319
My Coolman	249, 250

## N

Narva Electrical Fittings	171 - 175
Narva Heavy Duty Connector	187, 188
Narva Lights	163, 164
Narva Plugs and Sockets	184
Nelson Marine Cooker	243
Nelson Marine Cooker	243
Nemesis Wheel Clamp	148
Neta Hose Adapter	267
No Nails Adhesive	214
Non-Slip Matting	29, 30, 31
NSK Japanese Bearings	140
Nuova Mapa Steps	135

# INDEX

Nuova Mapa Table Leg	113
Nuts	134
Nylon Bushes	145

<b>O</b> Odour-B-Gone Toilet Disks	299
Off Road Couplings	142
Off Road Hitch Lock	149
Offside Privacy Screen	36
On Demand Water Heater	336 - 339
Orbit Air	14 - 16
Organiser	60
Outback RV Super Wash	124
Outdoor Furniture	60
Outlets For Waste	279
Ovens	240 - 244
Owners Handbook	110

<b>P</b> Padded Chair	60
Palm	66 - 69
Panorama Door Locks	208
Pedal Box Throttle Controllers	100
Picnic Tables	114 - 116
Pigtails	194
Pipeline Plumbing Fittings	275
Plas-T-Cote	213
Plastic Bag Storage	107
Plastic Bed Saddles	52
Plastic Fuel Cans	276
Plastic Glasses	66 - 69
Plastic Grab Handles	118, 119, 160, 161
Plastic Plumbing Fittings	267 - 275
Plastic Steps	134
Plate Storage	106
Plugs	175 - 182
Plugs - Sinks	279
Plumbers Silicone	214, 215
Plumbing Fittings	267 - 275
Plumbing Fittings - WaterMark	270, 271
POD Adapter	183
Pole Carriers	109
Polysafe Drinkware	66
Pop Top Covers	121
Pop Top De-Flapper Kits	25
Pop Top Insert Bow	50
Pop Top Roof Clamps	51

Pop Top Supports	51
Pop-A-Bag Holder	107
Porch Lights	160, 161, 162
Porta Pottis	286
Portable Fridges	249 - 252
Portable Hard Drive	322
Portable RCD	182
Portable Speakers	328
Portable Washers	231
Portable Waste Tank	292, 297
Pots and Pans	106
Power Adapters	182, 183
Power Cord Storage	109
Power Generators	192
Power Inlets	175 - 177
Power Inverter	192
Power Outlets	175 - 177
Power Points	175 - 182
Powerless Light	62, 63
Premier One Cleaning	123, 124
Privacy Rooms	9, 10
Privacy Sunscreens	32 - 36
Prodigy Brake Controller	77
Protection Pad	71
Protector Shade Stays	210
PurpleLine	147 - 149
Push Button Catch	207
Push Rod	52
PVC Vent	223
PWM	186

<b>Q</b> Qube Porta Pottis	286
Quell Carbon Monoxide Alarm	156
Quick Fit Bike Racks	86, 87

<b>R</b> Radio Antenna	310
Radios	324, 327
Rain Guards	22
Ratchet Straps	199
Recovery Boards	129
Reflectors	168
Regulators - Gas	193, 194
Regulators - Solar	186
Regulators - Water Pressure	259
Reich Mirrors	76

# INDEX

Repair Tape	26	Setec Drifter	156
Replacement Awning Poles	28	Sewer Fittings	294, 295, 296, 297
Replacement Globes	165	Sewer Hose	294, 295, 296, 297
Replacement Vent Lids	216 - 220	Sewer Hose Connections	294, 295, 296, 297
Reverse Cycle Air Conditioners	4, 5, 6, 7	Shackle Spares	143
Reversing Aids	141	Shackles	143
Reversing Cameras	311 - 314	Shade Stays	210
Rhinoflex - Camco	296, 297	Shanks - Eaz Lift	95
Rivets	22	Shanks - Hayman Reese	93
Roll Out Awnings	40, 41, 42	Shoe Rack	60
Rollo Vent 40	220	Shower Hoses	280 - 283
Roof Cladding	54	Shower Kits	280 - 283
Roof Clamps	51	Shower Mixers	280 - 283
Roof Racks	117	Showers	280 - 283
Roof Rafters	21, 27, 39	Shurflo Accumulator Tank	276
Roof Sealant	213	Shurflo Barbs	258
Roof Storage	117, 118	Shurflo Filters	258
Rosettes	207	Shurflo Filtration Kit	259
Rotary Vent	223	Shurflo Pumps	256, 257
Rubber Bezel	279	Shurflo Regulators	259
Rubber Radio Antenna	310	Shurflo Spare Parts	258
Rubbish Bin	107	Side Cladding	54
RV Electronics Fridge Switch	232	Side Sunscreens	32 - 36
RV Plus Power Adapter	183	Side Wall for Fiamma Awnings	11
RV-02 Max Power Adapter	183	Signal Finders	305, 310
<hr/>			
<b>S</b> Sachets - Thetford Aqua Kem	289	Silicone Sealants	214, 215
Safe Towing Tips	98, 99	Simson ISR	215
Sailtrack	53	Single Sided Sailtrack	53
Salad Bowl	70	Sink Plugs	279
Saracen Hitch Locks	148, 149	Sinks	277, 278, 279
Satellite Decoder	322	Sirocco Fan	190
Satellites	321	Sizzler Accessories	247
Satking Satellite Box	322	Sizzler Barbeque	247
Screw-On Level	141	Skymaxx Skylight	222, 223
Scupper Vent	223	Slide Kit - Gas Bottle	199
Sealant	214, 215	Slide Kits - Barbeque	247
Sealing Tape	54	Slide Lock for Windows	210
Seals for Bearings	138, 139, 140	Slide Out Rooms	55, 56
Security Cable	133	Slotted Winder Handle	131
Security Handles	118, 119	Smart TV	320
Sensar HV Antenna	304, 305	Smev Sinks	278
Sensar RVH 3095 Antenna	305	Smoke Alarm	156
Sensor Pro	305	Soap Dispenser	108
Service Doors	202, 203, 204, 206, 207	Sockets	184
		Solar Fridge Fan	232

# INDEX

Solar Panels	185	Sphere Solar Regulators	186
Solar Regulators	186	Sphere TV Brackets	315, 316
Spanner Tube- Suburban	335	Sphere TV Fittings	319
Spanners	141	Sphere Washing Machines	229, 230, 231
Spare Awning Poles	28	Sphere Wifi Router	323
Spare Parts - Carefree	45	Spigot Bracket	27
Spare Parts - Dometic Fridges	235, 236	Splitter	319
Spare Parts - Eaz Lift	96, 97	Spring Bushes	145
Spare Parts - Fiamma Bi-Pots	285	Square Water Fillers	262
Spare Parts - Fiamma Vents	220	Stabiliser - Awning	25, 26, 62
Spare Parts - Fiamma Waste Tank	297	Stabiliser Jacks	126
Spare Parts - Freedom Awning	47	Stabilus Gas Struts	48
Spare Parts - Hand Brake	143	Stack-A-Plate	106
Spare Parts - Mirrors	75	Stainless Steel Sinks	277, 278, 279
Spare Parts - Prodigy	78	Stakka Jacks	125
Spare Parts - Reversing Cameras	312	Step Covers	134
Spare Parts - Shurflo Filtration Kit	259	Steps	133 - 135
Spare Parts - Shurflo Pumps	256 - 261	Stone Shields	151
Spare Parts - Sphere Microwave	248	Storage for Batteries	158
Spare Parts - Sphere Washing Machine	230	Storage for Kitchenware	106
Spare Parts - Stone Shields	152	Storage for Water	265, 266, 267
Spare Parts - Suburban	329 - 332	Straight Centre Rafter	21
Spare Parts - Thetford Cookers	244, 245	Strap Ratchet	199
Spare Parts - Thetford Fridges	239, 240	Striker Plate	207
Spare Parts - Thetford Toilets	293, 294	Strip Caulking	215
Spare Parts - Vents	216 - 220	Suburban Anode Rod	333
Spare Parts - Winegard	306 - 309	Suburban Exterior Doors	333
Spare Parts - Winegard Satellite	307, 308	Suburban Spare Parts	329 - 332
Spare Parts Carefree Altitude Awnings	38	Suburban Water Heater Tips	334
Spares - Outlet Flaps	177	Suburban Water Heaters	329 - 332
Spares - Shackles	143	Sunscreens	32 - 36
Spats	136	Sunscreens - Offside	36
Speakers	320, 324 - 329	Super Wash	124
Sphere Battery	157	Surburban Nautilus	336 - 339
Sphere Cables	318	Surburban Nautilus Access Doors	336
Sphere Ekon TV Arm	316	Surburban Nautilus Vents	336
Sphere Lighting System	169, 170	Surface Mount Accessory Sockets	184
Sphere Lithium Batteries	157	Surge Protector	183
Sphere Microwave	248	SW4DERA Suburban Heater	332
Sphere Rangeshoods	228	SW5EA Suburban Heater	331
Sphere Reversing Cameras	312, 313	SW6DERA Suburban Heater	330
Sphere RVX Fridge Freezers	251, 252	SW6DRA Suburban Heater	329
Sphere S7 TVs	317	Sway Command Kit	85
Sphere Satellite	321	Sway Controls	96
Sphere Smart TV	320	Switch - Fridge	232



# INDEX

Switch Plates	181
<hr/>	
<b>T</b> Table Hinge Kit	116
Table Legs	111 - 113
Tables	112 - 113
Tailgate Protection	71
Tank Freshener	290
Tank Monitors	156
Tanks - Water	265, 266, 267
Tap Mixers	281, 282, 283
Tape Foam	54
Tarp Clips	71
Taste Pure Water Freshener	277
T-Bar Antenna	310
Tear Drop Assist Handle	161
Telesat TVs	307
Tempering Valves	283
Tent - Kirra Annex Awning	13
Tent Kit Set	13
Tent Tidy	60
Testing Nipple	198
The POD	183
Thermal Blind	150
Thetford Additives	287 - 290
Thetford Cleaners	287 - 290
Thetford Cookers	240 - 244
Thetford Fridge Spare Parts	239, 240
Thetford Fridges	237, 239
Thetford Service Doors	206, 207
Thetford Sinks	278
Thetford Toilet Accessories	287 - 290
Thetford Toilet Tissue	290
Thetford Toilets	285, 291, 292
Thread Sealant	193
Throttle Controllers	100
Thru-Van-Wall Connection	310
Tiedowns	25, 26, 62
Tips - Carefree Awnings	46
Tips - Safe Towing	98, 99
Tips - Suburban Water Heaters	334
Tipsy Stix	61
Tire Linc	84
Toilet Bowl Cleaner	289
Toilet Bowl Liners	300
Toilet Brush Holder	284

Toilet Tissue	290
Toilets	285, 286, 291, 292
Touch Up Paint	213
Tow Ball Mount	70
Tow Ball Scales	146
Tow Ball Spanner	141
Tow Balls	70
Tow Load Indicator	146
Tow Secure Break Away Kit	78
Towel Bar	284
Towing Mirrors	74, 75, 76
Towsafe Weight Scales	146
Toylok	119
TPMS	83, 84
Trail-A-Mate	124, 125
Trail-A-Mate Lock	125
Trailer Cop Coupling Lock	132
Trailer Plugs	187, 188
Trailers Bearings - NSK Japanese	140
Trash Can	107
Travelite Sunscreen	32, 33
Tread Grips	150
Treg Pin Lock	141
Trimatic Door Locks	209
Triple Black Shale Fade Awning	42
Triplex Ovens	240 - 244
Trojan Hand Pumps	281
Trolley	60
Truline Aluminium	52
Truma Air Heater	7
Truma Aventa Air Conditioner	5, 6
TST Tabs	277
Tube Spanner - Suburban	335
Turbo 28 Vent	219
Turbo Vent 160	219
TV Antennae	304 - 310
TV Brackets	315, 316
TV Cables	318
TV Fittings Sphere	319
TV Signal Boosters	305, 310
TV Signal Finders	305, 310
TV Slide	320
TVs	317, 325
Twin Jockey Wheels	131
TwinTrack	26

# INDEX

Two-In-One Tool	335	Water Tempering Valve	283
Tyre Guard	123	WaterMark	270, 271, 280, 282, 283
Tyre Inflators	186, 187	Waterproof Lock	132
Tyre Pressure Monitor	83, 84	Weight Distribution Hitches	94 - 97
<hr/>			
<b>U</b> Unimaxx Vent Lid	217	Wheel Chocks	126, 127, 128
Universal Vent Lid	217	Wheel Nut	134
USB	177, 182	Wheel Spats	136
USB Socket	177, 182	Wheels for Jockey Wheels	130
<hr/>			
<b>V</b> Valteera Access Hatch	209	Wifi Router	323
Valterra Hose Mender	259	Wind Deflector	149
Valterra Sewer Hose	294	Winder Handles	22, 23, 131
Valterra Sewer Valves	294, 295	Winding Handles - Awning	22, 23
VarioHeat	7	Window Awnings	39
Vast Box	322	Window Parts	210
Vent 28	219	Winegard Satellite Spare Parts	307, 308
Ventline Spare Parts	217	Winegard Satellite Spares	307, 308
Ventline Vents	216	Winegard Sensor Antennae	304, 305
Vents	216 - 223	Winegard Sensor Pro	305
Video Storage	322	Winegard Spare Parts	306 - 309
Vinyl Repair Glue	26	Winegard Wingman Booster	306
Vision S Furrion Camera	311	Wineglass Table Leg	112
VLP Vinyl Repair	26	Wingman Signal Booster	306
Voyager Brake Controller	77	Wireless Lighting System	169, 170
<hr/>			
<b>W</b> Waeco Fridge Accessories	232	Wiring Loom Assemblies	135, 180
Waeco Fridges	233, 234	WOW Control Boxes	210
Wall Kits	12	WOW Slide Lock	210
Wall Mount Trash Can	107	WOW Winder Handle	210
Wash and Wax	211	<hr/>	
Washing Machines	229, 230, 231	<b>X</b> XF Folding Bike Racks	86, 87
Waste Hose	263, 264	<hr/>	
Waste Kit for Plugs	279	<b>Z</b> Z-Bond No Nails	214
Waste Outlets	279	Z-Bond Plumbers Silicone	214
Waste Tanks	292, 297		
Water Fillers	261, 262		
Water Freshener	277		
Water Heaters	329 - 332		
Water Proofer	211		
Water Tablets	277		
Water Tank - Modular	266, 267		
Water Tank Anode Rod	333		
Water Tank Monitors	156		
Water Tanks	265, 266, 267		

## LIPPERT TIRE LINC

See More on Page 084

**Tire Linc**   
Tire Pressure & Temperature Monitoring System



Is your RV ready for the road? The Tire Linc® (TPMS) by Lippert™ is the easy-to-install, always-on tyre pressure and temperature monitoring system that makes sure you're always ready for the road. Integrated with Lippert's OneControl® app, you can monitor your camper trailer, caravan, motorhome, or towed vehicle's tyre pressure and temperature right from your smartphone – don't mess with additional dashboard interfaces again.



## SKYMAXX & SKYMAXX PLUS



Natural light and fresh air - the basic fundamentals to the richness of our individual lives and our unique living environments. Light and fresh air create within us a variety of moods that often make any surrounding an oasis. While enjoying time with family, neighbours or just simply relaxing, MAXXAIR's new SKYMAXX Series of skylights can add so much function, drama, balance and ventilation to any environment.

See More on Page 222



**Coast to Coast**  
CARAVAN & LEISURE

## COAST TO COAST RV SERVICES

### AUSTRALIA [coastrv.com.au](http://coastrv.com.au)

#### NSW (HEAD OFFICE) - (Trade Clients Only)

3 George Young Street, Auburn NSW 2144  
(PO Box 6287, Silverwater NSW 1811)

Phone › 02 9645 7600

Fax › 02 9645 7688

Email › [salesnsw@coastrv.com.au](mailto:salesnsw@coastrv.com.au)

#### VICTORIA OFFICE (Trade Clients Only)

1 - 3 Burnett St, Somerton VIC 3062

Phone › 03 9930 0500

Fax › 03 9930 0599

Email › [salesvic@coastrv.com.au](mailto:salesvic@coastrv.com.au)

#### QUEENSLAND OFFICE

48 - 56 Meakin Road, Meadowbrook QLD 4131

Phone › 07 3386 7100

Fax › 07 3386 7199

Email › [salesqld@coastrv.com.au](mailto:salesqld@coastrv.com.au)

#### WA OFFICE (Trade Clients Only)

Cnr Baile Rd & Barrel Way, Canning Vale WA 6155  
(1 Barrel Way, Canning Vale WA 6155)

Phone › 08 9484 6000

Fax › 08 9484 6088

Email › [saleswa@coastrv.com.au](mailto:saleswa@coastrv.com.au)

### NEW ZEALAND [coastrv.co.nz](http://coastrv.co.nz)

#### NZ OFFICE (Trade Clients Only)

74 Greenmount Drive, East Tamaki Auckland

Phone › +64 9 274 8700

Fax › +64 9 274 8701

Email › [enquiry@coastrv.co.nz](mailto:enquiry@coastrv.co.nz)

Technical Email › [technical@coastrv.com.au](mailto:technical@coastrv.com.au)

Warranty Email › [warranty@coastrv.com.au](mailto:warranty@coastrv.com.au)

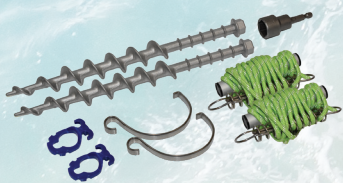

*Your Caravan Store with MORE !!*