

OUTDOOR CATALOGUE 2021

WHEREVER YOU GO

ESSENTIAL GEAR FOR OUTDOOR ADVENTURES

 **DOMETIC** **OUTDOOR**

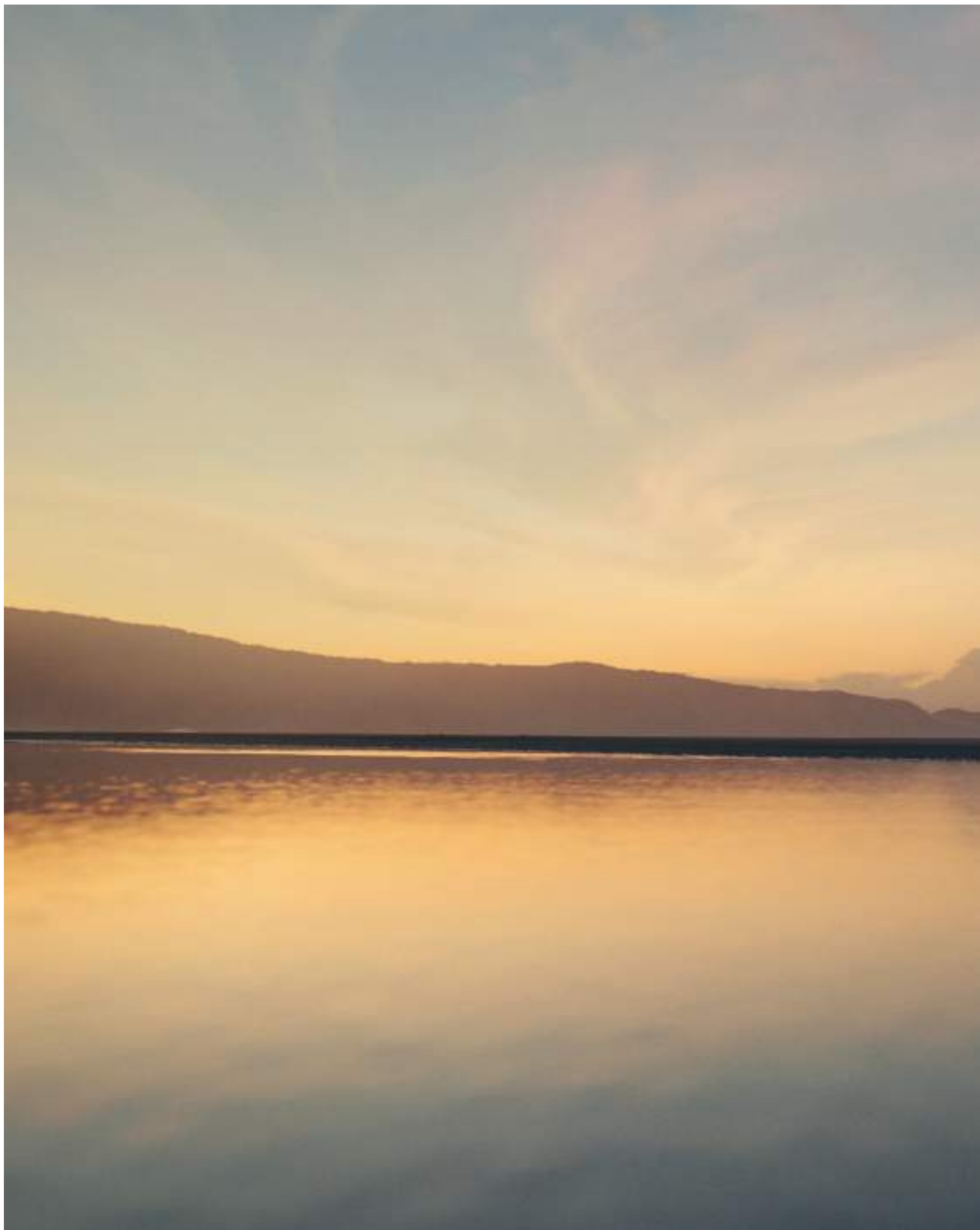

MOBILE LIVING MADE EASY.

WELCOME TO DOMETIC

Millions of people around the world are using Dometic products. They all have one thing in common - the longing for freedom and independence on the move. Our job is to meet their essential needs on the journey. Like cooking, keeping food fresh, taking care of personal hygiene and maintaining a pleasant temperature. We also create solutions to make driving safer and more convenient and innovative electronic devices for smart use of precious battery power. Welcome to our new catalogue! We invite you to go on a journey of discovery. Explore the Dometic world and let us know what we can do for you.





CLIMATE

PAGE 6 - 49



FOOD & BEVERAGE

PAGE 50 - 97



SAFETY & SECURITY

PAGE 98 - 101



POWER & CONTROL

PAGE 102 - 111



HYGIENE & SANITATION

PAGE 112 - 115

CLIMATE

CAMPING TENTS

6 - 31

Inflatable Tents
 Rooftop Tents
 Camping Tent Accessories

INFLATABLE AWNINGS

32 - 49

Caravan & Motorhome Awnings
 Campervan Awnings
 Awning Accessories

FOOD & BEVERAGE

PORTABLE REFRIGERATION

50 - 81

Fridge/Freezers & Coolers
 Iceboxes
 Accessories

OUTDOOR DRINKWARE

82 - 85

Bottles & Tumblers

REFRIGERATORS

86 - 89

COOKING

90 - 97

Outdoor Cooking

SAFETY & SECURITY

SAFETY SOLUTIONS

98 - 101

Gas Detector

POWER & CONTROL

ENERGY & LIGHTING

102 - 111

Generator
 Jump starter
 Chargers
 Inverters
 Batteries
 Solar Panels
 Accessories

HYGIENE & SANITATION

SANITATION

112 - 114

Toilets

CLEANING

115

Additives & Consumables

DOMETIC ON THE WEB

Here's where you can find the complete Dometic range, with detailed information about all products. Plus, interesting facts about our company and download links for all catalogues.

dometic.com

- / INFLATABLE TENTS
- / ROOFTOP TENTS
- / CAMPING TENT ACCESSORIES

CAMPIN



G TENTS

A group of four people are sitting on a sandy beach at sunset. They are gathered around a large, rustic tent structure made of sticks. The background features a large, rocky cliffside and a body of water. The sky is filled with warm, golden light and clouds. The overall scene is peaceful and scenic.



DOMETIC PUTS QUALITY FIRST

When you buy from Dometic, you're buying from a brand with experience. We sell our inflatable tents and rooftop tents to campers the world over. Dometic delivers reliable products that are safe to use and strives for resource efficiency during their entire life cycle.

Whether you're planning a long summer holiday, a weekend adventure or an unforgettable family camping experience, Dometic has a solution to suit. Unbeatable specification and an abundance of living space keep you comfortable wherever you go. Incorporating the highest quality materials, function and design has resulted in the finest range of camping gear for you and your family – giving you the freedom to explore the outdoors.



CAMPING TENTS

Explore more and stay with confidence at your next camping trip with the Dometic camping tents. With these camping tents, you will be able to rest easy as they are specifically designed for the Australian climate. The Weathershield™ material ensures that you are protected from any wind, rain and UV rays you may experience when you're in the outdoors. Once you arrive at your campsite, you will be able to set up the tents with ease thanks to the AirFrame technology, so that you can spend more time appreciating your surroundings.

TENT MATERIALS

THE HIGHEST SPECIFICATION FABRICS DESIGNED TO LAST



WATER-RESISTANT

Tested to 200 L/m² per hour to ensure that you are kept dry.



WEATHERSHIELD™ TC

High quality Weathershield™ technical cotton (TC) material allows the tent to breathe, reducing condensation and helps to regulate the interior temperature on hot days. All the protection with superior comfort.



WEATHERSHIELD™ 68D

Super lightweight Weathershield™ 68D offers the fastest set up and takedown. Highly weather-resistant, this easy to handle polyester offers exceptional value and advanced protection against UV degradation.



An Ultraviolet Protection Factor (UPF) denotes how much solar ultraviolet radiation is reduced when passing through fabric. Dometic tent material allows only 1/50th of ultraviolet rays to pass through, ensuring you're protected.



UPF 50+

TENT KEY FEATURES

INNOVATIVE FEATURES TO ENHANCE YOUR CAMPING EXPERIENCE



CLIMATE CONTROL

High and low level vents as well as gusseted windows create airflow to ventilate your tent. Ventilation helps prevent condensation and improves comfort.



MULTI POINT INFLATION

Each AirPole is made of a strong TPU inflation tube that is zipped into a tough reinforced polyester cover.



SLEEP-TITE DARKENED BEDROOMS

Removable inner tents use dark materials to help block out early sunlight for a good night's sleep.

* Stradbroke 4 & 6 TC AIR only



WIDE BEDROOMS

On average, Dometic bedrooms are one of the widest available, ensuring a comfortable night's sleep.



QUICKPITCH™ GUYING SYSTEM

Heavy-duty straps can be pegged out in seconds. Peg the bottom strap taut and adjust the top buckle to apply tension.

* Stradbroke 4 & 6 TC AIR only



CABLE ENTRY POINTS

For added convenience, all tents have zipped cable entry points for 12V and mains cable access.





DOMETIC AIRFRAME

Quick and secure – our ground breaking innovation
has revolutionised camping

Dometic inflatable tents will transform your camping experience. Our reliable AirFrame system uses multiple inflation and deflation points for the most straightforward, time-saving tent set up and takedown.

Not only is the AirFrame extremely strong, it can flex in the wind too, meaning you'll never break or bend a pole. Each tent comes with a manual hand pump or for maximum convenience, simply plug in the optional Gale 12 V pump to make set up even easier.



Focusing on ease of use and function, AirFrame tents are extremely durable, maintenance-free and strong.



MULTI POINT INFLATION

With ease of use and function in mind, Dometic have pioneered a range of inflatable camping tents. Multi Point Inflation tents are inflated one AirPole at a time via external inflation points, which double as deflation points. AirPoles create a strong structure that can withstand

the elements and greatly reduce set up time. Much like other technologies, Dometic's product development continually look to improve the design and function of AirFrame tents with enhancements made constantly.

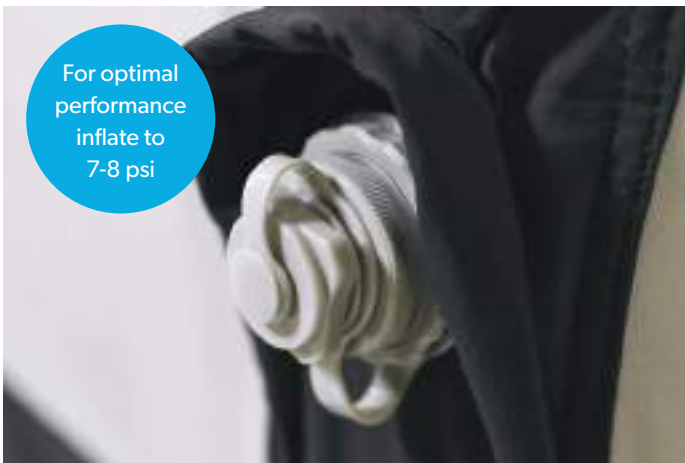

For optimal performance inflate to 7-8 psi



Each AirPole is made of a strong TPU inflation tube that is zipped into a tough reinforced polyester cover. This is then zipped into a heavy-duty polyester sleeve in the tent. The result is an extremely well protected, durable AirFrame which requires no maintenance.



INFLATABLE TENTS

STRADBROKE TC AIR

The ultimate solution to camping without compromise

The Dometic Stradbroke TC AIR inflatable tent provides ultimate versatility on your family and friends camping holiday. The latest AirFrame technology offers incredible strength, great durability and with no poles to lose or break, it's extremely reliable too. You can set up in a matter of seconds with the Quickpitch™ Guying System. Simply peg the bottom strap taut, adjust the buckle and you're ready to kick back and enjoy your camping holiday. Designed with durable,

UV protected and weather-resistant Weathershield™ technical cotton (TC), you will be sheltered from the elements and kept dry. The weather protected entrance makes getting in and out of the tent easier. Get a good night's sleep due to increased airflow via the multi-level ventilation flyscreens and removable inner tent allowing a darkened sleeping space. Whether you are planning a long holiday or an unforgettable weekend experience, Dometic has a tent to suit.



QUICKPITCH™ GUYING SYSTEM

Peg the bottom strap taut and adjust the buckle to apply tension

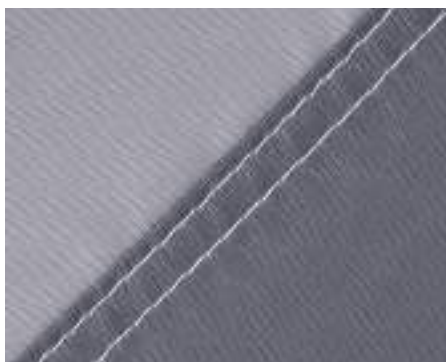

WEATHERSHIELD™ TC MATERIAL

Technical cotton material helps to reduce condensation and regulates the interior temperature



QUALITY FLYSCREENS

Designed for Australian conditions with high quality flyscreens for increased ventilation

STRADBROKE 4 TC AIR

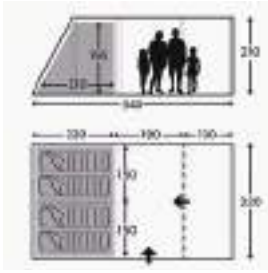

Dimensions W x H x D (mm):
 3200 x 2100 x 5400
 Weight (kg): 33.2
 Ref No. 9600027338
 For specifications see p.26



STRADBROKE 6 TC AIR

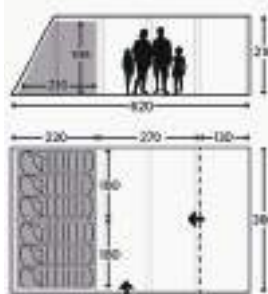

Dimensions W x H x D (mm):
 3800 x 2100 x 6200
 Weight (kg): 41.28
 Ref No. 9600027339
 For specifications see p.26



CLIMATE CONTROL



MULTI POINT INFLATION



DARKENED BEDROOMS



WIDE BEDROOMS



QUICKPITCH™ GUYING SYSTEM



CABLE ENTRY POINTS



WEATHERSHIELD™ TC



AIR FRAME



MULTI POINT INFLATION

Durable AirPoles are inflated individually for the simplest set up and takedown



IMPROVED AIRFLOW

Large oversized windows and gussets to improve airflow and ventilation



DAYDREAM AIR PACKAGE

The perfect camping package

The Dometic Daydream 6 AIR package provides ultimate comfort on your family camping holiday. This inflatable tent will impress with its generous space and how easy it is to set up and pack down. The Dometic Daydream 6 AIR is an inflatable tent designed with AirFrame technology for faster and easier set up without poles. Constructed with durable, lightweight, UV protected and weather-resistant Weathershield™ 68D material, you will be sheltered from the elements. The enclosed front entrance offers a practical area

for creating a large indoor space when the weather is inclement and a large open porch when it's pleasant. Multi-level ventilation points combine with the darkened inner tent to regulate the interior temperature, increase airflow and guarantee a good night's sleep. Each tent package comes as standard with a fitted carpet and footprint. Whether you are planning a long holiday or an unforgettable weekend experience, Dometic has a tent to suit.



MULTI POINT INFLATION

Durable AirPoles are inflated individually for the simplest set up and takedown

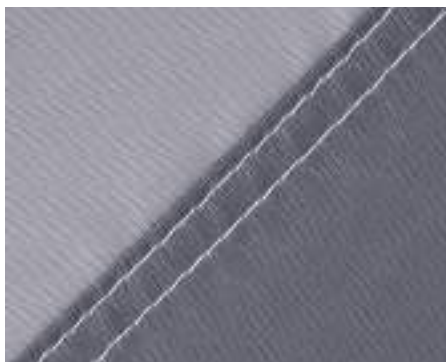

WEATHERSHIELD™ 68D MATERIAL

Super lightweight 68D material is easy to handle, durable and water-resistant



CARPET & FOOTPRINT INCLUDED

The tough footprint protects the underside of the tent and the soft fleece carpet adds comfort to the interior

DAYDREAM 6 AIR PACKAGE

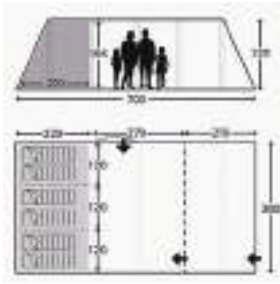

Dimensions W x H x D (mm):
 3800 x 2200 x 7000
 Weight (kg): 35.35
 Ref No. 9600027336
 For specifications see p.26



CLIMATE



CLIMATE CONTROL



MULTI POINT INFLATION



DARKENED BEDROOMS



WIDE BEDROOMS



CABLE ENTRY POINTS



WEATHERSHIELD™ 68D



AIR FRAME



DARKENED BEDROOMS

Inner tents use dark materials to block out sunlight for a good night's sleep



IMPROVED AIRFLOW

Large oversized windows and gussets to improve airflow and ventilation



WIDE BEDROOMS

Generous dimensions provide lots of internal living space, maximising the liveable space of your tent



HAYMAN AIR

The compact solution to camping without compromise

Great for short or long stays, the Dometic Hayman 4 AIR is packed full of features that are sure to please everyone from beginners to camping enthusiasts. Couples, friends and families will love how easy it is to set up. The Dometic Hayman 4 AIR is an inflatable tent designed with AirFrame technology ensuring a simple set up and takedown every time. Made with Weathershield™ 68D material that is durable, lightweight and weather-resistant with UV protection. Large oversized

windows, combined with the darkened inner tent help to regulate the interior temperature, and increase airflow to guarantee a good night's sleep. Open the window gussets and peg out the eyelets to allow privacy and airflow at the same time. A sewn-in groundsheet and variable inner tent come as standard. Whether you are planning a long holiday or an unforgettable weekend experience, Dometic has a tent to suit.



MULTI POINT INFLATION

Durable AirPoles are inflated individually for the simplest set up and takedown



MESH DOOR

Provides ventilation and comfort and has a fly screen to keep insects out



WEATHERSHIELD™ 68D MATERIAL

Super lightweight, extremely durable, advanced UV protection and highly weather-resistant polyester

HAYMAN 4 AIR

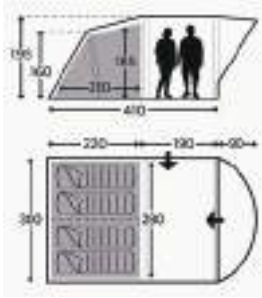

Dimensions W x H x D (mm):
 3000 x 1950 x 4100
 Weight (kg): 18.61
 Ref No. 9600027337
 For specifications see p.26



CLIMATE



CLIMATE CONTROL



MULTI POINT INFLATION



DARKENED BEDROOMS



WIDE BEDROOMS



CABLE ENTRY POINTS



WEATHERSHIELD™ 68D



AIR FRAME



DARKENED BEDROOMS

Inner tents use dark materials to block out sunlight for a good night's sleep



IMPROVED AIRFLOW

Large oversized windows and gussets to improve airflow and ventilation



WIDE BEDROOMS

Generous dimensions provide lots of internal living space, maximising the liveable space of your tent



TAILGATER AIR

Ultimate flexibility on camping adventures

The Dometic Tailgater AIR is an inflatable SUV awning that offers an extended space attached to the back of your vehicle. You can use it for day trips, weekend getaways or camping trips where all you want is a little bit of extra space and a roof over your head. The Tailgater AIR offers enough space to sleep two guests comfortably. There are doors equipped with quality flyscreens on all three sides so you can enter

and exit as you please. It is easy to set up with the inbuilt designed AirPoles that simply need to be pumped using the 2 l pump that comes included. If you want to go for a drive, you can simply disconnect the awning from the vehicle and zip the Tailgater closed. It's easy to carry anywhere and only weighs 12.27 kg.



MULTI POINT INFLATION

Durable AirPoles are inflated individually for the simplest set up and takedown



QUALITY FLYSCREENS

Designed for Australian conditions with high-quality flyscreens for increased ventilation

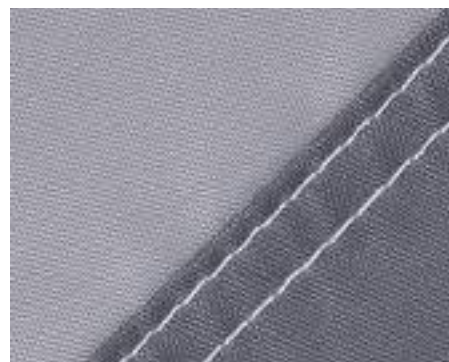

WEATHERSHIELD™ 68D MATERIAL

Super lightweight 68D polyester is easy to handle, durable and water-resistant

TAILGATER AIR

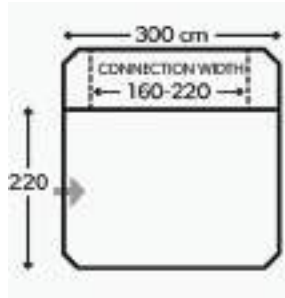

Dimensions W x H x D (mm):
 3000 x 2150 x 2200
 Weight (kg): 12.27
 Ref No. 9600027352
 For specifications see p.26



CLIMATE



CLIMATE CONTROL



MULTI POINT INFLATION



WEATHERSHIELD™ 68D



AIR FRAME



WET WEATHER ENTRANCE

Sheltered access to the awning preventing rain running in when you unzip the door



ADJUSTABLE AWNING TUNNEL

Adjust the height and width of the connecting tunnel. Webbing straps take up material slack to ensure secure fitting



ROOFTOP TENTS

A peaceful night's sleep under the stars

Wake up to a new view every day or choose to stay longer in your dream location. With Dometic rooftop tents you'll feel at home in the outdoors. Our first rooftop tents range is suited for any 4WD and available in both a manual or electric option. Constructed from high-quality durable materials they can be set up in a matter of minutes.

A peaceful night's sleep is guaranteed with the 5 cm thick, high-density foam mattress which is big enough to comfortably fit two people. Entering the tents is easy thanks to the lightweight, telescopic aluminium ladder.



LIGHTWEIGHT

Lightweight aluminium frame and easy to set up



EASY ACCESS

Access the tent with the lightweight telescopic aluminium ladder



IMPROVED AIRFLOW

Designed to suit Australian conditions with adjustable windows and flyscreen

TRT120E

Rooftop 4WD tent, 12 V

- 5 cm high-density foam mattress big enough to sleep two
- Can be set up and packed down in a matter of minutes
- Integrated fly screen to allow airflow through the tent and keep insects out
- Lightweight telescopic aluminium ladder
- Heavy-duty PVC tent cover
- Water-resistant and UPF 50+ two-layer fabric
- Tent frame is made from lightweight aluminium alloy

Dimensions W x H x D (mm): 1200 x 1100 x 2000

Packed size W x H x D (mm): 1400 x 300 x 2250

Weight (kg): 52.4 inc. ladder

Ref No. 9600027166

For specifications see p.27



QUICK AND EASY SET UP



CLIMATE CONTROL



12 V

TRT140M

Rooftop 4WD tent, manual

- Water-resistant and UPF 50+ two-layer fabric
- Can be set up and packed down in a matter of minutes
- Heavy-duty PVC tent cover
- Integrated fly screen to allow airflow through the tent and keep insects out
- Lightweight telescopic aluminium ladder
- Tent frame is made from lightweight aluminium alloy

Dimensions W x H x D (mm): 1400 x 1200 x 2000

Packed size W x H x D (mm): 1620 x 300 x 2250

Weight (kg): 50.6 inc. ladder

Ref No. 9600027165

For specifications see p.27



QUICK AND EASY SET UP



CLIMATE CONTROL

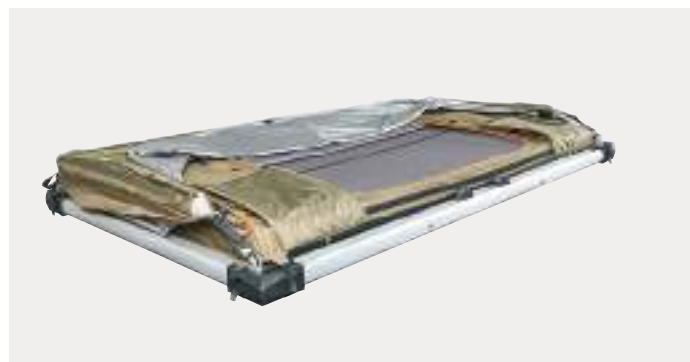

COMPACT

Can be set up and packed down in a matter of minutes



PROTECTION

Tent cover is manufactured from durable water-resistant PVC



ROOFTOP TENT AWNINGS

Add living space to enhance your rooftop tent

Extend your campsite beyond your rooftop tent with a Dometic rooftop tent awning. It takes just a matter of minutes to set up and, when you're ready to move on, it folds down to a compact size for easy storage and transportation. Built for the harshest conditions, rooftop

tent awnings feature durable, water-resistant 210D Oxford ripstop fabric and has a UV resistance rating of UPF 50+. The telescopic aluminium poles are easy to set up and strong enough to withstand harsh outdoor environments.



COMPACT

Folds down to a compact size for storage and transport



EASY ACCESS

Set up in a matter of minutes

TCA100

Classic rooftop tent awning

See more of the great outdoors with the Dometic TCA100 rooftop tent awning. The TCA100 is easy to set up with a Dometic rooftop tent, taking just a matter of minutes. Its durable water-resistant and UV-resistant material ensures you're well protected.

- Suitable for use with Dometic rooftop tents
- Compact for easy storage and transport
- Can be set up in a matter of minutes
- Water-resistant and UPF 50+ material
- Lightweight at only 2.5 kg
- Strong adjustable aluminium poles

Dimensions W x H x D (mm): 3000 x 3000 x 2000

Weight (kg): 2.5

Ref No. 9600027167



**QUICK AND
EASY SET UP**

TMA100

Multifunctional rooftop tent awning

See more of the great outdoors with the Dometic TMA100 multifunctional 4WD awning, the perfect partner for your Dometic rooftop tent. Offering true flexibility at the campsite, the TMA100 can be set up as either an awning or a privacy room in a matter of minutes. Its durable, water-resistant and UV-resistant construction ensures you're well protected.

- Can be set up in a matter of minutes
- Functions as both an awning and privacy room
- Lightweight at only 4.6 kg
- Strong adjustable aluminium poles
- Water-resistant and UPF 50+ material
- Suitable for use with Dometic rooftop tents

Dimensions W x H x D (mm): 2000 x 3000 x 2950

Weight (kg): 4.6

Ref No. 9600027168



**QUICK AND
EASY SET UP**

**QUICK SETUP**

Adjustable pole made from strong yet lightweight aluminium



**UV-RESISTANT FABRIC**

UPF 50+ protects against harmful UV rays and sun

CLIMATE
CAMPING TENTS

SPECIFICATIONS					
INFLATABLE TENTS	HAYMAN 4 AIR	DAYDREAM 6 AIR PACKAGE	STRADBROKE 4 TC AIR	STRADBROKE 6 TC AIR	TAILGATER AIR
Ref No.	9600027337	9600027336	9600027338	9600027339	9600027352
Dimensions W x H x D (mm)	3000 x 1950 x 4100	3800 x 2200 x 7000	3200 x 2100 x 5400	3800 x 2100 x 6200	3000 x 2150 x 2200
Weight (kg)	18.61	35.35	33.2	41.28	12.27
Fabric type	Weathershield™ 68D	Weathershield™ 68D	Weathershield™ TC	Weathershield™ TC	Weathershield™ 68D
Number of Persons	4	6	4	6	–
Frame type	Inflatable	Inflatable	Inflatable	Inflatable	Inflatable
Key features					
Gussets	•	•	•	•	–
Multi Point Inflation	•	•	•	•	•
Darkened bedrooms	•	•	•	•	–
Wide bedrooms	•	•	•	•	–
QuickPitch™ guying system	–	–	•	•	–
Cable entry point	•	•	•	•	–
Scope of delivery					
Heavy-duty carry bag	Wheeled	Wheeled	Wheeled	Wheeled	•
Hand pump	•	•	•	•	•
Pegs	•	•	•	•	•
Canopy groundsheet	–	•	•	•	Removable
Optional extras					
Carpet	•	Included	•	•	–
Footprint	•	Included	•	•	•



SPECIFICATIONS	 TRT120E	 TRT140M
ROOFTOP TENTS		
Ref No.	9600027166	9600027165
Dimensions W x H x D (mm)	1200 x 1100 x 2000	1400 x 1200 x 2000
Packed size W x H x D (mm)	1400 x 300 x 2250	1620 x 300 x 2250
Weight (kg) inc. ladder	52.4	50.6
Frame type	Aluminium alloy	Aluminium alloy
Key features		
Manual	-	•
12 Volt	•	-
Scope of delivery		
Telescopic aluminium ladder	•	•
Wireless remote control	• (2)	-
PVC tent cover	•	•
High-density foam mattress	•	•
Maintenance kit	•	•



ADDED COMFORT



CARPETS

The durable fleece carpet adds comfort to your tent's interior space. A soft touch will create a homely feel, while the tough material will keep your tent groundsheet protected on the inside and make cleaning easier at the end of your trip.

Description	Ref No.
Hayman 4 AIR tent carpet	9600027340
Stradbroke 4 TC AIR tent carpet	9600027341
Stradbroke 6 TC AIR tent carpet	9600027342



FOOTPRINTS

The tailored, non-breathable Dometic Footprint sits beneath the groundsheet, protecting the tent's underside, and help reduce condensation. Pitch your tent anywhere and rest assured that the bottom of the tent won't get damaged.

Description	Ref No.
Hayman 4 AIR tent footprint	9600027343
Stradbroke 4 TC AIR tent footprint	9600027344
Stradbroke 6 TC AIR tent footprint	9600027345
Tailgater AIR awning footprint	9600027356



PITCHING & REPAIRING



GALE 12 V PUMP

Electric pump

- Powerful inflation
- Automatic cut-off
- 6 fitting nozzles

Ref No. 9600027346



REPAIR TAPE

Repair product

- Self adhesive
- Transparent finish
- Flexible

REPAIR TAPE 50 CM

Ref No. 9120000440

REPAIR TAPE 30 M

Ref No. 9120000441



REPAIR SOLUTION

Repair product

- Fixes holes & rips
- Used with Dometic repair tape
- Flexible

Ref No. 9120000442



SEAM SEALANT

Repair product

- Colourless
- Applicator nozzle
- Flexible

Ref No. 9120000443

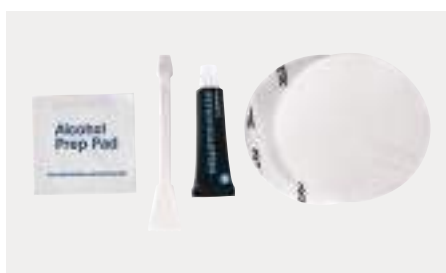

INFLATABLE REPAIR KIT

Repair product

- Self adhesive
- High tensile strength
- Flexible

Ref No. 9120000444



TENT & AWNING REPAIR KIT

Repair product

- Self adhesive
- High tensile strength
- Repair tape

Ref No. 9120000445





CAMPING FURNITURE

Our camping furniture allows you to make the most of your time away with friends and family. Sturdy chairs and tables, with adjustable legs for use on uneven ground, allow you to comfortably sit and enjoy

meals outside your tent or under the awning. Designed for quick and easy set up, create a space where you can eat and relax together – because it's for moments like these that you decided to go camping.



ELEMENT TABLE LARGE

Camping table

- Water-resistant resin tabletop
- Lightweight aluminium frame
- Built to support a loading capacity of 30 kg
- Adjustable legs allow the table to be levelled on uneven ground
- Easy to fold up and store away

Dimensions W x H x D (mm): 1150 x 710 x 700

Adjustable Height Range (mm): 550 - 710

Weight (kg): 7.1

Maximum Load Capacity (kg): 30

Ref No. 9600027373



ZERO CONCRETE TABLE MEDIUM

Camping table

- Easy to fold and stow away
- Fibreglass composite concrete effect top
- Built to support a loading capacity of 30 kg
- Lightweight aluminium frame
- Adjustable legs allow the table to be levelled on uneven ground

Dimensions W x H x D (mm): 900 x 720 x 600

Adjustable Height Range (mm): 590 - 720

Weight (kg): 4.65

Maximum Load Capacity (kg): 30

Ref No. 9600027374

**LOUNGE FIRENZE**

Reclining camping chair

- Powder-coated lightweight aluminium frame that folds up easily for storage and travel
- Padded 600D polyester fabric
- 7 position adjustable reclining backrest
- Bungee cord suspension
- Solid contoured armrests
- Adjustable head cushion

Dimensions W x H x D (mm):
630 x 1210 x 850

Packed Size W x H x D (mm):
1100 x 90 x 650

Weight (kg): 5.1

Maximum Load Capacity
(kg): 120

Ref No. 9600027369

**SERENE FIRENZE
RELAXER**

Reclining camping chair

- Powder-coated steel frame that folds up easily for storage and travel
- Padded 600D polyester fabric
- Variable adjustable recline system
- Bungee cord suspension on the seat base
- Solid contoured armrests
- Adjustable head cushion

Dimensions W x H x D (mm):
640 x 1110 x 750

Packed Size W x H x D (mm):
665 x 130 x 910

Weight (kg): 7.68

Maximum Load Capacity
(kg): 120

Ref No. 9600027370

**FORTE 180**

Camping chair

- Extra strong oversized steel frame
- Durable and padded 2400D polyester seat
- Folds up easily for storage and travel
- Rigid armrests
- Includes fold-out side table
- Powder-coated steel construction

Dimensions W x H x D (mm):
910 x 880 x 530

Packed Size W x H x D (mm):
910 x 700 x 160

Weight (kg): 8.3

Maximum Load Capacity
(kg): 180

Ref No. 9600027371

**GUV'NOR ARMCHAIR**

Camping chair

- Strong oversized aluminium frame
- 600D polyester fabric
- Rigid armrests
- Storage pocket for carry bag creates cushioned headrest
- Folds to a compact size into carry bag for easy transport and storage

Dimensions W x H x D (mm):
640 x 1070 x 580

Packed Size W x H x D (mm):
250 x 180 x 900

Weight (kg): 4.78

Maximum Load Capacity
(kg): 120

Ref No. 9600027372

**DREAM XL STRETCHER**

Camping bed

- Durable 600D polyester
- Easy to set up
- Integrated soft-touch pillow
- Extra-wide for extra comfort
- Oversized strong steel frame
- Safety catches ensure that the bed stays open
- Comes with convenient carry bag

Dimensions W x H x D (mm): 2050 x 510 x 785

Weight (kg): 9.56

Maximum Load Capacity (kg): 120

Ref No. 9600027375

// CARAVAN & MOTORHOME AWNINGS

// CAMPERVAN AWNINGS

// AWNING ACCESSORIES

INFLATABLE



AWNINGS



EXPERT ADVICE FROM AWNING PIONEERS

CHOOSE THE BEST INFLATABLE AWNING FOR YOU AND YOUR VEHICLE

It's important to know the height of the attachment point on your vehicle from the ground to determine which height of awning will best suit your vehicle. For static awnings, this refers to the height from the ground to the awning rail which the awning will be connected to.

For driveaway awnings this could also refer to your vehicle's roof, depending on your preferred fitment method. We offer driveaway and static awnings designed to fit vehicles with heights of 2200 mm up to 3000 mm.



STATIC AWNINGS

For tourers wanting an awning designed for static use, our best-selling static awnings are easy to set up and takedown, providing fantastic fitting to the vehicle side and first class accommodation. Utilising the unique AirFrame system, which links individual AirPoles together, Dometic static awnings can be conveniently inflated from a single point. Twin beading comes as standard (4 mm and 6 mm) and can either be fed through the awning rail attached to your vehicle or threaded through the front channel of a cassette awning.



DRIVE-AWAY AWNINGS

Driveaway awnings offer the ultimate in touring convenience. Quick to set up and completely free-standing, simply detach your driveaway awning and leave it to reserve your pitch whilst you explore the local area in your vehicle.

AWNING KEY FEATURES

INNOVATIVE FEATURES TO ENHANCE YOUR TOURING EXPERIENCE



AIRFRAME™

Focusing on ease of use and function, AirFrame awnings are extremely durable, maintenance-free and strong.



SINGLE INFLATION POINT

Conveniently inflate the entire AirFrame from just one external inflation point.



DUAL-PITCH™ ROOF SYSTEM

Effectively deflect wind and shed rain water efficiently to prevent puddling on the roof and enhance performance.



QUICKPITCH™ GUYING SYSTEM

Heavy-duty straps can be pegged out in seconds. Peg the bottom strap taut and adjust the top buckle to apply tension.



LIMPET™ READY

Pre-punched holes ready to attach the rear wall of the awning to the vehicle using patented Limpet™ Fix technology.



CLIMATE CONTROL

High and low level vents create airflow to ventilate your awning. Ventilation helps prevent condensation and improves comfort.

AWNING MATERIALS

HIGH QUALITY FABRICS TESTED FOR DURABILITY



WEATHERSHIELD™ PRO

The iconic Dometic fabric used extensively throughout the awning range has proven quality in diverse environments. With the look and feel of a traditional fabric, but weighing far less, Weathershield™ Pro continues to be the definitive choice for tourers the world over.



WATER-RESISTANT

Tested to 200L/m² per hour to ensure that you are kept dry.

An Ultraviolet Protection Factor (UPF) denotes how much solar ultraviolet radiation is reduced when passing through fabric. Dometic tent material allows only 1/50th of ultraviolet rays to pass through, ensuring you're protected.



UPF 50+



DOMETIC AIRFRAME

QUICK AND SECURE – OUR GROUNDBREAKING INNOVATION HAS REVOLUTIONISED TOURING

The iconic Rally AIR Pro benefits from years of continuous design improvements and is packed full of the latest awning innovations to enhance your touring experience. Its Weathershield™ Pro material, large windows and additional ventilation create a comfortable living space wherever you pitch-up. Not forgetting Dometic’s unique Single

Point Inflation system and QuickPitch™ webbing straps which ensure a fast and easy set up every time. Ideal for weekend breaks and longer holidays, this versatile awning can be tailored to your needs with mesh panel sets, storm straps and many more accessories.

AIRFRAME PRESSURE IN RESPONSE TO DIFFERING AIR TEMPERATURES

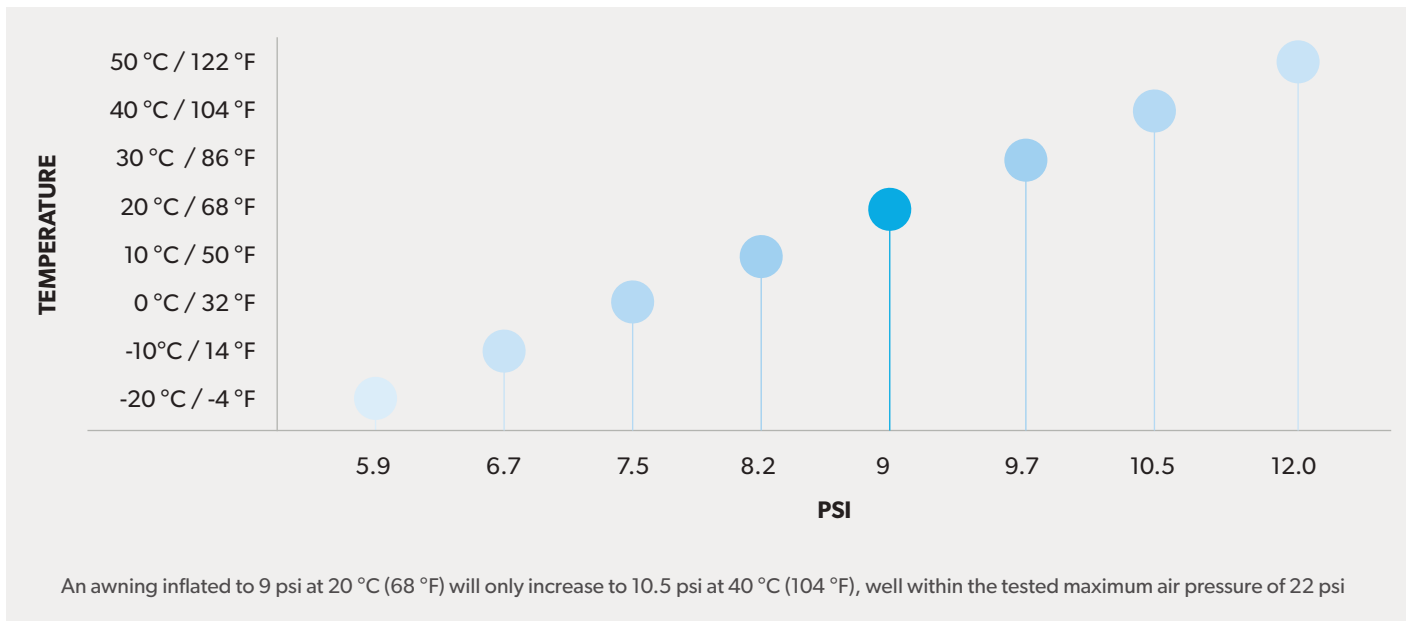

SINGLE POINT INFLATION



Individual AirPoles are linked together allowing the entire awning to be inflated from a single external inflation point. The entire AirFrame is easily deflated through quick release deflation valves at the base of each leg; as each AirPole is connected there is no need to deflate each AirPole individually. So, as well as being the easiest awnings to set up, the user-friendly Dometic awnings are also the easiest to take down.



Deflation valve



For optimal performance inflate to 9 psi

Inflation valve

AIRFRAME CONSTRUCTION

The AirFrame is incredibly durable, each AirPole is made of a strong TPU inflation tube zipped into a reinforced laminated oxford polyester/PE cover, which is then zipped into a heavy-duty polyester sleeve in the awning. Tested up to 22 psi, the AirFrame system best functions when inflated to 9 psi.



RELIABLE TECHNOLOGY

Dometic AirPoles are well protected and require no maintenance. Inflatable awnings are considerably lighter, and with no poles to snap, the AirFrame is also far more durable than conventional poles. Suitable for both hot and cold climates, the AirFrame can even handle extreme changes in temperature.



INFLATABLE CARAVAN & MOTORHOME AWNINGS

RALLY AIR PRO

Transform your holiday

The Dometic Rally AIR Pro is an inflatable awning that offers an extended space attached to your caravan or motorhome. You can use it for weekend getaways or longer trips where all you want is a little bit of extra space and a roof over your head. The patented AirFrame technology in Dometic inflatable awnings and camping tents will transform your holiday. Conventional steel and fibreglass

poles are replaced with interlinked inflatable AirPoles, enabling you to easily inflate and deflate the awning in no time at all. It also comes standard with a draught skirt, peg pack, 2.2 l pump and a carry bag. Not forgetting Dometic's unique Single Point Inflation system and QuickPitch™ webbing straps which ensure a fast and easy set up every time. Ideal for weekend breaks and longer holidays.



QUICKPITCH™ GUYING SYSTEM

Set up in seconds. Peg the bottom strap taut and adjust the buckle to apply tension



SINGLE POINT INFLATION

Single Point Inflation awnings inflate from just one external inflation point



INTERNAL RETURN

Undo velcro and fold out rear bumper pads to create a tight seal to the motorhome side. Designed for use when attaching to a cassette awning

RALLY AIR PRO 260 XL

- Inflatable static awning for caravans or motorhomes
- Single Point Inflation AirFrame technology makes set up easy
- Weathershield™ Pro double coated polyester fabric protects against wind, rain and UV rays
- QuickPitch™ Guying System saves time
- Dual-Pitch™ Roof System increases headroom, deflects wind and sheds water
- Internal return to create a tight seal to the side of your motorhome or caravan
- Width: 2600 mm

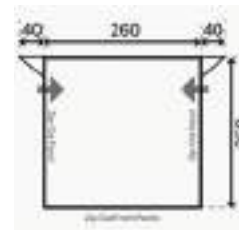

Dimensions W x H x D (mm): 2600 x 2800 x 2500

Min. Connection Height (mm): 2650

Max. Connection Height (mm): 2800

Weight (kg): 23.4

Ref No. 9600027347

For specifications see p.44

RALLY AIR PRO 330 XL

- Inflatable static awning for caravans or motorhomes
- Single Point Inflation AirFrame technology makes set up easy
- Weathershield™ Pro double coated polyester fabric protects against wind, rain and UV rays
- QuickPitch™ Guying System saves time
- Dual-Pitch™ Roof System increases headroom, deflects wind and sheds water
- Internal return to create a tight seal to the side of your motorhome or caravan
- Width: 3300 mm

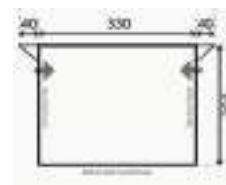

Dimensions W x H x D (mm): 3300 x 2800 x 2500

Min. Connection Height (mm): 2650

Max. Connection Height (mm): 2800

Weight (kg): 25

Ref No. 9600027348

For specifications see p.44



WEATHERSHIELD™ PRO

Weathershield™ Pro double coated polyester fabric



MESH FLYSCREEN

Designed for Australian conditions with high-quality flyscreens for increased ventilation



WEATHERSHIELD™ PRO



AIR FRAME



SINGLE POINT INFLATION



QUICK PITCH™



DUAL-PITCH™



LIMPET™ READY



RALLY AIR PRO D/A

Enjoy more flexibility on your holiday

Designed to suit a wide range of caravan and motorhomes, Rally AIR Drive-Away awnings allows you to leave your awning on site while you explore the local area. The Single Point Inflation AirFrame technology ensures a fast set up with minimum fuss. Simply connect the awning tunnel to your vehicle by throwing the attached webbing straps over

the RV, or with the use of a driveaway kit. Conventional steel and fibreglass poles are replaced with interlinked inflatable AirPoles, enabling you to easily inflate and deflate the awning in no time at all. It also comes standard with a 2.2 l pump, 3.6 m connection straps, peg pack, manual and a carry bag.



QUICKPITCH™ GUYING SYSTEM

Set up in seconds. Peg the bottom strap taut and adjust the buckle to apply tension



SINGLE POINT INFLATION

Single Point Inflation awnings inflate from just one external inflation point



ADJUSTABLE AWNING TUNNEL

Configure the height of the connecting awning tunnel with adjustable webbing straps

RALLY AIR PRO 260 D/A

- Inflatable driveway awning for motorhomes
- Single Point Inflation AirFrame technology makes set up easy
- Weathershield™ Pro double coated polyester fabric protects against wind, rain and UV rays
- QuickPitch™ Guying System saves time
- Dual-Pitch™ Roof System increases headroom, deflects wind and sheds water
- Adjustable awning tunnel

Dimensions W x H x D (mm): 2600 x 3000 x 2600

Min. Connection Height (mm): 2200

Max. Connection Height (mm): 3000

Weight (kg): 32.16

Ref No. 9600027349

For specifications see p.44

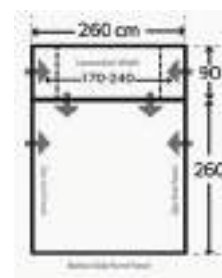

RALLY AIR PRO 330 D/A

- Inflatable driveway awning for motorhomes
- Single Point Inflation AirFrame technology makes set up easy
- Weathershield™ Pro double coated polyester fabric protects against wind, rain and UV rays
- QuickPitch™ Guying System saves time
- Dual-Pitch™ Roof System increases headroom, deflects wind and sheds water
- Adjustable awning tunnel

Dimensions W x H x D (mm): 3300 x 3000 x 2600

Min. Connection Height (mm): 2200

Max. Connection Height (mm): 3000

Weight (kg): 34

Ref No. 9600027351

For specifications see p.44

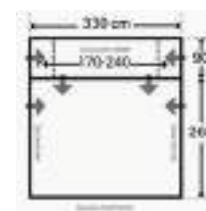

WEATHERSHIELD™ PRO

Weathershield™ Pro double coated polyester fabric



DUAL-PITCH™ ROOF SYSTEM

Increases headroom, ensures effective wind deflection and efficiently sheds water



WEATHERSHIELD™
PRO



AIR FRAME



SINGLE POINT
INFLATION



QUICK PITCH™



DUAL-PITCH™



CAMPERVAN AWNINGS

SUNSHINE AIR PRO VW

Ultimate flexibility on camping adventures

The Dometic Sunshine AIR Pro VW is an inflatable static awning that offers an extended space attached to the side of your campervan. You can use it for day trips, weekend getaways or camping trips where all you want is a little bit of extra space and a roof over your head. It is easy to set up with the inbuilt designed AirPoles that simply need to

be pumped using the 2.2 l pump that comes included. It also comes standard with two guyropes, a clamp pole, three clamps, a peg pack, a manual and a carry bag. It's easy to carry anywhere and only weighs 8.5 kg.



SINGLE POINT INFLATION

Single Point Inflation awnings inflate from just one external inflation point

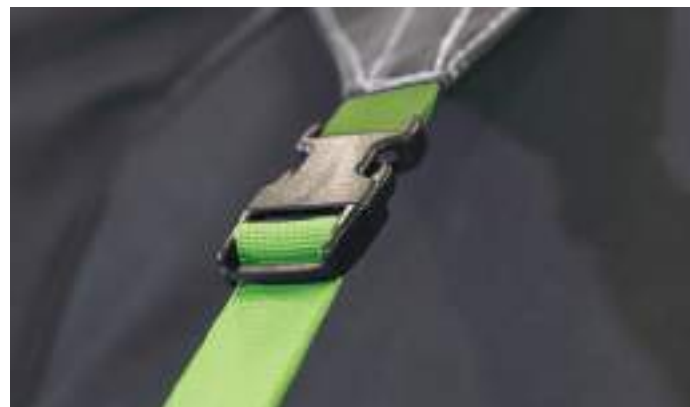

GUYROPE STRAPS

Guyropes add stability and improve performance in adverse weather conditions



SUNSHINE AIR PRO VW

- Inflatable campervan awning
- Single Point Inflation AirFrame technology
- Weathershield™ Pro material
- Static rail mounted awning
- Easy to set up
- Durable and water-resistant

Dimensions W x H x D (mm): 2400 x 2100 x 1950

Min. Connection Height (mm): 1800

Max. Connection Height (mm): 2100

Weight (kg): 8.5

RefNo. 9600027353

For specifications see p.44



WEATHERSHIELD™
PRO



QUICK AND EASY SET UP



SINGLE POINT
INFLATION



AIR FRAME



SPECIFICATIONS					
	RALLY AIR PRO 260 XL	RALLY AIR PRO 330 XL	RALLY AIR PRO 260 D/A	RALLY AIR PRO 330 D/A	SUNSHINE AIR PRO VW
INFLATABLE AWNINGS					
Ref No.	9600027347	9600027348	9600027349	9600027351	9600027353
Dimensions W x H x D (mm)	2600 x 2800 x 2500	3300 x 2800 x 2500	2600 x 3000 x 2600	3300 x 3000 x 2600	2400 x 2100 x 1950
Min. Connection Height (mm)	2650	2650	2200	2200	1800
Max. Connection Height (mm)	2800	2800	3000	3000	2100
Weight (kg)	23.4	25	32.16	34	8.5
Fabric type	Weathershield™ Pro	Weathershield™ Pro	Weathershield™ Pro	Weathershield™ Pro	Weathershield™ Pro
Frame type	Inflatable	Inflatable	Inflatable	Inflatable	Inflatable
Key features					
Single Point Inflation	•	•	•	•	•
Dual-Pitch™ roof system	•	•	•	•	–
QuickPitch™ guying system	•	•	•	•	–
Limpet™ ready	•	•	–	–	–
Static awning	•	•	–	–	•
Drive-Away awning	–	–	•	•	–
Scope of delivery					
Heavy-duty carry bag	•	•	•	•	•
Hand pump	•	•	•	•	•
Pegs	•	•	•	•	•
Storm straps	–	–	–	–	•





DRIVE-AWAY ATTACHMENT OPTIONS

Dometic awnings are designed to fit vehicles from 2200 - 3000 mm in height. Specifically designed for secure attachment to most caravan and motorhomes, maximise your awnings performance and your

enjoyment of it. So which best suits you and your RV? Let's look at the options, starting with the guy line: Guy line, velcro loops and keder methods are explained below.



GUY LINE

The quickest method. Throw the guy lines, attached to the top corners of the tunnel, over the vehicle and either peg down on the other side or tie to the wheels. To driveaway, simply untie/unpeg and throw them back over.



DRIVE-AWAY KITS

Drive-away kits offer a secure way to attach your awning to your vehicle. Simply connect the figure-of-8 strip to the keder along one edge before attaching the pre-sewn awning beading along the other. To driveaway, slide the figure-of-8 out of position and leave the awning free standing on your pitch.



DRIVE-AWAY KITS EXAMPLE

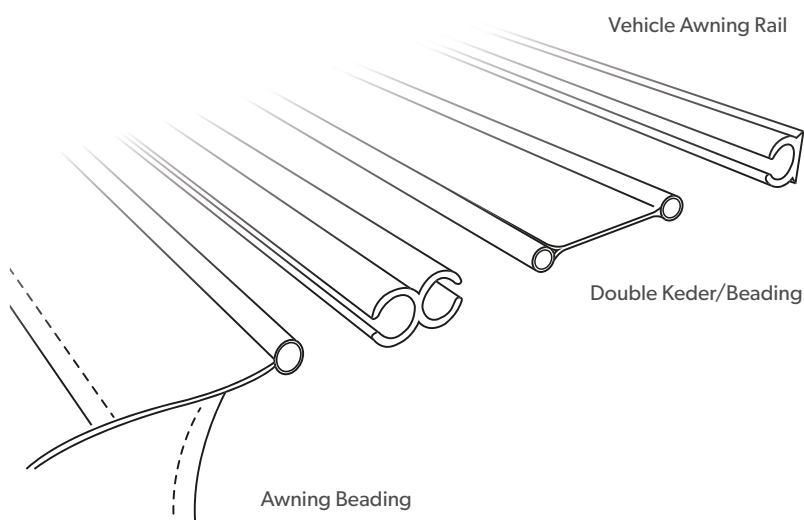

TWIN DRIVE-AWAY KIT KEDER

Connect to the front channel of cassette awnings or a pre-installed awning rail. 4 mm and 6 mm Twin Keder Drive-Away Kit. Available in 3 m and 4 m lengths.



MAGNETIC DRIVE-AWAY KIT

6 mm keder to magnetic system. Guying loops included (guy lines not included). 3 m length.



LIMPET™ SUCTION DRIVE-AWAY KIT

6 mm keder to Limpet™ Fix System. Supplied with six Limpets™. 3 m length.



VELCRO LOOPS

Velcro straps are quick to attach to your vehicle's roof rails, if available. Connected from the top edge of the tunnel to the rail, simply release the hoops and driveaway.



AWNING ACCESSORIES

DRIVE-AWAY AWNING ATTACHMENT OPTIONS

1 YEAR
WARRANTY



TWIN DRIVE-AWAY KIT

Awning fitment accessory, available in 3 & 4 m lengths

- Available in 3 or 4 m lengths
- Twin keder
- Suits most awnings
- Reinforced stitching

3 M TWIN DRIVE-AWAY KIT

Ref No. 9600027357

4 M TWIN DRIVE-AWAY KIT

Ref No. 9600027358



MAGNETIC DRIVE-AWAY KIT

Awning fitment accessory

- Simple installation
- 6 mm keder to magnetic system
- Suits most vehicles

Ref No. 9600027359



LIMPET™ SUCTION DRIVE-AWAY KIT

Awning fitment accessory

- 6 mm keder to Limpet™ fix system
- Supplied with 6 Limpets™
- Reinforced stitching

Ref No. 9600027360

1 YEAR
WARRANTY

FOOTPRINTS

Tough non-breathable awning footprints reduce condensation when pitched on wet ground.

- Tailored to fit
- Non-breathable
- Carry bag included

RALLY 260 AWNING FOOTPRINT

Ref No. 9600027354

RALLY 330 AWNING FOOTPRINT

Ref No. 9600027355



PITCHING & REPAIRING



1 YEAR WARRANTY

GALE 12 V PUMP

Electric pump

- Powerful inflation
- Automatic cut-off
- 6 fitting nozzles

Ref No. 9600027346



REPAIR TAPE

Repair product

- Self adhesive
- Transparent finish
- Flexible

REPAIR TAPE 50 CM

Ref No. 9120000440

REPAIR TAPE 30 M

Ref No. 9120000441



SEAM SEALANT

Repair product

- Colourless
- Applicator nozzle
- Flexible

Ref No. 9120000443



REPAIR SOLUTION

Repair product

- Fixes holes & rips
- Used with Dometic repair tape
- Flexible

Ref No. 9120000442

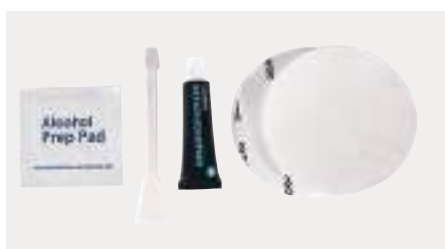

INFLATABLE REPAIR KIT

Repair product

- Self adhesive
- High-tensile strength
- Flexible

Ref No. 9120000444



TENT & AWNING REPAIR KIT

Repair product

- Self adhesive
- High tensile strength
- Flexible

Ref No. 9120000445



LIMPET™ FIX KIT

Fixing tool

Fix the rear wall of your awning to your vehicle by simply attaching the limpet through the pre-cut holes in the rear of the awning and fastening to smooth surface.

- Simple installation
- Suits most vehicles
- Pack of eight

Ref No. 9120000424



LIMPET™ HOLE PUNCH

Fixing tool

Extra holes to suit your caravan or motorhome can be made using the Limpet™ Hole Punch.

- Durable construction
- Suits most awnings
- Non-slip handle

Ref No. 9120000425

/ FRIDGE / FREEZER & COOLERS
/ ICEBOXES
/ ACCESSORIES

PORT DOMETIC REFRIGER





ABLE

CFX

RATION



COOLING ON THE MOVE

Just because you're far from the nearest restaurant, it doesn't mean you can't enjoy a delicious meal, washed down with a cold beverage. Dometic's range of reliable, high-performance solutions will keep you well fed and refreshed.



PORTABLE REFRIGERATION

If you have access to a power source, and you plan on being away for an extended period of time, we provide a range of high-performance fridge/freezers to meet your needs. Because they are compatible with almost all on-board or mains power supplies, you can use them anywhere in the world. And depending on where you will be staying, you can choose between three different cooling technologies: thermoelectric, absorption or compressor.

REFRIGERATORS

We started out making refrigerators, so it's not surprising that more outdoor people use our cooling products than any other brand. Dometic refrigeration solutions come with features you will not find anywhere else, including automatic locking systems, versatile racking, adjustable shelf guards and more.

COOKING

Cooking outdoors is one of life's great pleasures. That's why we make every effort to satisfy the tastes of outdoor chefs around the world. Our cooking solutions are among the best you will find anywhere. Easy to set up, easy to use and easy to keep clean, you can look forward to making dinner (or lunch) to the sound of birdsong for many years to come.



3 YEAR WARRANTY

+ additional 2 year (parts only) compressor

THE POWER TO BE PRESENT

THE ULTIMATE PORTABLE FRIDGE/FREEZER

Take control of outdoor adventures like never before with the Dometic CFX3. Enjoy fresher food at your fingertips thanks to Dometic's market leading VMISO³ variable speed compressor with optimised software for better cooling, freezing and power consumption. The CFX3 features durable fender frames that protect the edges of the fridge/freezer, making it ideal for rugged trips. Strong, spring-loaded aluminium handles make it easy to lift and carry. Set the cooling temperature of your CFX3 on the TFT display screen and pack all your

favourite foods. Download the CFX3 app and roam free from worry. Once your CFX3 is connected through your phone, you can set the ideal temperature, and get a detailed history of energy consumption and temperatures. We also offer a range of accessories to get the most out of your fridge/freezer, including a durable insulated protective cover and a fridge slide for easy access to your favourite items.



USER-FRIENDLY INTERFACE

Weatherproof high-resolution user interface displays operating status



CONVENIENT CFX3 APP

Temperature control and performance monitoring via CFX3 app



RUGGED CONSTRUCTION

ExoFrame construction protects the unit from damage

BENEFITS OF CFX3

- Heavy-duty yet lightweight ExoFrame construction with fender frame protected edges and aluminium alloy handles
- Powerful VMISO³ compressor cooling technology efficiently refrigerates and deep-freezes to -22°C
- Easy-to-read high-resolution colour display and soft touch buttons enabling seamless control and monitoring of fridge/freezer performance
- CFX3 app allows temperature control via Bluetooth or WiFi and provides performance history
- 3-stage battery protection system prevents dead car battery or allows deep draw on dual batteries
- Gasket Technology provides a superior seal to retain cool air and minimise power consumption



reddot award 2020
best of the best

For further details
on awards see p.61



FOOD & BEVERAGE



240 V AC



12 / 24 V DC



BLUETOOTH



WIFI



FRIDGE / FREEZER

Model	Ref No.	Storage capacity (l)	Dimensions W x H x D (mm)	Weight (kg)
CFX3 25	9600028368	25	342 x 420 x 569	13.4
CFX3 35	9600028616	36	398 x 407 x 694	16.9
CFX3 45	9600028617	46	398 x 476 x 694	18.7
CFX3 55	9600028619	55	720 x 480 x 455	20.4
CFX3 55IM	9600028620	53	720 x 480 x 455	21.3
CFX3 75DZ	9600028621	75 (45/30)	892 x 472 x 495	27.8
CFX3 95DZ	9600028622	94 (55/39)	962 x 472 x 530	29.8



FLEXIBLE POWER OPTIONS

Powered by AC and DC battery



EFFICIENT POWER CONSUMPTION

Optimised VMISO³ compressor cooling technology



EASY TO CARRY

Strong aluminium carry handles



YEARS OF INNOVATION FOR COOLING PERFECTION

With the new Dometic CFX3, you have control of your experiences like never before. On-road, off-road, or in the backyard, your ordinary and extraordinary adventures will be fuelled by fresher, safer food, less waste and more confidence, giving you the power to be present in any moment.



DOMETIC CFX3 55IM

Portable fridge and ice maker, or freezer, 53 l

This ultimate portable fridge/freezer produces seriously impressive cooling, allowing you to bring more of the food and drinks you love wherever you go. Its robust design is built for tough outdoor use. Enjoy efficient cooling and freezing with convenience thanks to a mobile app which puts the control of your Dometic CFX3 at your fingertips. Go further, stay longer, and experience more.



FEATURES

- Generous storage capacity of 53 l to fit 83 cans
- Rapid Freeze Plate and included silicone ice trays produces ice in a matter of hours
- Heavy-duty yet lightweight ExoFrame construction with ExoFrame protected edges and aluminium alloy handles
- Powerful VMSO³ compressor cooling technology efficiently refrigerates and deep-freezes to -22°C
- Easy-to-read high-resolution colour display and soft touch buttons enabling seamless control and monitoring of fridge/freezer performance
- 3-stage battery protection system prevents dead car battery or allows deep draw on dual batteries
- CFX3 app allows temperature control via Bluetooth or WiFi and provides performance history





CFX3 APP*

For Android and iOS

The Dometic CFX3 app allows you to monitor and control your fridge/freezer whilst on the move.



BLUETOOTH & WIFI ENABLED APP FEATURES

- Bluetooth & WiFi enabled smart phone app
- Download the CFX3 app for free in the App Store or on Google Play. Simply search 'CFX3'
- Set & monitor your current CFX3 compartment temperatures
- Monitors temperature history & tracks DC energy consumption graphically
- Displays supply voltage type (AC or DC)
- Displays DC voltage level
- Turn CFX3 on/off or just one compartment (DZ models)
- Temperature alarm function
- Set or review your preferred battery protection level
- Low voltage alert
- Lid open alert

* The new CFX3 app is not backwards compatible with previous CFX models.



GENUINE DOMETIC WAECO COMPRESSORS WITH INTEGRATED AC ELECTRONICS

Genuine Dometic Waeco compressors have been developed with input from Dometic engineers based on demanding Australian climate, usage and road conditions. Proprietary VMISO³ electronics support the extreme (-22 °C) performance capability whilst contributing to the power efficiency of the Dometic CFX3 range.

VMISO³ VARIABLE MOTOR SPEED OPTIMISATION – POWERFUL, EFFICIENT, RELIABLE

Now with third generation VMISO³ control logic, the CFX3 range takes performance and efficiency to the next level. Differential temperature activated compressor speed variation optimises cooling performance and energy efficiency, whilst ramped compressor speed soft-start/stop logic reduces compressor on/off cycle noise.

The compressor runs at turbo speed when needed, economy speed when possible, with moderate speeds in-between & smooth transitions between speeds. All of this means faster yet more efficient cooling in a wide range of conditions, and less wear and tear on the compressor.



DOMETIC CFX3 25

Portable fridge or freezer, 25 l

- Generous storage capacity of 25 l to fit 33 cans
- Heavy-duty yet lightweight ExoFrame construction with fender frame protected edges and aluminium alloy handles
- Powerful VMISO³ compressor cooling technology efficiently refrigerates and deep-freezes to -22°C
- Easy-to-read high-resolution colour display and soft touch buttons enabling seamless control and monitoring of fridge/freezer performance
- CFX3 app allows temperature control via Bluetooth or WiFi and provides performance history
- 3-stage battery protection system prevents dead car battery or allows deep draw on dual batteries
- Gasket technology provides a superior seal to retain cool air and minimise power consumption



DOMETIC CFX3 35

Portable fridge or freezer, 36 l

- Generous storage capacity of 36 l to fit 50 cans
- Heavy-duty yet lightweight ExoFrame construction with fender frame protected edges and aluminium alloy handles
- Powerful VMISO³ compressor cooling technology efficiently refrigerates and deep-freezes to -22°C
- Easy-to-read high-resolution colour display and soft touch buttons enabling seamless control and monitoring of fridge/freezer performance
- CFX3 app allows temperature control via Bluetooth or WiFi and provides performance history
- 3-stage battery protection system prevents dead car battery or allows deep draw on dual batteries
- Gasket technology provides a superior seal to retain cool air and minimise power consumption



DOMETIC CFX3 45

Portable fridge or freezer, 46 l

- Generous storage capacity of 46 l to fit 67 cans
- Heavy-duty yet lightweight ExoFrame construction with fender frame protected edges and aluminium alloy handles
- Powerful VMISO³ compressor cooling technology efficiently refrigerates and deep-freezes to -22°C
- Easy-to-read high-resolution colour display and soft touch buttons enabling seamless control and monitoring of fridge/freezer performance
- CFX3 app allows temperature control via Bluetooth or WiFi and provides performance history
- 3-stage battery protection system prevents dead car battery or allows deep draw on dual batteries
- Gasket technology provides a superior seal to retain cool air and minimise power consumption



DOMETIC CFX3 55

Portable fridge or freezer, 55 l

- Generous storage capacity of 55 l to fit 85 cans
- Heavy-duty yet lightweight ExoFrame construction with fender frame protected edges and aluminium alloy handles
- Powerful VMISO³ compressor cooling technology efficiently refrigerates and deep-freezes to -22°C
- Easy-to-read high-resolution colour display and soft touch buttons enabling seamless control and monitoring of fridge/freezer performance
- CFX3 app allows temperature control via Bluetooth or WiFi and provides performance history
- 3-stage battery protection system prevents dead car battery or allows deep draw on dual batteries
- Gasket technology provides a superior seal to retain cool air and minimise power consumption



DOMETIC CFX3 55IM

Portable fridge with ice maker, or freezer, 53 l

- Generous storage capacity of 53 l to fit 83 cans
- Rapid Freeze Plate and included silicon ice trays produces ice in a matter of hours
- Heavy-duty yet lightweight ExoFrame construction with fender frame protected edges and aluminium alloy handles
- Powerful VMISO³ compressor cooling technology efficiently refrigerates and deep-freezes to -22°C
- Easy-to-read high-resolution colour display and soft touch buttons enabling seamless control and monitoring of fridge/freezer performance
- 3-stage battery protection system prevents dead car battery or allows deep draw on dual batteries
- CFX3 app allows temperature control via Bluetooth or WiFi and provides performance history



DOMETIC CFX3 75DZ

Portable fridge and freezer, 75 l

- Generous storage capacity of 75 l to fit 113 cans (45 l and 30 l compartments)
- Heavy-duty yet lightweight ExoFrame construction with fender frame protected edges and aluminium alloy handles
- Powerful VMISO³ compressor cooling technology efficiently refrigerates and deep-freezes to -22°C
- Easy-to-read high-resolution colour display and soft touch buttons enabling seamless control and monitoring of fridge/freezer performance
- CFX3 app allows temperature control via Bluetooth or WiFi and provides performance history
- 3-stage battery protection system prevents dead car battery or allows deep draw on dual batteries
- Dual storage compartments with independent temperature control for simultaneous cooling and freezing



DOMETIC CFX3 95DZ

Portable fridge and freezer, 95 l

- Generous storage capacity of 94 l to fit 133 cans (55 l and 39 l compartments)
- Heavy-duty yet lightweight ExoFrame construction with fender frame protected edges and aluminium alloy handles
- Powerful VMISO³ compressor cooling technology efficiently refrigerates and deep-freezes to -22°C
- Easy-to-read high-resolution colour display and soft touch buttons enabling seamless control and monitoring of fridge/freezer performance
- CFX3 app allows temperature control via Bluetooth or WiFi and provides performance history
- 3-stage battery protection system prevents dead car battery or allows deep draw on dual batteries
- Dual storage compartments with independent temperature control for simultaneous cooling and freezing



reddot award 2020
best of the best

The Dometic CFX3 portable fridge/freezer, was a winner of the Red Dot Award for Outstanding Design Quality. Jurors comprising of experienced experts from different disciplines from all over the world awarded the CFX3 portable fridge/freezer as a winner thanks to the product aesthetics and its ability to set new design standards in our industry.

SPECIFICATIONS	DOMETIC CFX3 25 Portable fridge or freezer	DOMETIC CFX3 35 Portable fridge or freezer	DOMETIC CFX3 45 Portable fridge or freezer
Storage capacity (l)	25	36	46
Can count (375 ml)	33	50	67
Voltage	12/24 V DC and 100 – 240 V AC	12/24 V DC and 100 – 240 V AC	12/24 V DC and 100 – 240 V AC
USB charging outlet	5 V / 2 A rating	5 V / 2 A rating	5 V / 2 A rating
Power consumption (DC 12 V)	Average current draw x running time. Average 0.92 Ah/h (@12 V, 4 °C set, 32 °C ambient, Bluetooth on, WiFi off)	Average current draw x running time. 0.98 Ah/h (@12 V, 4 °C set, 32 °C ambient, Bluetooth on, WiFi off)	Average current draw x running time. 1.03 Ah/h (@12 V, 4 °C set, 32 °C ambient, Bluetooth on, WiFi off)
Temperature range	+10 °C to -22 °C (Minimum setting of -18 °C recommended for normal usage)	+10 °C to -22 °C (Minimum setting of -18 °C recommended for normal usage)	+10 °C to -22 °C (Minimum setting of -18 °C recommended for normal usage)
Insulation	CFC-free PU foam, generous thickness	CFC-free PU foam, generous thickness	CFC-free PU foam, generous thickness
System	Dometic Waeco ACV20DC compressor with integrated VMISO ³ electronics, low voltage protection, adjustable for leisure and starter battery, AC mains priority circuit, dynamically ventilated fin/tube condenser, aluminium rollbond evaporator	Dometic Waeco ACV20DC compressor with integrated VMISO ³ electronics, low voltage protection, adjustable for leisure and starter battery, AC mains priority circuit, dynamically ventilated fin/tube condenser aluminium rollbond evaporator	Dometic Waeco ACV20DC compressor with integrated VMISO ³ electronics, low voltage protection, adjustable for leisure and starter battery, AC mains priority circuit, dynamically ventilated fin/tube condenser aluminium rollbond evaporator
Material	Cabinet & lid: polypropylene Handles: aluminium alloy Hinges: aluminium alloy & stainless steel	Cabinet & lid: polypropylene Handles: aluminium alloy Hinges: aluminium alloy & stainless steel	Cabinet & lid: polypropylene Handles: aluminium alloy Hinges: aluminium alloy & stainless steel
Colour	Body: dark grey; Lid: light grey	Body: dark grey; Lid: light grey	Body: dark grey; Lid: light grey
Weight (kg)	13.4	16.9	18.7
Dimensions W x H x D (mm)	342 x 420 x 569	398 x 407 x 694	398 x 476 x 694
Quality features	Bluetooth & WiFi enabled, detachable lid, interior light, drain plug, CFX3 VMISO ³ electronics, USB port, TFT LCD display (dimnable), 3-stage battery protection, 4 x M6 nutserts in base	Bluetooth & WiFi enabled, detachable lid, interior light, drain plug, CFX3 VMISO ³ electronics, USB port, TFT LCD display (dimnable), 3-stage battery protection, anti-condensation heating, 4 x M6 nutserts in base	Bluetooth & WiFi enabled, detachable lid, interior light, drain plug, CFX3 VMISO ³ electronics, USB port, TFT LCD display (dimnable), 3-stage battery protection, anti-condensation heating, 4 x M6 nutserts in base
Scope of delivery	DC and AC connection cables, removable wire basket, spring-loaded carrying handles	DC and AC connection cables, removable wire baskets, spring-loaded carrying handles	DC and AC connection cables, removable wire baskets, spring-loaded carrying handles
Ref No.	9600028368	9600028616	9600028617



CFX3 25

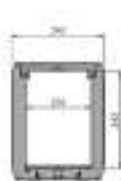

CFX3 35



CFX3 45



+ additional 2 year (parts only) compressor

DOMETIC CFX3 55 Portable fridge or freezer	DOMETIC CFX3 55IM Portable fridge and ice maker, or freezer	DOMETIC CFX3 75DZ Portable fridge and freezer	DOMETIC CFX3 95DZ Portable fridge and freezer
55	53	75	94
85	83	113 (68/45)	133 (81/52)
12/24 V DC and 100 – 240 V AC	12/24 V DC and 100 – 240 V AC	12/24 V DC and 100 – 240 V AC	12/24 V DC and 100 – 240 V AC
5 V / 2 A rating	5 V / 2 A rating	5 V / 2 A rating	5 V / 2 A rating
Average current draw x running time. 1.10 Ah/h (@12 V, 4 °C set, 32 °C ambient, Bluetooth on, WiFi off)	Average current draw x running time. 1.20 Ah/h (@12 V, 4 °C set, 32 °C ambient, ice maker on/ maintenance, Bluetooth on, WiFi off)	Average current draw x running time. 3.04 Ah/h (@12 V, 4 °C (large), -15 °C (small), 32 °C ambient, Bluetooth on, WiFi off)	Average current draw x running time. 3.57 Ah/h (@12 V, 4 °C (large), -15 °C (small), 32 °C ambient, Bluetooth on, WiFi off)
+10 °C to -22 °C (Minimum setting of -18 °C recommended for normal usage)	+10 °C to -22 °C (Minimum setting of -18 °C recommended for normal usage)	+10 °C to -22 °C (Minimum setting of -18 °C recommended for normal usage)	+10 °C to -22 °C (Minimum setting of -18 °C recommended for normal usage)
CFC-free PU foam, generous thickness	CFC-free PU foam, generous thickness	CFC-free PU foam, generous thickness	CFC-free PU foam, generous thickness
Dometic Waeco ACV20DC compressor with integrated VMISO ³ electronics, low voltage protection, adjustable for leisure and starter battery, AC mains priority circuit, dynamically ventilated fin/tube condenser, aluminium rollbond evaporator	Dometic Waeco ACV20DC compressor with integrated VMISO ³ electronics, low voltage protection, adjustable for leisure and starter battery, AC mains priority circuit, dynamically ventilated fin/tube condenser, aluminium rollbond evaporator	Dometic Waeco ACV20DC compressor with integrated VMISO ³ electronics, low voltage protection, adjustable for leisure and starter battery, AC mains priority circuit, dynamically ventilated fin/tube condenser, aluminium rollbond evaporator	Dometic Waeco ACV25DC compressor with integrated VMISO ³ electronics, low voltage protection, adjustable for leisure and starter battery, AC mains priority circuit, dynamically ventilated fin/tube condenser, aluminium rollbond evaporator
Cabinet & lid: polypropylene Handles: aluminium alloy Hinges: aluminium alloy & stainless steel	Cabinet & lid: polypropylene Handles: aluminium alloy Hinges: aluminium alloy & stainless steel	Cabinet: steel & polypropylene Lid: polypropylene Handles: aluminium alloy Hinges: aluminium alloy & stainless steel	Cabinet: steel & polypropylene Lid: polypropylene Handles: aluminium alloy Hinges: aluminium alloy & stainless steel
Body: dark grey; Lid: light grey	Body: dark grey; Lid: light grey	Body: dark grey; Lid: light grey	Body: dark grey; Lid: light grey
20.4	21.3	27.8	29.8
720 x 480 x 455	720 x 480 x 455	892 x 472 x 495	962 x 472 x 530
Bluetooth & WiFi enabled, detachable/ reversible lid, interior light, drain plug, CFX3 VMISO ³ electronics, USB port, TFT LCD display (dimnable), 3-stage battery protection, anti-condensation heating, 4 x M6 nutserts in base	Bluetooth & WiFi enabled, ice maker, detachable/reversible lid, interior light, drain plug, CFX3 VMISO ³ electronics, USB port, TFT LCD display (dimnable), 3-stage battery protection, anti-condensation heating, 4 x M6 nutserts in base	Bluetooth & WiFi enabled, dual zone refrigeration or freezing, detachable/ reversible lids, interior lights, drain plugs, CFX3 VMISO ³ electronics, USB port, TFT LCD display (dimnable), 3-stage battery protection, anti- condensation heating, 4 x M6 nutserts in base	Bluetooth & WiFi enabled, dual zone refrigeration or freezing, detachable/ reversible lids, interior lights, drain plugs, CFX3 VMISO ³ electronics, USB port, TFT LCD display (dimnable), 3-stage battery protection, anti-condensation heating, 4 x M6 nutserts in base
DC and AC connection cables, 2 x removable wire baskets, spring-loaded carrying handles	DC and AC connection cables, 2 x removable wire baskets, spring- loaded carrying handles, ice maker housing with lid, 2 x ice trays with lid	DC and AC connection cables, 3 x removable wire baskets, spring-loaded carrying handles	DC and AC connection cables, 3 x removable wire baskets, spring-loaded carrying handles
9600028619	9600028620	9600028621	9600028622

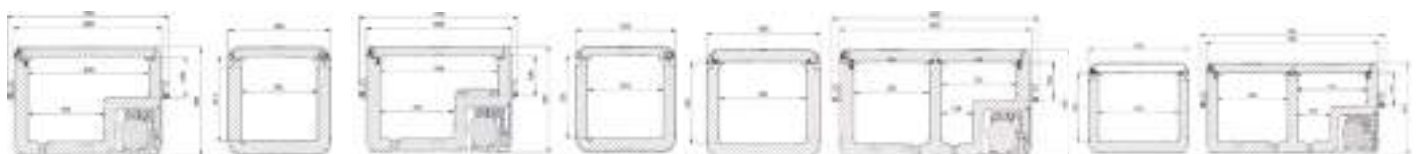

CFX3 55

CFX3 55IM

CFX3 75DZ

CFX3 95DZ

ACCESSORIES

CFX3 PROTECTIVE COVERS

Accessories for the portable fridge/freezer range



Whether it's downhill, off-road, in the outback or in the backyard, the CFX3 protective covers provide the ultimate peace of mind for CFX3 owners. Not only does the thermoformed EVA and 1200D nylon construction protect the CFX3 from dirt, dust and damage, it also looks great in the back of the 4WD thanks to its elegant charcoal design. The tight-fitting four-piece design assembles with concealed

zips and the clip-on lid cover means that detaching the lid cover to open the lid is a thing of the past. CFX3 protective covers come with integrated storage pockets for carrying power cords and other valuables. Equip a CFX3 portable fridge/freezer with a protective cover for the ultimate confidence to travel further and experience more.

- Made from tough 1200D nylon and thermoformed EVA
- Protects against dirt, dust, sand, moisture and water splashes
- Integrated storage pockets with zipper at the front and sides of the cover
- Four-piece design fits securely against the CFX3

Product	Ref No.
DOMETIC CFX3-PC25	9600028649
DOMETIC CFX3 PC35	9600026468
DOMETIC CFX3 PC45	9600026469
DOMETIC CFX3 PC55 / 55IM	9600026470
DOMETIC CFX3 PC75	9600026471
DOMETIC CFX3 PC95	9600026472



EASY ACCESS

Contoured cutout for easy access to CFX3 user interface



HEAVY-DUTY CONSTRUCTION

Resilient thermoformed EVA panels protect the CFX3 from scuffing



A PERFECT FIT

The four-piece design fits securely against the CFX3



ADDED STORAGE

Integrated storage pockets for carrying cords and other accessories



VENT CLEARANCE

Avoids overheating and ensures reliable performance



PREMIUM FINISH

Durable fabric in a modern charcoal colour



CF/CFF SERIES

A VERSATILE PARTNER FOR LIFE'S GREAT ADVENTURES

CF SERIES

The compact CF series that can go anywhere

With a handy shoulder strap (CF 11 only) and carry handles, the CF Series is a range of compact fridge/freezers that you can take anywhere. Super-slim and easy to fit in the smallest of spaces, the CF fridge/freezers can deep freeze food and drinks with minimal power consumption. Offering greater convenience the CF Series is even lighter than its predecessor thanks to its new compact compressor.



240 V AC



12 / 24 V DC



SOLAR COMPATIBLE



FRIDGE / FREEZER

CFF SERIES

A great partner for embarking on life's greatest adventures

This series is designed to keep adventurers off the grid for longer, integrating impressive cooling or freezing with efficient interior storage. Whether it's storing for short stays, long trip dinners, or wine and soft drink bottles, the CFF series makes the most of its optimised capacity and allows everyone to enjoy everything cool that Dometic has to offer.

CFF 70DZ PACK COMPRESSOR FRIDGE AND FREEZER



NEW

The Dometic CFF 70DZ Pack features dual storage compartments with independent temperature control for simultaneous cooling and freezing in any combination, making it a versatile portable fridge and freezer that is flexible, and remarkably user friendly. It comes with a digital electronic control system and can keep its interior as low as -18°C . Enjoy the flexibility to choose between running the CFF 70DZ as a fridge, freezer or both, removing the boundaries when it comes to deciding what to pack for a trip. The CFF range was designed for

more effective use of storage space and temperature distribution, with dimmable digital displays making it easy to set and monitor in any ambient light. The CFF range is a perfect choice for the outdoor enthusiast to upgrade from a traditional icebox. The CFF 70DZ Pack includes an insulated cover that helps protect your fridge or freezer from dirt, dust, sand, moisture, and water splashes. This new insulated cover is the next step in caring for your CFF 70DZ.



DOMETIC COOLFREEZE CF 11

Portable fridge or freezer, 13 cans

- Extremely compact, super-slim design
- Refrigeration and deep-freezing
- With shoulder strap for easy transport
- Compact compressor, therefore light in weight
- 12 or 24 V DC, 100-240 V AC
- Storage volume 10.5 l
- Refrigeration from +10 °C to -18 °C

Not available for sale in NSW.

For more information visit dometic.com



DOMETIC CFF 45 PACK

Portable fridge or freezer, 44 l, insulated cover included

- 44 l of storage for convenient cooling
- Double-sided lid for user-friendly opening
- Fast and excellent cooling and freezing, even in high outside temperatures
- Single compartment allows either refrigeration or freezing
- Can be set between 10°C and -18°C, with the ability to run at -18°C up to 50°C below ambient temperature
- Includes insulated cover with pockets for storing power leads and other fridge accessories



DOMETIC CFF 70DZ PACK

Portable fridge and freezer, 70 l, insulated cover included

- 70 (40/30) l of storage for convenient cooling
- Dual storage compartments with independent temperature control for simultaneous cooling and freezing
- Fast and excellent cooling and freezing, even in high outside temperatures
- Can be set between 10°C and -18°C, in either compartment
- Compact design ensures excellent range of installations
- Includes insulated cover with pockets for storing power leads and other fridge accessories

Gross volume	11 l	44 l	70 (40/30)
Voltage	12/24 V DC, 100 - 240 V AC	12/24 V DC and 100 - 240 V AC	12/24 V DC and 100 - 240 V AC
Power input (AC 230 V)	30 W	-	-
Power consumption (DC 12 V)	Average current draw x running time. Average 0.45 Ah/h ¹	Average current draw x running time. 1.07 Ah/h (@12 V, 4 °C set, 32 °C ambient)	Average current draw x running time. 2.9 Ah/h (@12 V, 4 °C (large), -15 °C (small), 32 °C ambient)
Temperature range	+10 °C to -18 °C, continuously variable via electronic thermostat with digital temperature readout	+10 °C to -18 °C	+10 °C to -18 °C
Insulation	CFC-free PU foam	CFC-free PU foam	CFC-free PU foam
System	Compressor with integrated control electronics, low voltage protection (can be adjusted), electronic fuse/automatic reverse pole protection	Dometic Waeco ACV20DC compressor with integrated VMSO ² electronics, low voltage protection, adjustable for leisure and starter battery, AC mains priority circuit, dynamically ventilated wire/tube condenser, aluminium rollbond evaporator	Dometic Waeco ACV20DC compressor with integrated VMSO ² electronics, low voltage protection, adjustable for leisure and starter battery, AC mains priority circuit, dynamically ventilated wire/tube condenser, aluminium rollbond evaporators
Material	Housing and lid polypropylene	Cabinet & lid: polypropylene Handles: glass filled nylon & powder coated steel Hinges: acetyl	Cabinet: steel Lids: polypropylene Handles: glass filled nylon & powder coated steel Hinges: aluminium alloy & stainless steel
Colour	Body: Dark grey sides, Lid: light grey	Body: dark grey sides with light grey top highlight, Lid: light grey	Body: dark grey, Lids: light grey
Weight (kg)	8.5	18.9	26.4
Dimensions W x H x D (mm)	235 x 358 x 540	715* x 475 x 398 (*590 without handles)	914* x 500 x 443 (*785 without handles)
Quality features	Extremely compact design, electronic thermostat with digital temperature display, 3-stage battery monitor, LED interior light, adjustable shoulder strap, two drink holders, easy and secure fastening with the vehicle safety belt	Double-sided opening lid, interior light, dimmable display, 3-stage battery protection, vertical space for standing wine or soft drink bottles	Dual zone refrigeration or freezing, detachable/reversible lids, interior lights, dimmable display, 3-stage battery protection, vertical space for standing wine or soft drink bottles
Scope of delivery	DC and AC connection cable, carry strap	DC and AC connection cables, removable wire basket, detachable carrying handles, insulated cover	DC and AC connection cables, 2 x removable wire baskets, detachable carrying handles, insulated cover
Ref No.	9600010779	9600028653	9600028328

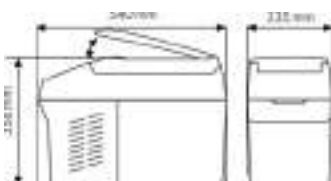

CF 11

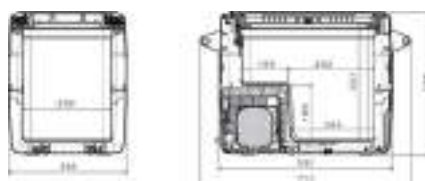

CFF 45 PACK



CFF 70DZ PACK



DOMETIC COOLPRO TCX 14

Portable thermoelectric cooler, 14 l

- Convenient 12 or 24 V DC and 240 V AC cooler
- Cooling down to 1 °C (max. 27 °C below ambient temperature), heats up to +65 °C
- Seven-level temperature regulation
- Priority circuit for mains operation

Dimensions W x H x D (mm): 303 x 328 x 450

Weight (kg): 5.8

Ref No. 9600014289

Not available for sale in NSW.

For more information visit dometic.com

DOMETIC COOLPRO TCX 21

Portable thermoelectric cooler, 21 l

- Convenient 12 or 24 V DC and 240 V AC cooler
- Cooling down to 3 °C (max. 27 °C below ambient temperature), heats up to +65 °C
- Seven-level temperature regulation
- Priority circuit for mains operation

Dimensions W x H x D (mm): 303 x 420 x 450

Weight (kg): 7

Ref No. 9600014290

Not available for sale in NSW.

For more information visit dometic.com



12 / 24 V DC



230 V AC



WARMER/COOLER



ACCESSORIES



DOMETIC CFX-28 FIXING KIT

Fixing kit

- Suitable for the CFX3 25 & CFX 28

Dimensions W x H x D (mm):

250 x 30 x 422

Weight (kg): 1.9

Ref No. 9105306218



DOMETIC CFX FIXING KIT

Fixing kit

- Suits all CFX portable fridge and freezers

Ref No. 9108300002



DOMETIC CFX3-SLD3545

Fridge slide

- Suitable for use with CFX3 35, CFX3 45 and CFX 35W/40W, CFF 45, CF 40/50
- Maximum load capacity of 100 kg

Dimensions W x H x D (mm): 481 x 85 x 735

Extended: D1418 mm (inc. lever)

Weight (kg): 14.2

Ref No. 9610000651



DOMETIC CFX3-SLD55

Fridge slide

- Suitable for use with CFX3 55, CFX3 55IM and legacy CFX models of comparable size
- Maximum load capacity of 100 kg

Dimensions W x H x D (mm):

539 x 85 x 759

Extended: D1496 mm (inc. lever)

Weight (kg): 15.7

Ref No. 9610000652



DOMETIC CFX-SLD75

Fridge slide

- Up to 100 kg max load capacity
- Secure fridge/freezer to slide with tie-down straps or screws from underneath

Dimensions W x H x D (mm):

580 x 79 x 940

Extended: D1710 mm (inc. lever)

Weight (kg): 20.5

Ref No. 9105306633



DOMETIC CFX-SLD95/100

Fridge slide

- Up to 115 kg max load capacity
- Secure fridge/freezer to slide with tie-down straps or screws from underneath

Dimensions W x H x D (mm):

613 x 79 x 1011

Extended: D1850 mm (inc. lever)

Weight (kg): 22

Ref No. 9105306558



DOMETIC CFX CORNER CAP/BRACKETS 75

Corner caps for CFX 75DZW

- For mounting accessory drink holder or bottle opener
- Made from strong acetal material
- Installation tool and screws included

Dimensions W x H x D (mm): 73 x 90 x 48

Ref No. 9600013945



DOMETIC CFX CORNER CAP/BRACKETS 95

Corner caps for CFX 95DZW & CFX 100W

- For mounting accessory drink holder or bottle opener
- Made from strong acetal material
- Installation tool and screws included

Dimensions W x H x D (mm): 90 x 90 x 48

Ref No. 9600013946



DOMETIC COOLPOWER RAPS72 KIT

Battery cradle

- Fits two RAPS battery kits
- Sturdy powder coated cradle
- Connection lead included

Dimensions WxHxD (mm):

232.2 x 215.2 x 450.1

Weight (kg): 1.04

Ref No. 9105303701



DOMETIC TROPICOOOL AC-UFK-T

Fixing kit

- Vehicle fixing kit for TCX 14/21 & TC 14/21
- For secure use of fridge/freezer while on the move
- For safe fastening of cooler
- Heavy duty straps

Ref No. 9105303709



DOMETIC COOLFEEZE AC-UFK

Fixing kit

- Vehicle fixing kit for CF 25 - CF 60

Ref No. 9105303708



DOMETIC COOLFEEZE FRIDGE STAND

Fridge Stand

- Up to 80 kg load capacity

Dimensions H x D (mm): 450 x 330

Weight (kg): 2

Ref No. 9108400101



DOMETIC HWK-DC

DC Hardwiring kit

- 10 AWG cable with eyelets & 15 A blade fuse, 6 m
- Surface or panel mount
- Standard DC socket
- 2-pin threaded socket

Dimensions W x H x D (mm): 115 x 55 x 89

Weight (kg): 1.19

Ref No. 9600024832

NEW

7 YEAR WARRANTY

BUILT TO KEEP YOUR ICE FROZEN FOR DAYS



Our high performance Patrol iceboxes keep ice frozen for days. Built to last trip after trip with thick PU insulated walls, a single piece rotomoulded construction, and a full length hinge pin. More than just a box to put ice in, these iceboxes offer smart features like Patrol's leak proof drain, deep freeze lid seal and one hand rubber latch opening. For extra functionality, a clever accessory dock can house optional accessories including: a bottle opener, cup holder or fishing rod holder.



DOMETIC PATROL

Through heat and dust, pouring rain and mud, Dometic Patrol iceboxes take it all in their stride. The robust one-piece rotomoulded polyethylene design makes the icebox tough enough for years of outdoor adventure. On hikes, rides and climbs, its dependable cool storage make the Patrol an ever present partner. Ready for the challenge, it dares you to go further because it can handle harsh treatment. And every scratch tells a story.

KEY BENEFITS

- Thick PU insulation keeps ice frozen for days
- Large, leak-proof drain makes cleaning easy
- Deep-freeze lid seal ensures no gaps for air to enter or escape
- Rugged construction with one-piece rotomoulded PE
- One-handed rubber latches for convenient opening and closing of the lid



FOOD & BEVERAGE



LARGE DRAIN

Leak-proof drain for easy cleaning



HIGHLY INSULATED

Keeps ice cold for days



EASY ACCESS

Open with one hand thanks to convenient rubber latches



TOUGH DESIGN

One-piece rotomoulded polyethylene



CONVENIENT DOCK (OPTIONAL)

Multi use dock with cup holder, bottle opener and rod holder



CUSTOMISABLE

Each box comes with a set of stickers for personalisation

PATROL

Iceboxes with a sense of adventure

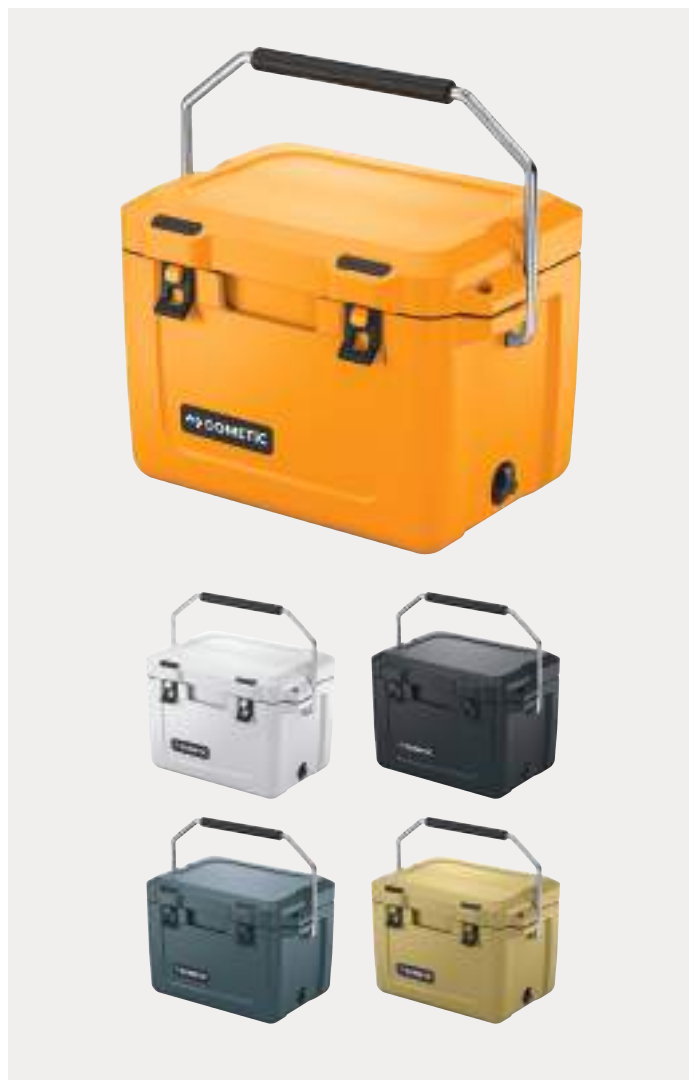

DOMETIC PATROL 20

- Capacity: 15 cans / 18.8 l
- Dimensions W x H x D (mm): 526 x 379 x 356
- Weight (kg): 8
- Available colours: Mist, Slate, Ocean, Olive, Mango

Product	Ref No.
PATR20M (Mist)	9600028784
PATR20S (Slate)	9600028787
PATR20O (Ocean)	9600028790
PATR20OO (Olive)	9600028792
PATR20MS (Mango)	9600028794



DOMETIC PATROL 35

- Capacity: 28 cans / 35.6 l
- Dimensions W x H x D (mm): 691 x 389 x 414
- Weight (kg): 11.7
- Available colours: Mist, Slate, Ocean, Olive, Mango

Product	Ref No.
PATR35M (Mist)	9600028785
PATR35S (Slate)	9600028788
PATR35O (Ocean)	9600028791
PATR35OO (Olive)	9600028793
PATR35MS (Mango)	9600028795



DOMETIC PATROL 55

- Capacity: 43 cans / 54.3 l
- Dimensions W x H x D (mm): 757 x 417 x 478
- Available colours: Mist, Slate, Ocean

Product	Ref No.
PATR55M (Mist)	9600028786
PATR55S (Slate)	9600028789
PATR55O (Ocean)	9600029271

FOOD & BEVERAGE

ACCESSORIES



BRACKET

This clever bracket, which is easily fitted to Dometic Patrol and CI iceboxes, enables a variety of convenient features to be added to your icebox. Simply clip the bracket into the handle of your icebox and then insert a range of accessories, including: a bottle opener, drink holder and rod holder.

Ref No. 9108400901



DRINK HOLDER

Made from strong PBT material, the Dometic Patrol/CI drink holder is a must-have accessory for Dometic iceboxes. The Dometic Patrol/CI drink holder can be easily clipped in to the icebox bracket, ensuring a reliable and secure hold for your favourite cold drinks.

Ref No. 9108400902



ROD HOLDER

With the Dometic Patrol/CI rod holder accessory, you can enjoy a well-deserved break from a long day's fishing while ensuring your fishing rod is held securely and primed for action! The rod holder is simply inserted into the icebox bracket. Made from durable PBT material, the Dometic Patrol/CI rod holder is built to last.

Ref No. 9108400903



BOTTLE OPENER

Made from strong stainless steel, the Dometic Patrol/CI bottle opener is a must-have accessory for Dometic iceboxes. The Dometic Patrol/CI bottle opener can be easily clipped in to the icebox bracket for an easy and reliable way to open your favourite cold drinks.

Ref No. 9108400904

COOL ICE

Iceboxes in heavy duty design

Dometic iceboxes feature an extremely effective insulation system. Once filled with ice, they can keep groceries, drinks, fish, and bait fresh for several days. The new facelift models of the popular Cool Ice series are even cooler. Practical accessories like seat cushions, fishing rod holders and bottle openers make them indispensable partners for beach-goers, fishermen, and other adventurers. The modular storage system, consisting of wire baskets and dividers, help to organise food and drink neatly.



EASY LOCK AND SEAL

Lock and seal cold air inside for longer lasting ice



EASY TO CARRY

Strong carry strap makes transportation easy (WCI models only)



STRONG DROPDOWN HANDLES

Strong, ergonomic handles for easy transport



ROBUST DESIGN

Strong, seamless, food grade polyethylene construction



TIE-DOWN POINTS

Integrated tie-down points below handles

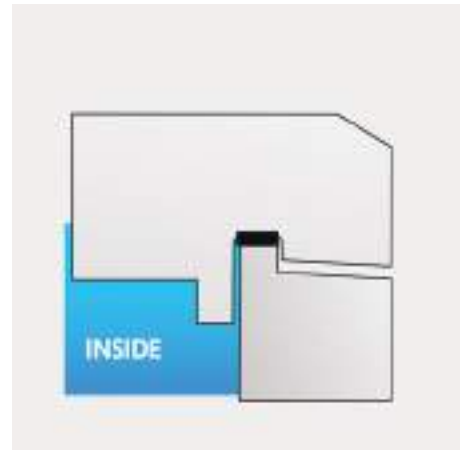

KEEP ICE FOR UP TO 10 DAYS*

The labyrinth seal prevents any heat from making its way into the interior



The Dometic Cool Ice iceboxes, was a winner of the iF Design Award, a world-renowned design prize. 63 independent experts from all over the world were impressed by the Cool Ice iceboxes ability to keep ice frozen for up to ten days and range of optional accessories*. For 65 years, the iF Design Award has been recognised as an arbiter of quality for exceptional design.

* Ice will last from 3 to 10 days depending on usage and conditions



DOMETIC COOL ICE WCI 13

Capacity of 13 l
 Dimensions W x H x D (mm): 388 x 305 x 245
 Weight (kg): 2.8
 Ref No. 9108400056



DOMETIC COOL ICE WCI 22

Capacity of 22 l
 Dimensions W x H x D (mm): 388 x 313 x 360
 Weight (kg): 4.2
 Ref No. 9108400060



DOMETIC COOL ICE WCI 33

Capacity of 33 l
 Dimensions W x H x D (mm): 420 x 440 x 360
 Weight (kg): 6.1
 Ref No. 9108400663



DOMETIC COOL ICE CI 42

Capacity of 43 l
 Dimensions W x H x D (mm): 640 x 355 x 418
 Weight (kg): 8.7
 Ref No. 9600000541



DOMETIC COOL ICE CI 55

Capacity of 56 l
 Dimensions W x H x D (mm): 570 x 432 x 515
 Weight (kg): 10.6
 Ref No. 9600000542



DOMETIC COOL ICE CI 70

Capacity of 71 l
 Dimensions W x H x D (mm): 690 x 432 x 515
 Weight (kg): 11.8
 Ref No. 9600000543



DOMETIC COOL ICE CI 85

Capacity of 87 l
 Dimensions W x H x D (mm): 840 x 432 x 525
 Weight (kg): 14
 Ref No. 9600000544



DOMETIC COOL ICE CI 85W

Capacity of 86 l
 Dimensions W x H x D (mm): 840 x 432 x 525
 Weight (kg): 14.6
 Ref No. 9600000545



DOMETIC COOL ICE CI 92L

Storage capacity of 92 l
 Dimensions W x H x D (mm): 1055 x 427 x 441
 Weight (kg): 15.3
 Ref No. 9600025763



DOMETIC COOL ICE CI 110

Capacity of 111 l
 Dimensions W x H x D (mm): 1055 x 442 x 535
 Weight (kg): 18.1
 Ref No. 9600000546



LABYRINTH SEAL
 DESIGN



LONGER
 LASTING ICE



LIGHTWEIGHT



The Dometic CIB 26 combines convenient portability with cooling reliability. Its lightweight design, weighing just 2.17 kg when empty, means the CIB 26 is easily transported using the carry handles or removable shoulder straps, which are also padded for user comfort. With 26 l of spacious storage, the CIB 26 holds 45 cans (without ice) and has room to store 2 l bottles stood upright. Contents are easily accessed thanks to the rear-hinged lid with 3-side zipper

opening, while two mesh storage pockets on the outside of the bag are ideal for storing small items like your phone or keys. Generous EPE insulation keeps ice frozen for up to 29 hours, even in warm outside temperatures. Plus, thanks to a durable polyester exterior and waterproof seams, you can take the comfort of chilled food and drink on any adventure!



DOMETIC CIB 26

Insulated cooler bag

- Durable 420D nylon liner with waterproof seams and tough 840D polyester exterior
- Generous EPE insulation for efficient cooling – keeps ice for up to 29 hours
- Integrated bottle opener hangs from the carry strap
- 26 l storage capacity fits up to 45 cans and 2 l bottles stood upright
- Padding on carry handle and shoulder strap add user comfort
- Mesh storage pockets keep small items secure and organised
- Waterproof lid zip prevents contents spilling out the bag

Dimensions W x H x D (mm): 520 x 410 x 260

Weight (kg): 2.17

Ref No. 9108400909



CI ICEBOX ACCESSORIES

Accessories for Dometic's portable icebox range

Enhance the capabilities of your Dometic CI Icebox and improve your comfort while travelling. We have accessories that optimise storage through better organisation, hold drinks or your fishing rod, and you

can even turn your icebox into a comfortable seat! Customise your icebox with accessories to suit your own needs.



DOMETIC CI-SC42 - CI-SC110

Seat cushion

This lightweight and comfortable seat cushion is suitable for use with CI 42 - CI 110 iceboxes

Product	Ref No.
CI-SC42	9108400892
CI-SC55	9108400893
CI-SC70	9108400894
CI-SC85/85W	9108400895
CI-SC110	9108400896



DOMETIC CI-DIVS

Small divider for CI 42 & CI 92L

- Manages storage in Dometic iceboxes
- Made from durable low-density polyethylene material
- Available in grey colour
- Easy to install and remove as required

Ref No. 9108400897



DOMETIC CI-DIVL

Large divider for CI 55 - CI 110

- Manages storage in Dometic iceboxes
- Made from durable low-density polyethylene material
- Available in grey colour
- Easy to install and remove as required

Ref No. 9108400898



DOMETIC CI-BSKS

Small basket for CI 42 & CI 92L

- Manages storage in Dometic iceboxes
- Made from durable powder coated steel
- Available in grey colour
- Easy to install and remove as required

Ref No. 9108400899



DOMETIC CI-BSKL

Large basket for CI 55 - CI 110

- Manages storage in Dometic iceboxes
- Made from durable powder coated steel
- Available in grey colour
- Easy to install and remove as required

Ref No. 9108400900



DOMETIC PATROL/CI BR

Bracket for Patrol and CI iceboxes

- Suitable for use with Patrol and CI iceboxes
- Easy to install and remove as required
- Made from durable PBT material

Ref No. 9108400901



DOMETIC PATROL/CI DH

Drink holder for Patrol and CI iceboxes

- Suitable for use with Patrol and CI iceboxes
- Easy to install and remove as required
- Made from durable PBT material

Ref No. 9108400902



DOMETIC PATROL/CI RH

Rod holder for Patrol and CI iceboxes

- Suitable for use with Patrol and CI iceboxes
- Easy to install and remove as required
- Made from durable PBT material

Ref No. 9108400903



DOMETIC PATROL/CI BO

Bottle opener for Patrol and CI iceboxes

- Suitable for use with Patrol and CI iceboxes
- Easy to install and remove as required
- Made from durable stainless steel

Ref No. 9108400904



DOMETIC CI-FK

Fixing kit for CI iceboxes

- Suitable for use with CI iceboxes
- Heavy duty straps
- Low profile tie-down anchor points

Ref No. 9108400905

DOMETIC SPARE PARTS



12 V CABLE

CF 25/35/40/50/50DZ /60
80-T2-2000AG
RefNo. 9108400557



12 V CABLE

CF 18 only
80-T2-2000AI
RefNo. 9108400558



12 V CABLE

Suits CF 80/80DZ/110
80-T2-1500AG1
RefNo. 9108400559



12 V CABLE

12 V CABLE
For thermoelectric models
80-T1-2800AA
RefNo. 9108400568



12 V CABLE

Suits CFX28, CFX3
35/45/55/55IM/75DZ,
CFX35W-75DZW
RefNo. 4450016808



12 V CABLE

Suits CFX
95DZ2/95DZW
RefNo. 4450016805



12 V CABLE

Suits CFX3 95DZ
RefNo. 4450021339



CHARGE CABLE

Suits RAPS 36/44
80-T2-1500JL
RefNo. 9108400562



240 V CABLE

Suits CFX & CF range
38-AU-2000B4
RefNo. 9108400560



240 V CABLE

For thermoelectric models
38-AU-2000B1
RefNo. 9108400569

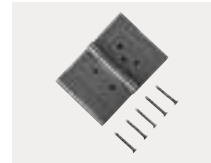

HINGE ASSEMBLY

Suits CF 80/80DZ/110
028-HINGEASA
RefNo. 9108400561



LATCH ASSEMBLY

Suits CF 80/80DZ/110
028LOCKASA
RefNo. 9108400563



LID LANYARD

Suits CF 50/50DZ/60
005NYLONASA
RefNo. 9108400564



LID LANYARD

Suits CF 80/80DZ/110
028NYLONASA
RefNo. 9108400565

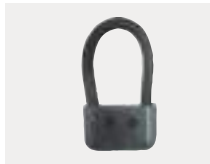

LATCH BUNGEE

WCI Icebox, pair
WCI-2001
RefNo. 9108400465



LATCH FRONT

WCI Icebox, pair
WCI-2002
RefNo. 9108400466



BUNG

Suits WCI & CI icebox range
CI-007
RefNo. 9600008929



LATCH

Suits CI icebox range,
pair # CI-001
RefNo. 9600016477



NEW

1 YEAR
WARRANTY

THIRST FOR ADVENTURE



The robust construction of Dometic drinkware is ideal for use in the outdoors. Convenient to clean and comfortable to use, the drinkware can also be used for hot and cold drinks. So whether you need refreshment while hiking in blissful isolation, or seek warmth on a cold winter morning, fuel your body with the liquid comfort it needs.



DOMETIC DRINKWARE

Dometic insulated vacuum sealed bottles ensure your cold or hot drinks maintain their temperature while you're on the move. The stainless steel used in the bottle have been carefully selected to ensure its longevity, easy cleaning and a high level of hygiene. Leak-proof, dishwasher safe and BPA Free.

Dometic insulated vacuum sealed thermo tumbler keeps drinks at the perfect temperature. Made from robust stainless steel for active lifestyles, the plastic lid has a splash resistant press-on function to avoid big spills. The lid also comes with a removable gasket for easy cleaning. Splash proof, dishwasher safe and BPA Free.

KEY BENEFITS

- Fits all standard cup holders
- Double wall insulation allows the bottles to keep drinks hot for 12 h or cold for 24 h, and allows tumblers to keep drinks hot for 6 h or cold for 12 h
- Durable construction with comfortable, ergonomic design
- BPA free
- Dishwasher safe



FOOD & BEVERAGE



DURABLE

Stainless steel body is robust and provides a comfortable drinking experience



DISHWASHER SAFE

Cleaned easily in the dishwasher and ready for your next adventure



HOT OR COLD

Double wall insulation keeps drinks hot or cold



DRINKWARE

Fuel in your hands



DOMETIC THERMO TUMBLER 320

- Capacity: 320 ml
- Fits all standard cup holders
- Double wall insulation keeps drinks hot for 6 h or cold for 12 h
- Durable construction with comfortable, ergonomic design
- BPA free
- Dishwasher safe

Product	Ref No.
TMBR32M (Moss)	9600028763
TMBR32O (Ore)	9600028764
TMBR32MS (Mango)	9600028766



DOMETIC THERMO TUMBLER 600

- Capacity: 600 ml
- Fits all standard cup holders
- Double wall insulation keeps drinks hot for 6 h or cold for 12 h
- Durable construction with comfortable, ergonomic design
- BPA free
- Dishwasher safe

Product	Ref No.
TMBR60M (Moss)	9600028767
TMBR60O (Ore)	9600028768
TMBR60MS (Mango)	9600028770





DOMETIC THERMO BOTTLE 480

- Capacity: 480 ml
- Fits all standard cup holders
- Double wall insulation keeps drinks hot for 12 h or cold for 24 h
- Durable construction with comfortable, ergonomic design
- BPA free
- Dishwasher safe

Product	Ref No.
THRM48M (Moss)	9600028755
THRM48O (Ore)	9600028756
THRM48MS (Mango)	9600028758



DOMETIC THERMO BOTTLE 660

- Capacity: 660 ml
- Fits all standard cup holders
- Double wall insulation keeps drinks hot for 12 h or cold for 24 h
- Durable construction with comfortable, ergonomic design
- BPA free
- Dishwasher safe

Product	Ref No.
THRM66M (Moss)	9600028759
THRM66O (Ore)	9600028760
THRM66MS (Mango)	9600028762



/ REFRIGERATORS

REFRIGE





RATORS

REFRIGERATORS



COOLMATIC CRX SERIES COOLER THAN EVER

The CRX Series of refrigerator is a veritable chameleon. It's a fridge, it's a fridge-freezer and it's a freezer. This patented invention is down to the removable freezer compartment and smart electronics that regulate the compressor speed, simultaneously saving energy. The freezer compartment can simply be pulled out to make a larger fridge or short-term freezer and the desired temperature manually set. (CRX 110 and 140 does not include removable freezer compartment).

- Variable Motor Speed Optimisation ensures excellent energy efficiency
- CFC-free polyurethane foam provides excellent insulation
- Fully hermetic compressor with integrated control electronics
- Ambient temperature controlled fan speed to reduce noise



ADJUSTABLE SHELVES

Easily change the height of the shelves to suit any size bottle



TWO-IN-ONE

The fridge's control panel also has an integrated light



ORGANISED STORAGE

The fridge interior is well organised with shelves



SEPARATE STORAGE

The separate compartment is ideal for storing fresh fruit and vegetables



240 V AC



12 / 24 V DC



FRIDGE / FREEZER

DOMETIC COOLMATIC CRX 50

Compressor refrigerator, 47 l

Gross volume (l): 47

Fridge storage volume (l): 41.2

Freezer storage volume (l): 4.4

Dimensions W x H x D (mm): 380 x 534 x 500

Weight (kg): 17

Ref No. 9600028416

DOMETIC COOLMATIC CRX 65

Compressor refrigerator, 60 l

Gross volume (l): 60

Fridge storage volume (l): 50

Freezer storage volume (l): 7

Dimensions W x H x D (mm): 448 x 525 x 545

Weight (kg): 19

Ref No. 9600028417

DOMETIC COOLMATIC CRX 80

Compressor refrigerator, 81 l

Gross volume (l): 81

Fridge storage volume (l): 70.6

Freezer storage volume (l): 7.5

Dimensions W x H x D (mm): 475 x 640 x 528

Weight (kg): 21

Ref No. 9600028418

DOMETIC COOLMATIC CRX 110

Compressor refrigerator, 109 l

Gross volume (l): 109

Fridge storage volume (l): 98

Freezer storage volume (l): 9.5

Dimensions W x H x D (mm): 520 x 745 x 558

Weight (kg): 27.6

Ref No. 9600028419

DOMETIC COOLMATIC CRX 140

Compressor refrigerator, 136 l

Gross volume (l): 136

Fridge storage volume (l): 124

Freezer storage volume (l): 11

Dimensions W x H x D (mm): 525 x 812 x 620

Weight (kg): 30.6

Ref No. 9600028420

CD SERIES

The CD series of refrigeration turns a small unused space into a very usable drawer fridge

3 YEAR
WARRANTY



FOOD & BEVERAGE

DOMETIC COOLMATIC CD 20

Drawer fridge, 20 l

- Its compact design is perfect if you're low on space
- Temperature control with continuously variable thermostat improves efficiency
- Convenient access with easy-pull drawer running on roller bearing slides
- User-friendly unlocking and opening with a single movement
- Temperature range +15 °C to 0 °C
- The cooling unit can be installed up to 1.5 m away giving you flexibility of position

Gross volume (l): 20

Dimensions W x H x D (mm): 440 x 250 x 564

Weight (kg): 16.1

Ref No. 9600008369

DOMETIC COOLMATIC CD 30

Drawer fridge, 30 l

- Compact design and smart solution: the compressor can be fitted to the side of the refrigerator (left or right) and up to 1.5 m away
- Temperature control with continuously variable thermostat improves efficiency
- Convenient access with easy-pull drawer running on roller bearing slides
- User friendly unlocking and opening with a single movement
- Safe locking mechanism

Gross volume (l): 30

Dimensions W x H x D (mm): 440 x 250 x 730

Weight (kg): 19.3

Ref No. 9105330083



12 / 24 V DC

ACCESSORIES

EFM FLUSH

Dometic CoolMatic flush mount installation frame

A flush mount installation frame for various models of Dometic Coolmatic fridge: CR and CRX.



Product	Description	Ref No.
DOMETIC COOLMATIC CR-IFFM-50-N	Flush mount installation frame for CRX 50	9105306410
DOMETIC COOLMATIC CR-IFFM-65-N	Flush mount installation frame for CRX 65	9105306411
DOMETIC COOLMATIC CR-IFFM-80-N	Flush mount installation frame for CRX 80	9105306412
DOMETIC COOLMATIC CR-IFFM-110-N	Flush mount installation frame for CRX 110	9105306413
DOMETIC COOLMATIC CR-IFFM-140-N	Flush mount installation frame for CRX 140	9105306414

EST STANDARD

Dometic CoolMatic standard installation frame

A standard installation frame for various models of Dometic Coolmatic fridge: CR and CRX.



Product	Description	Ref No.
DOMETIC COOLMATIC CR-IFST-50-N	Standard installation frame for CRX 50	9105306405
DOMETIC COOLMATIC CR-IFST-65-N	Standard installation frame for CRX 65	9105306406
DOMETIC COOLMATIC CR-IFST-80-N	Standard installation frame for CRX 80	9105306407
DOMETIC COOLMATIC CR-IFST-110-N	Standard installation frame for CRX 110	9105306408
DOMETIC COOLMATIC CR-IFST-140-N	Standard installation frame for CRX 140	9105306409

/ OUTDOOR COOKING



COO

DOMETIC





KING

OUTDOOR COOKING

DOMETIC CS102

Portable gas stove



OUTDOOR COOKING

The Dometic CS102 boasts high heat output of 20,000 BTU on the stove and comes complete with a hose that suits 3/8" BSP LPG cylinders. Remembering to bring matches or a lighter is a thing of the past thanks to the clever push-button Piezo ignition, which lights the burners in a matter of seconds. Avoid interruptions with the built-

in windshields, which are constructed with strong, powder coated pressed steel and cover the back and sides of the unit from exposure to wind and dust. When no longer in use, the windshields compactly fold into the unit for easy storage. The CS102 portable gas stove is a great addition for the serious outdoor adventurer.



COOK UP A STORM

- 2 burners with a combined high heat output of 20,000 BTU
- Easy push-button Piezo ignition
- Integrated windshields double as a lid when not in use
- Robust powder coated pressed steel construction
- Folds into a compact size when not in use
- Comes ready for use with 3/8" BSP LPG suitable hose and regulator

Dimensions W x H x D (mm): 470 x 90 x 330

Weight (kg): 4.1

Fuel type: LPG

Nominal gas input (g/h): 420

Operating pressure (kPa): 100

Ref No. 9600027160



COMPACT

Folds down to a compact size for easy storage



UNINTERRUPTED COOKING

Three sided windshield protects against the elements



PIEZO IGNITION

Push button ignition lights the burners in seconds



OUTDOOR
COOKING

DOMETIC CSG103

Portable gas stove with grill

The Dometic CSG103 boasts high heat outputs of 20,000 and 3,500 BTU on the stove and grill respectively and comes complete with a hose that suits 3/8" BSP LPG cylinders. Remembering to bring matches or a lighter is a thing of the past thanks to the clever push-button Piezo ignition, which lights the burners in a matter of seconds. Avoid interruptions with the built-in windshields, which are

constructed with strong, powder coated pressed steel and cover the back and sides of the burners from exposure to wind and dust when in use. When not in use, the windshields compactly fold into the unit for easy storage. The CSG103 portable gas stove is the ultimate camp kitchen for any mobile master chef.

FOOD & BEVERAGE



SATISFY YOUR COOKING NEEDS

- 2 burners with a combined high heat output of 20,000 BTU
- Integrated grill below cooktop with heat output of 3,500 BTU
- Easy push-button Piezo ignition
- Robust powder coated pressed steel construction
- Folds into a compact size when not in use
- Removable handle and grill tray included
- Comes ready for use with 3/8" BSP LPG suitable hose and regulator

Dimensions W x H x D (mm): 490 x 170 x 315

Weight (kg): 5.6

Fuel type: LPG

Nominal gas input (g/h): 495

Operating pressure (kPa): 100

Ref No. 9600027161



BUILT FOR THE OUTDOORS

Powder-coated pressed steel shell construction



UNINTERRUPTED COOKING

Three-sided windshield protects against the elements



INTEGRATED GRILL

Simultaneous cooking and grilling

DOMETIC CSO103

Portable gas stove and oven



OUTDOOR
COOKING

Take all your home cooking comforts with you on your next outdoor adventure with the Dometic CSO103 portable gas stove and oven. The CSO103 comes with two powerful brass burners, each with a 1.5 kW heat output and a powerful oven, big enough to cook a hearty meal for the family. Once connected to gas, simply turn the gas knob to initiate the Piezo ignition and begin cooking; remembering to bring matches or a lighter is a thing of the past. Integrated windshields

protect the burners from wind and dust, ensuring a peaceful cooking process each time. Once you've finished cooking and the CSO103 has cooled down, the stove and oven are easy to clean as the cooking plate and oven racks are removable and the cooking surfaces are covered with a non-stick enamel coating. With integrated, recessed carry handles, the Dometic CSO103 is easy to carry and move around the campsite when not in use.



BECOME A MOBILE MASTER CHEF

- 2 burners and oven with a high heat output of 1.5 kW and 1 kW respectively
- Easy push-button Piezo ignition
- Integrated windshields double as a lid when not in use
- Robust powder-coated pressed steel construction
- Integrated recessed carry handles for easy transportation
- Comes ready for use with gas hose, regulator and POL connector

Dimensions W x H x D (mm): 540 x 740 x 370

Weight (kg): 16.5

Fuel type: ULPG

Nominal gas input (g/h): 297.6

Operating pressure (kPa): 2.75

Ref No. 9600027162



BUILT FOR THE OUTDOORS

Robust powder-coated pressed steel construction with integrated recessed carry handles for easy transportation



UNINTERRUPTED COOKING

Three-sided windshield protects against the elements



POWERFUL OVEN

1 kW oven with two cooking racks



OUTDOOR
COOKING

DOMETIC CPB101

Portable gas BBQ

With the Dometic CPB101 portable gas BBQ, you can enjoy home cooking comforts in even the most remote locations. The CPB101 comes with a spacious cast iron cooking surface and high dome lid for cooking more of your favourite meats and vegetables at once. Achieve barbecuing perfection with the CPB101's high heat output of 11.5 MJ/h and a built-in temperature gauge. The Dometic CPB101 is constructed from steel and is robust enough for off-road trips. Despite

this, the CPB101 remains remarkably lightweight and easy to move around the campsite. Folding, removable side tables are included for a convenient place to set your ingredients, condiments and cooking utensils and folding legs allow you to position the BBQ off the table. Once you've finished cooking, the CPB101 is easy to clean so you can focus more time on exploring the great outdoors with your friends and family.

FOOD & BEVERAGE



GRILL TO PERFECTION

- Powerful heat output of 11.5 MJ/h
- Spacious cast iron grill and hot plate
- Incredibly lightweight design ensures easy transportation
- Removable side tables for added bench space
- Built-in temperature gauge for accurate cooking
- Comes ready for use with hose and POL connector

Dimensions W x H x D (mm): 940 x 430 x 420

Weight (kg): 9.2

Fuel type: ULPG

Nominal gas input (g/h): 255

Operating pressure (kPa): 2.75

Ref No. 9600027163



BUILT-IN THERMOMETER

Achieve the perfect level of heat



SPACIOUS

High dome lid ideal for roasting



POWERFUL COOKING

Cast iron cooking grill and hot plate

SLIDE OUT KITCHEN

A REVOLUTION FOR THE OUTDOOR KITCHEN SPACE

The future of cooking outdoors



AWARD
WINNING

OUTDOOR
COOKING

Not only does the Dometic Slide Out Kitchen save valuable space, but its telescopic runners also make it quick and easy to pull-out and stow away after use. It provides all the kitchen essentials: a sink, double-side access storage, three-burner cooktop, and a chopping board. Various additional features can be added such as a bottle opener, cup and utensil holders. The kitchen's modular aluminium construction makes

it lighter, while a generous amount of built-in storage keeps dining and cooking equipment safe and secure. Easy to install on most RVs thanks to its simple three-step installation method, the Slide Out Kitchen takes cooking outdoors to new levels of convenience!



DOMETIC SMALL SLIDE OUT KITCHEN

Slide out kitchen, small

- Dedicated area for cooking, cleaning, and chopping
- Easy 3-step installation process
- Compatible with all popular access doors
- Lightweight aluminium construction
- Large dual side storage compartment
- Range of accessories available, including chopping board, and utensil holder

Dimensions W x H x D (mm): 630 x 280 x 1220

Weight (kg): 34

Ref No. 9600019015



DOMETIC SLIDE OUT KITCHEN

Slide out kitchen

- Dedicated area for cooking, cleaning, chopping and serving
- Easy 3-step installation process
- Compatible with all popular access doors
- Lightweight aluminium construction
- Large dual side storage compartments
- Range of accessories available, including chopping board, and utensil holder

Dimensions W x H x D (mm): 640 x 335 x 1670

Weight (kg): 44

Ref No. 9600006441



LIGHTWEIGHT ALUMINIUM CONSTRUCTION

Easy to slide out and avoids adding unnecessary weight to the RV



DELIVERED READY-TO-INSTALL

Includes heavy-duty sliding rails and mounting brackets



GENEROUS STORAGE CAPACITY

Dual side storage compartments



The Dometic Slide Out Kitchen were a winner of the 2018 iF Design Award, a world-renowned design prize. 63 independent experts from all over the world were impressed by the Slide Out Kitchen's versatile functionality and lightweight aluminium construction. For 65 years, the iF Design Award has been recognised as an arbiter of quality for exceptional design.

KETTLE



DOMETIC PERFECT KITCHEN MCK 750

Kettle, 12 V

- A kettle designed to run off a 12 V power source
- Especially designed for mobile use
- Robust relay technology
- Automatic switch-off when boiling temperature is reached
- Boil-dry protection
- Status indication

Dimensions W x H x D (mm): 190 x 205 x 125

Weight (kg): 0.75

Ref No. 9600014796

1 YEAR
WARRANTY

ACCESSORIES



DOMETIC VACUUM SEALER

Vacuum sealer

- Airtight seal to store food and keep it fresher up to five times longer
- Easy to pack for any trip
- Close the lid until it locks into place, press the START button and seal food in seconds
- Locks in flavour, colour and nutrition

Dimensions W x H x D (mm): 380 x 87 x 151

Weight (kg): 1.41

Ref No. 9108400481



DOMETIC VACUUM SEALER ROLLS

Sealer rolls

- 8" bag size
- Airtight seal to store food and keep it fresher up to five times longer
- Easy to pack for any trip
- Locks in flavour, colour and nutrition
- Eliminate freezer burn and wasted food
- For outdoor and indoor use
- Minimise fridge and freezer space

Ref No. 9108400482



DOMETIC VACUUM SEALER ROLLS

Sealer rolls

- 11" bag size
- Airtight seal to store food and keep it fresher up to five times longer
- Easy to pack for any trip
- Locks in flavour, colour and nutrition
- Eliminate freezer burn and wasted food
- For outdoor and indoor use
- Minimise fridge and freezer space

Ref No. 9108400483



DOMETIC SKA-UH

Utensil holder

- Keep everything in one place, easily accessible during your cooking
- Utensil accessory for Dometic Slide Out Kitchen
- Made from durable PBT material which is resistant to solvents

Dimensions W x H x D (mm): 204 x 52 x 48

Ref No. 9600014077



DOMETIC SKA WIND DEFLECTOR

Wind deflector

- Designed and manufactured in Australia
- Lightweight, aluminium design allows sturdy and simple protection from the wind for the hobs
- Clips into the Slide Out Kitchen accessory bracket for quick swapping of accessories

Dimensions W x H x D (mm): 578 x 171 x 33

Ref No. 9600015515



DOMETIC SKA-AB

Adapter bracket

- Required for Utensil holder and Wind deflector
- Suits Dometic Slide Out Kitchen

Ref No. SKA-AB

1 YEAR
WARRANTY

/ GAS DETECTOR

SAFETY S





SOLUTIONS

GAS DETECTOR

DOMETIC GASCHECKER GC 100

Pocket-sized gas level indicator for gas bottles

1 YEAR
WARRANTY

Cook in comfort, shower without worry, and enjoy all your activities stress-free with the Dometic GasChecker GC 100. At just 30 g, you will be able to take this pocket-sized gas level indicator on any adventure. You can check gas levels when you think of it and at your convenience. You will always know how much gas you have wherever and whenever you want, so there's no excuse to run out of gas ever again! This hassle-

free gas level indicator lets you check gas levels instantly with the green and red LED indicator lights visually showing the cylinder's filling levels. Using two x 1.55 V batteries, this device measures with ease, using ultrasounds to determine gas levels so that you can be prepared for any adventure.

AVOID UNWANTED SURPRISES

- Small and lightweight, easy to stow away
- Provides a reliable measurement of gas level in propane and butane tanks
- Ideal for use RVing, camping, boating or at home
- For use on steel and aluminium gas bottles 200 – 350 mm in diameter
- Suitable for standard propane or butane gas bottles
- Easy to use, with green and red LED lights to indicate gas levels
- Batteries included

Dimensions W x H x D (mm): 113 x 16 x 16

Weight (kg): 0.03 kg

Batteries: 2 x 1.55 V, included

Ref No. 9103500697

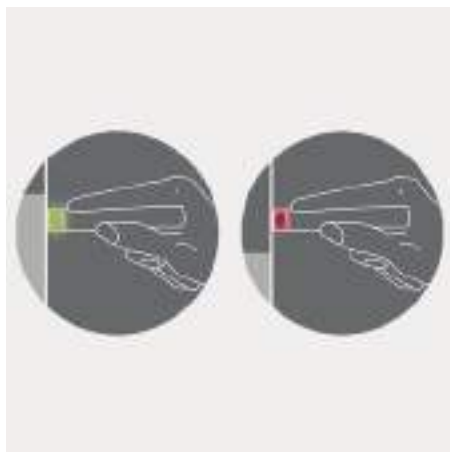

EASE YOUR MIND

Know your exact gas level with this accurate pocket-sized tester



EASY TO USE

Press firmly at a 90° angle against the gas bottle



BATTERY OPERATED

No additional power source needed means it can be used anywhere



- / GENERATOR
- / JUMP STARTER
- / CHARGERS
- / INVERTERS
- / BATTERIES
- / SOLAR PANELS
- / ACCESSORIES

ENERGY &

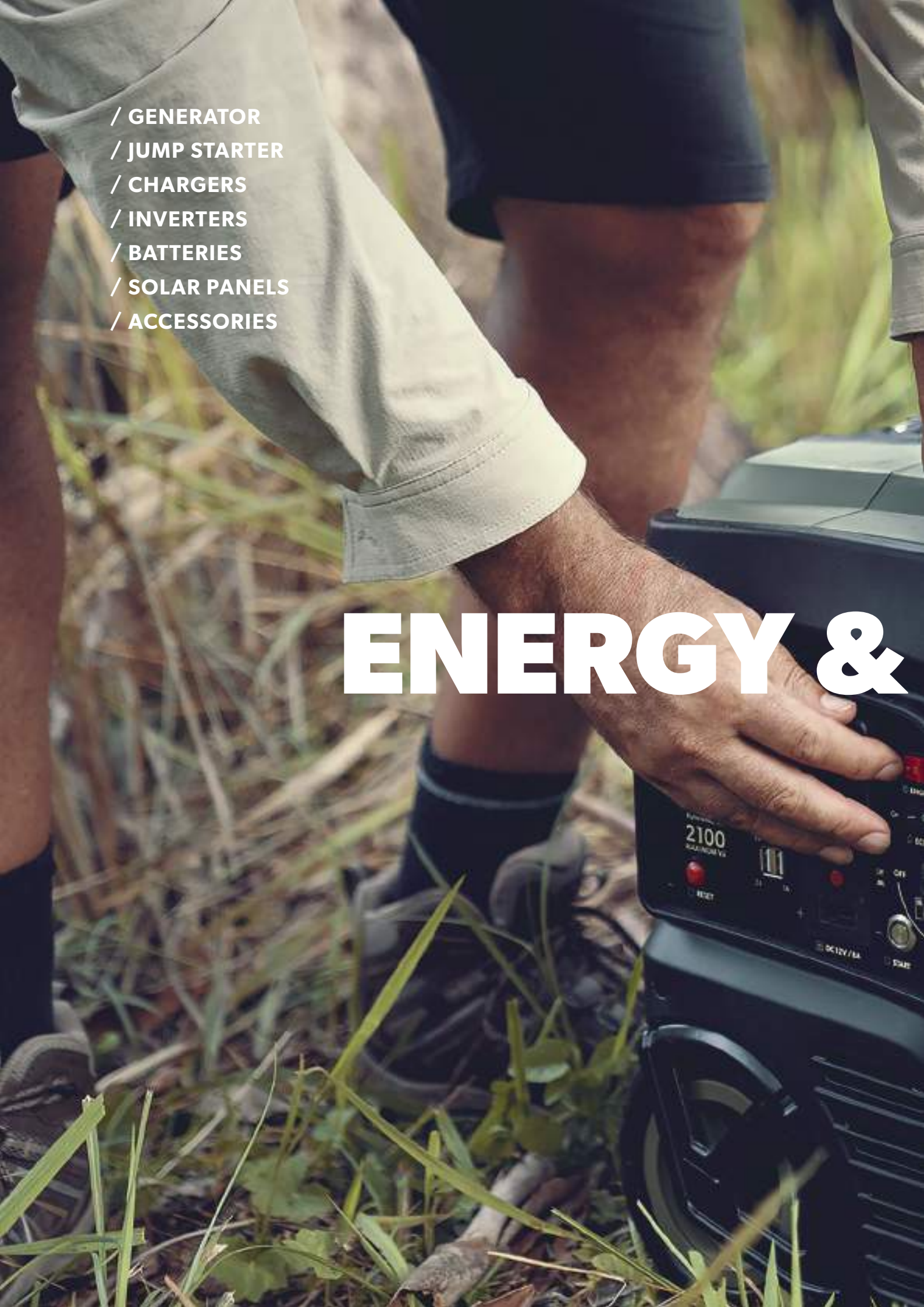



LIGHTING

GENERATOR

DOMETIC PGE121

Portable inverter generator, 2100 VA



Never be caught without a reliable source of power with the Dometic PGE121 portable inverter generator. The Dometic PGE121 boasts powerful pure sine wave inverter technology with a maximum power output of 2100 VA. Fuel efficiency is maximised and noise is minimised thanks to the clever eco-mode technology which adjusts the engine

RPM based on the connected load. You can run even the most sensitive appliances in the way that's most convenient for you, with three output types available: 12 V DC, 240 V AC, and USB. Moving the PGE121 around the campsite is easy, with built-in wheels and an extended handle ensuring that no heavy lifting is required.



STAY AS LONG AS YOU LIKE

- Powerful pure sine wave inverter technology
- High peak power output of 2100 VA and continuous output of 1800 VA
- Retractable handle and robust wheels for easy transportation
- Can be easily stored upright or on its side when the fuel is turned off
- Outputs include 2 x 240 V AC sockets, 1 x 12 V DC socket and 2 x USB sockets
- Output power can be boosted with an optional parallel connection

Dimensions W x H x D (mm): 530 x 430 x 320

Weight (kg): 26.5

Fuel tank capacity (l): 4.2

Engine oil capacity (l): 0.35

Fuel: 4-stroke Unleaded petrol

Ignition system: CDI

Ref No. 9600027157



MULTIPLE OUTPUT OPTIONS

Ability to power appliances with 12 V DC, 240 V AC or USB power



POWERFUL INVERTER



HIGH PEAK 2100 VA



12 V DC



USB OUTPUT



240 V AC OUTPUT



PUSH BUTTON START



TELESCOPIC HANDLE

Easily extend the handle to suit your height



ROBUST WHEELS

Built-in wheels for simple manoeuvring



JUMP STARTER

DOMETIC PJS118

Portable jump starter, 900 A

Achieve ultimate peace of mind on your next outdoor adventure with the Dometic PJS118 portable jump starter. Thanks to the PJS118's powerful lithium polymer technology and high peak power output, it's easy to jump start a flat 4WD or car battery of up to 4 l diesel and 6 l petrol engines and set off on an adventure; simply select your voltage using the push-button function. In addition to jump starting a flat battery, the PJS118 is also perfect for charging small USB devices

like a mobile phone when you're off the grid. The PJS118 comes with built-in protection systems, including overloading, over-discharging, overheating, reverse polarity, reverse charging, voltage stabilisation, and automatic shut-off function for a safe and secure use every time. Simply view the status of charge or voltage input on the informative LCD screen.

JUMP START YOUR ADVENTURE

- 2 x USB outputs for charging portable devices
- Built-in protection systems against overloading, over-discharge, overheating, reverse charging, and voltage stabilisation
- High peak output current of 900 A is perfect for vehicle starter batteries
- Can be easily charged with the USB-C connector
- LCD screen displays charging status, USB outputs and input voltage
- Comes packaged with charging cable, alligator clips, laptop connectors and protective case



Dimensions W x H x D (mm): 82.5 x 34 x 190.5

Weight (kg): 0.61

Start current (A): 450

Peak current (A): 900

Operating temperature range: -20 °C - +60 °C

Battery type: Lithium Polymer, Pure LiCoO2

Ref No. 9600027156

POWER & CONTROL



BUILT-IN LED TORCH

Handy LED light with SOS and strobe functions



LCD SCREEN

Informative LCD screen displays status of charge and voltage indicator



THE COMPLETE PACKAGE

Comes with cables, alligator clips, 12 V charger and storage case



BUILT-IN PROTECTION SYSTEM



240 V AC INPUT



12 V DC



900 A OUTPUT



USB OUTPUT



MULTIPLE CONNECTORS

CHARGERS

DOMETIC PBC110

Portable battery charger, 10 A

1 YEAR
WARRANTY

Stay for longer on your next outdoor adventure with the Dometic PBC110 portable battery charger, perfect for keeping common battery types at full charge, including LiFePO₄, AGM, GEL and Sealed Lead Acid batteries. A safe and reliable charge is guaranteed thanks to the PBC110's adjustable charging current output, which can be switched between 2 A, 5 A and 10 A, and its internal protection systems, which prevent reverse polarity, short-circuiting and internal

overheating. Overheating protection is achieved by the PBC110's built-in temperature sensor, which adjusts the charging curve based on the ambient temperature. The PBC110 is easy to use, with simple push-button operation to select charging current or battery type and a user-friendly LED interface that displays the charging status, power output and any errors in maintaining a charge.

NEVER BE WITHOUT A RELIABLE SOURCE OF POWER

- Adjustable charging current for maintaining a perfect charge
- Can charge common battery types, including LiFePO₄, AGM, GEL and Sealed Lead Acid batteries
- Protection systems prevent reverse polarity, short-circuiting, and internal overheating
- Temperature sensor automatically adjusts charging curve based on ambient temperature
- Wall and floor mountable

Dimensions W x H x D (mm): 205 x 52 x 90

Weight (kg): 1

Input voltage AC (V): 220 - 240

Output voltage (V): 12

Maximum output current (A): 10

Battery types: AGM, Lithium Iron Phosphate (LiFePO₄), GEL, Sealed Lead Acid

Ref No. 9600027158



LED USER INTERFACE

Displays battery charging status and power output



FLEXIBLE MOUNTING

Lightweight, portable and durable design. Can also be securely mounted to a wall.



THE COMPLETE PACKAGE

Comes packaged with a 1.8 m cable with alligator clips



BUILT-IN PROTECTION SYSTEM



220 - 240 V INPUT



ADJUSTABLE OUTPUT



12 V DC OUTPUT



WALL & FLOOR MOUNTABLE

1 YEAR
WARRANTY

PERFECTCHARGE MCA

IUOU automatic charge

Starter batteries and supply batteries are designed for different tasks. To start the engine, starter batteries must initially supply a high current level and will then serve as an energy buffer with smaller partial cycles. Supply or on-board batteries, in contrast, are discharged at lower current levels over longer periods of time and then charged again. This means they are subjected to considerably higher loads. These special

features must be considered by the charging technology to protect the batteries from damage and ensure they have a long service life. The IUOU battery chargers function using a unique six-stage charging cycle. They provide optimum charging for all gel, AGM and wet batteries, because they charge quickly and gently at the same time.



POWER & CONTROL

DOMETIC PERFECTCHARGE MCA1215

Battery charger

- 15 A charger
- Gentle charging of 12 V batteries with optimised 6-stage IUOU charging technology
- Simultaneous charging of one battery plus the starter battery
- Very compact design, lightweight and easy to install
- Sleep mode for quiet charging at half power - ideal at night or in parking spaces with low electrical circuit protection
- Comes standard with a bus interface for smooth integration in existing bus systems
- Compatible with the Dometic MPC 01 battery controller for perfect power management

Dimensions W x H x D (mm): 179 x 63 x 238
Weight (kg): 1.6

Ref No. 9108400809

DOMETIC PERFECTCHARGE MCA1225

Battery charger

- 25 A charger
- Gentle charging of 12 V batteries with optimised 6-stage IUOU charging technology
- Simultaneous charging of one battery plus the starter battery
- Very compact design, lightweight and easy to install
- Sleep mode for quiet charging at half power - ideal at night or in parking spaces with low electrical circuit protection
- Comes standard with a bus interface for smooth integration in existing bus systems
- Compatible with the Dometic MPC 01 battery controller for perfect power management

Dimensions W x H x D (mm): 179 x 63 x 238
Weight (kg): 1.7

Ref No. 9108400810

DOMETIC PERFECTCHARGE MCA1235

Battery charger

- 35 A charger
- Gentle charging of 12 V batteries with optimised 6-stage IUOU charging technology
- Simultaneous charging of one battery plus the starter battery
- Very compact design, lightweight and easy to install
- Sleep mode for quiet charging at half power - ideal at night or in parking spaces with low electrical circuit protection
- Comes standard with a bus interface for smooth integration in existing bus systems
- Compatible with the Dometic MPC 01 battery controller for perfect power management

Dimensions W x H x D (mm): 179 x 63 x 274
Weight (kg): 1.9

Ref No. 9108400811

INVERTERS



SINEPOWER

Pure sine wave inverters

Dry your hair, brew an espresso, watch your favourite movies as you would at home. Travel with all the amenities you love. Your SinePower sine wave inverter will gladly deliver the perfect voltage. Simply select the model to suit your wattage needs.



DOMETIC SINEPOWER MSI 412

Pure sine wave inverter

- 230 V AC – like at home
- Suitable for supplying sensitive devices
- Quick and easy installation
- Compact design – easy to store
- 350 W continuous output
- 700 W peak output
- Suitable for demanding appliances with high starting currents

Dimensions W x H x D (mm):

124 x 49 x 199

Weight (kg): 0.8

Ref No. 9108400851



DOMETIC SINEPOWER MSI 912

Pure sine wave inverter

- 230 V AC – like at home
- Suitable for supplying sensitive devices
- Quick and easy installation
- Compact design – easy to store
- 800 W continuous output
- 1600 W peak output
- Suitable for demanding appliances with high starting currents

Dimensions W x H x D (mm):

197.5 x 94 x 291

Weight (kg): 3

Ref No. 9108400812



DOMETIC SINEPOWER MSI 1812T

Pure sine wave inverter

- 230 V AC - like at home
- Suitable for supplying sensitive devices
- With battery saving mains priority circuit
- Compact design - easy to store
- 1600 W continuous output
- 3200 W peak output
- Suitable for demanding appliances with high starting currents

Dimensions W x H x D (mm):

197.5 x 94.3 x 406

Weight (kg): 6.5

Ref No. 9108400813

PERFECTPOWER

This compact 12 V DC to 240 V AC power inverter is ideal for travelling. It provides mobile energy for low-power devices and comes with a USB port for charging phones and other electronics in the car.



DOMETIC PERFECTPOWER

MCI-150-12

Power inverter

- Compact: the size of a drink can, it will conveniently fit in vehicle's cup holder!
- 150 W continuous output
- USB output for charging
- Overload, short circuit, high voltage and battery polarity protection system
- Low voltage shutdown
- Peak output power 250 W
- DC cigarette lighter socket

Dimensions W x H x D (mm): 21 x 21 x 173

Weight (kg): 0.49

Ref No. 9109002373



BATTERIES

DOMETIC PLB40

Portable lithium battery, 40 Ah

The Dometic PLB40 Ah Lithium Iron Phosphate battery delivers high levels of mobile power – this means that one full charge of the PLB40 allows campers to get the most out of their trip when they're living mobile. Designed for powering portable fridge/freezers and other 12 V appliances while being off-grid. Thanks to its lightweight and compact design you can enjoy true independence and travel off-grid for longer.

- Enables you to travel off-grid for longer
- Three-way charging via 12 V socket, solar panel or AC house power
- Extremely lightweight, ergonomically designed stainless steel carry-handle
- Built-in LCD screen displays: capacity, charging status and output
- Specifically designed for Dometic CFX and other powered fridge/freezers
- Powerful battery cells provide 512 Wh of energy, 40 Ah
- Can power a Dometic CFX3 45 fridge/freezer for up to 53 hours on a single charge (inside temperature +5 °C)

Dimensions W x H x D (mm): 197 x 257 x 197

Weight (kg): 7.54

Ref No. 9600009460

2 YEAR WARRANTY



For further details on awards see p.111

POWER & CONTROL



USB PORTS

Ideal for charging mobile devices



BRING TO ANY REMOTE LOCATION

Lightweight and ergonomically designed stainless steel handle



EASY TO USE

Built-in LCD screen displays charging status and output



THREE-WAY CHARGING

Via 12 V socket, solar panel or AC house power



DOMETIC COOLPOWER RAPS44

Battery pack

- Dual output sockets (12 V and Hella)
- 44 Ah deep cycle AGM battery cells
- Benefits of dual battery systems that are normally fitted permanently into cars, 4WD's, trucks and boats, except that it is portable, for added flexibility and convenience.
- Built-in charging posts for charging via 240 V DC charger (charger not included)
- 1.5 m 12 V charging lead
- Battery condition LED's/test button
- Rechargeable via solar panels

Dimensions W x H x D (mm): 230 x 245 x 227

Weight (kg): 13.5

Ref No. 9105330164

1 YEAR WARRANTY

SOLAR PANELS

1 YEAR WARRANTY



DOMETIC PORTABLE SOLAR PS120A

Portable solar panel

- Fold up easily and is compact
- Battery temperature sensor
- Adjustable feet for optimum angle to the sun
- 12 V, 10 A heavy duty regulator
- High performance monocrystalline silicon 6.63 A output
- 5 m lead with alligator clips anderson plug connector
- Lightweight at only 12.25 kg with cables and protective carry bag included

Dimensions W x H x D (mm): 534 x 754 x 70
Weight (kg): 12.25

Ref No. 9108400883



DOMETIC PORTABLE SOLAR PS180A

Portable solar panel

- Folds up easily and is compact
- Battery temperature sensor
- Three adjustable feet for optimum angle to the sun
- 12 V, 20 A heavy-duty regulator
- High performance monocrystalline silicon 9.95 A output
- 5 m lead with alligator clips anderson plug connector
- Lightweight at only 17 kg with cables and protective carry bag included

Dimensions W x H x D (mm): 538 x 758 x 115
Weight (kg): 17

Ref No. 9108400917



NEW

DOMETIC RTS160

Solar panel

- Easy to install with mounting brackets
- Withstands extreme conditions including strong wind and snow
- Strong yet lightweight aluminium frame
- Integrated with two bypass diodes to prevent cell damage from overheating
- Efficient monocrystalline silicon cells
- Topped with durable tempered glass
- IP65 junction box protects against dust and water

Dimensions W x H x D (mm): 1480 x 35 x 670
Weight (kg): 10.5

Ref No. 9600028740

ACCESSORIES

1 YEAR WARRANTY



DOMETIC COOLPOWER RAPS72 KIT

Battery cradle

- Fits two RAPS battery kits
- Sturdy powder coated cradle
- Connection lead included

Dimensions W x H x D (mm):
232.2 x 215.2 x 450.1

Weight (kg): 1.04

Ref No. 9105303701



DOMETIC SC1230

30 A solar charge controller

- 3 stage intelligent PWM solar charging
- Twin USB ports
- Low voltage disconnect
- Suitable for use with a range of battery types
- Informative backlight LCD display
- Operating temperature range of -25°C - +55°C
- Multiple load control modes

Dimensions W x H x D (mm): 181 x 100.9 x 59.8
Weight (kg): 0.55

Ref No. 9600005819



150 mm

300 mm

DOMETIC BK-150 MM DOMETIC BK-300 MM

Bracket

- Made from durable materials
- Easy to install to the rooftop of RVs
- Allows airflow to circulate under the solar panel

Ref No. 9600005820 (150 mm)

Ref No. 9600006224 (300 mm)



ACCESSORIES

ELECTRONICS

Accessories for fridge/freezers and refrigerators

No need to accept any restrictions in the use of your cooling box, even if you have a simple or older make. CoolPower accessories give you plenty of flexibility. You can run a 12 V device from a 24 V battery, or from a mains supply in your holiday home. You can also connect a clever device to prevent excessive battery drainage.



DOMETIC COOLPOWER MPS-50

Power adapter

240 V AC to 12 V DC rectifier adapter for problem free connection to 110–240 V mains systems. Suitable for Dometic compressor CD and CU models. Comes with switch mode for automatic priority of mains operation and integrated cigarette lighter socket.

- Adapter for problem free connection to 110–240 V
- Suitable for Dometic compressor CD and CU models
- Includes switch mode for automatic priority of mains operation

Dimensions W x H x D (mm): 120 x 70 x 200

Weight (kg): 1

Ref No. 9109002476



DOMETIC COOLPOWER EPS-817

Power adapter

This rectifier adapter converts 240 V AC to 12 V DC power. Ideal for the connection of listed DC compressor driven fridges and freezers. Suitable for all other 12 V thermoelectric coolers or as a universal power unit via the vehicle's integrated cigarette lighter socket.

- Maximum power consumption of 72 W
- Ideal for use at home, in a hotel, or on a campsite
- Suitable for CF, CDF, MDC fridge/freezer models

Dimensions W x H x D (mm): 115 x 64 x 170

Weight (kg): 0.6

Ref No. 9109002086

POWER & CONTROL

AWARDS



The Dometic PLB40 portable lithium battery pack, was a winner of the Good Design Award for Excellence in Design and Innovation. Judges awarded the PLB40 portable lithium battery pack as a winner thanks to its ability to meet criteria for Good Design, Design Innovation and Design Impact.



The Dometic PLB40 portable lithium battery pack, was a winner of the iF Design Award, a world-renowned design prize. 67 independent experts from all over the world were impressed by the PLB40 portable lithium battery pack's powerful Lithium Iron Phosphate battery cells and lightweight, portable design. For 66 years, the iF Design Award has been recognised as an arbiter of quality for exceptional design.



reddot award 2019
winner

The Dometic PLB40 portable lithium battery pack, was a winner of the Red Dot Award for Outstanding Design Quality. Jurors comprising of experienced experts from different disciplines from all over the world awarded the PLB40 portable lithium battery pack as a winner thanks to its performance and stability that characterise this-well-thought-out mobile device.

/ SANITATION
/ CLEANING

HYGIENE &





SANITATION

TOILETS

970 SERIES

1 YEAR
WARRANTY

The 970 series of portable toilets provide comfort, simplicity and the latest technology. When on the move, people wish for the comforts of home and the 970 Series of portable toilets provides just that. The powerful touch-button flush technology sets this toilet range miles apart from their competitors as no pumping or batteries are required. They are available in two sizes with an adult-sized seat comfortable beyond words.



DOMETIC 972

Portable toilet

- High-strength ABS construction withstands harsh environments; smooth, easy-to-clean finish
- Prismatic tank level indicator allows easy tank level monitoring
- Push-button flush clears bowl instantly
- Full-size seat for comfort; latching lid for security

Dimensions W x H x D (mm): 334 x 318 x 387

Weight (kg): 5.44

Ref No. 9108552682



DOMETIC 976

Portable toilet

- High-strength ABS construction withstands harsh environments; smooth, easy-to-clean finish
- Prismatic tank level indicator allows easy tank level monitoring
- Push-button flush clears bowl instantly
- Full-size seat for comfort; latching lid for security

Dimensions W x H x D (mm): 334 x 387 x 387

Weight (kg): 6.35

Ref No. 9108552688



LESS PUMP

This effective system requires less pump action

PUSH BUTTON OPERATION

A simple push button operation

LESS MESS

Less mess due to an extra-long pivoting discharge spout



CLEANING

ADDITIVES & CONSUMABLES

Dometic provides a complete line of innovative products to help keep your sanitation systems clean and comfortable. These include eco-friendly tabs and fluid additives for holding and flushing tanks, multi-purpose cleaners and much more.



DOMETIC POWERCARE TABS

Sanitation additive

- No spills or mess
- The dose is pre-measured so no possible overdosing and waste
- Easy storage in a handy tub
- Suitable for all portable and cassette toilets
- Fast breakdown of waste without the build-up of unpleasant gas or odours
- Lighter in weight and less cumbersome than liquids
- Ready to use tabs in a soluble film

Ref No. 9600000125



DOMETIC GREENCARE TABS

Sanitation additive

- An environmentally friendly toilet tab that doesn't cost the earth
- The dose is pre-measured – preventing overdose and waste
- No spills or mess
- Suitable for all portable and cassette toilets
- Fast breakdown of waste without the build-up of unpleasant gas or odours
- Ready to use tabs in a soluble film
- Lighter in weight and less cumbersome than liquids

Ref No. 9600000133



DOMETIC EXTRA CARE PINK

Sanitation additive

- Provides a micro-thin protective layer against stains
- Protects the workings of your toilet to ensure a smoother flush
- Pleasant fragrance from an integrated deodoriser
- Suitable for all portable and cassette toilets

Ref No. 9107200001



DOMETIC POWER CARE BLUE

Sanitation additive

- A new and improved formula where one dose can last up to four days
- Highly effective at breaking down waste and preventing nasty odours
- Works even after freezing and thawing
- Has a handy dose measuring strip on the bottle
- Has a fresh and pleasant fragrance

Ref No. 9107200002

AUSTRALIA**Dometic Australia Pty Ltd**

PO Box 1140
Clayton South VIC 3169
Tel 1300 304 220
Mail dometic.com

BELGIUM**Dometic Branch Office Belgium**

Lourdesstraat 84 B
B-8940 Geluwe
Tel +32 2 3598040
Fax +32 2 3598050
Mail info@dometic.be

DENMARK**Dometic Denmark A/S**

Nordensvej 15, Taulov
DK-7000 Fredericia
Tel +45 75585966
Fax +45 75586307
Mail info@dometic.dk

FINLAND**Dometic Finland OY**

Valimotie 15
FIN-00380 Helsinki
Tel +358 20 7413220
Fax +358 9 7593700

FRANCE**Dometic SAS**

ZA du Pré de la Dame Jeanne
B.P. 5
F-60128 Plailly
Tel +33 3 44633525
Fax +33 3 44633518
Mail lodging@dometic.fr

GERMANY & AUSTRIA**Dometic GmbH**

In der Steinwiese 16
D-57074 Siegen
Tel +49(0) 271 692 0
Fax +49(0) 271 692 302
Mail info@dometic.de

HUNGARY**Dometic Zrt. Sales Office**

H-1147 Budapest
Kerékgyártó u. 5.
Tel +36 1 468 4400
Fax +36 1 468 4401
Mail budapest@dometic.hu

ITALY**Dometic Italy S.r.l.**

Via Virgilio, 3
I-47122 Forlì (FC)
Tel +39 0543 754901
Fax +39 0543 754983
Mail vendite@dometic.it

NETHERLANDS**Dometic Benelux B.V.**

Ecustraet 3
NL-4879 NP Etten-Leur
Tel +31 76 5029000
Fax +31 76 5029019
Mail info@dometic.nl

NORWAY**Dometic Norway AS**

Elveveien 30B
3262 Larvik
Tel +47 33428450
Fax +47 33428459
Mail firmapost@dometic.no

POLAND**Dometic Poland Sp. z o.o**

ul. Puławska 435A
PL-02-801 Warszawa
Tel +48 22 414 3200
Fax +48 22 414 3201
Mail info@dometic.pl

PORTUGAL**Dometic Spain, S.L.**

Branch Office em Portugal
Rot. de São Gonçalo nº 1- Esc. 12
2775-399 Carcavelos
Tel +351 219 244 173
Fax +351 219 243 206
Mail info@dometic.pt

RUSSIA**Dometic RUS LLC**

Komsomolskaya square 6 – 1
RU-107140 Moscow
Tel +7 495 780 79 39
Fax +7 495 916 56 53
Mail info@dometic.ru

SPAIN**Dometic Spain S.L.**

Avda. Sierra del Guadarrama, 16
E-28691 Villanueva de la Cañada
Madrid
Tel +34 91 833 6089
Fax +34 900 100 245
Mail info@dometic.es

SWEDEN**Dometic Scandinavia AB**

Gustaf Melins gata 7
S-421 31 Västra Frölunda
Tel +46 31 7341100
Fax +46 31 7341101
Mail info@dometic.se

SWITZERLAND**Dometic Switzerland AG**

Riedackerstrasse 7a
CH-8153 Rümlang
Tel +41 44 8187171
Fax +41 44 8187191
Mail info@dometic.ch

MIDDLE EAST & AFRICA**Dometic Middle East FZCO**

P.O. Box 17860
S-D 6, Jebel Ali Freezone
Dubai
Tel +971 4 883 3858
Fax +971 4 883 3868
Mail info@dometic.ae

UNITED KINGDOM**Dometic UK Ltd.**

Dometic House, The Brewery,
Blandford St. Mary
Dorset DT11 9LS
Tel +44 344 626 0133
Fax +44 344 626 0143
Mail sales@dometic.co.uk

SCAN TO VIEW

We distribute our products in around 100 markets. Please ask for your contact point if not listed here, or check our website Dometic.com

Dometic is a global market leader in branded solutions for mobile living in the areas of Food & Beverage, Climate, Power & Control, Safety & Security and Hygiene & Sanitation. Dometic operates in the Americas, EMEA and Asia Pacific, providing products for use in recreational vehicles, trucks and premium cars, pleasure and workboats, and for a variety of other uses. Our motivation is to create smart and reliable products with outstanding design. We sell our products in approximately 100 countries and we have a global distribution and dealer network in place to serve the aftermarket. Dometic employs approximately 7,200 people worldwide, had net sales of more than SEK 18.5 billion (USD 2.0 billion) in 2019 and is headquartered in Stockholm, Sweden.

E & OE. Please note: Dometic may introduce modifications to products, therefore details herein are subject to change without notice. No liability is accepted for errors. Printing processes may not depict colour accurately.

Mobile living made easy.

DOMETIC **OUTDOOR**