



**ORBITVU**  
PRODUCT TELEPORTING

# ALPHASHOT XL v2

IN-HOUSE AUTOMATED PRODUCT PHOTOGRAPHY STUDIO

2D

360°



**CUT COSTS**

**INCREASE SALES**

**SPEED UP WORKFLOW**





# Be image independent

COMPLETE AUTOMATED SOLUTION FOR IN-HOUSE PRODUCT PHOTOGRAPHY.



TOYS



SPARE PARTS / INDUSTRIAL



COSMETICS



HOUSEWARES



GLASSWARE



FASHION



CONSUMER PACKAGED GOODS



See me spinning! 

[orbitvu.com/goldboot](http://orbitvu.com/goldboot)

Get perfect image of any product type.



# From shelf to online store in minutes.

## IMAGING SOLUTIONS FOR VISUAL CONTENT PRODUCTION.

A line of all-in-one photo studios that feature an automatic background removal. The product line is available in various models to serve specific product photography needs, and can take static 2D product shots, animated 360° presentations, and video.

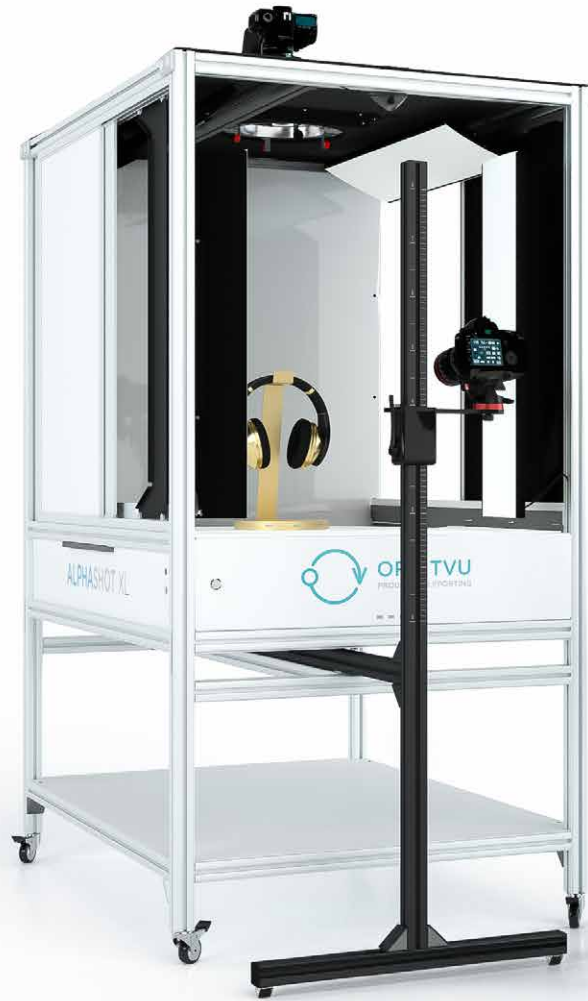

### FAST & EASY CONTENT PRODUCTION



### Efficient

- ▶ Automatic background removal
- ▶ Batch image capture and processing
- ▶ Multi-view image capture with multiple cameras at a time
- ▶ Direct image upload to your e-shop
- ▶ Web-ready photo in just a few seconds

### Easy to use

- ▶ Can be used by non-professionals
- ▶ Integrated camera and lighting control
- ▶ Automatic 360° image capture
- ▶ Predefined shooting profiles
- ▶ Live View image preview before shooting
- ▶ Multi-camera support

### Flexible

- ▶ Bags, bottles, fashion accessories, toys, electronic devices, housewares, tools and packaging are extremely well suited for Alphashot XL.
- ▶ For still images, 360°, and Video
- ▶ Compatible with Canon
- ▶ Produces images for the web, print, and marketing
- ▶ Integrated online marketing tools

## AUTOMATED IMAGING PROCESS



Automated image capture and processing workflow removes the background on the fly, reduces post-processing, and provides consistent pictures.

#### Lights & camera control

The software automatically activates camera and LED-light parameters, either via predefined or individual template settings.

#### IQ Mask & Natural Shadow

The background is removed instantly while taking a photo. Software can also detect the natural shadow and keep in the final image.

#### Post-processing

Individual post-production settings can be activated, e.g. contrast, saturation, color beautifier, sharpness, and more.

#### Auto-cropping & positioning

The object inside the image is automatically cropped. Extra margins are added and product is positioned in the picture according to your style guidelines.

#### Multi-export

Still images, 360° view, and video can be scaled and exported in one or more formats and pixel sizes. Background can even be replaced with your choice of image or color.



optional add-on

### ORBITVUSUN

ORBITVUSUN is a digital content-to-e-commerce acceleration platform as well as a set of tools to help you market your product online

#### E-COMMERCE ACCELERATION CLOUD

- ▶ Easy integration & flexible hosting plans
- ▶ E-commerce plugins included
- ▶ Daily data backup of your images
- ▶ High availability (dual data replication)
- ▶ CDN - high-speed image delivery worldwide
- ▶ Always up-to-date software and plugins



#### SELF HOSTING

- ▶ 360° HTML5 player included
- ▶ One-click upload to your e-shop with additional e-commerce plugins
- ▶ Compatible with latest web technologies



#### ONLINE MARKETING TOOLS

- ▶ Social media integrations
- ▶ 360° Orbitour - interactive product tours & hotspots
- ▶ Built in QR-code generator
- ▶ Easy Copy & Paste embed codes

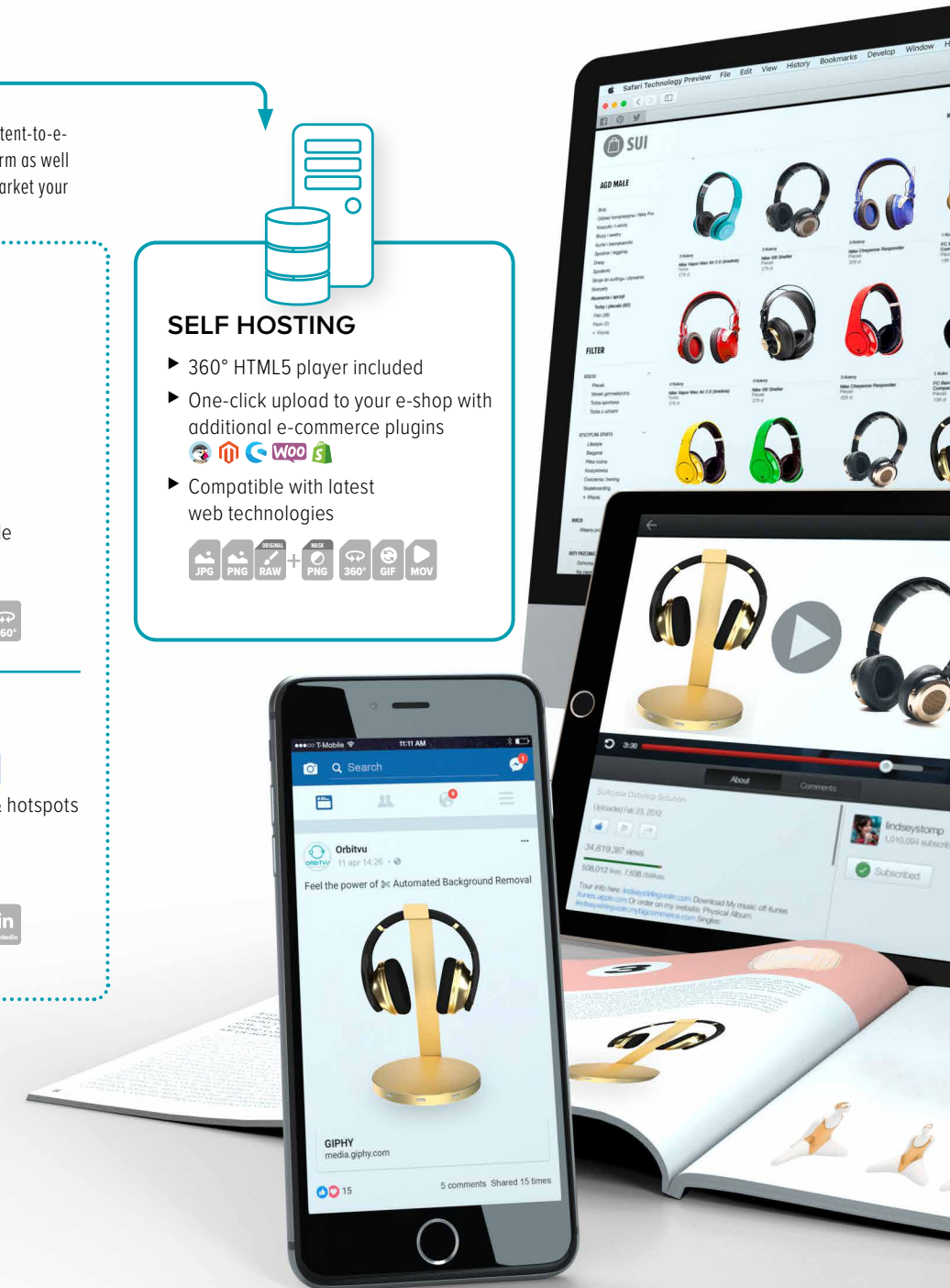

# ALPHASHOT XL v2

Alphashot XL v2 is a fully equipped photo studio at 1.3 m<sup>2</sup> footprint; cameras, lights, background and rotating platform. Everything controlled by one software, every single setting stored for repeatable results achieved effortlessly.

Packed with supreme features at the base set-up yet ready for customization and extension through many optional accessories.

## OUTSTANDING IMAGES WITH LED LIGHT

We know what the perfect light needs - high power, true colors, long lifespan, low operation cost, high density panels rather than LED strips. At your service.



PRODUCED  
IN-HOUSE

## SLIDING DOORS

Convenient access for placing products into the device with option to choose either right or left side to fit your space perfectly.

## MOTORIZED TURNTABLE

The rotating plate automatically positions your products at desired angles for packshots and also allows to create 360° presentations with a single click.

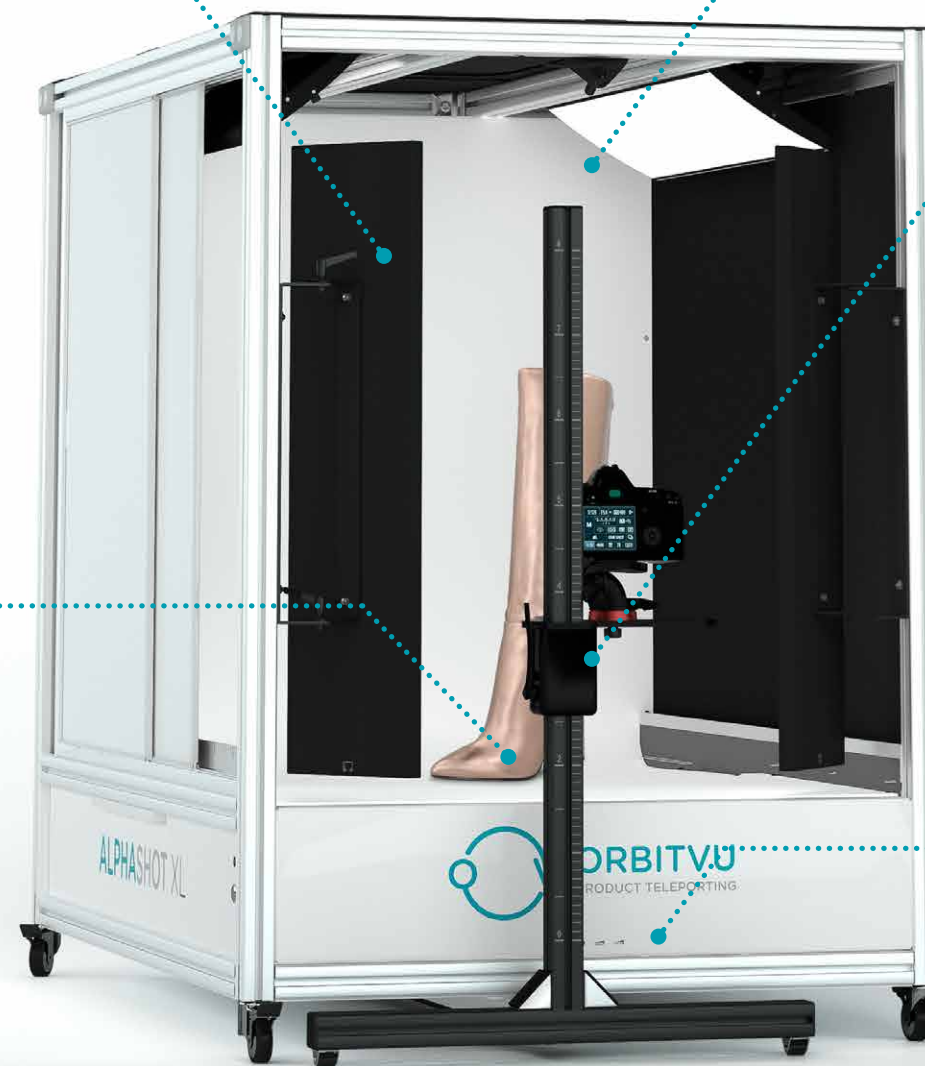
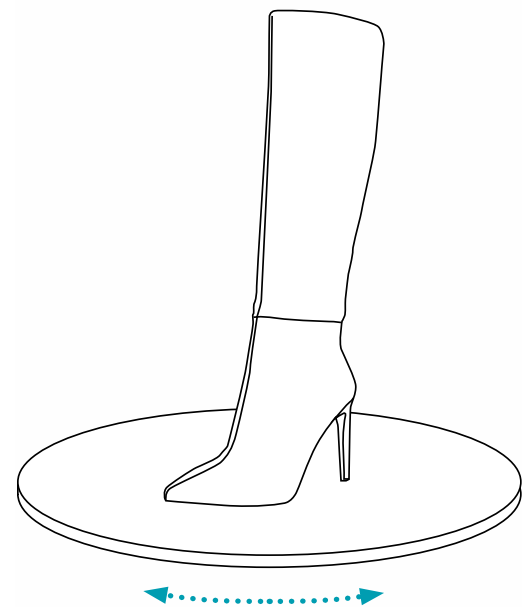

## LIGHT THE PRODUCTS NOT BACKGROUND

Our unmatched algorithm automatically removes the background so you can focus on the perfect lighting of the product. Also saves time and money for manual clipping.

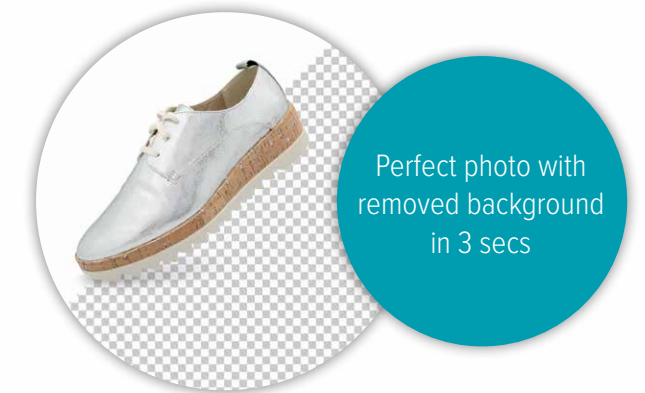

Perfect photo with removed background in 3 secs

## EASY CAMERA POSITIONING

An integrated stand saves space and always holds your camera in the center of the workspace even while shifting it forward and backward.



## PLUG AND PLAY PHOTO STUDIO

Just one cable for the camera, one cable for the computer and you're ready to go; in full control of the whole workstation through our software.





# ALPHASHOT XL PRO v2

Alphashot XL PRO v2 is tailored for the demanding users who seek even more comfort, control and precision. It features 50 cm base with a shelf, sliding lights from front to back with position scales, centering lasers or an encoder for the motorized turntable rotating plate - to name a few.

PRO gives creative freedom to professionals yet allows unskilled operators achieve professional results.

## SLIDING DOORS ON BOTH SIDES

Not only you can easily access PRO from either side, you can also change it's interior from black to white in the matter of seconds to reach even more light control.

## INCREASE EFFICIENCY WITH MULTIPLE CAMERAS

Our software can control up to five cameras simultaneously cutting production time and cost.

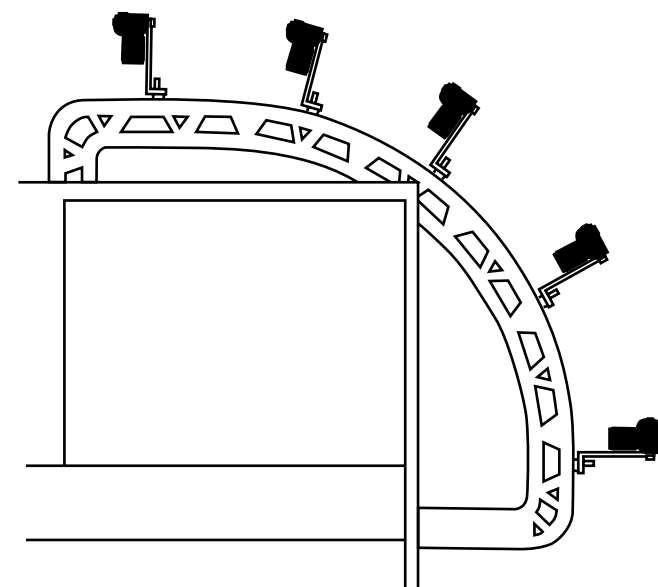

## CUSTOMIZE PRO TO YOUR WORKSTYLE

With two function buttons you can program what should the workstation do on a simple click without reaching out to your computer.



## FAST AND ACCURATE PRODUCT POSITIONING

A set of precise lasers helps you find the exact centre of the rotating plate and projects centering cross on your products.

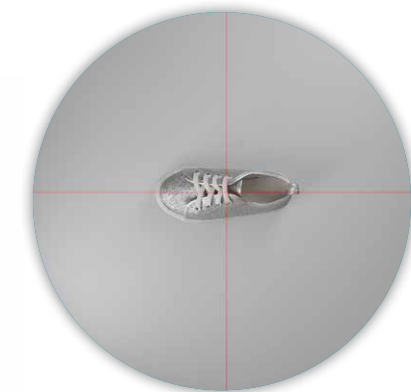

## SUPERIOR LIGHTING VERSATILITY

Independent control of six individual light panels changing their position from front to back gives you endless possibilities to match the lighting to your expectations.



Save your light set-up as a template and have it at your fingertips anytime.

## ENCODER

This smart piece of hardware avoids a need for calibration; the plate just stops at the exact position again and again.

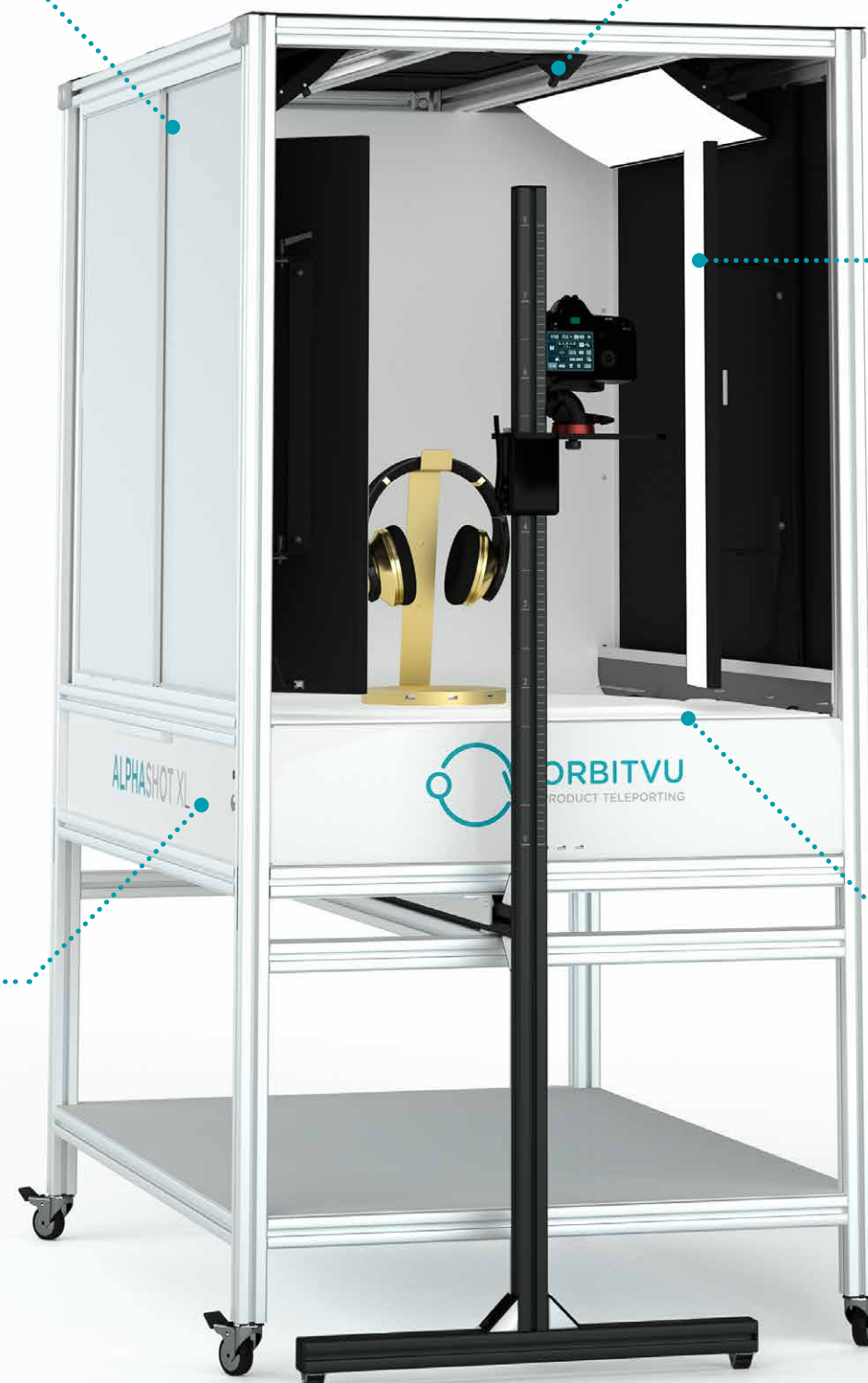

# ALPHASHOT XL WINE v2

Bottles, glassware or items that are shiny, reflective, rounded; products difficult to photograph with a need of a very specific studio set-up. We know! And we designed a workstation dedicated to conquer these troublemakers.

## AVOID UNWANTED REFLECTIONS

We painted WINE interior black to make shooting reflective objects easier by default.



white interior



black interior

## MASTER THE LIGHT

WINE comes with an anti-reflection kit AKA "light shaper" which brings the light control to the whole new level.



without anti reflection kit



with anti reflection kit

## FRONT COVER

A slick attachment that eliminates reflections, enhances lighting by black or white finished side, protects from dust and enables long exposures independent on surrounding environment.



white front cover

without front cover

## THINK OUT OF A BOX

WINE gives you four black & white sliding doors; each can be used as either reflector or shading panel.



black/black

white/black

white/white

## PAINT WITH LIGHT

Both left and right LED panels reach from bottom to top of WINE interior and can slide from front to back. If any product needs a light fine-tuning you have a great tool to do so.



## REACH HIGHER

Lift up any product from the background to achieve better light outline. And no worries about post-production: Bottle support accessory is removed by the software automatically.



without bottle support



with bottle support



# XL Family Comparison

With Alphashot XL family it's not that any model is better than the other; all three photo studios are carefully designed to serve their purpose.

Following comparison might help you decide which option is the one for you or feel free to contact our friendly worldwide sales force through [orbitvu.com/contact](http://orbitvu.com/contact).

TECHNICAL SPECIFICATIONS	XL v2 [order code 234H9]	XL PRO v2 [order code 234H11]	XL WINE v2 [order code 234H10]
Lighting LED panels	bottom, back, 2 × front, 2 × top	bottom, back, 2 × sliding front to back, 2 × top	bottom, back, 2 × sliding front to back
Motorized Turntable Diameter	75 cm		
Minimum Rotation Step	1°		
Max Load	25 kg		
Max size of photographed item [L×W×H]	50×30×70 cm		
Power Supply	100-230VAC		
Weight Net	111 kg	137 kg	120 kg
Power Consumption	max. 800W		

INCLUDED HARDWARE	XL v2 [order code 234H9]	XL PRO v2 [order code 234H11]	XL WINE v2 [order code 234H10]
Motorized Turntable	✓	✓	✓
Integrated camera stand with Manfrotto head	✓	✓	✓
Grip holder for quick camera positioning	optional	✓	✓
Elevated base with a shelf	optional	✓	optional
Product positioning kit	optional	✓	optional
Encoder	-	✓	-
Sliding doors black / white	one side	both sides	both sides
Ruler for LED panels positioning	-	✓	✓
Front textile cover black / white	optional	optional	✓
Anti-reflective kit	optional	optional	✓
Bottle support	optional	optional	✓

## INCLUDED SOFTWARE

### ORBITVU STATION SPECIFICATIONS

Camera compatibility  
Multiple camera control  
Software compatibility  
Post-production  
Background removal  
Output 360° format  
Output video format  
Output image format

Canon DSLR  
yes, up to 5 cameras  
Mac OS X or Windows  
possible via software  
automatic with IQ-Mask  
HTML5, animated GIF, MP4, MOV  
MOV, MP4, animated GIF  
png, jpeg, tiff, bmp, RAW + png mask,  
other output formats  
via external action



### ORBITVU VIEWER SPECIFICATIONS

360° technology  
Deep zoom  
Mobile ready  
Instant spin technology  
Compatibility

HTML5 player  
unlimited zoom technology  
multi-touch gestures and responsive design  
no wait time for 360° view to load  
any web browser with HTML5 support



## ALPHASHOT XL v2

[order code 234H9]

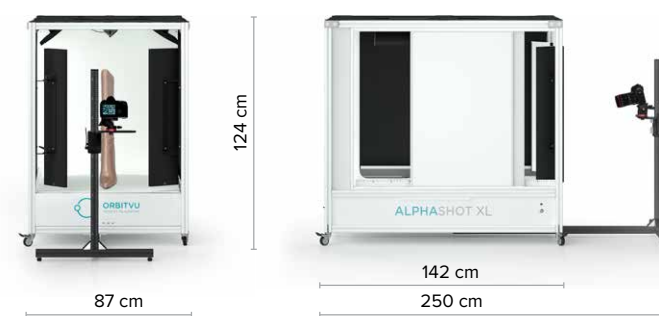

- ▶ The most affordable model
- ▶ Ready to be customised & expanded to your needs through accessories
- ▶ Gives very little room for user error; all LED panels in fixed positions

## ALPHASHOT XL PRO v2

[order code 234H11]

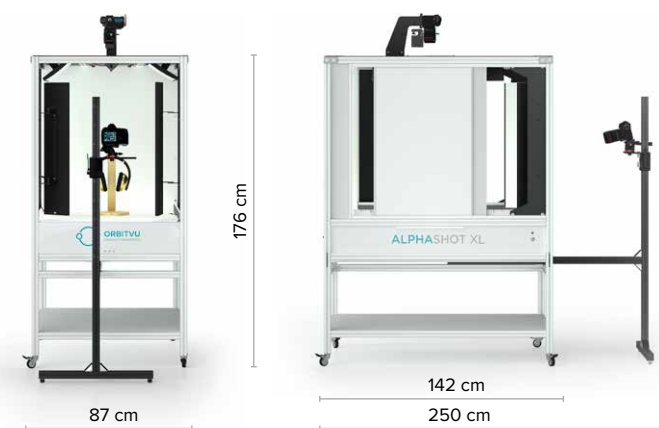

- ▶ Enhanced ergonomics; elevated base and sliding doors on both sides
- ▶ More lighting options; two LED panels sliding from the front to the back
- ▶ Maximised turntable precision with built-in encoder

## ALPHASHOT XL WINE v2

[order code 234H10]



- ▶ Black interior to handle reflections and lighting of the most difficult products
- ▶ Includes advanced lighting accessories; anti-reflection kit, bottle support and black&white front cover
- ▶ Removed top lights to avoid unwanted reflections and optimize cost (top LED panels can be purchased as optional accessory)



# Accessories overview

With over 20 optional accessories your Alphashot XL can be truly tailored to suit your products & workstyle. And you can be assured we are developing new accessories as you read these lines.

For the full list of accessories and help with choosing the best ones for you feel free to contact our friendly global sales force at [orbitvu.com/contact](http://orbitvu.com/contact).



**1. Double sided FRONT TEXTILE COVER** [order code 234A49] offers avoiding unwanted reflections when black faces inside and serves as a light reflector while white faces inside. It also seals Alphashot's inside environment to prevent dust and ambient light getting in (which allows longer exposures if necessary).

**2. A set of two PRODUCT POSITIONING KIT** [order code 234A48] projects a cross to the exact center of rotation and helps with fast products positioning. Its ultimate precision is achieved by using the finest material and machining.

**3. MOTORIZED HANGING KIT** [order code 234A40] can be synchronized with a turntable to support products from top. It can also be used as the primary rotating unit to photograph products suspended.

**4. ANTI REFLECTION KIT** [order code 234A42] not only creates seamless environment for shiny and reflective products; it also extends light shaping characteristics while moving the LED closer or further away.

**5. BOTTLE SUPPORT** [order code 234A31] lifts products from the platform which allows the light line to nicely describe product's shape from bottom to top. In addition diffusing panels of an **ANTI REFLECTION KIT** [order code 234A42] can be moved really close to the product and paint it with beautiful light gradients.

**6. MOTORIZED ZOOM** [order code 234A50] empowers you to zoom the lens in and out through the software. Not only is it comfortable but you can also store the zoom position in template to achieve better image consistency.

**7. MULTI-CAMERA RIG** [order code 234A45] is the king of productivity; holds up to five cameras in angle range 0-90° for the most efficient 3D spin photography or packshots from predefined views. Camera power supplies and USB hub are integrated in the arm structure so you can avoid the whole cable mess and connect everything to your PC using a single cable.

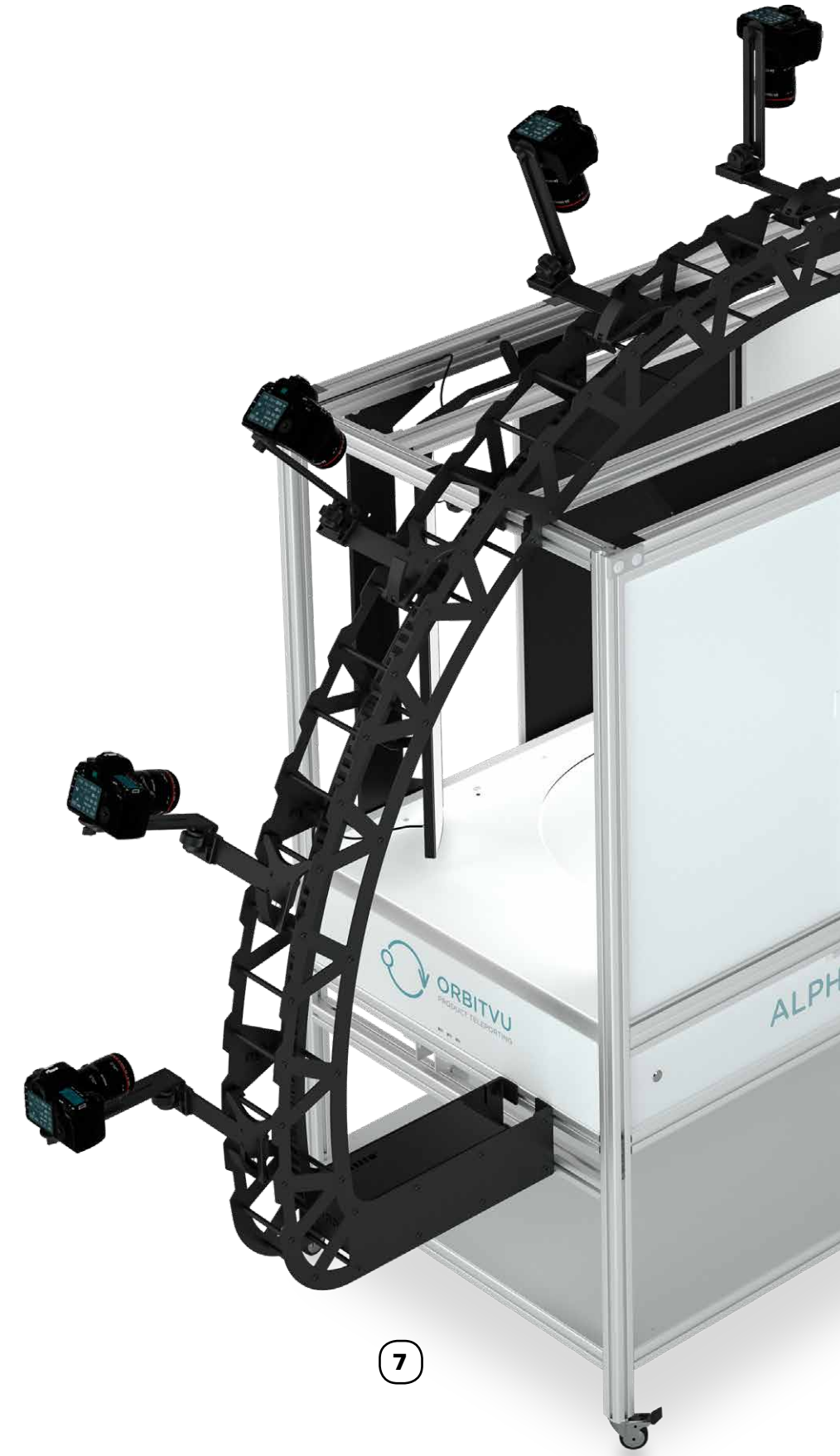





# ORBITVU

Our photography adventure started more than 20 years ago. The birth of digital photography and e-commerce created new needs and possibilities to showcase products online.

Digital content production requires consistent, good-quality images produced in a short time and at a reasonable cost. Traditional photography and manual post-production processes can yield high-quality results but are slow, complicated, and expensive.

Orbitvu takes the best from traditional photography and combines this with advanced software and hardware innovations. Our goal is to automate and optimize digital content production, delivery, and usage in our customers sales and marketing activities.

## **Our solutions will help you:**

- ▶ Save time and shorten time-to-market
- ▶ Cut costs with automated content workflow
- ▶ Improve your online product experience
- ▶ Create content for e-commerce and offline/online marketing

**With Orbitvu, your products are teleported to your customers**



[www.orbitvu.com](http://www.orbitvu.com)