

designed for  
**FLAT LAYS**



CUT COSTS | OWN THE KNOW-HOW | SPEED UP TIME TO MARKET

## ALPHATABLE & DESK

Flat lay photography taken to the next level



# Made for flat lay photography

Top-view visual content production becomes simple and fast with our flat lay photography solutions. Just place the product, preview in the live-view window, style and shoot. No advanced skills are required. Post-production and background removal is done automatically. Review the content and publish at the desired resolution, file format to a local location or directly online to your e-shop. Work quickly, save valuable time and reduce costs.





# Why Alphatable/Alphadesk?

Alphadesk and Alphatable are all-around solutions for flat lay photography. Highest quality photos of clothes, accessories, and top-view compositions can be shot and published in one streamlined process. Templates will help you to recall important settings and the versatile design of the devices will let you compose item sets freely. Get all you can from flat lay photos in your e-shop, social media or advertising - it's easier than ever!



## CONSISTENT AND REPEATABLE RESULTS

Make your shots consistent throughout the product line, or the whole shop. All settings are templated and ready to load when needed.



## BACKGROUND INSTANTLY REMOVED

No work-absorbing background removal in photo processing suites is needed. Our integrated software uses intelligent masking to remove the background in a few seconds.



## STUNNING IMAGES WITHOUT PHOTO-SKILLS

Our devices bring ease of operation and intuitive design to your work. No professional photo skills will be needed to work smoothly and efficiently.

# How it works

video  
[orbitvu.com/atworkflow](https://orbitvu.com/atworkflow)

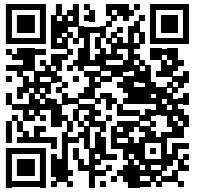

1

## SCAN A BARCODE

Start by scanning the unique product code. Our system will automatically assign it to output file names and link it with the product in your online store.

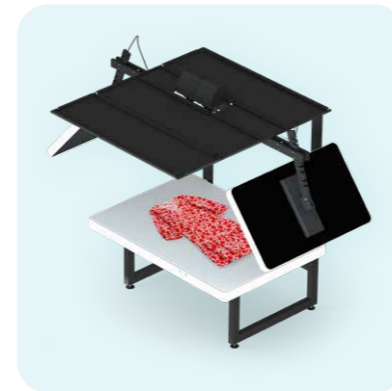

2

## PLACE THE PRODUCT AND SET THE SCENE

Leverage the benefits of supported positioning and ready-to-use templates. Place the product and choose the lighting and camera scene settings with just one click.

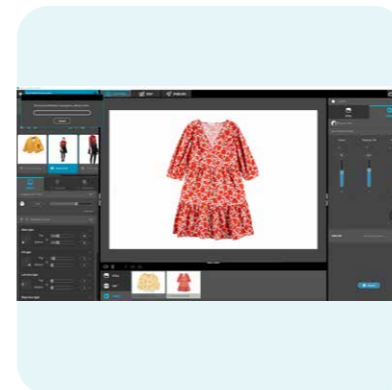

3

## CAPTURE AND EDIT

Our software will control and synchronize the camera with lighting to capture a perfect top-view image of your product. It will cut out the background from the photo on the fly and you will be able to fine-tune the output, if needed.

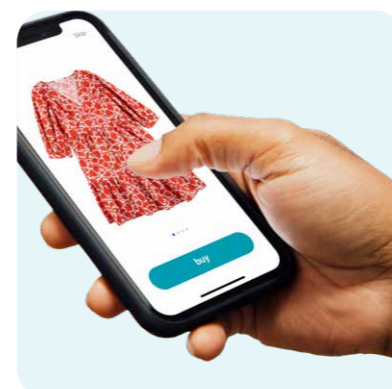

4

## PUBLISH

Export and publish online to multiple predefined locations. Save valuable time while the process runs in the background. With the e-commerce plugins and automatic SKU linking, get the product online in less than a few minutes.

# Hardware features

## 1 TOP COVER

Blocks external light from interfering with the photographed object.

## 2 POWER LIGHTING

Adjustable, high CRI LED panels for best color reproduction.

## 3 INTEGRATED CAMERA ATTACHMENT

Built into the frame structure to provide remote camera control.

## 4 INSTANT CAPTURE BUTTONS

Capture shots with just one button-press. Boost your efficiency with the fastest workflow ever.

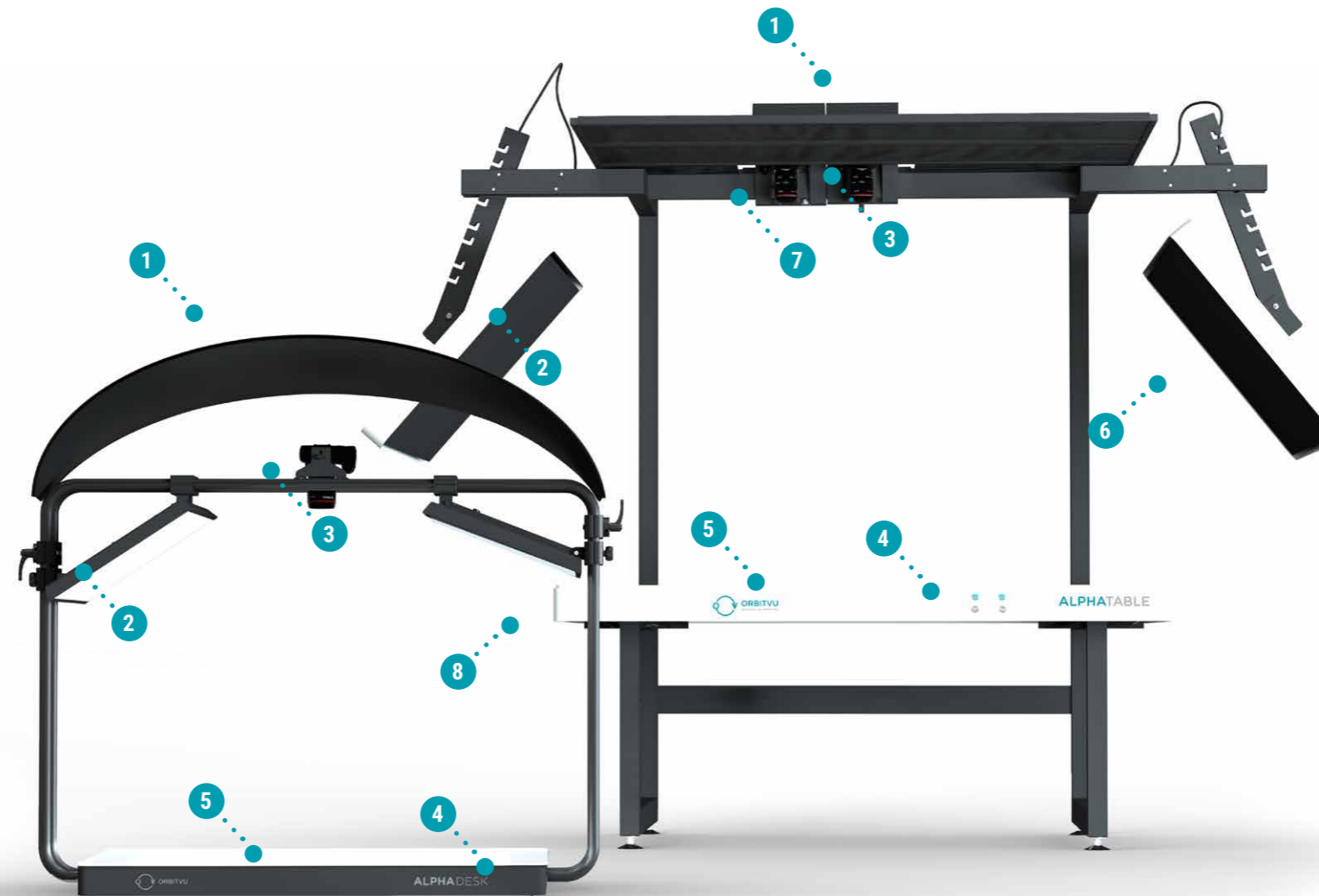

## 5 BACKLIT BASE

Lights the item evenly from the bottom and allows the Orbitvu software to cut the background.

## 6 TWO-SEGMENT LAMPS

Each segment can be individually controlled in the Orbitvu software. Prepare for more lighting flexibility.

## 7 MOTORIZED ZOOM

Enables remote user control of the lens zoom through the Orbitvu software. Zoom position can be stored in a template.

## 8 INTEGRATED CABLES

All power supply and USB cables are embedded and hidden in the construction.

# Technical specifications

## ALPHADESK [order code 240H1]

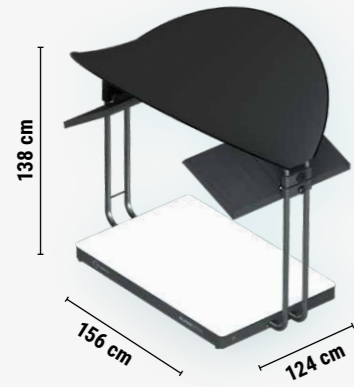

Dimensions [L x W x H]	<b>156 x 124 x 138 cm</b>
Total weight	<b>55 kg</b>
Max size of photographed objects [L x W x H]	<b>85 x 70 x 5 cm</b>
Max load	<b>10 kg</b>
Main light	<b>LED panels (2 x 190W)</b>
LED Color Rendering Index (CRI)	<b>&gt;95</b>
External power supply	<b>100-230VAC</b>
Max. power consumption	<b>665W</b>
Logistic dimensions [L x W x H]	<b>138 x 102 x 150 cm</b>
Logistic weight	<b>148 kg</b>

## ALPHATABLE [order code 236H2]

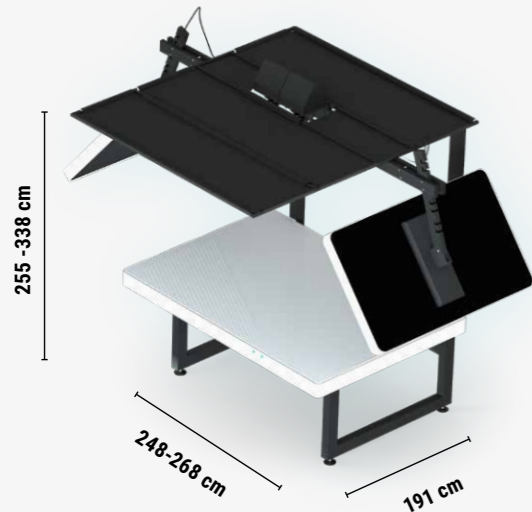

Dimensions [L x W x H]	<b>255 x 191 x 248 cm</b>
Dimensions max. [L x W x H]	<b>338 x 191 x 268 cm</b>
Total weight	<b>200 kg</b>
Max size of photographed objects [L x W x H]	<b>165 x 112 x 5 cm</b>
Max load	<b>80 kg</b>
Main light	<b>LED panels (2 x 700W)</b>
LED Color Rendering Index (CRI)	<b>&gt;95</b>
External power supply	<b>110-230VAC</b>
Max. power consumption	<b>2015W</b>
Logistic dimensions [L x W x H]	<b>278 x 144 x 168 cm</b>
Logistic weight	<b>490 kg</b>



## SOFTWARE SPECIFICATIONS

### ORBITVU STATION

Software for device control and post-production.

Camera compatibility	<b>selected Canon/Sony cameras*</b>
Multiple camera control	<b>yes, up to 2 cameras (Alphatable)</b>
Post-production	<b>possible via software</b>
Background removal	<b>automatic with IQ-Mask</b>
Output format for animations	<b>MOV, MP4, animated GIF, HTML5</b>
Output image format	<b>png, jpeg, tiff, bmp, psd, RAW + png mask, other output formats via external action</b>
Software compatibility	<b>Mac OS/ Windows</b>

### ORBITVU VIEWER

Animation/360° spin player

360° technology	<b>HTML5 player</b>
Deep zoom	<b>unlimited zoom technology</b>
Mobile ready	<b>multi-touch gestures and responsive design</b>
Compatibility	<b>any web browser with HTML5 support</b>

\* For more information, visit our compatibility page: [orbitvu.com/compatibility-guide](https://orbitvu.com/compatibility-guide)

All product-related data (including product specification and design) are subject to change without notice.



# Made for creativity

Style apparel, accessories and item compositions. Shape lighting and preview results in the live-view window. Add a background and create stunning visual content.



# About us

---

Our photography adventure started over 20 years ago. We set off just when the birth of digital photography and e-commerce created new needs and exciting possibilities to showcase products online.

Digital content production creates the need for consistent, good-quality images produced in a short time and at a reasonable cost. Traditional photography and manual post-production may yield high-quality results but stay slow, complicated, and expensive.

Orbitvu takes the best from traditional photography and combines it with advanced software and hardware innovations. We automate and optimize digital content production. We help to deliver it online and effectively share in your sales and marketing activities.

As an international leader in the automated photography market, we work for you in a team of more than 150 employees world-wide, with our own research & development and 4000 square meters of Europe-based production spaces. Our carefully perfected solutions will cover all of your workflow, improve online product experience of your customers, and effectively reduce the expenditure.

With Orbitvu, your products are teleported to your customers.

## FOLLOW US:

