

Spécifications produit

Produit Écran TFT

Modèle APT TFT [750C-Bluetooth](#)

Abbréviation [750C](#)

Client

Customer

audit

Supplier Tianjin APT Science and Technology Co., Ltd.

1001, Building 5 HuaDing, No.1 HuaKe 3 Road, Binhai hi-tech Industrial Development Zone, Tianjin, China

Tel TEL:+86 22 83715556
FAX:+86 22 83719955

Email yzhao@aptdevelop.com

1 Nom du produit

- ◇ écran TFT
- ◇ Modèle: APT TFT 750C-Bluetooth

2. Fournisseurs

- ◇ Tianjin APT Science and Technology Co., Ltd.
- ◇ Email : yzhao@aptdevelop.com apt@aptdevelop.com

3. Paramètres électriques

- ◇ 3.2pouces IPS écran
- ◇ 24V/36V/48V/52V batterie
- ◇ Courant nominal : 40mA
- ◇ Off courant sortant < 1uA
- ◇ Courant maximum sortant au contrôleur: 100mA
- ◇ Température fonction: -20~70°C, Storage temperature : -30~80°C

4. Dimensions & Matériel

- ◇ La coque du produit est en ABS, la fenêtre transparente est en acrylique de haute résistance.
- ◇ Dimensions : L110mm*L68.2mm*H68mm



5. Fonctionnalités

displays the I-bike information interface of the meter, and the MAIN interface, the navigation interface (Navi) and the more information interface (More). The meter displays the battery indicator of the phone, and the icon BLE is dark blue (connected).

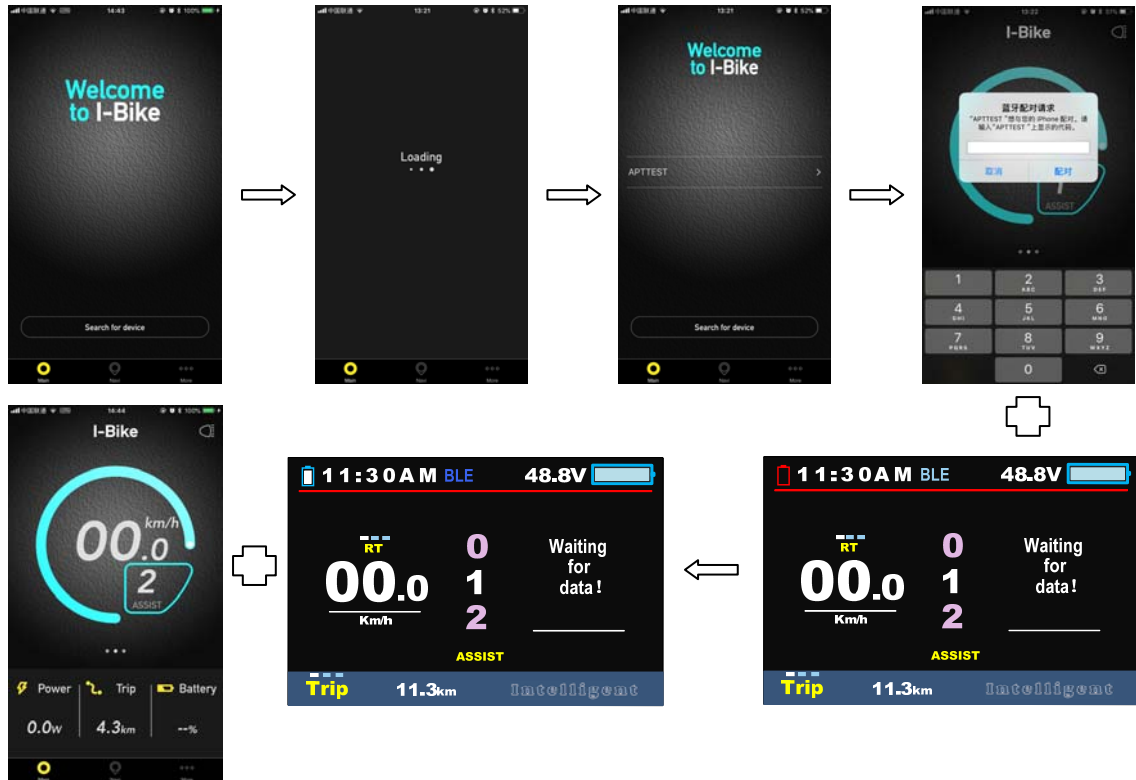

- (3) In the mobile navigation interface, enter Location and choose destination, then the mobile phone displays the map navigation path, distance and usage time information. After clicking **start**, the meter displays the navigation icon  ,  or  and distance information.

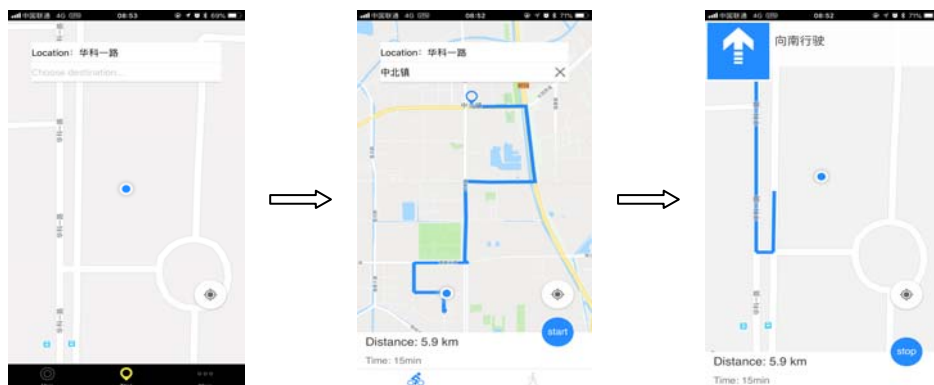



(4) Mobile phone I-bike interface display information.

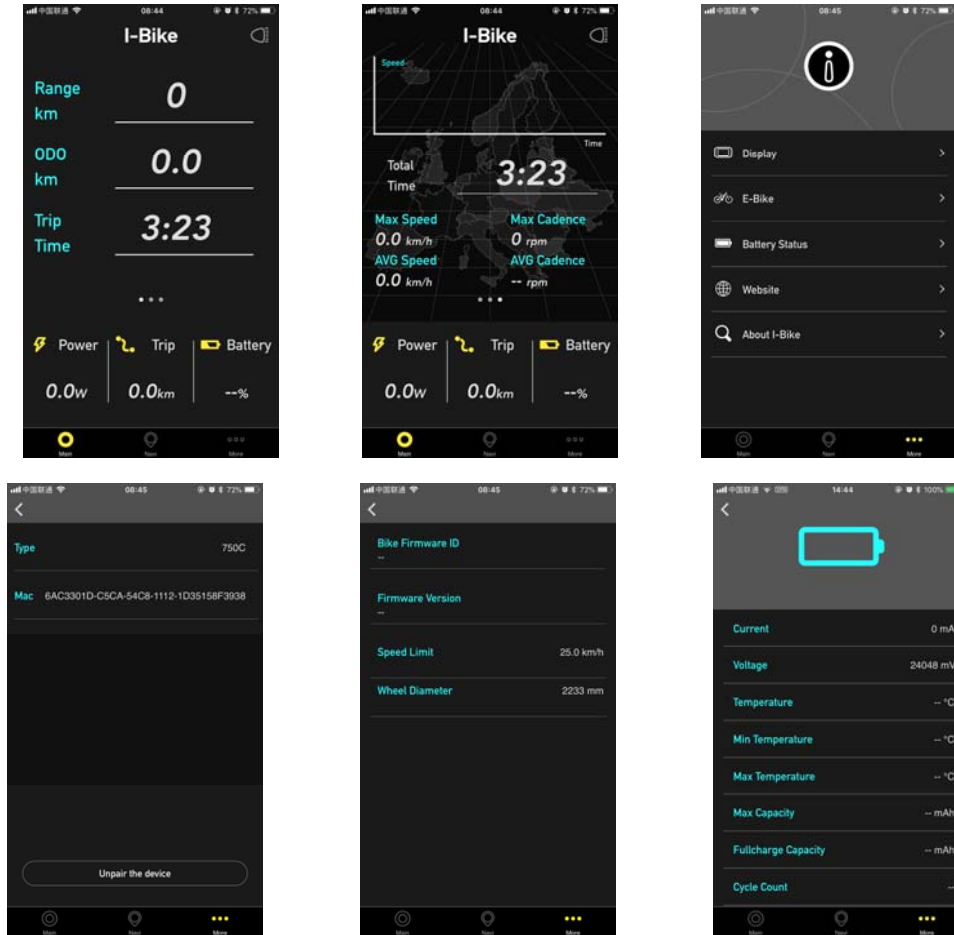

7.8 Data cleanup

Press and hold **UP** & **DOWN** buttons together for 1 second can reset several temporary data, temporary data include **AVG Speed / MAX Speed / Trip / Time**.

* These temporary data can't be erased by power off.

8. Parameter setting

Double press **MENU** button (press interval less than 0.3 second) can get into setting menus, press **POWER** button to change **Display Setting / Basic setting**, press **UP/DOWN** buttons to change the parameter setting, press **MENU** button can switch to next item. Double press

MENU button will exit from menu.

- * Display will automatically quit menu when there is no operation for 30 seconds.
- * For safety reasons, display can't get into MENU when riding.
- * Display will quit MENU when start riding.

The order of parameters are as follow.

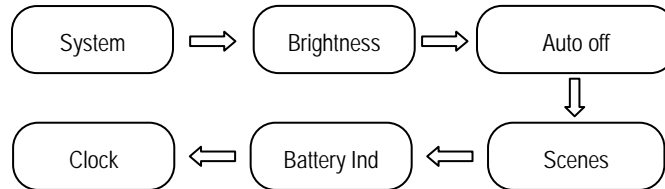

8.1 System : Press Up / Down button to switch between Metric / Imperial.

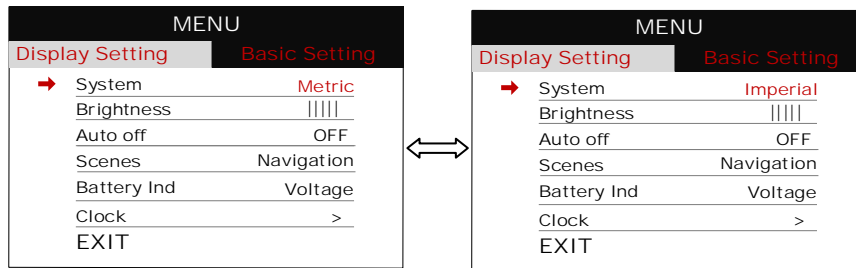

8.2 Brightness : Press Up / Down button to change the brightness of the backlight, | is darkness, ||||| is brightness. The daytime mode defaults to |||||, and the night mode defaults to ||.

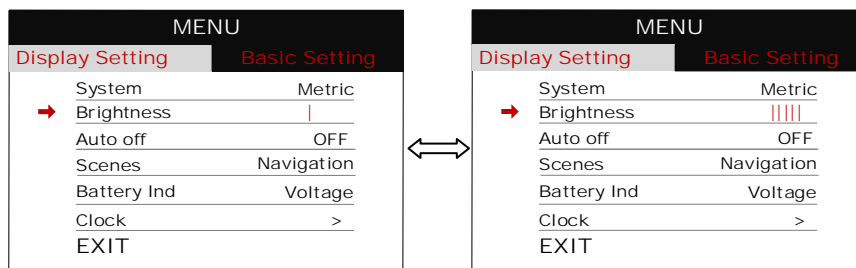

8.3 Auto off : Press UP/DOWN button to change the auto power off time, from 1 to 9 or OFF, the number represent time (minutes) to shutdown, default value is 5 minutes.

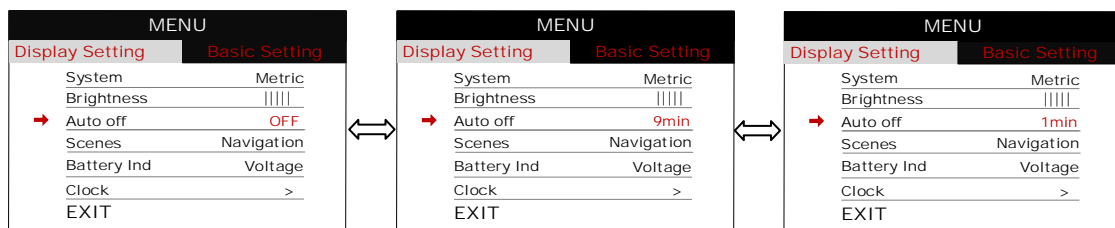

8.4 Scenes: Press UP/DOWN button to change the scenes, Navigation / M-power.

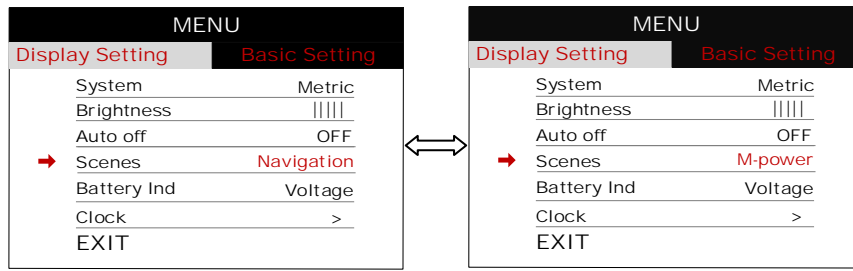

8.5 Battery Ind : Press UP/DOWN button to change the battery indicator, Voltage / Percentage / OFF.

*Accurate percentage needs communication with battery.

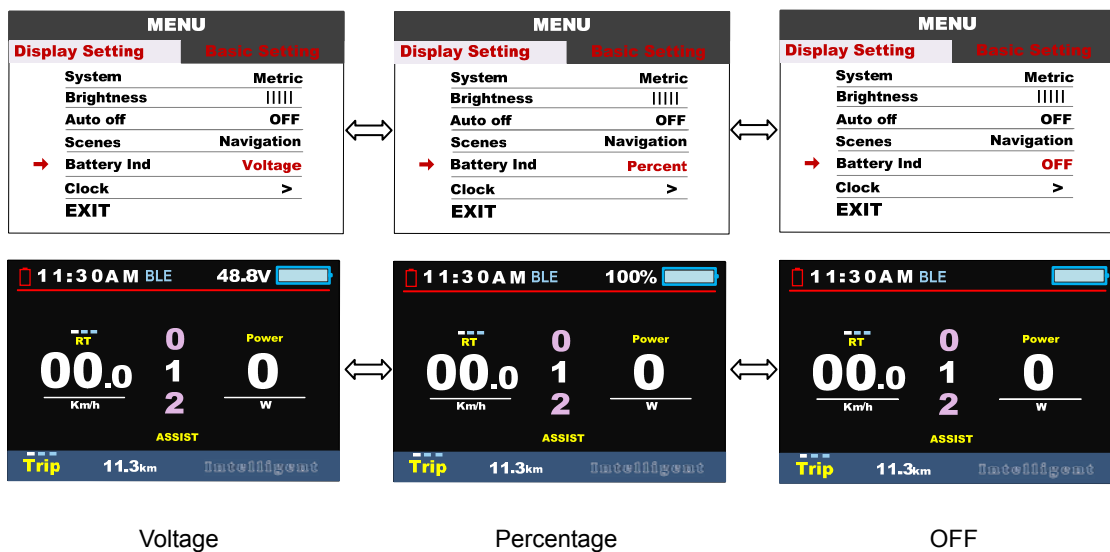

8.6 Clock : Clock setting, press **MENU** button get into the clock setting menu, press UP/DOWN button to set Year/Month/Day/Hour/Min/Sec.

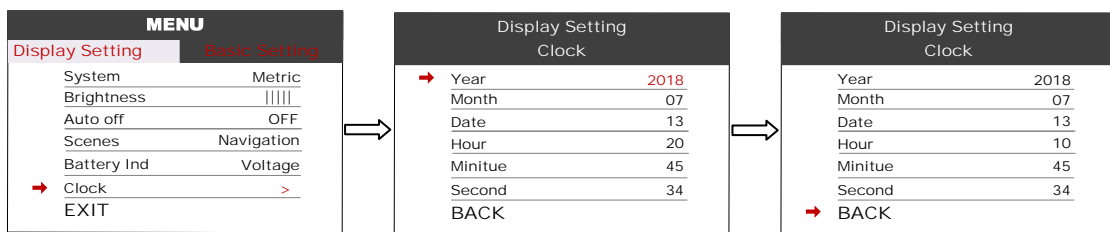

Basic Setting

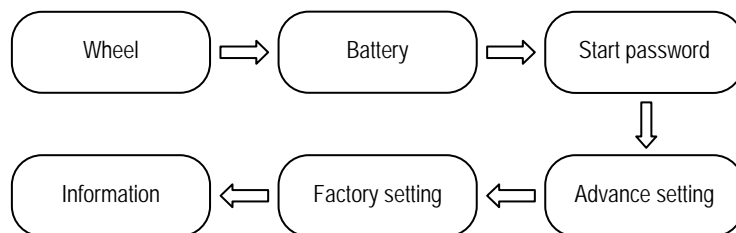

8.7 Wheel : Press UP/DOWN can change the wheel setting, optional wheel diameter is 16/18/20/22/24/26/27/27.5/28/29/30/31 inch, 51cm~255cm represent wheel circumference (this needs controller support).

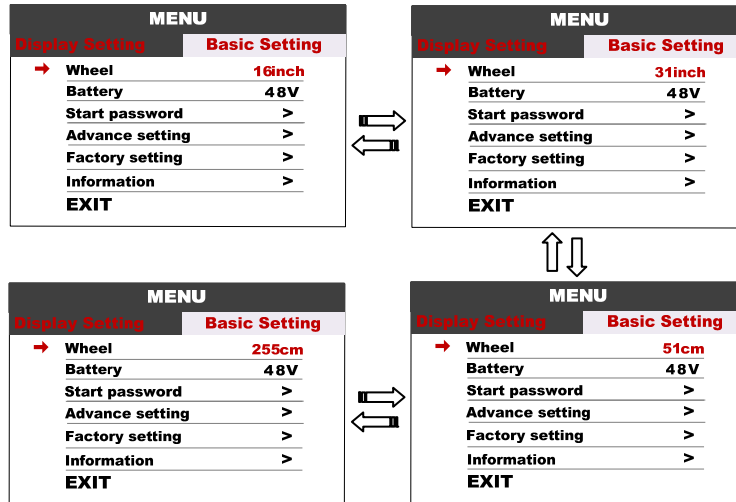

8.8 Battery : Press UP/DOWN will change battery voltage setting, optional value is 24V/36V/48V/UBE, UBE means user define value.

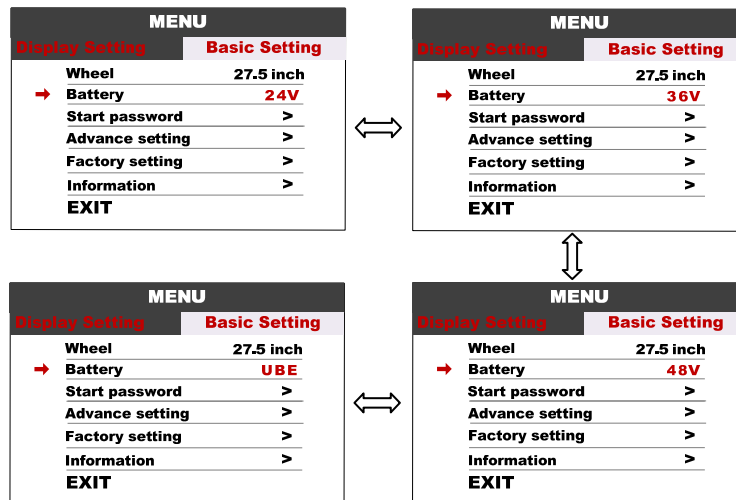

8.9 Start password : Press **MENU** button get into the password setting menu. If you had set Start input **ON**, you must input right password before power on, password is accorded to your setting.

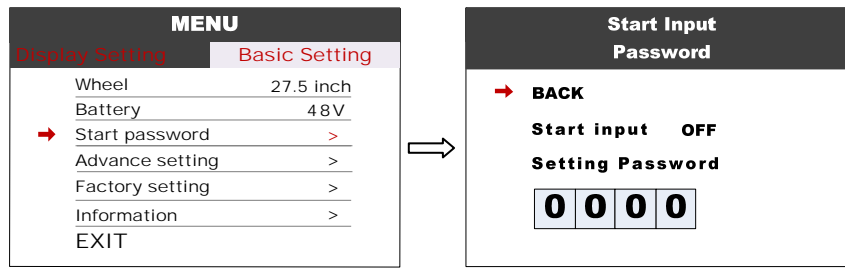

You need to input the right password before start with 30 seconds, display will power off automatically if the password was wrong three times.

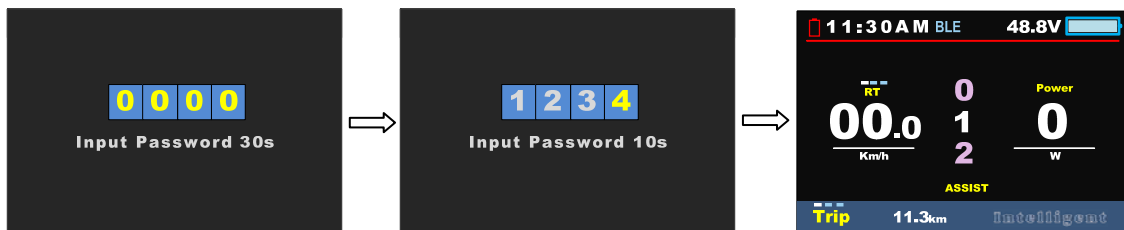

8.10 Advance setting: Press **MENU** button can get into the advance setting menu, default password is '1919'.

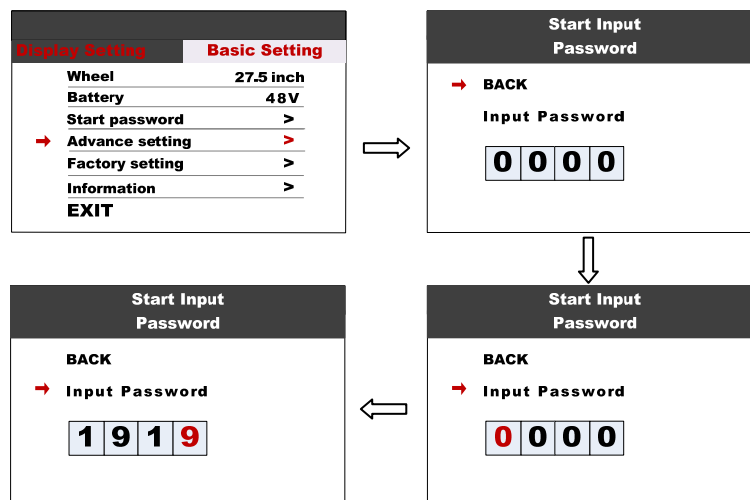

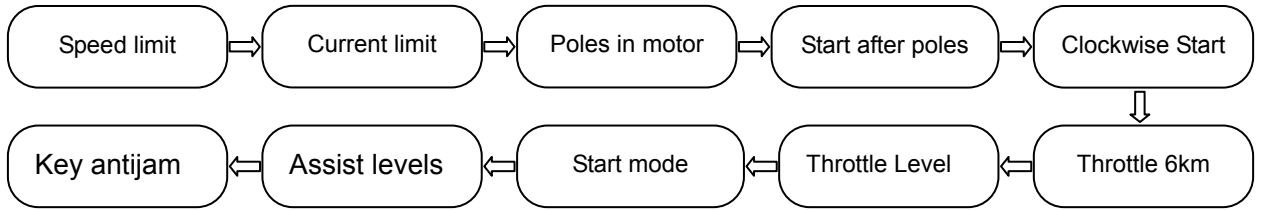

8.11 Speed limit : Press UP/DOWN will change speed limit, range 10km/h~60km/h.
Default value is 25km/h.

Advance Setting	
→ Speed limit	10km/h
Current limit	15A
Poles in motor	1
Start affter poles	3
Clockwise Start	Y
Throttle 6km	N
NEXT PAGE	
EXIT	

Advance Setting	
→ Speed limit	25km/h
Current limit	15A
Poles in motor	1
Start affter poles	3
Clockwise Start	Y
Throttle 6km	N
NEXT PAGE	
EXIT	

Advance Setting	
→ Speed limit	60km/h
Current limit	15A
Poles in motor	1
Start affter poles	3
Clockwise Start	Y
Throttle 6km	N
NEXT PAGE	
EXIT	

*Speed limit and current limit are restricted by controller and motor

8.12 Current limit : Press UP/DOWN will change current limit, range 6A~50A. Default value is 15A.

Advance Setting	
Speed limit	25km/h
→ Current limit	06A
Poles in motor	1
Start affter poles	3
Clockwise Start	Y
Throttle 6km	N
NEXT PAGE	
EXIT	

Advance Setting	
Speed limit	25km/h
→ Current limit	15A
Poles in motor	1
Start affter poles	3
Clockwise Start	Y
Throttle 6km	N
NEXT PAGE	
EXIT	

Advance Setting	
Speed limit	25km/h
→ Current limit	50A
Poles in motor	1
Start affter poles	3
Clockwise Start	Y
Throttle 6km	N
NEXT PAGE	
EXIT	

8.13 Poles in motor : Magnetic poles inside the motor, press UP/DOWN will change pole number, range 0~15.

Advance Setting	
Speed limit	25km/h
Current limit	15A
→ Poles in motor	0
Start affter poles	3
Clockwise Start	Y
Throttle 6km	N
NEXT PAGE	
EXIT	

Advance Setting	
Speed limit	25km/h
Current limit	15A
→ Poles in motor	1
Start affter poles	3
Clockwise Start	Y
Throttle 6km	N
NEXT PAGE	
EXIT	

Advance Setting	
Speed limit	25km/h
Current limit	15A
→ Poles in motor	15
Start affter poles	3
Clockwise Start	Y
Throttle 6km	N
NEXT PAGE	
EXIT	

8.14 Start after poles : How many poles (speed sensor) need to be detected by controller before starting motor. Default value is 3.

Advance Setting	
Speed limit	25km/h
Current limit	15A
Poles in motor	1
→ Start affter poles	1
Clockwise Start	Y
Throttle 6km	N
NEXT PAGE	
EXIT	

Advance Setting	
Speed limit	25km/h
Current limit	15A
Poles in motor	1
→ Start affter poles	2
Clockwise Start	Y
Throttle 6km	N
NEXT PAGE	
EXIT	

Advance Setting	
Speed limit	25km/h
Current limit	15A
Poles in motor	1
→ Start affter poles	3
Clockwise Start	Y
Throttle 6km	N
NEXT PAGE	
EXIT	

8.15 Clockwise start : This parameter represent speed sensor turn direction, default value is Y (forward).

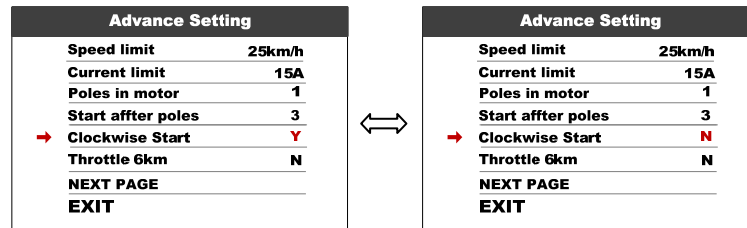

8.16 Throttle 6km : this parameter can set the throttle function, N represent max speed, Y represent 6Km.

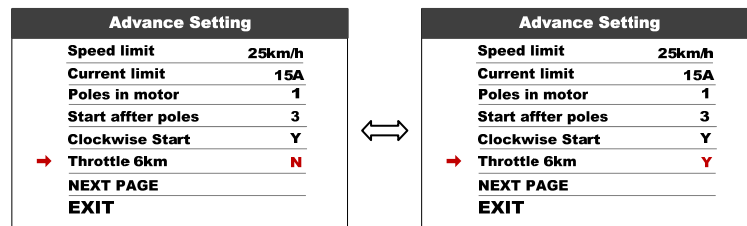

8.17 Throttle Level : This parameter is functional when Throttle 6KM set N, Press UP/DOWN will change Y/N, N represent Throttle start max speed, Y represent throttle's speed is accorded to the assist level.

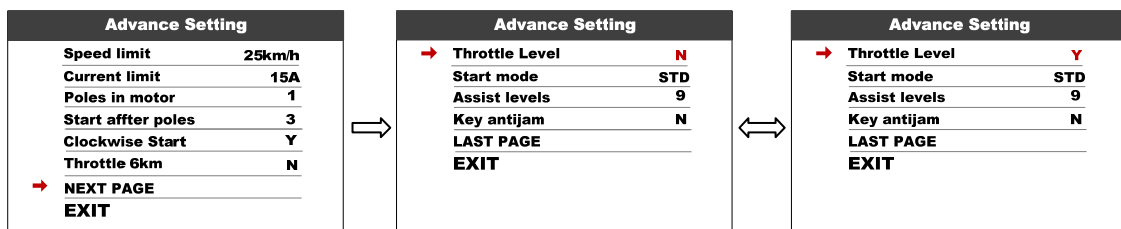

8.18 Start mode : Pow/ECO/STD represent Power/ECO/Standard, STD (default). Power mode means use maximum current when speed up, ECO mode means use minimum current.

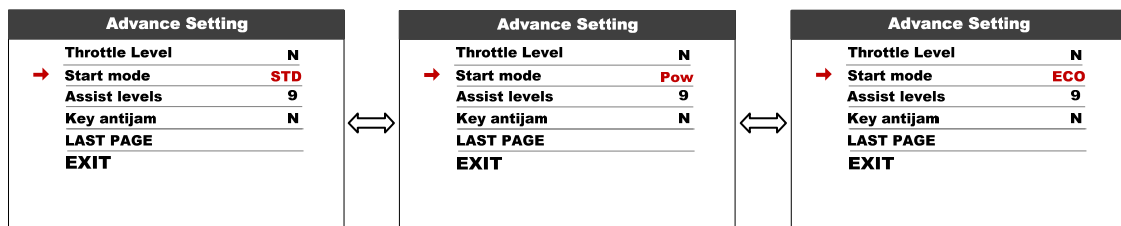

*This function is optional, may not supported by each mode.

8.19 Assist levels : This parameter can customize assist levels, options are 3/5/9/UBE, UBE represent factory default settings.

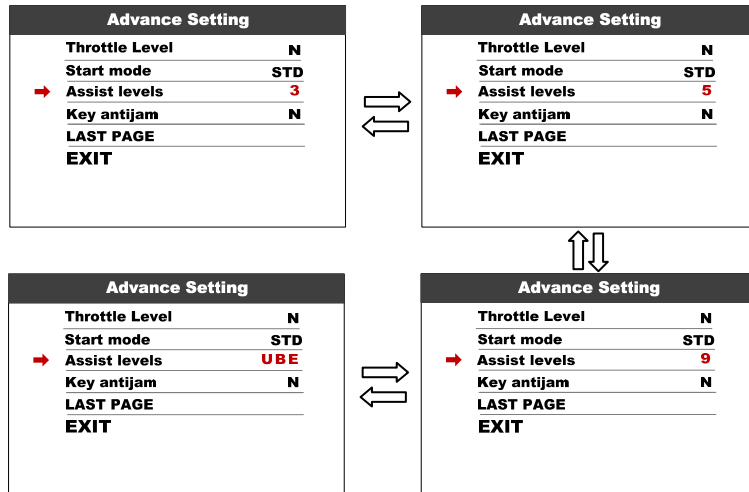

8.20 Key antijam: Key antijam N/Y, default value is N (OFF).

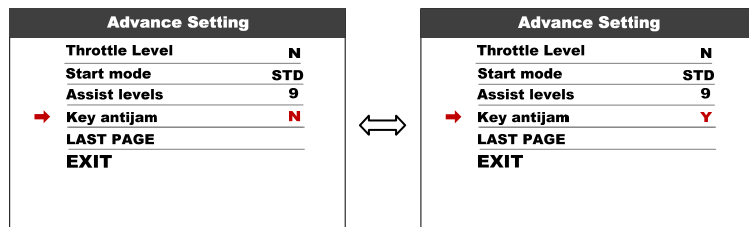

8.21 Factory setting: Press **MENU** button enter Restore Factory Settings item, set YES will restore all parameter to factory settings.

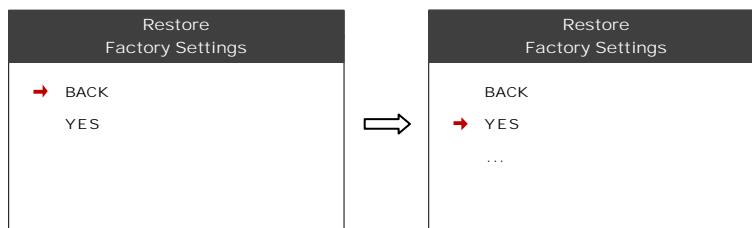

8.22 Information: Show information of the E-bike.

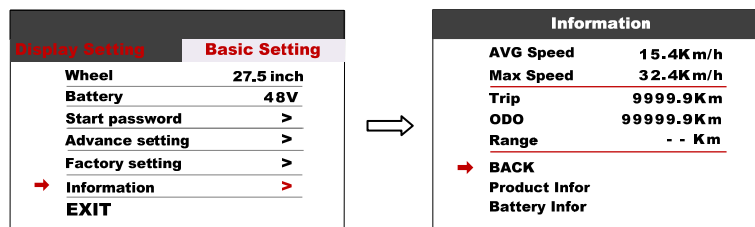

8.23 Product info: Get into this item can show hardware version software version...

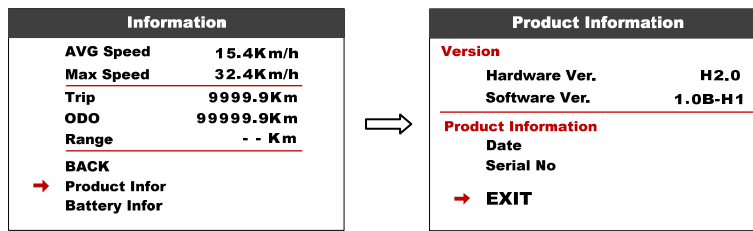

8.24 Battery info : Get into this item can show all information of battery, including Voltage, Capacity. [Cycle times, Health, Temperature of battery, Remaining Capacity, Full Charge Capacity, these items are invalid.]

*These information needs to be supported by battery communication.

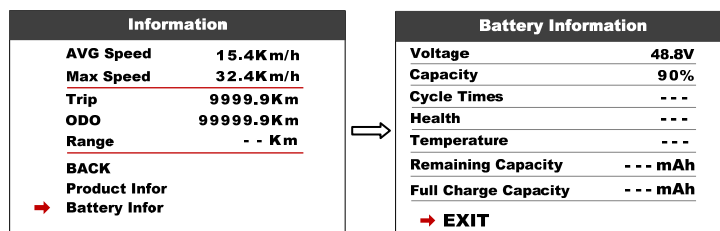

9. Error Code define

750C can show warning message, icon shows on the screen, and show error code at the bottom of the screen, error code from 01~07, definition see the table below.

Error Code	Error description	Handle
01	Communication Error	Check the cable connection
02	Controller protection	Check three-phase power line.
03	three-phase power error	Check three-phase power line connection
04	Battery low	Charge the battery
05	Brake error	Check the brake connection.
06	Throttle error	Check turn to connect.
07	Hall error	Check the hall connection
08-99	Reserved	Please contact the manufacturer for error definitions

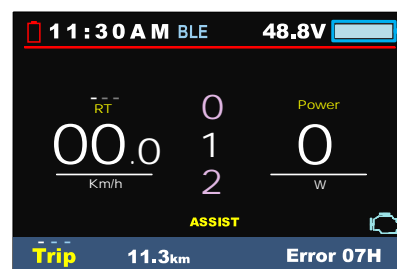
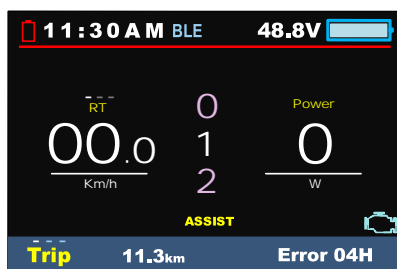

10. Assembly instructions

Please pay attention to the screw's torque value, damaged caused by excessive torque is not within the scope of the warranty.

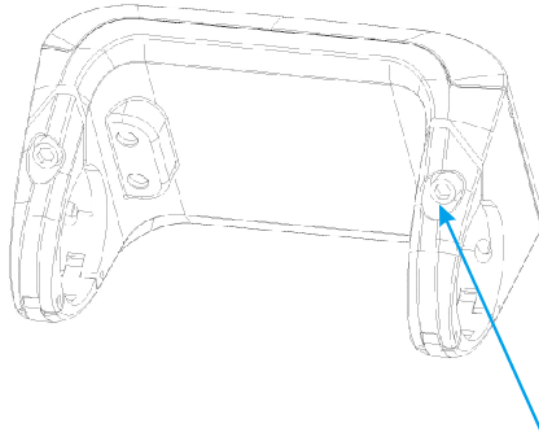

M4*10
STD=0.1N.M
MAX=0.2NM



M3*8
STD=0.25N.M
MAX=0.4N.M

Clamps suit for 3 size of handlebar, 31.8mm, 25.4mm, 22.2mm, there are transfer rings for 25.4mm and 22.2mm (marked with L or R), transfer ring must be assembled with the special directions, pay attention to the green arrow below.

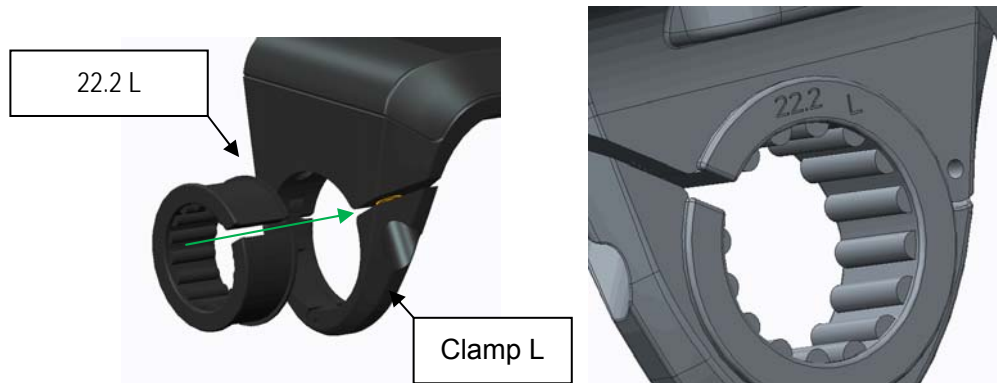

11. Connector descriptions

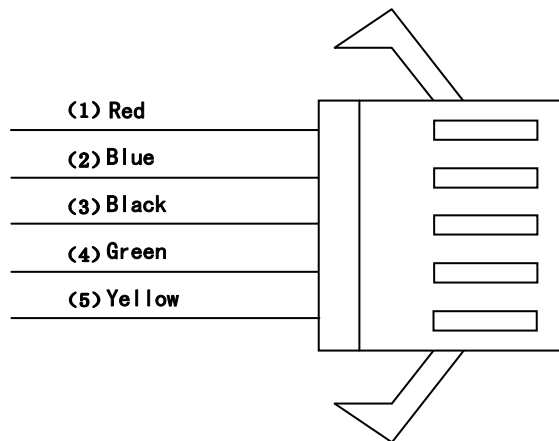

- 1、 Red wire : Anode(24v/36v/48V/52V)
- 2、 Blue wire : Power cord to the controller
- 3、 Black wire : GND
- 4、 Green wire : Rx D (controller -> display)
- 5、 Yellow wire : Tx D (display -> controller)

12. Assist level instructions

Assist level can be customized, the highest level is 9, common used assist level see the table below:

3 level	5 level	9 level	UBE (6level)	
0	0	0	0	No power assist
		1	1	
	1	2		
1		3	2	
	2	4		
2		5	3	

	3	6		
		7	4	
	4	8	5	
3	5	9	6	

13. Certification

CE / IP65 (water proof) / ROHS.