

Job Name:	
Tag#	



<b>Submittal Data Sheet</b>	<b>FTKB09AXVJU / RKB09AXVJU</b>
0.75-Ton Wall Mounted Cooling Only System	



Efficiency	
Cooling	
SEER	17
EER	11

Performance	
Cooling (Btu/hr)	
<b>Rated (Min/Max)</b>	8,800 (4,400 – 10,200)
<b>Sensible @ AHRI</b>	7,165
<b>Operating Range</b>	50°F – 115°F
<b>Rated Cooling Conditions:</b>	
Indoor:	80°F DB/67°F WB
Outdoor:	95°F DB/75°F WB

Complete warranty details available from your local dealer or at [www.daikincomfort.com](http://www.daikincomfort.com). To receive the 10-Year Parts Limited Warranty, online registration must be completed within 60 days of installation. Online registration is not required in California or Quebec. If product is installed in a commercial application, limited warranty period is 5 years.

Indoor Specifications		
Airflow Rate (cfm)	Cooling	
	H	M
	330	272
	L	
	215	
Sound (dBA) H / M / L	42 / 35 / 30	
Dimensions (H x W x D) (in)	11-11/16 x 35-1/16 x 8-1/4	
Weight (Lbs)	20	

Electrical		
	208/60/1	230/60/1
System MCA	6.95	6.95
System MFA	15	15
Compressor RLA	6.75	6.75
Outdoor fan motor FLA	.19	.19
Outdoor fan motor W	41	41
Indoor fan motor FLA	.20	.20
Indoor fan motor W	18	18
<b>MFA:</b> Max. fuse amps <b>MCA:</b> Min. circuit amps (A) <b>FLA:</b> Full load amps (A)		
<b>RLA:</b> Rated load amps (A) <b>W:</b> Fan motor rated output (W)		

Outdoor Specifications		
Compressor	Hermetically Sealed Swing Type	
Refrigerant	R-410A	
Factory Charge (Lbs)	1.625	
Refrigerant Oil	PVE (FVC50K)	
Airflow Rate (cfm)	Cooling	
	H	900
Sound Pressure Level (dBA)	46	
Dimensions (H x W x D) (in)	21-5/8 x 25-15/16 x 10-3/4	
Weight (Lbs)	53	

Piping	
Liquid (in)	1/4
Gas (in)	3/8
Drain (in)	3/4
Max. Interunit Piping Length (ft)	65.625
Max. Interunit Height Difference (ft)	32.8
Chargeless (ft)	24.6
Additional Charge of Refrigerant (oz/ft)	.21

Daikin North America LLC 5151 San Felipe, Suite 500 Houston, TX 77056

(Daikin's products are subject to continuous improvements. Daikin reserves the right to modify product design, specifications and information in this data sheet without notice and without incurring any obligations)

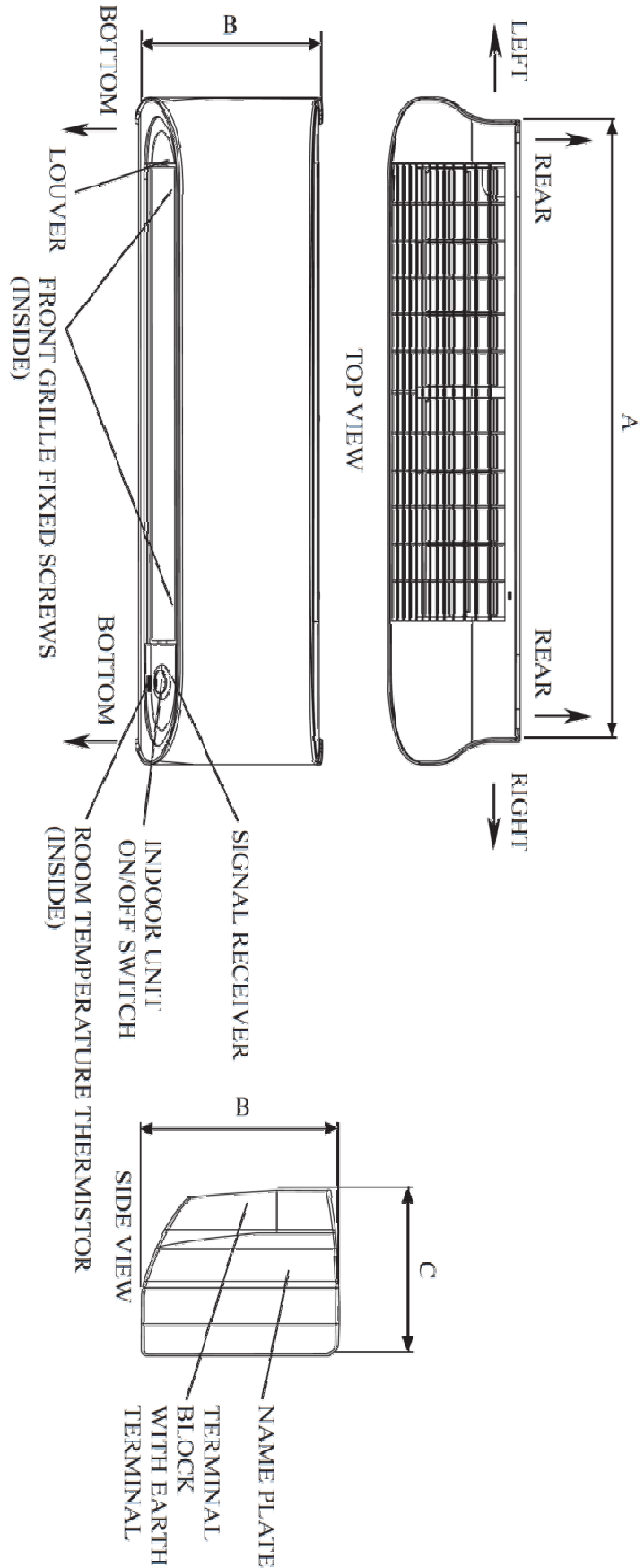

Model	Dimension		
09/12	A 35-1/16 (890)	B 11-11/16 (297)	C 8-1/4 (210)

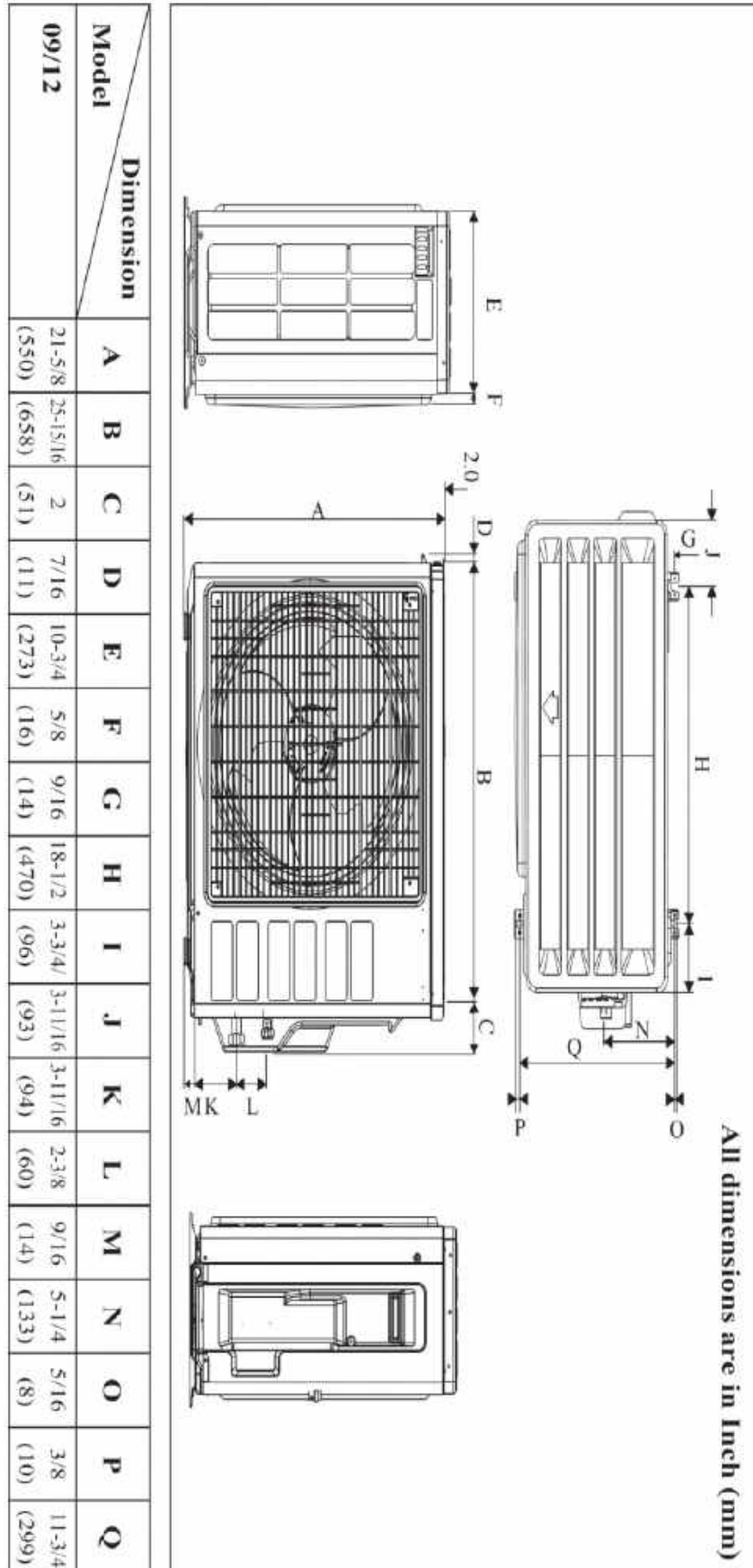

Daikin North America LLC 5151 San Felipe, Suite 500 Houston, TX 77056

(Daikin's products are subject to continuous improvements. Daikin reserves the right to modify product design, specifications and information in this data sheet without notice and without incurring any obligations)

# FTKB09AXVJU / RKB09AXVJU Performance Tables



## Cooling Mode

AFR (CFM)	EWB	EDB	Outdoor temperature																	
			66.2°F			77.0°F			86.0°F			95.0°F			104.0°F			114.8°F		
			TC	SC	PI	TC	SC	PI	TC	SC	PI	TC	SC	PI	TC	SC	PI	TC	SC	PI
215	61.6°F	69.2°F	8294	6258	0.61	8001	6094	0.66	7703	5930	0.71	7394	5760	0.77	6790	5360	0.84	6269	5042	0.92
		74.6°F	8305	7493	0.61	8010	7322	0.66	7714	7151	0.71	7405	6974	0.77	6803	6513	0.84	6293	6145	0.92
		80.0°F	8371	8371	0.61	8092	8092	0.66	7808	7808	0.71	7514	7514	0.77	6933	6933	0.84	6450	6450	0.93
	67.0°F	85.4°F	8628	8628	0.61	8381	8381	0.66	8127	8127	0.72	7865	7865	0.78	7290	7290	0.85	6821	6821	0.94
		74.6°F	9149	5842	0.62	8828	5694	0.67	8504	5543	0.72	8167	5386	0.79	7506	5017	0.85	6939	4724	0.94
		80.0°F	9155	6684	0.62	8832	6534	0.67	8509	6384	0.72	8174	6230	0.79	7513	5827	0.85	6948	5520	0.94
	72.4°F	85.4°F	9169	8249	0.62	8852	8073	0.67	8539	7894	0.72	8216	7704	0.79	7564	7205	0.85	7018	6818	0.94
		90.8°F	9278	9278	0.62	8976	8976	0.67	8685	8685	0.73	8388	8388	0.79	7761	7761	0.86	7256	7256	0.95
		80.0°F	10065	5718	0.63	9717	5580	0.68	9362	5440	0.74	8997	5291	0.80	8273	4930	0.87	7658	4648	0.96
	61.6°F	85.4°F	10068	6969	0.63	9720	6820	0.68	9364	6665	0.74	8998	6507	0.80	8276	6091	0.87	7661	5776	0.96
		90.8°F	10074	8139	0.63	9725	7984	0.68	9371	7825	0.74	9005	7664	0.80	8286	7194	0.87	7680	6834	0.96
		96.2°F	10106	9229	0.63	9773	9044	0.68	9433	8856	0.74	9090	8661	0.80	8383	8120	0.87	7794	7703	0.96
272	61.6°F	69.2°F	8632	6529	0.61	8320	6361	0.66	8005	6192	0.72	7678	6017	0.78	7045	5603	0.84	6499	5273	0.93
		74.6°F	8658	7925	0.61	8347	7740	0.66	8034	7555	0.72	7710	7365	0.78	7083	6871	0.85	6547	6485	0.93
		80.0°F	8762	8762	0.62	8468	8468	0.67	8176	8176	0.72	7882	7882	0.78	7277	7277	0.85	6779	6779	0.94
	67.0°F	85.4°F	9128	9128	0.62	8863	8863	0.67	8593	8593	0.73	8314	8314	0.79	7703	7703	0.86	7200	7200	0.95
		74.6°F	9510	6177	0.62	9171	6022	0.67	8827	5865	0.73	8472	5704	0.79	7780	5315	0.86	7187	5010	0.95
		80.0°F	9526	7115	0.62	9186	6958	0.67	8843	6800	0.73	8488	6639	0.79	7799	6206	0.86	7210	5876	0.95
	72.4°F	85.4°F	9572	8777	0.62	9239	8587	0.68	8908	8395	0.73	8567	8190	0.79	7888	7657	0.86	7319	7234	0.95
		90.8°F	9731	9731	0.63	9435	9435	0.68	9134	9134	0.74	8831	8831	0.80	8180	8180	0.87	7648	7648	0.96
		80.0°F	10449	6048	0.63	10081	5906	0.69	9706	5757	0.75	9320	5601	0.81	8565	5224	0.88	7922	4929	0.97
	61.6°F	85.4°F	10462	7421	0.63	10093	7268	0.69	9717	7105	0.75	9331	6940	0.81	8576	6500	0.88	7933	6168	0.97
		90.8°F	10480	8696	0.64	10116	8530	0.69	9745	8356	0.75	9361	8178	0.81	8612	7671	0.88	7983	7283	0.97
		96.2°F	10545	9831	0.64	10205	9645	0.69	9848	9444	0.75	9490	9224	0.81	8755	8632	0.88	8163	8143	0.97
330	61.6°F	69.2°F	8952	6814	0.62	8624	6641	0.67	8293	6466	0.72	7949	6285	0.78	7291	5854	0.85	6721	5509	0.94
		74.6°F	8999	8280	0.62	8672	8084	0.67	8346	7886	0.73	8009	7679	0.79	7355	7166	0.85	6795	6756	0.94
		80.0°F	9144	9144	0.62	8845	8845	0.67	8546	8546	0.73	8240	8240	0.79	7614	7614	0.86	7096	7096	0.95
	67.0°F	85.4°F	9602	9602	0.63	9321	9321	0.68	9034	9034	0.74	8737	8737	0.80	8090	8090	0.87	7555	7555	0.96
		74.6°F	9853	6536	0.63	9497	6375	0.68	9136	6211	0.74	8764	6043	0.80	8043	5634	0.87	7426	5314	0.95
		80.0°F	9882	7562	0.63	9527	7389	0.68	9169	7216	0.74	8800	7040	0.80	8080	6584	0.87	7467	6229	0.96
	72.4°F	85.4°F	9964	9306	0.63	9612	9103	0.68	9267	8895	0.74	8912	8672	0.80	8206	8100	0.87	7617	7617	0.96
		90.8°F	10180	10180	0.63	9882	9882	0.69	9578	9578	0.74	9262	9262	0.81	8580	8580	0.88	8025	8025	0.97
		80.0°F	10812	6394	0.64	10428	6254	0.69	10036	6097	0.75	9632	5937	0.82	8847	5540	0.88	8177	5231	0.97
	61.6°F	85.4°F	10835	7883	0.64	10449	7734	0.69	10056	7565	0.75	9652	7393	0.82	8868	6923	0.88	8202	6563	0.97
		90.8°F	10872	9238	0.64	10496	9077	0.69	10110	8886	0.75	9713	8690	0.82	8936	8145	0.89	8278	7730	0.98
		96.2°F	10969	10431	0.64	10626	10241	0.70	10258	10017	0.76	9889	9768	0.82	9137	9111	0.89	8524	8524	0.98

### Remark:

- AFR: Air flow rate (CFM)
- EWB: Entering Wet Bulb Temp. (°F)
- EDB: Entering Dry Bulb Temp. (°F)
- TC: Total Cooling Capacity (Btu/h)
- SC: Sensible Cooling Capacity (Btu/h)
- PI: Power Input (kW)

### Notes:

1. Ratings shown are net capacities.
2.  Shows nominal capacities.
3. Direct interpolation is permissible. Do not extrapolate.

Job Name:	
Tag#	



<b>Submittal Data Sheet</b>	<b>FTKB12AXVJU / RKB12AXVJU</b>
1.0-Ton Wall Mounted Cooling Only System	



Efficiency	
Cooling	
SEER	17
EER	8.5

Performance	
Cooling (Btu/hr)	
<b>Rated (Min/Max)</b>	11,000 (4,400 – 13,000)
<b>Sensible @ AHRI</b>	8,189
<b>Operating Range</b>	50°F – 115°F
<b>Rated Cooling Conditions:</b>	
Indoor:	80°F DB/67°F WB
Outdoor:	95°F DB/75°F WB

Complete warranty details available from your local dealer or at [www.daikincomfort.com](http://www.daikincomfort.com). To receive the 10-Year Parts Limited Warranty, online registration must be completed within 60 days of installation. Online registration is not required in California or Quebec. If product is installed in a commercial application, limited warranty period is 5 years.

Indoor Specifications		
Airflow Rate (cfm)	Cooling	
	H	M
	360	282
	L	
	232	
Sound (dBA) H / M / L	42 / 35 / 32	
Dimensions (H x W x D) (in)	11-11/16 x 35-1/16 x 8-1/4	
Weight (Lbs)	20	

Electrical		
	208/60/1	230/60/1
System MCA	7.7	7.7
System MFA	15	15
Compressor RLA	7.5	7.5
Outdoor fan motor FLA	.19	.19
Outdoor fan motor W	41	41
Indoor fan motor FLA	.20	.20
Indoor fan motor W	18	18
<b>MFA:</b> Max. fuse amps <b>MCA:</b> Min. circuit amps (A) <b>FLA:</b> Full load amps (A)		
<b>RLA:</b> Rated load amps (A) <b>W:</b> Fan motor rated output (W)		

Outdoor Specifications		
Compressor	Hermetically Sealed Swing Type	
Refrigerant	R-410A	
Factory Charge (Lbs)	2.20	
Refrigerant Oil	PVE (FVC50K)	
Airflow Rate (cfm)	Cooling	
	H	730
Sound Pressure Level (dBA)	48	
Dimensions (H x W x D) (in)	21-5/8 x 25-15/16 x 10-3/4	
Weight (Lbs)	57	

Piping	
Liquid (in)	1/4
Gas (in)	3/8
Drain (in)	3/4
Max. Interunit Piping Length (ft)	65.625
Max. Interunit Height Difference (ft)	32.8
Chargeless (ft)	24.6
Additional Charge of Refrigerant (oz/ft)	.21

Daikin North America LLC 5151 San Felipe, Suite 500 Houston, TX 77056

(Daikin's products are subject to continuous improvements. Daikin reserves the right to modify product design, specifications and information in this data sheet without notice and without incurring any obligations)

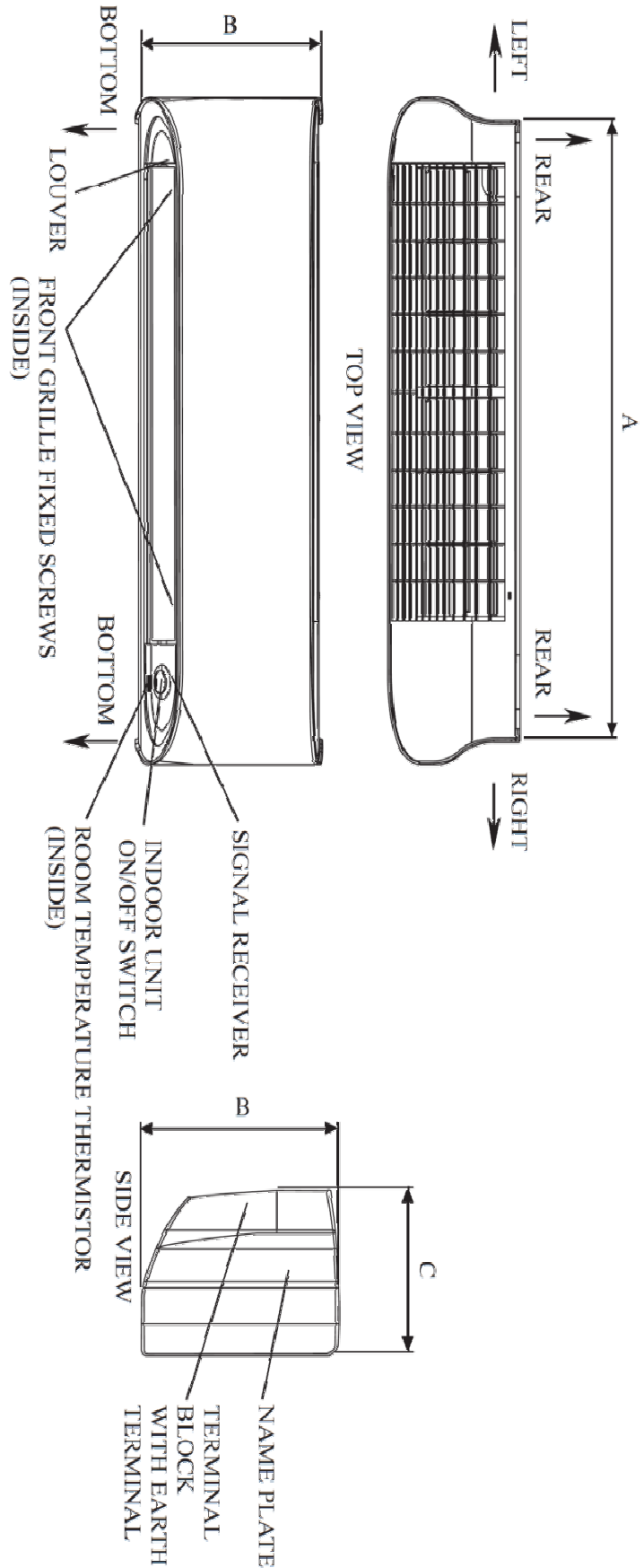

Model	Dimension		
09/12	A 35-1/16 (890)	B 11-11/16 (297)	C 8-1/4 (210)

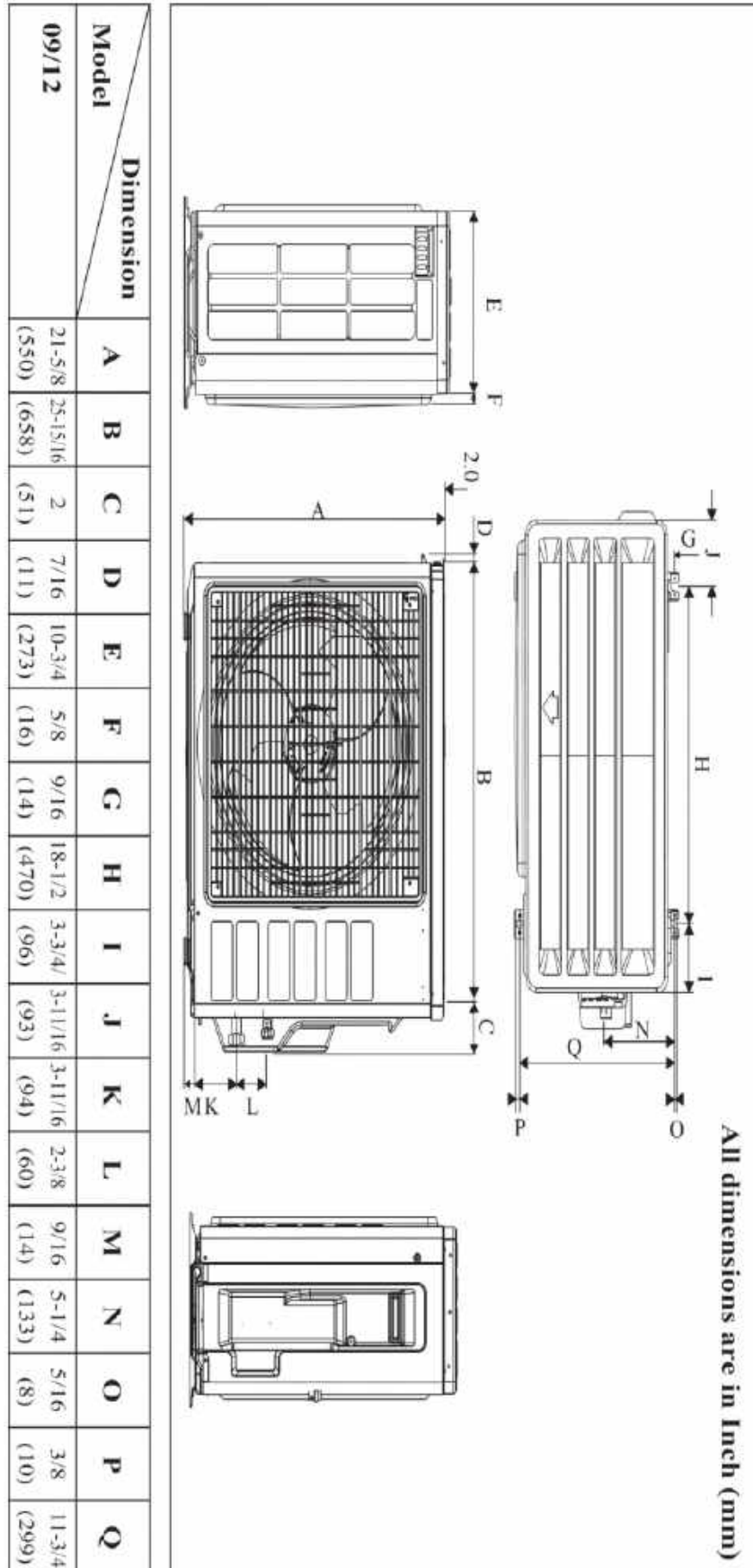

Daikin North America LLC 5151 San Felipe, Suite 500 Houston, TX 77056

(Daikin's products are subject to continuous improvements. Daikin reserves the right to modify product design, specifications and information in this data sheet without notice and without incurring any obligations)

# FTKB12AXVJU / RKB12AXVJU Performance Tables



## Cooling Mode

AFR 'CFM'	EWB	EDB	Outdoor temperature																	
			66.2°F			77.0°F			86.0°F			95.0°F			104.0°F			114.8°F		
			TC	SC	PI	TC	SC	PI	TC	SC	PI	TC	SC	PI	TC	SC	PI	TC	SC	PI
232	61.6°F	69.2°F	10368	7040	0.98	10002	6856	1.06	9630	6672	1.15	9243	6480	1.25	8488	6031	1.35	7836	5673	1.49
		74.6°F	10382	8430	0.98	10014	8237	1.06	9643	8046	1.15	9257	7846	1.25	8505	7327	1.36	7867	6914	1.49
		80.0°F	10464	9558	0.98	10116	9341	1.07	9760	9121	1.15	9393	8888	1.25	8667	8271	1.36	8064	7767	1.50
		85.4°F	10786	10786	0.99	10476	10476	1.07	10159	10159	1.16	9832	9832	1.26	9114	9114	1.37	8526	8526	1.51
	67.0°F	74.6°F	11437	6573	1.00	11035	6406	1.08	10630	6236	1.17	10210	6060	1.27	9383	5644	1.38	8674	5315	1.52
		80.0°F	11444	7520	1.00	11041	7351	1.08	10637	7183	1.17	10218	7009	1.27	9392	6556	1.38	8685	6211	1.52
		85.4°F	11462	9280	1.00	11066	9082	1.08	10675	8881	1.17	10270	8667	1.27	9456	8106	1.38	8773	7670	1.52
		90.8°F	11598	11598	1.00	11220	11220	1.08	10856	10856	1.18	10486	10486	1.28	9702	9702	1.39	9070	9070	1.53
	72.4°F	80.0°F	12582	6433	1.02	12146	6278	1.10	11704	6120	1.19	11246	5952	1.30	10342	5547	1.40	9573	5229	1.55
		85.4°F	12586	7840	1.02	12151	7673	1.10	11706	7499	1.19	11249	7321	1.30	10345	6853	1.41	9577	6499	1.55
		90.8°F	12593	9156	1.02	12157	8982	1.10	11714	8804	1.19	11257	8622	1.30	10358	8094	1.41	9601	7689	1.55
		96.2°F	12634	10383	1.02	12216	10175	1.10	11792	9964	1.20	11363	9743	1.30	10479	9135	1.41	9743	8667	1.55
282	61.6°F	69.2°F	10790	7345	0.99	10401	7156	1.07	10006	6966	1.16	9598	6769	1.26	8807	6303	1.37	8124	5932	1.51
		74.6°F	10823	8916	0.99	10433	8707	1.07	10043	8499	1.16	9638	8285	1.26	8854	7729	1.37	8184	7295	1.51
		80.0°F	10953	10126	0.99	10585	9890	1.08	10220	9636	1.17	9853	9349	1.27	9096	8684	1.37	8474	8123	1.52
		85.4°F	11409	11409	1.00	11079	11079	1.09	10742	10742	1.18	10393	10393	1.28	9629	9629	1.39	9001	9001	1.53
	67.0°F	74.6°F	11887	6949	1.01	11463	6774	1.09	11034	6598	1.18	10590	6416	1.28	9725	5979	1.39	8984	5636	1.53
		80.0°F	11908	8004	1.01	11483	7827	1.09	11054	7650	1.18	10610	7468	1.28	9748	6982	1.39	9012	6610	1.53
		85.4°F	11965	9874	1.01	11549	9660	1.09	11135	9444	1.18	10709	9213	1.29	9860	8614	1.39	9148	8138	1.54
		90.8°F	12164	12164	1.01	11794	11794	1.10	11418	11418	1.19	11039	11039	1.29	10225	10225	1.40	9560	9560	1.55
	72.4°F	80.0°F	13061	6803	1.03	12601	6644	1.11	12133	6476	1.21	11650	6301	1.31	10706	5877	1.42	9903	5545	1.56
		85.4°F	13077	8349	1.03	12616	8176	1.11	12146	7993	1.21	11664	7807	1.31	10720	7312	1.42	9917	6939	1.56
		90.8°F	13101	9783	1.03	12645	9596	1.11	12181	9400	1.21	11702	9200	1.31	10765	8630	1.42	9978	8193	1.56
		96.2°F	13181	11059	1.03	12756	10850	1.12	12310	10624	1.21	11863	10377	1.31	10944	9710	1.42	10204	9160	1.57
360	61.6°F	69.2°F	11191	7667	1.00	10781	7472	1.08	10367	7275	1.17	9937	7072	1.27	9114	6586	1.38	8402	6199	1.52
		74.6°F	11250	9316	1.00	10841	9095	1.08	10433	8872	1.17	10012	8639	1.27	9195	8062	1.38	8494	7602	1.52
		80.0°F	11431	10676	1.00	11057	10400	1.09	10684	10109	1.18	10300	9797	1.28	9519	9075	1.39	8870	8473	1.53
		85.4°F	12003	12003	1.01	11652	11652	1.10	11293	11293	1.19	10922	10922	1.29	10113	10113	1.40	9445	9445	1.55
	67.0°F	74.6°F	12318	7354	1.02	11872	7172	1.10	11421	6988	1.19	10956	6799	1.29	10055	6338	1.40	9283	5978	1.54
		80.0°F	12354	8508	1.02	11910	8314	1.10	11462	8119	1.19	11000	7920	1.29	10100	7407	1.40	9335	7008	1.55
		85.4°F	12456	10470	1.02	12015	10242	1.10	11585	10008	1.20	11141	9757	1.30	10258	9113	1.41	9522	8589	1.55
		90.8°F	12726	12726	1.02	12354	12354	1.11	11973	11973	1.20	11578	11578	1.31	10726	10726	1.42	10031	10031	1.57
	72.4°F	80.0°F	13516	7194	1.04	13036	7036	1.12	12546	6859	1.22	12041	6679	1.32	11060	6233	1.43	10222	5885	1.57
		85.4°F	13544	8869	1.04	13062	8701	1.12	12571	8511	1.22	12066	8318	1.32	11086	7789	1.43	10253	7384	1.58
		90.8°F	13591	10393	1.04	13121	10212	1.12	12639	9997	1.22	12142	9777	1.32	11171	9164	1.43	10349	8697	1.58
		96.2°F	13712	11735	1.04	13283	11522	1.13	12823	11270	1.22	12362	10990	1.33	11422	10251	1.44	10655	9651	1.59

### Remark:

- AFR: Air flow rate (CFM)
- EWB: Entering Wet Bulb Temp. (°F)
- EDB: Entering Dry Bulb Temp. (°F)
- TC: Total Cooling Capacity (Btu/h)
- SC: Sensible Cooling Capacity (Btu/h)
- PI: Power Input (kW)

### Notes:

1. Ratings shown are net capacities.
2.  Shows nominal capacities.
3. Direct interpolation is permissible. Do not extrapolate.



Job Name:	
Tag#	



<b>Submittal Data Sheet</b>	<b>FTKB18AXVJU / RKB18AXVJU</b>
1.5-Ton Wall Mounted Cooling Only System	



Efficiency	
Cooling	
SEER	17
EER	10.5

Performance	
Cooling (Btu/hr)	
Rated (Min/Max)	18,000 (4,300 – 21,200)
Sensible @ AHRI	12,932
Operating Range	50°F – 115°F
Rated Cooling Conditions:	Indoor: 80°F DB/67°F WB Outdoor: 95°F DB/75°F WB

Complete warranty details available from your local dealer or at [www.daikincomfort.com](http://www.daikincomfort.com). To receive the 10-Year Parts Limited Warranty, online registration must be completed within 60 days of installation. Online registration is not required in California or Quebec. If product is installed in a commercial application, limited warranty period is 5 years.

Indoor Specifications		
Airflow Rate (cfm)	Cooling	
	H	M
	430	374
	L	
	318	
Sound (dBA) H / M / L	40 / 37 / 35	
Dimensions (H x W x D) (in)	12-5/8 x 46-1/8 x 9-1/2	
Weight (Lbs)	31	

Electrical		
	208/60/1	230/60/1
System MCA	13.2	13.2
System MFA	20	20
Compressor RLA	13	13
Outdoor fan motor FLA	.50	.50
Outdoor fan motor W	61	61
Indoor fan motor FLA	.24	.24
Indoor fan motor W	40	40
MFA: Max. fuse amps MCA: Min. circuit amps (A) FLA: Full load amps (A) RLA: Rated load amps (A) W: Fan motor rated output (W)		

Outdoor Specifications		
Compressor	Hermetically Sealed Swing Type	
Refrigerant	R-410A	
Factory Charge (Lbs)	2.75	
Refrigerant Oil	PVE (FVC50K)	
Airflow Rate (cfm)	Cooling	
	H	1690
Sound Pressure Level (dBA)	53	
Dimensions (H x W x D) (in)	25-11/16 x 33-11/16 x 12-15/16	
Weight (Lbs)	82	

Piping	
Liquid (in)	1/4
Gas (in)	1/2
Drain (in)	3/4
Max. Interunit Piping Length (ft)	98.4
Max. Interunit Height Difference (ft)	32.8
Chargeless (ft)	24.6
Additional Charge of Refrigerant (oz/ft)	.21

Daikin North America LLC 5151 San Felipe, Suite 500 Houston, TX 77056

(Daikin's products are subject to continuous improvements. Daikin reserves the right to modify product design, specifications and information in this data sheet without notice and without incurring any obligations)

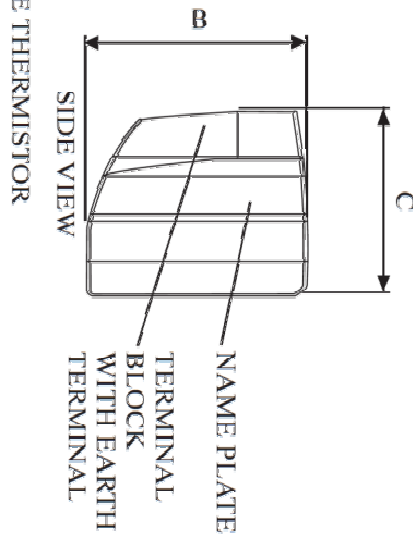
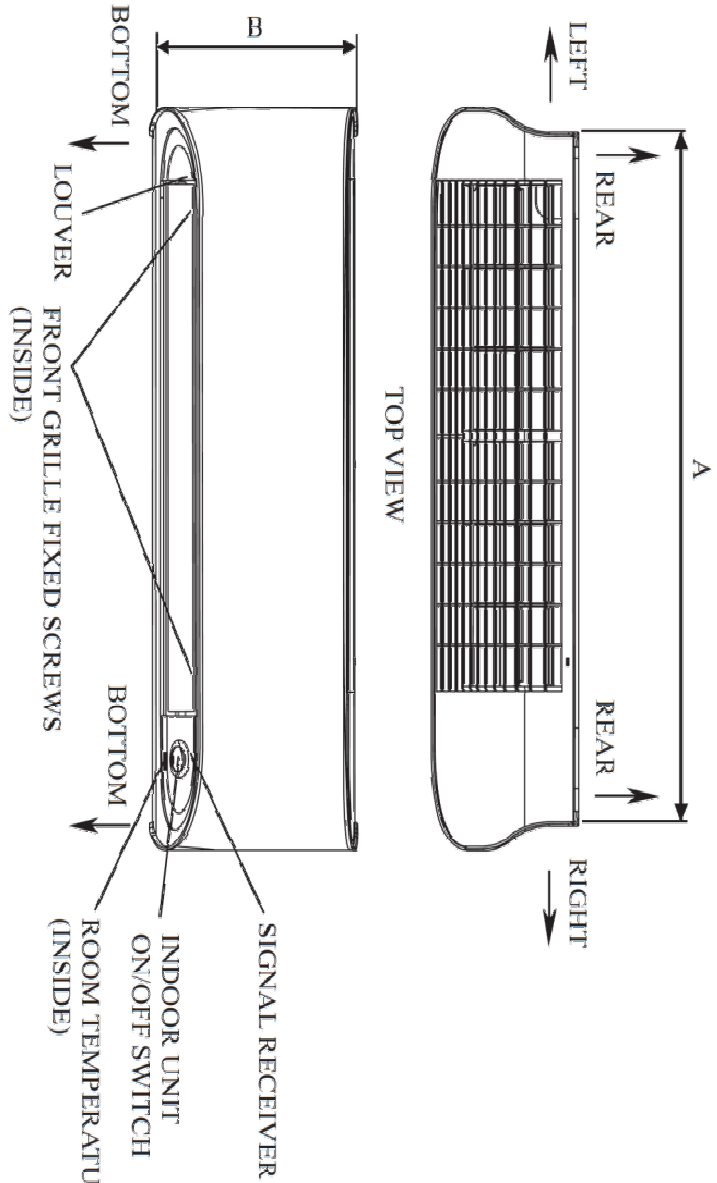

Model	Dimension		
18/24	A 46-1/8 (1172)	B 12-5/8 (320)	C 9-1/2 (242)

# RKB18AXVJU Dimensional Data

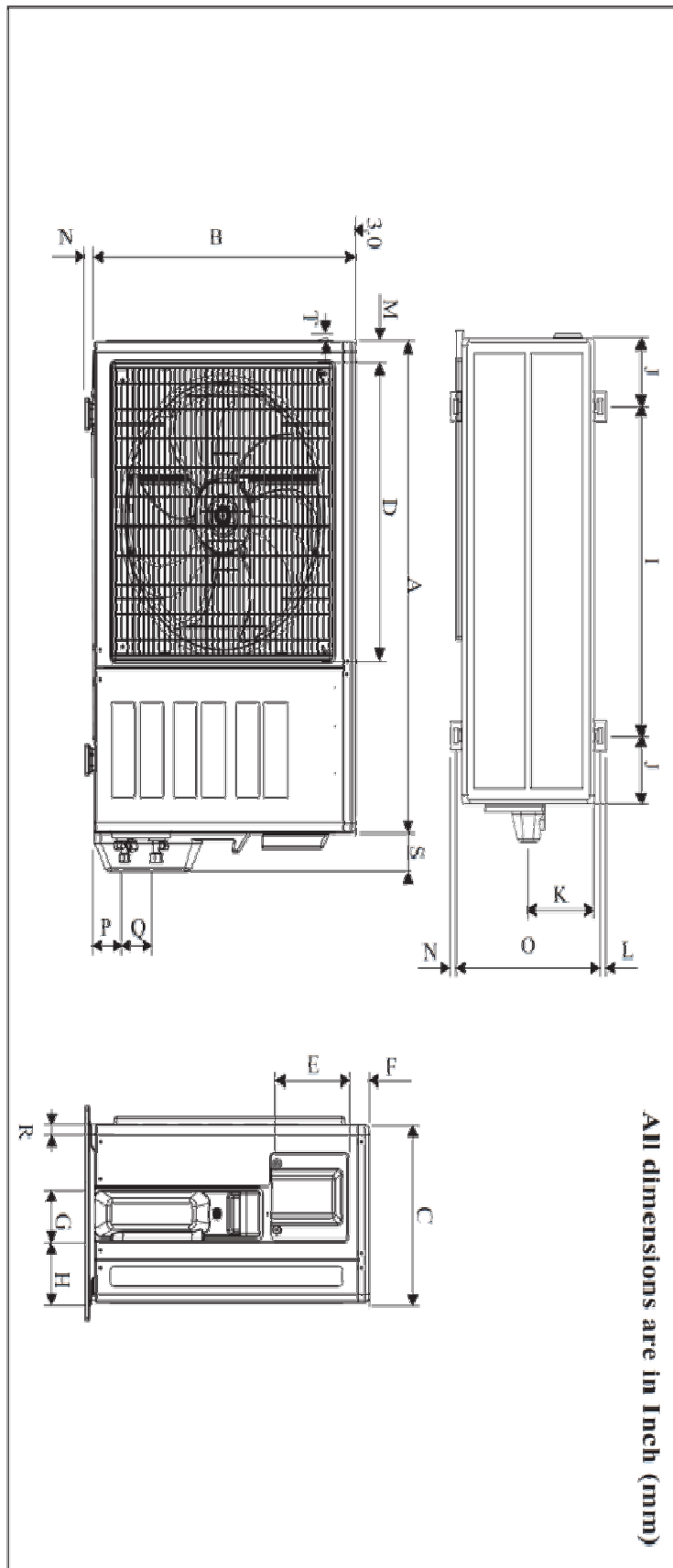

All dimensions are in Inch (mm)

Model	A	B	C	D	E	F	G	H	I	J	K	L	M	N	O
18	33-11/16 (855)	24-3/4 (628)	12-15/16 (328)	20-1/2 (520)	7-1/16 (179)	5-3/4 (46)	4 (101)	4-7/16 (113)	23-3/4 (603)	4-15/16 (126)	6-7/16 (164)	9/16 (15)	1-5/16 (34)	15/16 (23)	14-1/4 (362)
24	33-11/16 (855)	28-3/4 (730)	12-15/16 (328)	20-1/2 (520)	7-1/16 (179)	5-3/4 (46)	4 (101)	4-7/16 (113)	23-3/4 (603)	4-15/16 (126)	6-7/16 (164)	9/16 (15)	1-5/16 (34)	15/16 (23)	14-1/4 (362)

Dimension	P	Q	R	S	T
18	2-7/8 (73)	2-15/16 (75)	5/16 (8)	2-5/8 (67)	1/4 (7)
24	2-7/8 (73)	2-15/16 (75)	5/16 (8)	2-5/8 (67)	1/4 (7)

Daikin North America LLC 5151 San Felipe, Suite 500 Houston, TX 77056

(Daikin's products are subject to continuous improvements. Daikin reserves the right to modify product design, specifications and information in this data sheet without notice and without incurring any obligations)

# FTKB18AXVJU / RKB18AXVJU Performance Tables



## Cooling Mode

AFR 'CFM'	EWB	EDB	Outdoor temperature																	
			66.2°F			77.0°F			86.0°F			95.0°F			104.0°F			114.8°F		
			TC	SC	PI	TC	SC	PI	TC	SC	PI	TC	SC	PI	TC	SC	PI	TC	SC	PI
318	61.6°F	69.2°F	16971	11207	1.30	16371	10914	1.41	15762	10620	1.52	15130	10316	1.65	13893	9600	1.79	12826	9030	1.97
		74.6°F	16994	13419	1.30	16390	13112	1.41	15783	12807	1.52	15152	12489	1.65	13921	11664	1.79	12876	11005	1.97
		80.0°F	17128	15215	1.30	16558	14869	1.41	15976	14518	1.53	15374	14147	1.65	14186	13165	1.80	13198	12364	1.98
		85.4°F	17655	17655	1.31	17148	17148	1.42	16628	16628	1.54	16093	16093	1.67	14917	14917	1.81	13956	13956	2.00
	67.0°F	74.6°F	18719	10463	1.32	18063	10198	1.43	17400	9926	1.55	16711	9646	1.68	15358	8984	1.82	14198	8460	2.01
		80.0°F	18732	11971	1.32	18072	11701	1.43	17411	11433	1.55	16725	11156	1.68	15373	10436	1.82	14216	9886	2.01
		85.4°F	18761	14772	1.32	18113	14457	1.43	17473	14137	1.55	16810	13797	1.68	15478	12902	1.82	14359	12210	2.01
		90.8°F	18983	18983	1.32	18365	18365	1.43	17770	17770	1.55	17164	17164	1.69	15881	15881	1.83	14847	14847	2.02
	72.4°F	80.0°F	20594	10241	1.34	19881	9993	1.46	19157	9743	1.58	18408	9475	1.71	16927	8829	1.86	15669	8324	2.05
		85.4°F	20601	12480	1.34	19889	12214	1.46	19160	11937	1.58	18412	11653	1.71	16933	10908	1.86	15675	10344	2.05
		90.8°F	20612	14575	1.34	19899	14298	1.46	19174	14014	1.58	18425	13724	1.71	16955	12884	1.86	15714	12239	2.05
		96.2°F	20679	16528	1.35	19996	16197	1.46	19302	15860	1.58	18600	15510	1.72	17152	14541	1.86	15948	13796	2.05
374	61.6°F	69.2°F	17659	11688	1.31	17021	11387	1.42	16376	11084	1.54	15707	10772	1.66	14412	10030	1.81	13296	9440	1.99
		74.6°F	17712	14187	1.31	17075	13855	1.42	16436	13524	1.54	15772	13184	1.67	14490	12300	1.81	13394	11608	1.99
		80.0°F	17925	16114	1.31	17323	15738	1.42	16725	15334	1.54	16125	14877	1.67	14886	13818	1.82	13869	12926	2.00
		85.4°F	18672	18672	1.32	18132	18132	1.43	17579	17579	1.56	17008	17008	1.69	15759	15759	1.83	14730	14730	2.03
	67.0°F	74.6°F	19454	11058	1.33	18761	10780	1.44	18058	10499	1.56	17331	10210	1.69	15916	9514	1.84	14704	8968	2.02
		80.0°F	19488	12736	1.33	18793	12455	1.44	18090	12173	1.56	17364	11884	1.70	15954	11110	1.84	14749	10519	2.03
		85.4°F	19581	15712	1.33	18900	15372	1.44	18223	15028	1.57	17527	14660	1.70	16137	13708	1.84	14972	12950	2.03
		90.8°F	19908	19908	1.34	19301	19301	1.45	18686	18686	1.57	18066	18066	1.71	16734	16734	1.86	15645	15645	2.05
	72.4°F	80.0°F	21375	10826	1.36	20623	10572	1.47	19856	10305	1.59	19067	10027	1.73	17521	9352	1.87	16206	8824	2.06
		85.4°F	21401	13285	1.36	20647	13010	1.47	19877	12720	1.59	19089	12423	1.73	17544	11635	1.87	16229	11041	2.06
		90.8°F	21440	15568	1.36	20695	15270	1.47	19935	14959	1.60	19150	14640	1.73	17618	13732	1.88	16330	13038	2.07
		96.2°F	21572	17598	1.36	20876	17265	1.47	20146	16906	1.60	19414	16512	1.74	17911	15452	1.88	16699	14577	2.08
430	61.6°F	69.2°F	18313	12197	1.32	17641	11887	1.43	16964	11574	1.55	16261	11250	1.68	14914	10478	1.82	13748	9861	2.01
		74.6°F	18409	14821	1.32	17739	14469	1.43	17072	14115	1.55	16382	13744	1.68	15046	12826	1.82	13900	12093	2.01
		80.0°F	18705	16984	1.33	18093	16546	1.44	17482	16082	1.56	16855	15585	1.69	15576	14437	1.83	14514	13479	2.02
		85.4°F	19641	19641	1.34	19066	19066	1.45	18480	18480	1.57	17872	17872	1.71	16548	16548	1.86	15455	15455	2.05
	67.0°F	74.6°F	20156	11699	1.34	19427	11410	1.45	18688	11117	1.58	17928	10816	1.71	16453	10083	1.85	15190	9511	2.04
		80.0°F	20215	13535	1.34	19489	13226	1.46	18756	12916	1.58	18000	12600	1.71	16527	11784	1.85	15274	11148	2.04
		85.4°F	20382	16657	1.35	19661	16294	1.46	18957	15921	1.58	18230	15522	1.71	16785	14497	1.86	15582	13665	2.05
		90.8°F	20824	20824	1.35	20215	20215	1.47	19592	19592	1.59	18946	18946	1.73	17552	17552	1.88	16415	16415	2.07
	72.4°F	80.0°F	22117	11444	1.37	21331	11194	1.48	20529	10913	1.61	19703	10626	1.74	18098	9915	1.89	16726	9363	2.08
		85.4°F	22163	14109	1.37	21373	13842	1.48	20570	13540	1.61	19743	13233	1.74	18140	12391	1.89	16777	11747	2.08
		90.8°F	22240	16535	1.37	21471	16246	1.49	20681	15904	1.61	19868	15553	1.75	18279	14578	1.89	16934	13835	2.09
		96.2°F	22437	18670	1.37	21735	18330	1.49	20983	17929	1.62	20229	17484	1.75	18691	16308	1.90	17435	15353	2.10

### Remark:

- AFR: Air flow rate (CFM)
- EWB: Entering Wet Bulb Temp. (°F)
- EDB: Entering Dry Bulb Temp. (°F)
- TC: Total Cooling Capacity (Btu/h)
- SC: Sensible Cooling Capacity (Btu/h)
- PI: Power Input (kW)

### Notes:

1. Ratings shown are net capacities.
2.  Shows nominal capacities.
3. Direct interpolation is permissible. Do not extrapolate.

Job Name:	
Tag#	



<b>Submittal Data Sheet</b>	<b>FTKB24AXVJU / RKB24AXVJU</b>
2.0-Ton Wall Mounted Cooling Only System	



Complete warranty details available from your local dealer or at [www.daikincomfort.com](http://www.daikincomfort.com). To receive the 10-Year Parts Limited Warranty, online registration must be completed within 60 days of installation. Online registration is not required in California or Quebec. If product is installed in a commercial application, limited warranty period is 5 years.

Efficiency	
Cooling	
SEER	17
EER	11

Performance	
Cooling (Btu/hr)	
<b>Rated (Min/Max)</b>	21,200 (6,000 – 22,200)
<b>Sensible @ AHRI</b>	15,116
<b>Operating Range</b>	50°F – 115°F
<b>Rated Cooling Conditions:</b>	
Indoor:	80°F DB/67°F WB
Outdoor:	95°F DB/75°F WB

Indoor Specifications		
Airflow Rate (cfm)	Cooling	
	H	M
	555	486
	L	
	405	
Sound (dBA) H / M / L	47 / 44 / 41	
Dimensions (H x W x D) (in)	12-5/8 x 46-1/8 x 9-1/2	
Weight (Lbs)	31	

Electrical		
	208/60/1	230/60/1
System MCA	13.2	13.2
System MFA	20	20
Compressor RLA	13	13
Outdoor fan motor FLA	.50	.50
Outdoor fan motor W	61	61
Indoor fan motor FLA	.24	.24
Indoor fan motor W	40	40
<b>MFA:</b> Max. fuse amps <b>MCA:</b> Min. circuit amps (A) <b>FLA:</b> Full load amps (A)		
<b>RLA:</b> Rated load amps (A) <b>W:</b> Fan motor rated output (W)		

Outdoor Specifications		
Compressor	Hermetically Sealed Swing Type	
Refrigerant	R-410A	
Factory Charge (Lbs)	3.20	
Refrigerant Oil	PVE (FVC50K)	
Airflow Rate (cfm)	Cooling	
	H	1796
Sound Pressure Level (dBA)	52	
Dimensions (H x W x D) (in)	29-11/16 x 33-11/16 x 12-15/16	
Weight (Lbs)	97	

Piping	
Liquid (in)	1/4
Gas (in)	5/8
Drain (in)	3/4
Max. Interunit Piping Length (ft)	98.4
Max. Interunit Height Difference (ft)	32.8
Chargeless (ft)	24.6
Additional Charge of Refrigerant (oz/ft)	.21

Daikin North America LLC 5151 San Felipe, Suite 500 Houston, TX 77056

(Daikin's products are subject to continuous improvements. Daikin reserves the right to modify product design, specifications and information in this data sheet without notice and without incurring any obligations)

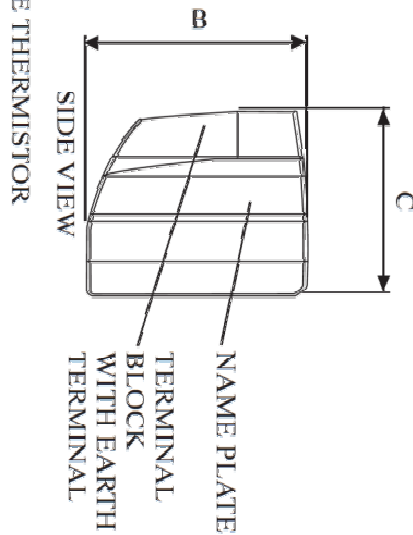
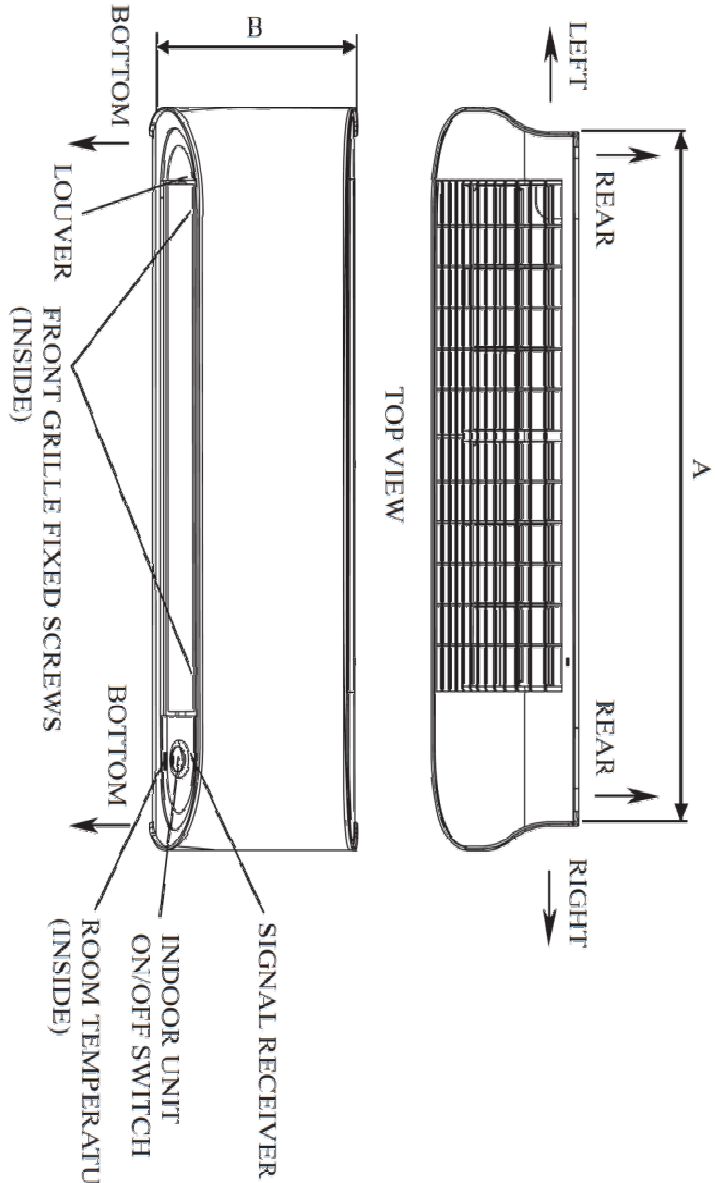

Model	Dimension		
18/24	A	B	C
	46-1/8 (1172)	12-5/8 (320)	9-1/2 (242)

# RKB24AXVJU Dimensional Data

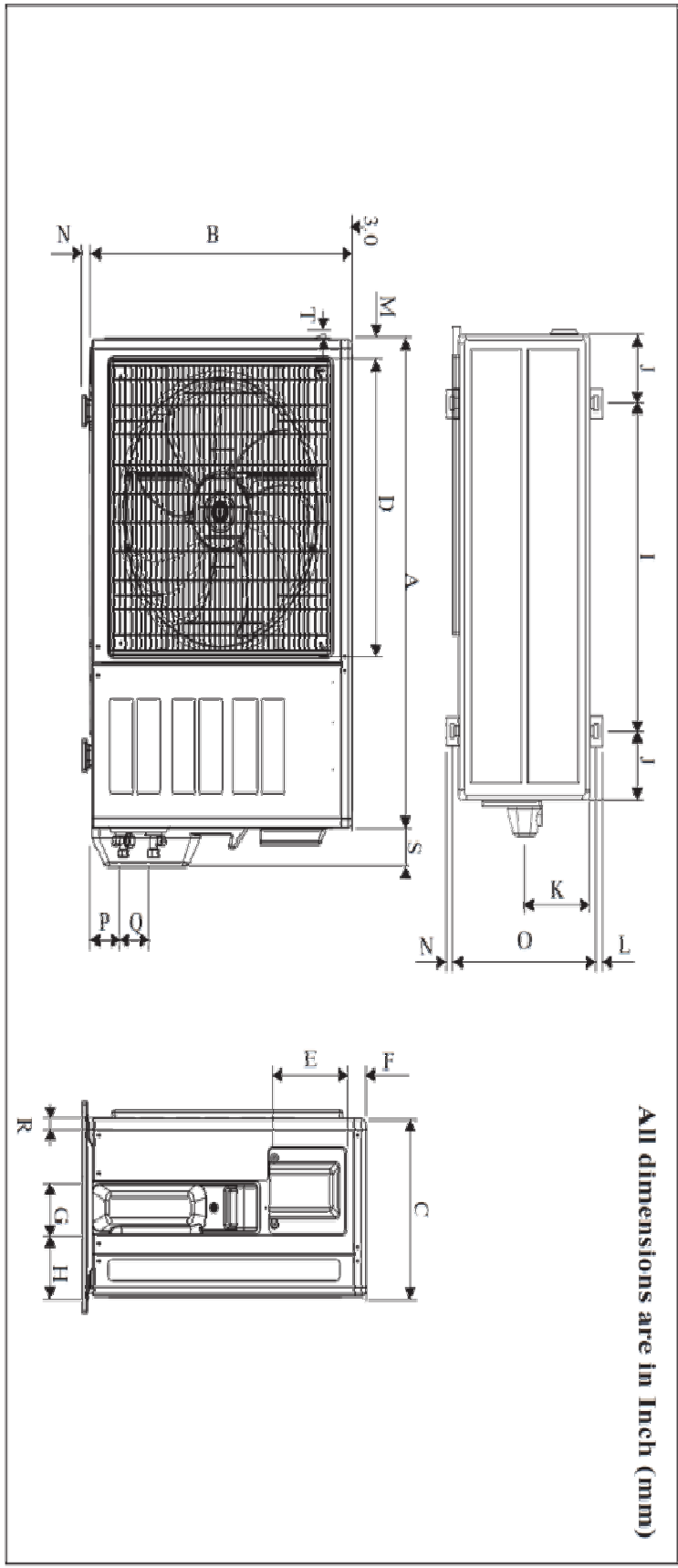

Model	A	B	C	D	E	F	G	H	I	J	K	L	M	N	O
18	33-11/16 (855)	24-3/4 (628)	12-15/16 (328)	20-1/2 (520)	7-1/16 (179)	5-3/4 (46)	4 (101)	4-7/16 (113)	23-3/4 (603)	4-15/16 (126)	6-7/16 (164)	9/16 (15)	1-5/16 (34)	15/16 (23)	14-1/4 (362)
24	33-11/16 (855)	28-3/4 (730)	12-15/16 (328)	20-1/2 (520)	7-1/16 (179)	5-3/4 (46)	4 (101)	4-7/16 (113)	23-3/4 (603)	4-15/16 (126)	6-7/16 (164)	9/16 (15)	1-5/16 (34)	15/16 (23)	14-1/4 (362)

Model	P	Q	R	S	T
18	2-7/8 (73)	2-15/16 (75)	5/16 (8)	2-5/8 (67)	1/4 (7)
24	2-7/8 (73)	2-15/16 (75)	5/16 (8)	2-5/8 (67)	1/4 (7)

Daikin North America LLC 5151 San Felipe, Suite 500 Houston, TX 77056

(Daikin's products are subject to continuous improvements. Daikin reserves the right to modify product design, specifications and information in this data sheet without notice and without incurring any obligations)

# FTKB24AXVJU / RKB24AXVJU Performance Tables



## Cooling Mode

AFR 'CFM'	EWB	EDB	Outdoor temperature																		
			66.2°F			77.0°F			86.0°F			95.0°F			104.0°F			114.8°F			
			TC	SC	PI	TC	SC	PI	TC	SC	PI	TC	SC	PI	TC	SC	PI	TC	SC	PI	
405	61.6°F	69.2°F	19988	13198	1.46	19281	12853	1.58	18564	12508	1.71	17819	12149	1.86	16363	11306	2.02	15107	10635	2.22	
		74.6°F	20014	15804	1.46	19304	15442	1.58	18589	15083	1.72	17846	14708	1.86	16395	13737	2.02	15165	12961	2.22	
		80.0°F	20172	17919	1.47	19501	17512	1.59	18816	17099	1.72	18107	16662	1.86	16707	15505	2.02	15545	14561	2.23	
	67.0°F	85.4°F	20793	20793	1.47	20196	20196	1.60	19584	19584	1.73	18954	18954	1.88	17569	17569	2.04	16437	16437	2.25	
		74.6°F	22047	12322	1.49	21274	12010	1.61	20493	11690	1.74	19682	11360	1.89	18088	10581	2.05	16722	9964	2.26	
		80.0°F	22062	14098	1.49	21285	13781	1.61	20506	13465	1.74	19698	13139	1.89	18106	12291	2.05	16743	11643	2.26	
	72.4°F	85.4°F	22096	17397	1.49	21333	17027	1.61	20579	16649	1.75	19798	16249	1.89	18229	15196	2.06	16912	14380	2.27	
		90.8°F	22358	22358	1.49	21630	21630	1.62	20929	20929	1.75	20215	20215	1.90	18704	18704	2.07	17486	17486	2.28	
		80.0°F	24255	12061	1.51	23416	11769	1.64	22562	11474	1.78	21681	11159	1.93	19936	10398	2.09	18455	9803	2.31	
	486	61.6°F	85.4°F	24263	14698	1.51	23425	14385	1.64	22566	14058	1.78	21685	13724	1.93	19944	12847	2.09	18461	12183	2.31
			90.8°F	24276	17165	1.51	23436	16839	1.64	22583	16505	1.78	21701	16164	1.93	19969	15174	2.09	18508	14414	2.31
			96.2°F	24355	19465	1.52	23550	19075	1.64	22733	18679	1.78	21906	18266	1.93	20202	17126	2.10	18783	16247	2.31
67.0°F	69.2°F	20799	13766	1.48	20048	13412	1.60	19288	13055	1.73	18500	12687	1.88	16975	11814	2.03	15660	11119	2.24		
	74.6°F	20861	16710	1.48	20111	16318	1.60	19359	15929	1.73	18577	15528	1.88	17066	14487	2.04	15776	13673	2.24		
	80.0°F	21112	18979	1.48	20403	18537	1.60	19700	18060	1.74	18992	17523	1.88	17533	16275	2.05	16335	15224	2.26		
72.4°F	85.4°F	21992	21992	1.49	21356	21356	1.62	20705	20705	1.75	20032	20032	1.90	18561	18561	2.07	17349	17349	2.28		
	90.8°F	22914	13024	1.50	22096	12697	1.63	21268	12366	1.76	20413	12026	1.91	18746	11206	2.07	17318	10563	2.28		
	80.0°F	22954	15001	1.50	22135	14670	1.63	21307	14338	1.76	20452	13998	1.91	18791	13086	2.07	17372	12390	2.28		
555	61.6°F	85.4°F	23063	18506	1.50	22261	18105	1.63	21463	17700	1.76	20643	17267	1.91	19007	16145	2.08	17634	15253	2.29	
		90.8°F	23448	23448	1.51	22733	22733	1.63	22008	22008	1.77	21278	21278	1.93	19709	19709	2.09	18427	18427	2.31	
		80.0°F	25176	12751	1.53	24290	12452	1.66	23387	12137	1.80	22457	11810	1.95	20637	11015	2.11	19088	10393	2.33	
	67.0°F	85.4°F	25207	15648	1.53	24318	15323	1.66	23412	14981	1.80	22483	14632	1.95	20664	13704	2.11	19115	13005	2.33	
		90.8°F	25252	18336	1.53	24374	17986	1.66	23480	17619	1.80	22556	17243	1.95	20751	16174	2.11	19234	15357	2.33	
		96.2°F	25408	20728	1.53	24587	20335	1.66	23729	19912	1.80	22866	19448	1.96	21096	18200	2.12	19669	17169	2.34	
	72.4°F	69.2°F	21569	14365	1.49	20777	14000	1.61	19980	13632	1.74	19152	13250	1.89	17566	12341	2.05	16192	11615	2.26	
		74.6°F	21682	17456	1.49	20893	17042	1.61	20108	16624	1.75	19295	16188	1.89	17721	15106	2.05	16371	14243	2.26	
		80.0°F	22031	20004	1.50	21311	19488	1.62	20591	18942	1.75	19852	18356	1.90	18345	17004	2.07	17095	15875	2.28	
	61.6°F	85.4°F	23133	23133	1.51	22456	22456	1.63	21765	21765	1.77	21049	21049	1.92	19490	19490	2.09	18203	18203	2.31	
		90.8°F	23739	13779	1.51	22881	13439	1.64	22011	13094	1.78	21115	12739	1.93	19378	11876	2.09	17890	11202	2.30	
		80.0°F	23809	15942	1.51	22954	15577	1.64	22091	15213	1.78	21200	14840	1.93	19466	13879	2.09	17990	13130	2.30	
67.0°F	85.4°F	24006	19619	1.52	23157	19191	1.64	22327	18752	1.78	21472	18282	1.93	19770	17075	2.10	18352	16094	2.31		
	90.8°F	24527	24527	1.52	23809	23809	1.65	23075	23075	1.79	22315	22315	1.95	20673	20673	2.12	19333	19333	2.34		
	80.0°F	26050	13479	1.54	25124	13184	1.67	24179	12853	1.81	23206	12515	1.96	21315	11678	2.13	19700	11028	2.34		
72.4°F	85.4°F	26104	16617	1.54	25174	16304	1.67	24227	15948	1.81	23254	15585	1.96	21365	14594	2.13	19760	13835	2.35		
	90.8°F	26194	19475	1.54	25288	19135	1.67	24358	18732	1.81	23401	18319	1.97	21529	17170	2.13	19945	16295	2.35		
	96.2°F	26427	21989	1.55	25600	21589	1.68	24714	21116	1.82	23825	20592	1.98	22014	19208	2.15	20535	18082	2.37		

### Remark:

- AFR: Air flow rate (CFM)
- EWB: Entering Wet Bulb Temp. (°F)
- EDB: Entering Dry Bulb Temp. (°F)
- TC: Total Cooling Capacity (Btu/h)
- SC: Sensible Cooling Capacity (Btu/h)
- PI: Power Input (kW)

### Notes:

1. Ratings shown are net capacities.
2.  Shows nominal capacities.
3. Direct interpolation is permissible. Do not extrapolate.



Job Name:	
Tag#	



<b>Submittal Data Sheet</b>	<b>FTXB09AXVJU / RXB09AXVJU</b>
0.75-Ton Wall Mounted Heat Pump System	



Complete warranty details available from your local dealer or at [www.daikincomfort.com](http://www.daikincomfort.com). To receive the 10-Year Parts Limited Warranty, online registration must be completed within 60 days of installation. Online registration is not required in California or Quebec. *If product is installed in a commercial application, limited warranty period is 5 years.*

### Indoor Specifications

	Cooling		Heating	
	H	M	H	M
Airflow Rate (cfm)	330	272	330	272
	L		L	
	215		215	
Sound (dBA) H / M / L / SL	42 / 35 / 30			
Dimensions (H x W x D) (in)	11-11/16 x 35-1/16 x 8-1/4			
Weight (Lbs)	20			

### Outdoor Specifications

Compressor	Hermetically Sealed Swing Type			
Refrigerant	R-410A			
Factory Charge (Lbs)	1.625			
Refrigerant Oil	PVE (FVC50K)			
Airflow Rate (cfm)	Cooling		Heating	
	H	900	H	900
Sound Pressure Level (dBA)	46			
Dimensions (H x W x D) (in)	21-5/8 x 25-15/16 x 10-3/4			
Weight (Lbs)	53			

### Efficiency

Cooling		Heating	
SEER	17	HSPF	9
EER	11	COP	3.56

### Performance

Cooling (Btu/hr)	
Rated (Min/Max)	8,800 (4,400 – 10,200)
Sensible @ AHRI	7,677
Operating Range	50°F – 115°F

Rated Cooling Conditions: Indoor: 80°F DB/67°F WB  
Outdoor: 95°F DB/75°F WB

Heating (Btu/hr)	
1: @ 47° Rated (Min/Max)	9,400 (4,400 – 13,600)
2: @ 17° Rated	5,800
3: @ 5°	4,603
Operating Range	5°F – 65°F

1: Rated Heating Conditions: Indoor: 70°F DB/60°F WB  
Outdoor: 47°F DB/43°F WB  
2: Rated Heating Conditions: Indoor: 70°F DB/60°F WB  
Outdoor: 17°F DB/15°F WB  
3: Heating Conditions: Indoor: 69.8°F DB  
Outdoor: 5°F WB

### Electrical

	208/60/1	230/60/1
System MCA	6.95	6.95
System MFA	15	15
Compressor RLA	6.75	6.75
Outdoor fan motor FLA	.19	.19
Outdoor fan motor W	41	41
Indoor fan motor FLA	.20	.20
Indoor fan motor W	18	18

MFA: Max. fuse amps MCA: Min. circuit amps (A) FLA: Full load amps (A)  
RLA: Rated load amps (A) W: Fan motor rated output (W)

### Piping

Liquid (in)	1/4
Gas (in)	3/8
Drain (in)	3/4
Max. Interunit Piping Length (ft)	65.625
Max. Interunit Height Difference (ft)	32.8
Chargeless (ft)	24.6
Additional Charge of Refrigerant (oz/ft)	.21

Daikin North America LLC San Felipe, Suite 500 Houston, TX 77056

(Daikin's products are subject to continuous improvements. Daikin reserves the right to modify product design, specifications and information in this data sheet without notice and without incurring any obligations)

# FTXB09AXVJU Dimensional Data

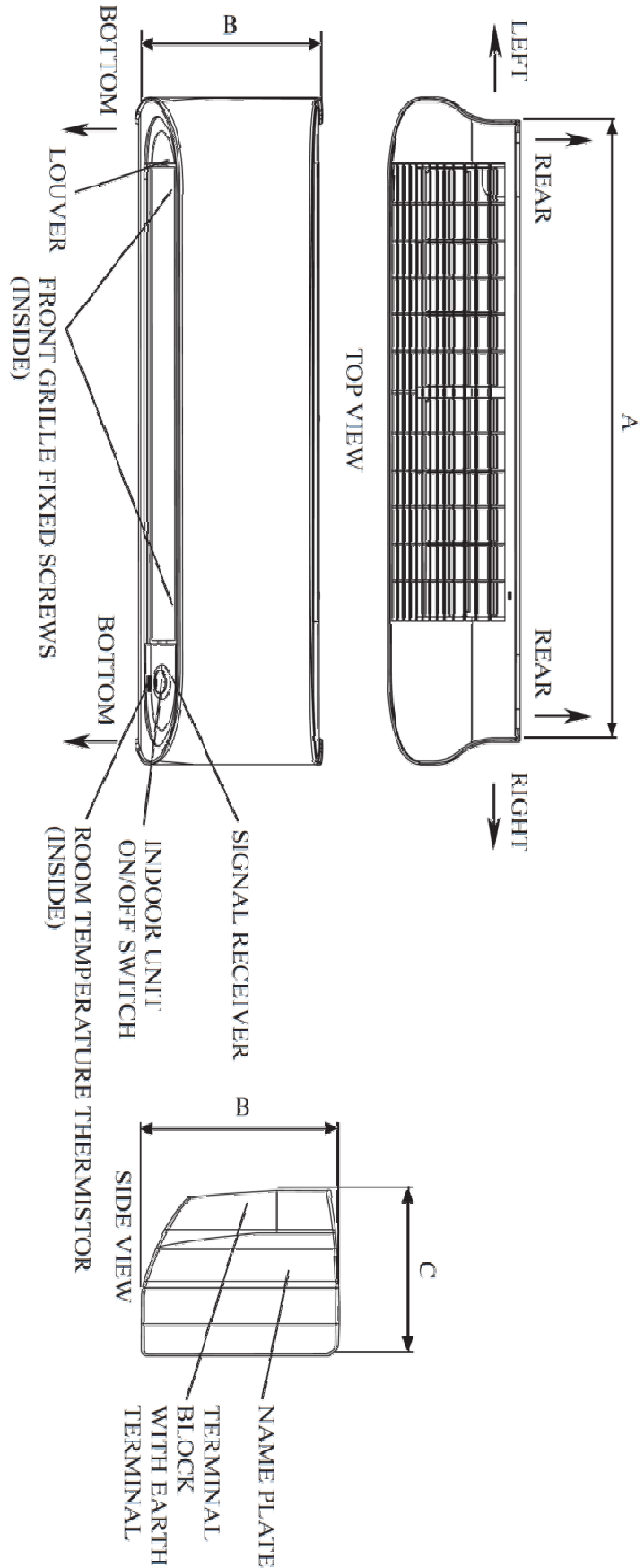

Model	Dimension		
<b>09/12</b>	<b>A</b> 35-1/16 (890)	<b>B</b> 11-11/16 (297)	<b>C</b> 8-1/4 (210)

Daikin North America LLC San Felipe, Suite 500 Houston, TX 77056

(Daikin's products are subject to continuous improvements. Daikin reserves the right to modify product design, specifications and information in this data sheet without notice and without incurring any obligations)

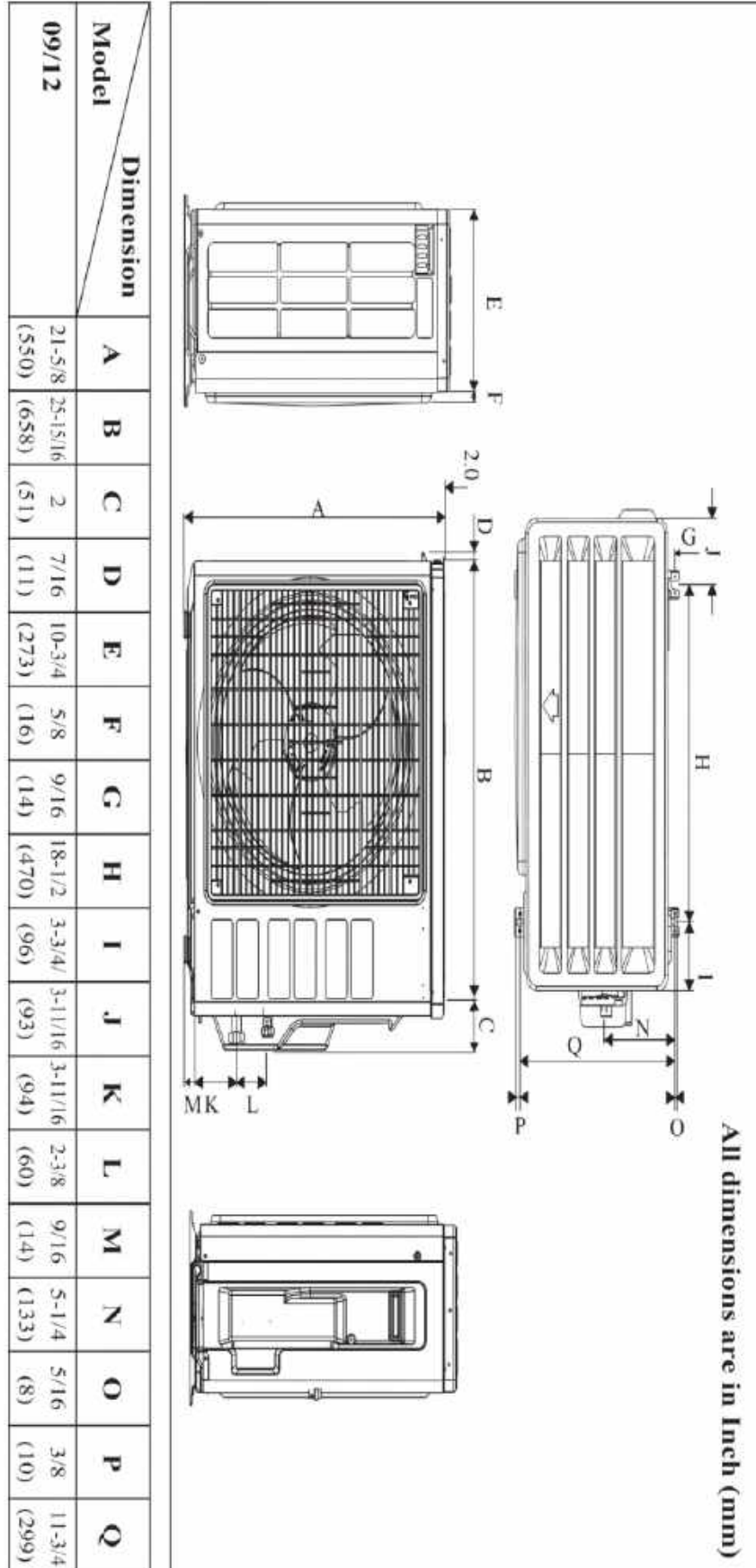

Daikin North America LLC San Felipe, Suite 500 Houston, TX 77056

(Daikin's products are subject to continuous improvements. Daikin reserves the right to modify product design, specifications and information in this data sheet without notice and without incurring any obligations)



Cooling Mode

AFR (CFM)	EWB	EDB	Outdoor temperature																	
			66.2°F			77.0°F			86.0°F			95.0°F			104.0°F			114.8°F		
			TC	SC	PI	TC	SC	PI	TC	SC	PI	TC	SC	PI	TC	SC	PI	TC	SC	PI
215	61.6°F	69.2°F	8294	6258	0.61	8001	6094	0.66	7703	5930	0.71	7394	5760	0.77	6790	5360	0.84	6269	5042	0.92
		74.6°F	8305	7493	0.61	8010	7322	0.66	7714	7151	0.71	7405	6974	0.77	6803	6513	0.84	6293	6145	0.92
		80.0°F	8371	8371	0.61	8092	8092	0.66	7808	7808	0.71	7514	7514	0.77	6933	6933	0.84	6450	6450	0.93
		85.4°F	8628	8628	0.61	8381	8381	0.66	8127	8127	0.72	7865	7865	0.78	7290	7290	0.85	6821	6821	0.94
	67.0°F	74.6°F	9149	5842	0.62	8828	5694	0.67	8504	5543	0.72	8167	5386	0.79	7506	5017	0.85	6939	4724	0.94
		80.0°F	9155	6684	0.62	8832	6534	0.67	8509	6384	0.72	8174	6230	0.79	7513	5827	0.85	6948	5520	0.94
		85.4°F	9169	8249	0.62	8852	8073	0.67	8539	7894	0.72	8216	7704	0.79	7564	7205	0.85	7018	6818	0.94
		90.8°F	9278	9278	0.62	8976	8976	0.67	8685	8685	0.73	8388	8388	0.79	7761	7761	0.86	7256	7256	0.95
	72.4°F	80.0°F	10065	5718	0.63	9717	5580	0.68	9362	5440	0.74	8997	5291	0.80	8273	4930	0.87	7658	4648	0.96
		85.4°F	10068	6969	0.63	9720	6820	0.68	9364	6665	0.74	8998	6507	0.80	8276	6091	0.87	7661	5776	0.96
		90.8°F	10074	8139	0.63	9725	7984	0.68	9371	7825	0.74	9005	7664	0.80	8286	7194	0.87	7680	6834	0.96
		96.2°F	10106	9229	0.63	9773	9044	0.68	9433	8856	0.74	9090	8661	0.80	8383	8120	0.87	7794	7703	0.96
272	61.6°F	69.2°F	8632	6529	0.61	8320	6361	0.66	8005	6192	0.72	7678	6017	0.78	7045	5603	0.84	6499	5273	0.93
		74.6°F	8658	7925	0.61	8347	7740	0.66	8034	7552	0.72	7710	7365	0.78	7083	6871	0.84	6547	6485	0.93
		80.0°F	8762	8762	0.62	8468	8468	0.67	8176	8176	0.72	7882	7882	0.78	7277	7277	0.85	6779	6779	0.94
		85.4°F	9128	9128	0.62	8863	8863	0.67	8593	8593	0.73	8314	8314	0.79	7703	7703	0.86	7200	7200	0.95
	67.0°F	74.6°F	9510	6177	0.62	9171	6022	0.67	8827	5865	0.73	8472	5704	0.79	7780	5315	0.86	7187	5010	0.95
		80.0°F	9526	7115	0.62	9186	6958	0.67	8843	6800	0.73	8488	6639	0.79	7799	6206	0.86	7210	5876	0.95
		85.4°F	9572	8777	0.62	9239	8587	0.68	8908	8395	0.73	8567	8190	0.79	7888	7657	0.86	7319	7234	0.95
		90.8°F	9731	9731	0.63	9435	9435	0.68	9134	9134	0.74	8831	8831	0.80	8180	8180	0.87	7648	7648	0.96
	72.4°F	80.0°F	10449	6048	0.63	10081	5906	0.69	9706	5757	0.75	9320	5601	0.81	8565	5224	0.88	7922	4929	0.97
		85.4°F	10462	7421	0.63	10093	7268	0.69	9717	7105	0.75	9331	6940	0.81	8576	6500	0.88	7933	6168	0.97
		90.8°F	10480	8696	0.64	10116	8530	0.69	9745	8356	0.75	9361	8178	0.81	8612	7671	0.88	7983	7283	0.97
		96.2°F	10545	9831	0.64	10205	9645	0.69	9848	9444	0.75	9490	9224	0.81	8755	8632	0.88	8163	8143	0.97
330	61.6°F	69.2°F	8952	6814	0.62	8624	6641	0.67	8293	6466	0.72	7949	6285	0.78	7291	5854	0.85	6721	5509	0.94
		74.6°F	8999	8280	0.62	8672	8084	0.67	8346	7886	0.73	8009	7679	0.79	7355	7166	0.85	6795	6756	0.94
		80.0°F	9144	9144	0.62	8845	8845	0.67	8546	8546	0.73	8240	8240	0.79	7614	7614	0.86	7096	7096	0.95
		85.4°F	9602	9602	0.63	9321	9321	0.68	9034	9034	0.74	8737	8737	0.80	8090	8090	0.87	7555	7555	0.96
	67.0°F	74.6°F	9853	6536	0.63	9497	6375	0.68	9136	6211	0.74	8764	6043	0.80	8043	5634	0.87	7426	5314	0.95
		80.0°F	9882	7562	0.63	9527	7389	0.68	9169	7216	0.74	8800	7040	0.80	8080	6584	0.87	7467	6229	0.96
		85.4°F	9964	9306	0.63	9612	9103	0.68	9267	8895	0.74	8912	8672	0.80	8206	8100	0.87	7617	7617	0.96
		90.8°F	10180	10180	0.63	9882	9882	0.69	9578	9578	0.74	9262	9262	0.81	8580	8580	0.88	8025	8025	0.97
	72.4°F	80.0°F	10812	6394	0.64	10428	6254	0.69	10036	6097	0.75	9632	5937	0.82	8847	5540	0.88	8177	5231	0.97
		85.4°F	10835	7883	0.64	10449	7734	0.69	10056	7565	0.75	9652	7393	0.82	8868	6923	0.88	8202	6563	0.97
		90.8°F	10872	9238	0.64	10496	9077	0.69	10110	8886	0.75	9713	8690	0.82	8936	8145	0.89	8278	7730	0.98
		96.2°F	10969	10431	0.64	10626	10241	0.70	10258	10017	0.76	9889	9768	0.82	9137	9111	0.89	8524	8524	0.98

Heating Mode

Indoor DB°F	Outdoor WB°F											
	5.0		14.0		23.0		32.0		42.8		50.0	
	TC	PI	TC	PI	TC	PI	TC	PI	TC	PI	TC	PI
60.8	4716	0.56	5851	0.60	6985	0.63	8136	0.67	9497	0.72	10405	0.75
64.4	4668	0.58	5802	0.62	6953	0.66	8087	0.70	9449	0.75	10356	0.78
68.0	4619	0.61	5753	0.65	6904	0.69	8039	0.73	9400	0.77	10308	0.81
69.8	4603	0.62	5737	0.66	6872	0.70	8006	0.74	9384	0.79	10291	0.82
71.6	4570	0.64	5721	0.68	6856	0.71	7990	0.76	9351	0.80	10259	0.83
75.2	4522	0.67	5672	0.71	6807	0.75	7941	0.78	9303	0.83	10210	0.86

Remark:

- AFR: Air flow rate (CFM)
- EWB: Entering Wet Bulb Temp. (°F)
- EDB: Entering Dry Bulb Temp. (°F)
- TC: Total Cooling Capacity (Btu/h)
- SC: Sensible Cooling Capacity (Btu/h)
- PI: Power Input (kW)

Notes:

1. Ratings shown are net capacities.
2.  Shows nominal capacities.
3. Direct interpolation is permissible. Do not extrapolate.

Job Name:	
Tag#	



<b>Submittal Data Sheet</b>	<b>FTXB12AXVJU / RXB12AXVJU</b>
1.0-Ton Wall Mounted Heat Pump System	



Complete warranty details available from your local dealer or at [www.daikincomfort.com](http://www.daikincomfort.com). To receive the 10-Year Parts Limited Warranty, online registration must be completed within 60 days of installation. Online registration is not required in California or Quebec. *If product is installed in a commercial application, limited warranty period is 5 years.*

### Indoor Specifications

	Cooling		Heating	
	H	M	H	M
Airflow Rate (cfm)	360	282	360	282
	L		L	
	232		232	
Sound (dBA) H / M / L	42 / 35 / 30		42 / 35 / 30	
Dimensions (H x W x D) (in)	11-11/16 x 35-1/16 x 8-1/4			
Weight (Lbs)	20			

### Outdoor Specifications

Compressor	Hermetically Sealed Swing Type			
Refrigerant	R-410A			
Factory Charge (Lbs)	2.20			
Refrigerant Oil	PVE (FVC50K)			
Airflow Rate (cfm)	Cooling		Heating	
	H	730	H	730
Sound Pressure Level (dBA)	48			
Dimensions (H x W x D) (in)	21-5/8 x 25-15/16 x 10-3/4			
Weight (Lbs)	57			

### Efficiency

Cooling		Heating	
SEER	17	HSPF	9
EER	8.5	COP	3.3

### Performance

Cooling (Btu/hr)	
Rated (Min/Max)	11,000 (4,400 – 16,200)
Sensible @ AHRI	8,394
Operating Range	50°F – 115°F

**Rated Cooling Conditions:** Indoor: 80°F DB/67°F WB  
Outdoor: 95°F DB/75°F WB

Heating (Btu/hr)	
1: @ 47° Rated (Min/Max)	11,300 (4,400 – 16,200)
2: @ 17° Rated	7,200
3: @ 5°	5,533
Operating Range	5°F – 65°F

**1: Rated Heating Conditions:** Indoor: 70°F DB/60°F WB  
Outdoor: 47°F DB/43°F WB  
**2: Rated Heating Conditions:** Indoor: 70°F DB/60°F WB  
Outdoor: 17°F DB/15°F WB  
**3. Heating Conitions:** Indoor: 69.8°F DB  
Outdoor: 5°F WB

### Electrical

	208/60/1	230/60/1
System MCA	7.95	7.95
System MFA	15	15
Compressor RLA	7.75	7.75
Outdoor fan motor FLA	.19	.19
Outdoor fan motor W	41	41
Indoor fan motor FLA	.20	.20
Indoor fan motor W	18	18

**MFA:** Max. fuse amps **MCA:** Min. circuit amps (A) **FLA:** Full load amps (A)  
**RLA:** Rated load amps (A) **W:** Fan motor rated output (W)

### Piping

Liquid (in)	1/4
Gas (in)	3/8
Drain (in)	3/4
Max. Interunit Piping Length (ft)	65.625
Max. Interunit Height Difference (ft)	32.8
Chargeless (ft)	24.6
Additional Charge of Refrigerant (oz/ft)	.21

Daikin North America LLC San Felipe, Suite 500 Houston, TX 77056

(Daikin's products are subject to continuous improvements. Daikin reserves the right to modify product design, specifications and information in this data sheet without notice and without incurring any obligations)

# FTXB12AXVJU Dimensional Data

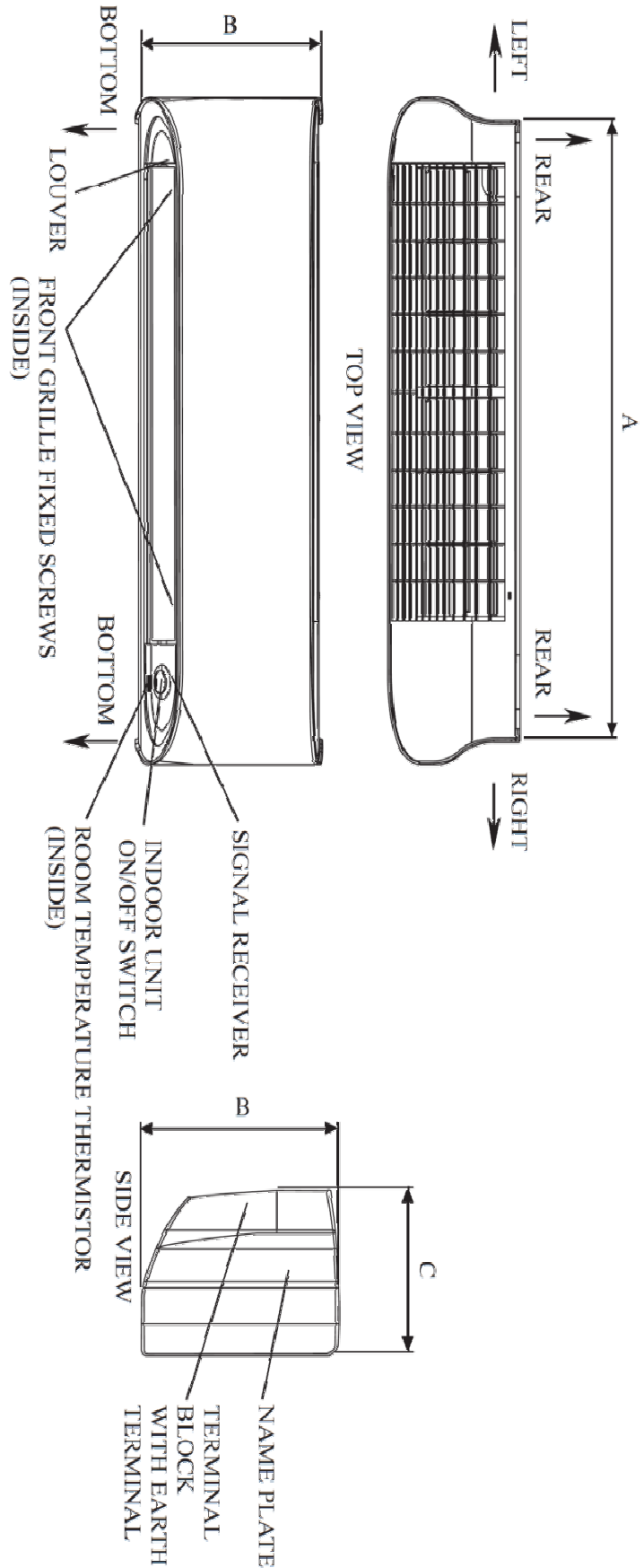

Model	Dimension		
<b>09/12</b>	<b>A</b> 35-1/16 (890)	<b>B</b> 11-11/16 (297)	<b>C</b> 8-1/4 (210)

Daikin North America LLC San Felipe, Suite 500 Houston, TX 77056

(Daikin's products are subject to continuous improvements. Daikin reserves the right to modify product design, specifications and information in this data sheet without notice and without incurring any obligations)

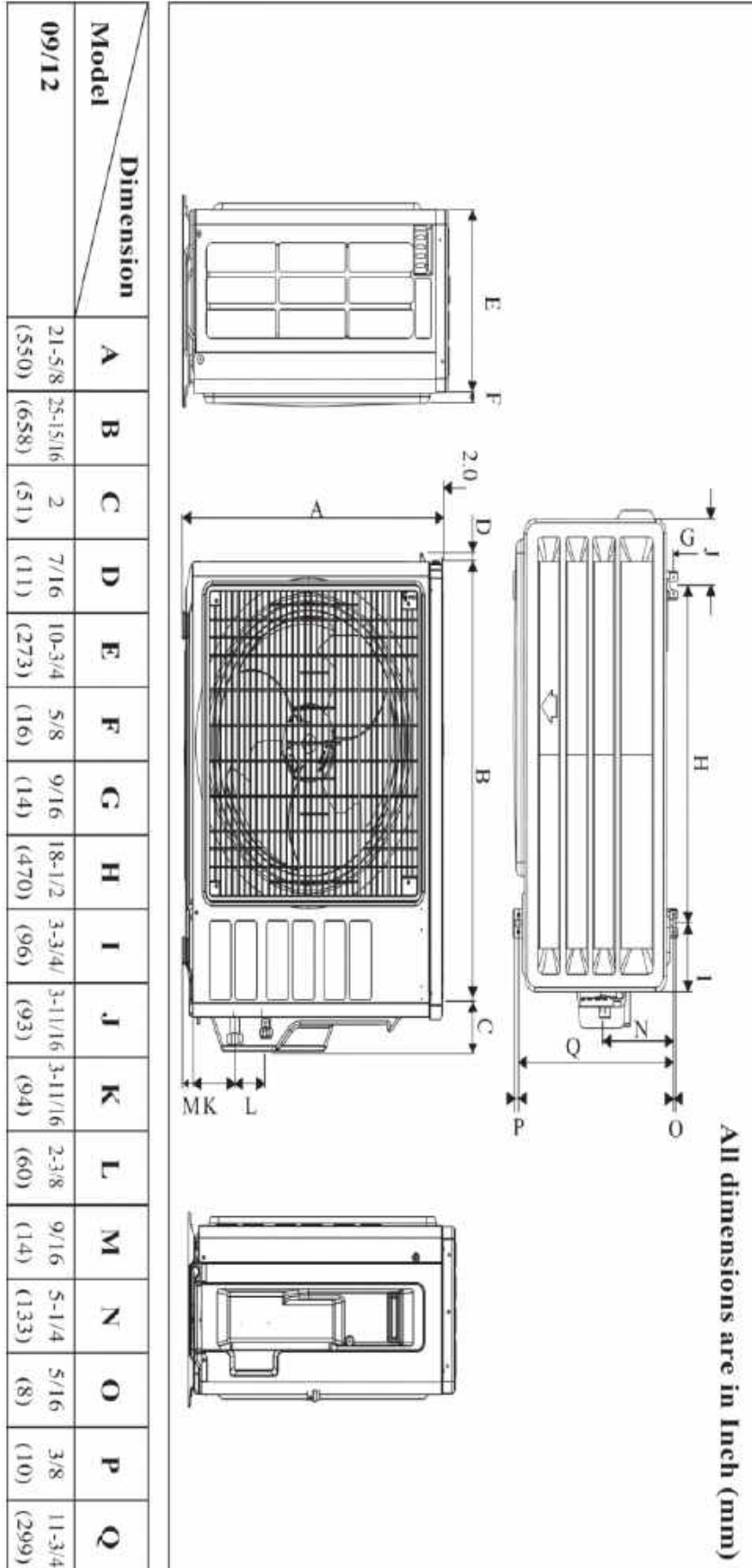

Daikin North America LLC San Felipe, Suite 500 Houston, TX 77056

(Daikin's products are subject to continuous improvements. Daikin reserves the right to modify product design, specifications and information in this data sheet without notice and without incurring any obligations)



## Cooling Mode

AFR (CFM)	EWB	EDB	Outdoor temperature																	
			66.2°F			77.0°F			86.0°F			95.0°F			104.0°F			114.8°F		
			TC	SC	PI	TC	SC	PI	TC	SC	PI	TC	SC	PI	TC	SC	PI	TC	SC	PI
232	61.6°F	69.2°F	10368	7040	0.98	10002	6856	1.06	9630	6672	1.15	9243	6480	1.25	8488	6031	1.35	7836	5673	1.49
		74.6°F	10382	8430	0.98	10014	8237	1.06	9643	8046	1.15	9257	7846	1.25	8505	7327	1.36	7867	6914	1.49
		80.0°F	10464	9558	0.98	10116	9341	1.07	9760	9121	1.15	9393	8888	1.25	8667	8271	1.36	8064	7767	1.50
		85.4°F	10786	10786	0.99	10476	10476	1.07	10159	10159	1.16	9832	9832	1.26	9114	9114	1.37	8526	8526	1.51
	67.0°F	74.6°F	11437	6573	1.00	11035	6406	1.08	10630	6236	1.17	10210	6060	1.27	9383	5644	1.38	8674	5315	1.52
		80.0°F	11444	7520	1.00	11041	7351	1.08	10637	7183	1.17	10218	7009	1.27	9392	6556	1.38	8685	6211	1.52
		85.4°F	11462	9280	1.00	11066	9082	1.08	10675	8881	1.17	10270	8667	1.27	9456	8106	1.38	8773	7670	1.52
		90.8°F	11598	11598	1.00	11220	11220	1.08	10856	10856	1.18	10486	10486	1.28	9702	9702	1.39	9070	9070	1.53
	72.4°F	80.0°F	12582	6433	1.02	12146	6278	1.10	11704	6120	1.19	11246	5952	1.30	10342	5547	1.40	9573	5229	1.55
		85.4°F	12586	7840	1.02	12151	7673	1.10	11706	7499	1.19	11249	7321	1.30	10345	6853	1.41	9577	6499	1.55
		90.8°F	12593	9156	1.02	12157	8982	1.10	11714	8804	1.19	11257	8622	1.30	10358	8094	1.41	9601	7689	1.55
		96.2°F	12634	10383	1.02	12216	10175	1.10	11792	9964	1.20	11363	9743	1.30	10479	9135	1.41	9743	8667	1.55
282	61.6°F	69.2°F	10790	7345	0.99	10401	7156	1.07	10006	6966	1.16	9598	6769	1.26	8807	6303	1.37	8124	5932	1.51
		74.6°F	10823	8916	0.99	10433	8707	1.07	10043	8499	1.16	9638	8285	1.26	8854	7729	1.37	8184	7295	1.51
		80.0°F	10953	10126	0.99	10585	9890	1.08	10220	9636	1.17	9853	9349	1.27	9096	8684	1.37	8474	8123	1.52
		85.4°F	11409	11409	1.00	11079	11079	1.09	10742	10742	1.18	10393	10393	1.28	9629	9629	1.39	9001	9001	1.53
	67.0°F	74.6°F	11887	6949	1.01	11463	6774	1.09	11034	6598	1.18	10590	6416	1.28	9725	5979	1.39	8984	5636	1.53
		80.0°F	11908	8004	1.01	11483	7827	1.09	11054	7650	1.18	10610	7468	1.28	9748	6982	1.39	9012	6610	1.53
		85.4°F	11965	9874	1.01	11549	9660	1.09	11135	9444	1.18	10709	9213	1.29	9860	8614	1.39	9148	8138	1.54
		90.8°F	12164	12164	1.01	11794	11794	1.10	11418	11418	1.19	11039	11039	1.29	10225	10225	1.40	9560	9560	1.55
	72.4°F	80.0°F	13061	6803	1.03	12601	6644	1.11	12133	6476	1.21	11650	6301	1.31	10706	5877	1.42	9903	5545	1.56
		85.4°F	13077	8349	1.03	12616	8176	1.11	12146	7993	1.21	11664	7807	1.31	10720	7312	1.42	9917	6939	1.56
		90.8°F	13101	9783	1.03	12645	9596	1.11	12181	9400	1.21	11702	9200	1.31	10765	8630	1.42	9978	8193	1.56
		96.2°F	13181	11059	1.03	12756	10850	1.12	12310	10624	1.21	11863	10377	1.31	10944	9710	1.42	10204	9160	1.57
360	61.6°F	69.2°F	11191	7667	1.00	10781	7472	1.08	10367	7275	1.17	9937	7072	1.27	9114	6586	1.38	8402	6199	1.52
		74.6°F	11250	9316	1.00	10841	9095	1.08	10433	8872	1.17	10012	8639	1.27	9195	8062	1.38	8494	7602	1.52
		80.0°F	11431	10676	1.00	11057	10400	1.09	10684	10109	1.18	10300	9797	1.28	9519	9075	1.39	8870	8473	1.53
		85.4°F	12003	12003	1.01	11652	11652	1.10	11293	11293	1.19	10922	10922	1.29	10113	10113	1.40	9445	9445	1.55
	67.0°F	74.6°F	12318	7354	1.02	11872	7172	1.10	11421	6988	1.19	10956	6799	1.29	10055	6338	1.40	9283	5978	1.54
		80.0°F	12354	8508	1.02	11910	8314	1.10	11462	8119	1.19	11000	7920	1.29	10100	7407	1.40	9335	7008	1.55
		85.4°F	12456	10470	1.02	12015	10242	1.10	11585	10008	1.20	11141	9757	1.30	10258	9113	1.41	9522	8589	1.55
		90.8°F	12726	12726	1.02	12354	12354	1.11	11973	11973	1.20	11578	11578	1.31	10726	10726	1.42	10031	10031	1.57
	72.4°F	80.0°F	13516	7194	1.04	13036	7036	1.12	12546	6859	1.22	12041	6679	1.32	11060	6233	1.43	10222	5885	1.57
		85.4°F	13544	8869	1.04	13062	8701	1.12	12571	8511	1.22	12066	8318	1.32	11086	7789	1.43	10253	7384	1.58
		90.8°F	13591	10393	1.04	13121	10212	1.12	12639	9997	1.22	12142	9777	1.32	11171	9164	1.43	10349	8697	1.58
		96.2°F	13712	11735	1.04	13283	11522	1.13	12823	11270	1.22	12362	10990	1.33	11422	10251	1.44	10655	9651	1.59

## Heating Mode

Indoor DB°F	Outdoor WB°F											
	5.0		14.0		23.0		32.0		42.8		50.0	
	TC	PI	TC	PI	TC	PI	TC	PI	TC	PI	TC	PI
60.8	5669	0.72	7033	0.77	8397	0.82	9780	0.87	11417	0.93	12508	0.97
64.4	5611	0.76	6975	0.81	8358	0.86	9722	0.91	11358	0.97	12449	1.01
68.0	5553	0.79	6916	0.84	8300	0.89	9663	0.94	11300	1.00	12391	1.05
69.8	5533	0.81	6897	0.86	8261	0.91	9624	0.96	11280	1.02	12371	1.06
71.6	5494	0.83	6877	0.88	8241	0.93	9605	0.98	11241	1.04	12332	1.08
75.2	5436	0.87	6819	0.92	8183	0.97	9546	1.02	11183	1.07	12274	1.12

Remark:

- AFR: Air flow rate (CFM)
- EWB: Entering Wet Bulb Temp. (°F)
- EDB: Entering Dry Bulb Temp. (°F)
- TC: Total Cooling Capacity (Btu/h)
- SC: Sensible Cooling Capacity (Btu/h)
- PI: Power Input (kW)

Notes:

1. Ratings shown are net capacities.
2.  Shows nominal capacities.
3. Direct interpolation is permissible. Do not extrapolate.



Job Name:	
Tag#	



<b>Submittal Data Sheet</b>	<b>FTXB18AXVJU / RXB18AXVJU</b>
1.5-Ton Wall Mounted Heat Pump System	



Complete warranty details available from your local dealer or at [www.daikincomfort.com](http://www.daikincomfort.com). To receive the 10-Year Parts Limited Warranty, online registration must be completed within 60 days of installation. Online registration is not required in California or Quebec. *If product is installed in a commercial application, limited warranty period is 5 years.*

### Indoor Specifications

	Cooling		Heating	
	H	M	H	M
Airflow Rate (cfm)	430	374	435	374
	L		L	
	318		318	
Sound (dBA) H / M / L	40 / 37 / 35		40 / 37 / 35	
Dimensions (H x W x D) (in)	12-5/8 x 46-1/8 x 9-1/2			
Weight (Lbs)	31			

### Outdoor Specifications

Compressor	Hermetically Sealed Swing Type			
Refrigerant	R-410A			
Factory Charge (Lbs)	2.75			
Refrigerant Oil	PVE (FVC50K)			
Airflow Rate (cfm)	Cooling		Heating	
	H	1690	H	1690
Sound Pressure Level (dBA)	53			
Dimensions (H x W x D) (in)	25-11/16 x 33-11/16 x 12-15/16			
Weight (Lbs)	82			

### Efficiency

Cooling		Heating	
SEER	17	HSPF	9
EER	10.5	COP	3.3

### Performance

Cooling (Btu/hr)	
Rated (Min/Max)	18,000 (4,300 – 21,200)
Sensible @ AHRI	12,864
Operating Range	50°F – 115°F

Rated Cooling Conditions: Indoor: 80°F DB/67°F WB  
Outdoor: 95°F DB/75°F WB

Heating (Btu/hr)	
1: @ 47° Rated (Min/Max)	17,900 (4,000 – 22,500)
2: @ 17° Rated	10,200
3: @ 5°	8,765
Operating Range	5°F – 65°F

1: Rated Heating Conditions: Indoor: 70°F DB/60°F WB  
Outdoor: 47°F DB/43°F WB  
2: Rated Heating Conditions: Indoor: 70°F DB/60°F WB  
Outdoor: 17°F DB/15°F WB  
3: Heating Conditions: Indoor: 69.8°F DB  
Outdoor: 5°F WB

### Electrical

	208/60/1	230/60/1
System MCA	16.2	16.2
System MFA	20	20
Compressor RLA	16	16
Outdoor fan motor FLA	.50	.50
Outdoor fan motor W	61	61
Indoor fan motor FLA	.24	.24
Indoor fan motor W	40	40

MFA: Max. fuse amps MCA: Min. circuit amps (A) FLA: Full load amps (A)  
RLA: Rated load amps (A) W: Fan motor rated output (W)

### Piping

Liquid (in)	1/4
Gas (in)	1/2
Drain (in)	3/4
Max. Interunit Piping Length (ft)	98.4
Max. Interunit Height Difference (ft)	32.8
Chargeless (ft)	24.6
Additional Charge of Refrigerant (oz/ft)	.21

Daikin North America LLC San Felipe, Suite 500 Houston, TX 77056

(Daikin's products are subject to continuous improvements. Daikin reserves the right to modify product design, specifications and information in this data sheet without notice and without incurring any obligations)

# FTXB18AXVJU Dimensional Data

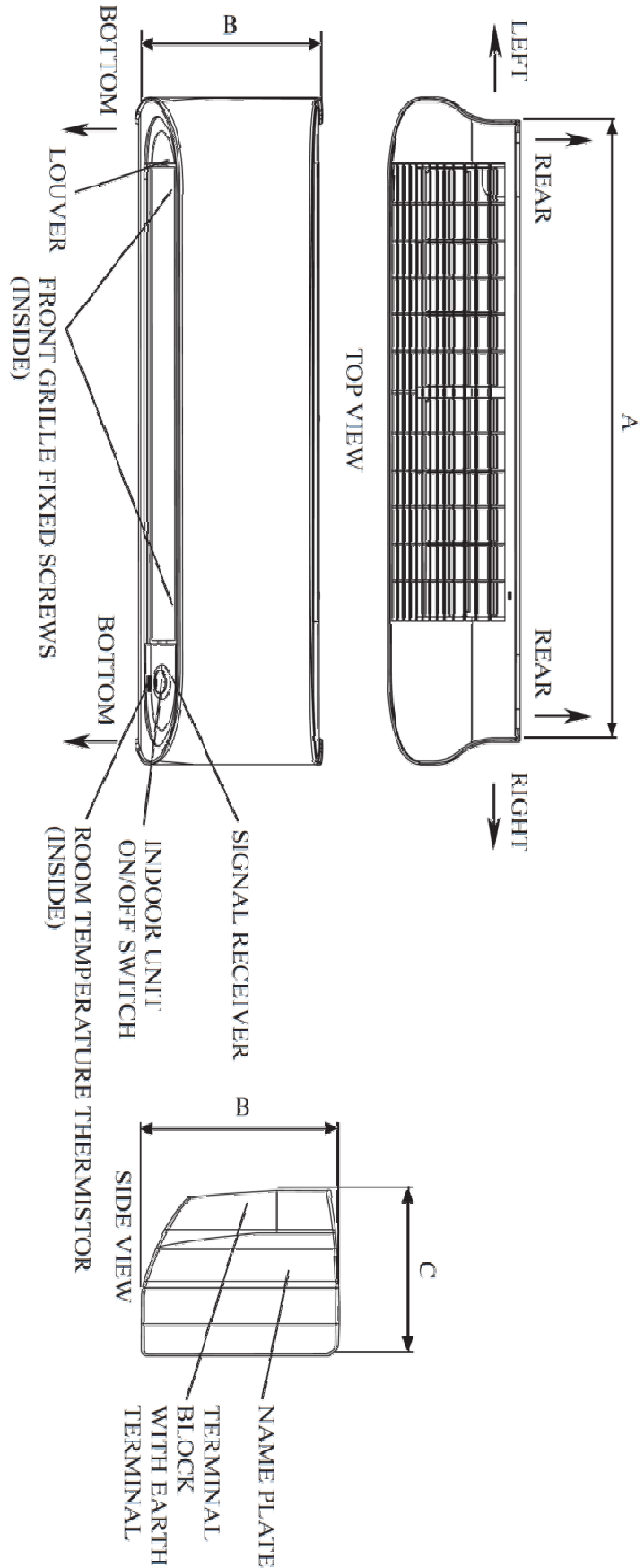

Model	Dimension		
18/24	A	B	C
	46-1/8 (1172)	12-5/8 (320)	9-1/2 (242)

Daikin North America LLC San Felipe, Suite 500 Houston, TX 77056

(Daikin's products are subject to continuous improvements. Daikin reserves the right to modify product design, specifications and information in this data sheet without notice and without incurring any obligations)

# RXB18AXVJU Dimensional Data

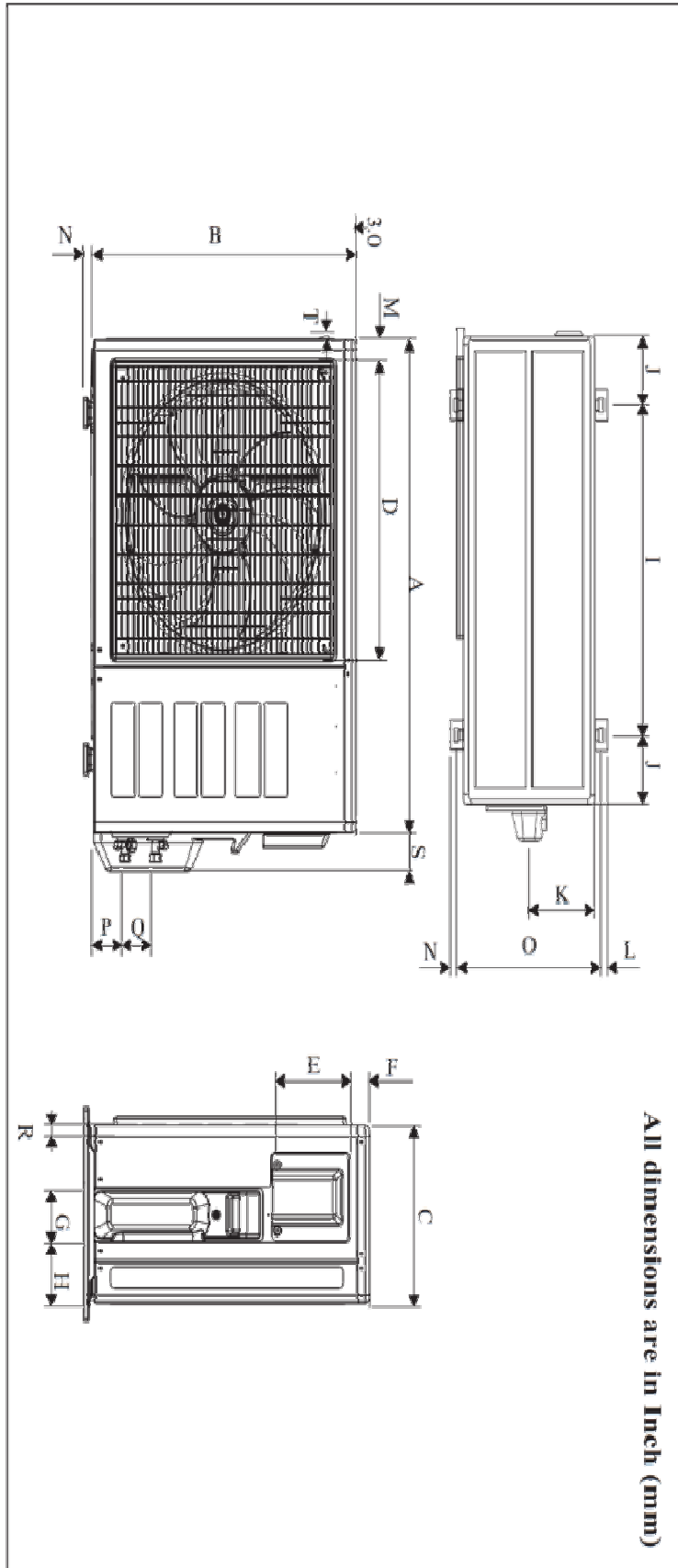

All dimensions are in Inch (mm)

Model	A	B	C	D	E	F	G	H	I	J	K	L	M	N	O
18	33-11/16 (855)	24-3/4 (628)	12-15/16 (328)	20-1/2 (520)	7-1/16 (179)	5-3/4 (46)	4 (101)	4-7/16 (113)	23-3/4 (603)	4-15/16 (126)	6-7/16 (164)	9/16 (15)	1-5/16 (34)	15/16 (23)	14-1/4 (362)
24	33-11/16 (855)	28-3/4 (730)	12-15/16 (328)	20-1/2 (520)	7-1/16 (179)	5-3/4 (46)	4 (101)	4-7/16 (113)	23-3/4 (603)	4-15/16 (126)	6-7/16 (164)	9/16 (15)	1-5/16 (34)	15/16 (23)	14-1/4 (362)
Dimension	P	Q	R	S	T										
18	2-7/8 (73)	2-15/16 (75)	5/16 (8)	2-5/8 (67)	1/4 (7)										
24	2-7/8 (73)	2-15/16 (75)	5/16 (8)	2-5/8 (67)	1/4 (7)										

Daikin North America LLC San Felipe, Suite 500 Houston, TX 77056

(Daikin's products are subject to continuous improvements. Daikin reserves the right to modify product design, specifications and information in this data sheet without notice and without incurring any obligations)

# FTXB18AXVJU / RXB18AXVJU Performance Tables



## Cooling Mode

AFR (CFM)	EWB	EDB	Outdoor temperature																	
			66.2°F			77.0°F			86.0°F			95.0°F			104.0°F			114.8°F		
			TC	SC	PI	TC	SC	PI	TC	SC	PI	TC	SC	PI	TC	SC	PI	TC	SC	PI
318	61.6°F	69.2°F	16971	11207	1.30	16371	10914	1.41	15762	10620	1.52	15130	10316	1.65	13893	9600	1.79	12826	9030	1.97
		74.6°F	16994	13419	1.30	16390	13112	1.41	15783	12807	1.52	15152	12489	1.65	13921	11664	1.79	12876	11005	1.97
		80.0°F	17128	15215	1.30	16558	14869	1.41	15976	14518	1.53	15374	14147	1.65	14186	13165	1.80	13198	12364	1.98
		85.4°F	17655	17655	1.31	17148	17148	1.42	16628	16628	1.54	16093	16093	1.67	14917	14917	1.81	13956	13956	2.00
	67.0°F	74.6°F	18719	10463	1.32	18063	10198	1.43	17400	9926	1.55	16711	9646	1.68	15358	8984	1.82	14198	8460	2.01
		80.0°F	18732	11971	1.32	18072	11701	1.43	17411	11433	1.55	16725	11156	1.68	15373	10436	1.82	14216	9886	2.01
		85.4°F	18761	14772	1.32	18113	14457	1.43	17473	14137	1.55	16810	13797	1.68	15478	12902	1.82	14359	12210	2.01
		90.8°F	18983	18983	1.32	18365	18365	1.43	17770	17770	1.55	17164	17164	1.69	15881	15881	1.83	14847	14847	2.02
	72.4°F	80.0°F	20594	10241	1.34	19881	9993	1.46	19157	9743	1.58	18408	9475	1.71	16927	8829	1.86	15669	8324	2.05
		85.4°F	20601	12480	1.34	19889	12214	1.46	19160	11937	1.58	18412	11653	1.71	16933	10908	1.86	15675	10344	2.05
		90.8°F	20612	14575	1.34	19899	14298	1.46	19174	14014	1.58	18425	13724	1.71	16955	12884	1.86	15714	12239	2.05
		96.2°F	20679	16528	1.35	19996	16197	1.46	19302	15860	1.58	18600	15510	1.72	17152	14541	1.86	15948	13796	2.05
374	61.6°F	69.2°F	17659	11688	1.31	17021	11387	1.42	16376	11084	1.54	15707	10772	1.66	14412	10030	1.81	13296	9440	1.99
		74.6°F	17712	14187	1.31	17075	13855	1.42	16436	13524	1.54	15772	13184	1.67	14490	12300	1.81	13394	11608	1.99
		80.0°F	17925	16114	1.31	17323	15738	1.42	16725	15334	1.54	16125	14877	1.67	14886	13818	1.82	13869	12926	2.00
		85.4°F	18672	18672	1.32	18132	18132	1.43	17579	17579	1.56	17008	17008	1.69	15759	15759	1.83	14730	14730	2.03
	67.0°F	74.6°F	19454	11058	1.33	18761	10780	1.44	18058	10499	1.56	17331	10210	1.69	15916	9514	1.84	14704	8968	2.02
		80.0°F	19488	12736	1.33	18793	12455	1.44	18090	12173	1.56	17364	11884	1.70	15954	11110	1.84	14749	10519	2.03
		85.4°F	19501	15712	1.33	18900	15272	1.44	18223	15028	1.57	17527	14660	1.70	16137	13708	1.84	14972	12950	2.03
		90.8°F	19908	19908	1.34	19301	19301	1.45	18686	18686	1.57	18066	18066	1.71	16734	16734	1.86	15645	15645	2.05
	72.4°F	80.0°F	21375	10826	1.36	20623	10572	1.47	19856	10305	1.59	19067	10027	1.73	17521	9352	1.87	16206	8824	2.06
		85.4°F	21401	13285	1.36	20647	13010	1.47	19877	12720	1.59	19089	12423	1.73	17544	11635	1.87	16229	11041	2.06
		90.8°F	21440	15568	1.36	20695	15270	1.47	19935	14959	1.60	19150	14640	1.73	17618	13732	1.88	16330	13038	2.07
		96.2°F	21572	17598	1.36	20876	17265	1.47	20146	16906	1.60	19414	16512	1.74	17911	15452	1.88	16699	14577	2.08
430	61.6°F	69.2°F	18313	12197	1.32	17641	11887	1.43	16964	11574	1.55	16261	11250	1.68	14914	10478	1.82	13748	9861	2.01
		74.6°F	18409	14821	1.32	17739	14469	1.43	17072	14115	1.55	16382	13744	1.68	15046	12826	1.82	13900	12093	2.01
		80.0°F	18705	16984	1.33	18093	16546	1.44	17482	16082	1.56	16855	15585	1.69	15576	14437	1.83	14514	13479	2.02
		85.4°F	19641	19641	1.34	19066	19066	1.45	18480	18480	1.57	17872	17872	1.71	16548	16548	1.86	15455	15455	2.05
	67.0°F	74.6°F	20156	11699	1.34	19427	11410	1.45	18688	11117	1.58	17928	10816	1.71	16453	10083	1.85	15190	9511	2.04
		80.0°F	20215	13535	1.34	19489	13226	1.46	18756	12916	1.58	18000	12600	1.71	16527	11784	1.85	15274	11148	2.04
		85.4°F	20382	16657	1.35	19661	16294	1.46	18957	15921	1.58	18230	15522	1.71	16785	14497	1.86	15582	13665	2.05
		90.8°F	20824	20824	1.35	20215	20215	1.47	19592	19592	1.59	18946	18946	1.73	17552	17552	1.88	16415	16415	2.07
	72.4°F	80.0°F	22117	11444	1.37	21331	11194	1.48	20529	10913	1.61	19703	10626	1.74	18098	9915	1.89	16726	9363	2.08
		85.4°F	22163	14109	1.37	21373	13842	1.48	20570	13540	1.61	19743	13233	1.74	18140	12391	1.89	16777	11747	2.08
		90.8°F	22240	16535	1.37	21471	16246	1.49	20681	15904	1.61	19868	15553	1.75	18279	14578	1.89	16934	13835	2.09
		96.2°F	22437	18670	1.37	21735	18330	1.49	20983	17929	1.62	20229	17484	1.75	18691	16308	1.90	17435	15353	2.10

## Heating Mode

Indoor DB°F	Outdoor WB°F											
	5.0		14.0		23.0		32.0		42.8		50.0	
	TC	PI	TC	PI	TC	PI	TC	PI	TC	PI	TC	PI
60.8	8981	1.14	11141	1.23	13302	1.30	15493	1.38	18086	1.48	19814	1.54
64.4	8888	1.20	11049	1.28	13240	1.36	15400	1.44	17993	1.53	19721	1.60
68.0	8796	1.25	10956	1.34	13148	1.41	15308	1.50	17900	1.59	19629	1.66
69.8	8765	1.28	10925	1.37	13086	1.44	15246	1.52	17870	1.62	19598	1.68
71.6	8703	1.31	10895	1.39	13055	1.47	15215	1.55	17808	1.65	19536	1.71
75.2	8611	1.37	10802	1.45	12962	1.53	15123	1.61	17715	1.70	19444	1.77

Remark:

- AFR: Air flow rate (CFM)
- EWB: Entering Wet Bulb Temp. (°F)
- EDB: Entering Dry Bulb Temp. (°F)
- TC: Total Cooling Capacity (Btu/h)
- SC: Sensible Cooling Capacity (Btu/h)
- PI: Power Input (kW)

Notes:

- Ratings shown are net capacities.
- Shows nominal capacities.
- Direct interpolation is permissible. Do not extrapolate.

Daikin North America LLC San Felipe, Suite 500 Houston, TX 77056

(Daikin's products are subject to continuous improvements. Daikin reserves the right to modify product design, specifications and information in this data sheet without notice and without incurring any obligations)

Job Name:	
Tag#	



## Submittal Data Sheet

## FTXB24AXVJU / RXB24AXVJU

### 2.0-Ton Wall Mounted Heat Pump System



Complete warranty details available from your local dealer or at [www.daikincomfort.com](http://www.daikincomfort.com). To receive the 10-Year Parts Limited Warranty, online registration must be completed within 60 days of installation. Online registration is not required in California or Quebec. *If product is installed in a commercial application, limited warranty period is 5 years.*

### Indoor Specifications

Airflow Rate (cfm)	Cooling		Heating	
	H	M	H	M
	555	486	580	486
Sound (dBA) H / M / L	L		L	
	405		405	
	47 / 44 / 41		47 / 44 / 41	
Dimensions (H x W x D) (in)	12-5/8 x 46-1/8 x 9-1/2			
Weight (Lbs)	31			

### Outdoor Specifications

Compressor	Hermetically Sealed Swing Type			
Refrigerant	R-410A			
Factory Charge (Lbs)	3.20			
Refrigerant Oil	PVE (FVC50K)			
Airflow Rate (cfm)	Cooling		Heating	
	H	1796	H	1796
Sound Pressure Level (dBA)	52			
Dimensions (H x W x D) (in)	29-11/16 x 33-11/16 x 12-15/16			
Weight (Lbs)	97			

### Efficiency

Cooling		Heating	
SEER	17	HSPF	9
EER	11	COP	3.68

### Performance

Cooling (Btu/hr)	
Rated (Min/Max)	21,200 (6,000 – 22,200)
Sensible @ AHRI	15,116
Operating Range	50°F – 115°F

Rated Cooling Conditions: Indoor: 80°F DB/67°F WB  
Outdoor: 95°F DB/75°F WB

Heating (Btu/hr)	
1: @ 47° Rated (Min/Max)	21,200 (4,100 – 27,300)
2: @ 17° Rated	11,800
3: @ 5°	10,381
Operating Range	5°F – 65°F

1: Rated Heating Conditions: Indoor: 70°F DB/60°F WB  
Outdoor: 47°F DB/43°F WB  
2: Rated Heating Conditions: Indoor: 70°F DB/60°F WB  
Outdoor: 17°F DB/15°F WB  
3: Heating Conditions: Indoor: 69.8°F DB  
Outdoor: 5°F WB

### Electrical

	208/60/1	230/60/1
System MCA	16.2	16.2
System MFA	20	20
Compressor RLA	16	16
Outdoor fan motor FLA	.50	.50
Outdoor fan motor W	61	61
Indoor fan motor FLA	.24	.24
Indoor fan motor W	40	40

MFA: Max. fuse amps MCA: Min. circuit amps (A) FLA: Full load amps (A)  
RLA: Rated load amps (A) W: Fan motor rated output (W)

### Piping

Liquid (in)	1/4
Gas (in)	5/8
Drain (in)	3/4
Max. Interunit Piping Length (ft)	98.4
Max. Interunit Height Difference (ft)	32.8
Chargeless (ft)	24.6
Additional Charge of Refrigerant (oz/ft)	.21

Daikin North America LLC San Felipe, Suite 500 Houston, TX 77056

(Daikin's products are subject to continuous improvements. Daikin reserves the right to modify product design, specifications and information in this data sheet without notice and without incurring any obligations)

# FTXB24AXVJU Dimensional Data

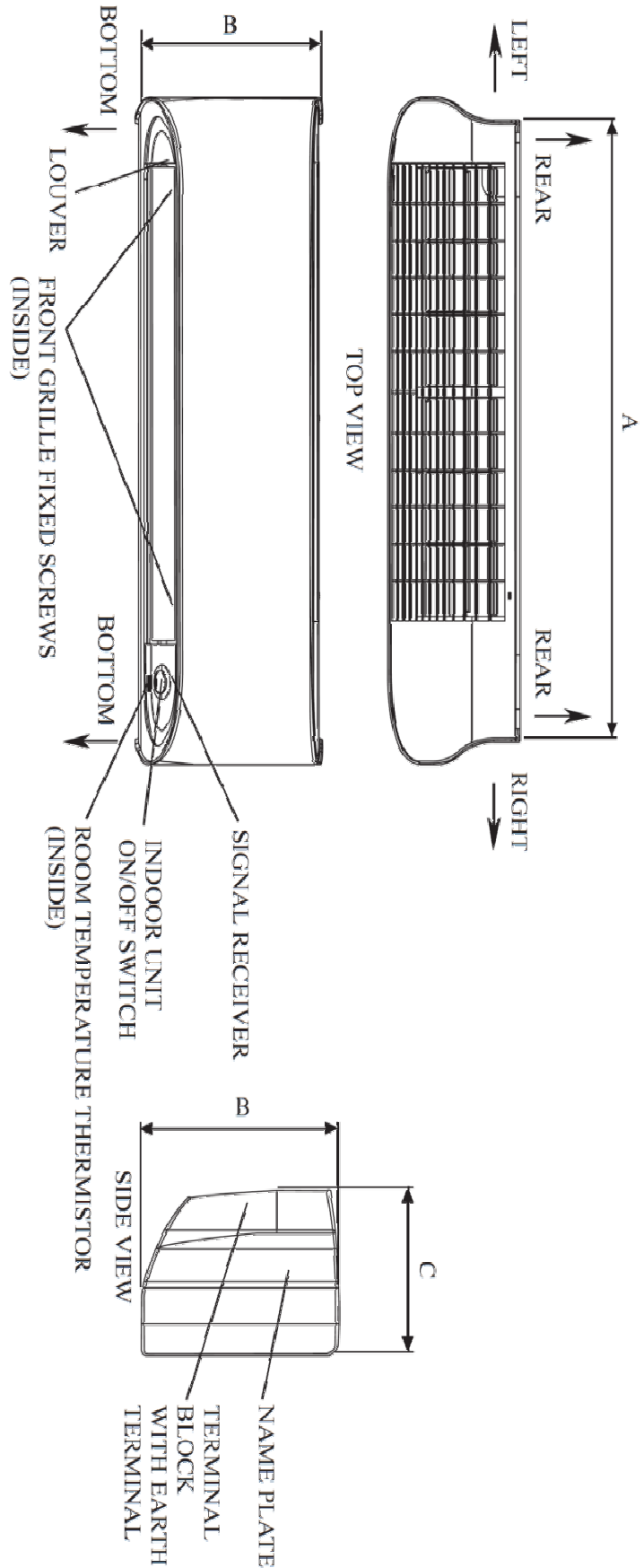

Model	Dimension		
18/24	A	B	C
	46-1/8 (1172)	12-5/8 (320)	9-1/2 (242)

Daikin North America LLC San Felipe, Suite 500 Houston, TX 77056

(Daikin's products are subject to continuous improvements. Daikin reserves the right to modify product design, specifications and information in this data sheet without notice and without incurring any obligations)

# RXB24AXVJU Dimensional Data

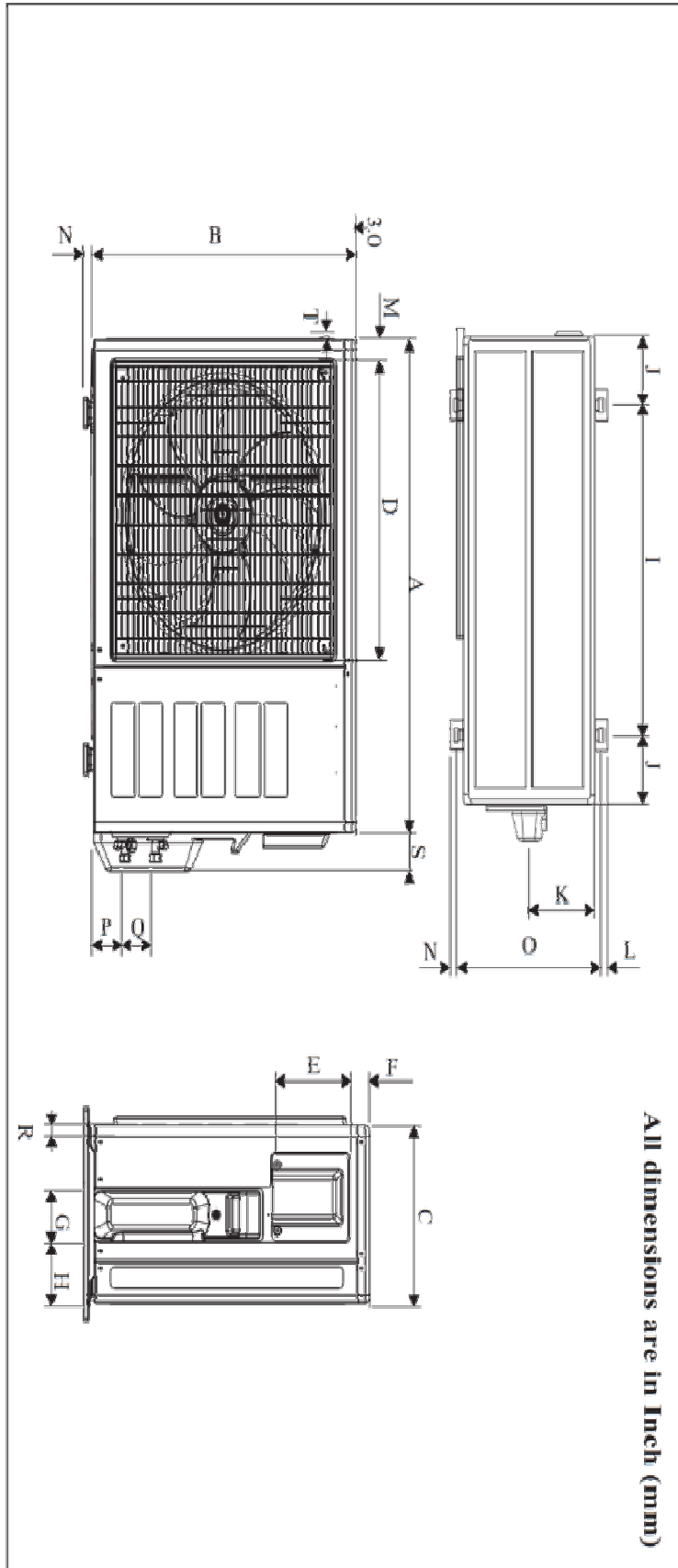

All dimensions are in Inch (mm)

Model	A	B	C	D	E	F	G	H	I	J	K	L	M	N	O
18	33-11/16 (855)	24-3/4 (628)	12-15/16 (328)	20-1/2 (520)	7-1/16 (179)	5-3/4 (46)	4 (101)	4-7/16 (113)	23-3/4 (603)	4-15/16 (126)	6-7/16 (164)	9/16 (15)	1-5/16 (34)	15/16 (23)	14-1/4 (362)
24	33-11/16 (855)	28-3/4 (730)	12-15/16 (328)	20-1/2 (520)	7-1/16 (179)	5-3/4 (46)	4 (101)	4-7/16 (113)	23-3/4 (603)	4-15/16 (126)	6-7/16 (164)	9/16 (15)	1-5/16 (34)	15/16 (23)	14-1/4 (362)
Dimension	P	Q	R	S	T										
18	2-7/8 (73)	2-15/16 (75)	5/16 (8)	2-5/8 (67)	1/4 (7)										
24	2-7/8 (73)	2-15/16 (75)	5/16 (8)	2-5/8 (67)	1/4 (7)										

