









barkman™

SPECS





Pavers	5
Bullnose	6
Flagstone	6
Holland	7
Roman	8
Roman Circle	9
Verano	11
Broadway 65mm	12
Fjord	14
Hexagon 65mm NEW	15
Boardwalk	16
Cobble	17
Holland 80mm	18
Mesa Flagstone	19
Navarro	20
Broadway 100mm	21
Broadway Planks 100mm	21
Broadway Contour 100mm NEW	21
Colonial Eco	24
Holland Eco	24
Turfstone Eco	24
Paver Material Requirements	25
Slabs	26
Arborwood	27
Bridgewood	28
Brookside	29
Diamond Face	30
Footing Pads	30
Lexington	31
Rosetta® Dimensional Flagstone 	32
Rosetta® Grand Flagstone 	33
Stepping Stones	33
Terrace NEW	34

Walls & Steps	35
Architectures	36
Architectures Atlas	36
Bridgewood Wall	37
Keystone Compac® III	37
MagnumStone™	38
Quarry Stone	39
RomanStack®	39
Rosetta® Belvedere 	40
Rosetta® Dimensional Wall 	41
Rosetta® Kodah 	41
Rosetta® Outcropping 	42
StackStone®	43
Retaining Wall Material Requirements	43
Bridgewood Steps	44
Rosetta® Dimensional Steps 	44
Rosetta® Irregular Steps 	44
Finishing Touches	45
Granite Edger	46
I-Con Edger	46
Adhesive	47
Edge Restraint	47
Installation Tools	48
Landscaping Materials	48
Polymeric Sand	48
Installation Recommendations	49
Colours	50
Base	52

Landscape Kits	53
Quarry Stone Fireplace	54
Quarry Stone Compact Fireplace	54
Architectures Fire Pit	55
Bridgewood Fire Pit	55
Quarry Stone Fire Pit	56
Smooth Quarry Stone Fire Pit	56
Rosetta® Belvedere Fire Pit	57
Rosetta® Dimensional Fire Pit	57
StackStone Fire Pit	58
StackStone Fire Pit Accessories NEW	58
Barkman Outdoor Kitchen Kits	59
Specialty Products	62
Barrier Curbs	62
Highway Barrier Curbs	62
Curbs	62
Boat Ramp Pads	62
Splash Pads	62
Pallet Return Guide	63
Returnable Pallet	63
Unreturnable Pallet	63
Important Information	64
The Environment	64
Barkman Warranty	64
Quality and Support Pledge	64
How to Order	64
Installation and Project Estimation Support	64
Colour Blend Information	64
Product Changes for 2023	64

 Rosetta® Signature Collection



POLYBIND COMPLETE G2

For joints up to 4" in traditional and 2" in overlay applications

Ideal for

- Residential and Commercial use
- Traditional, overlay and Gator Base applications
- Concrete pavers, natural stones, wet cast products and clay pavers
- Streetscapes, commercial work, steep slopes, pool areas, patios, walkways, driveways and parking areas

Features

- Traditional applications, **Rain safe 15 minutes** after water activation
- Overlay applications, **Rain safe 24 hours** after water activation

OXFORD GREY

NEVADA TAN

IVORY WHITE

JET
BLACK

barkman[™]

POLYBIND

BY ALLIANCE DESIGNER PRODUCTS

Polybind.com



Ground-up project planning, at your fingertips.

From calculating quantities to the most detailed specs,
our Barkman app takes the guesswork out of job planning.
Download and get started today!

barkman[™]

NEW PRODUCTS

Being at the cutting edge of design and technology means we are continually updating and expanding our product line. Please enjoy our new offerings for 2023:

Hexagon 65mm



Creative opportunities are made possible with our new Hexagon 65mm paver. This product matches well with our Broadway 65mm to make your own unique spaces.

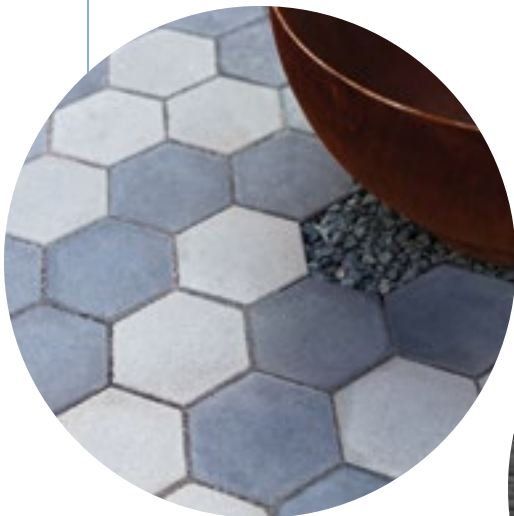

Broadway Contour 100mm

This product is our latest addition to the Broadway family which has the versatility of Broadway with a new, textured face.



StackStone Fire Pit Coping and Liner

Upgrade your fire pit and increase its longevity with our Coping and Liner for our StackStone fire pits.

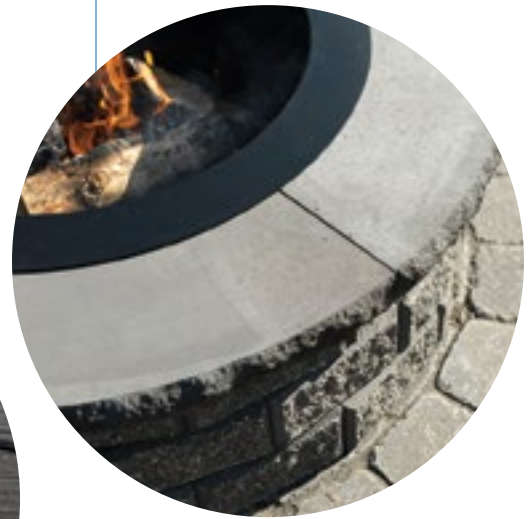



PAVERS

Whether it is a large or small project, Barkman pavers offer a wide selection of options for your patio, walkway, driveway or parking space. Far from just looks, our pavers offer quality assurance through testing and the use of superior grade materials throughout the manufacturing process. We believe we have a paver for any aspiring design.

Bullnose

DESCRIPTION	UNIT					PALLET					PRICE
	SIZE (L X W X H)		FACE AREA		WEIGHT	NO. OF UNITS	NO. OF HORIZONTAL LAYERS	TOTAL LENGTH		WEIGHT	
	MM	IN	M2	SQ FT	LB			M	LNFT	LB	
Roman (Tumbled)	305 x 152 x 60	12 x 6 x 2.36	0.04	0.5	13	144	9	21.95	72	1872	
Smooth	305 x 152 x 60	12 x 6 x 2.36	0.04	0.5	13	144	3	21.95	72	1872	

COLOURS	ITEM NO. SMOOTH	ITEM NO. ROMAN
Charcoal	202691	213727



Notes: Product available to order in full pallets only. A \$35.00 returnable pallet fee will be charged to any bundle of Smooth and Roman Bullnose pavers. Special order minimum quantity is 1000 sq ft. Contact your local Barkman sales representative for further details. When installing this product, make sure to include a 2-5mm gap between each unit. This will provide enough room for the jointing sand and make installation easier. The Unit of Measure for Bullnose is Each.

Flagstone

DESCRIPTION	UNIT					PALLET						PRICE
	SIZE (L X W X H)		FACE AREA		WEIGHT	NO. OF HORIZONTAL LAYERS	NO. OF UNITS	NO. OF ROWS	FACE AREA		WEIGHT	
	MM	IN	M2	SQ FT	LB				M2	SQ FT	LB	
Flagstone Paver	457.3 x 379.1/228 x 60	18 x 14.92/8.98 x 2.36	0.11	1.21	35	10	80	-	9.01	96.8	2800	

COLOURS	ITEM NO.
Sierra Grey	214580
Antique Brown	214579



Notes: Available to order in full pallets only. Recommended to use **Paver Saver Mat (103164)** between plate compactor and surface. Each pallet has six different patterned blocks. Recommended to use Polybind Complete G2 Polymeric Sand to accommodate the false joints. A \$35.00 returnable pallet fee will be charged to any bundle of Flagstone. Special order minimum quantity is 1000 sq ft. Contact your local Barkman sales representative for further details. When installing this product, make sure to include a 2-5mm gap between each unit. This will provide enough room for the jointing sand and make installation easier. The Unit of Measure for Flagstone is Each.

PATTERNS



Pieces per 100 sq. ft.
83 pieces Flagstone = 100% of total area

Holland

DESCRIPTION	UNIT					PALLET ROW				PALLET				PRICE
	SIZE (L X W X H)		FACE AREA		WEIGHT	NO. OF UNITS	FACE AREA		NO. OF UNITS	NO. OF ROWS	FACE AREA		WEIGHT	
	MM	IN	M2	SQ FT	LB		M2	SQ FT			M2	SQ FT	LB	
8 x 4	210 x 105 x 60	8.27 x 4.13 x 2.36	0.02	0.24	6.73	80	1.76	19.2	400	5	8.92	96	2691	
8 x 8	210 x 210 x 60	8.27 x 8.27 x 2.36	0.04	0.48	13.46	40	1.76	19.2	200	5	8.92	96	2691	

COLOURS	ITEM NO. 8X4	ITEM NO. 8X8
Natural	202720	-
Charcoal	202734	202801
Antique Brown	202740	-
Sierra Grey	202739	202805
Graphite (BC only)	143572	
Desert Buff (BC only)	202742	

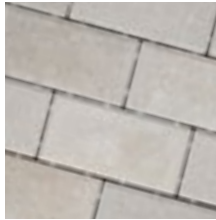

Specs: Holland has 10 horizontal layers per pallet and each layer is 9.6 sq. ft per layer.

Notes: Holland pavers can be installed in a running bond or herringbone pattern with border options that can be combined with other pavers. The patterns listed below can also be used on our 8CM Holland paver. To calculate soldier course, multiply lineal footage by 0.7; this will indicate the square footage of Holland required. To calculate sailor course, multiply lineal footage by 0.35, this will indicate the square footage of Holland required. A \$35.00 returnable pallet fee will be charged to any bundle of Holland. Contact your local Barkman sales representative for further details. Special order minimum quantity is 1000 sq ft per size. The Unit of Measure for Holland is Each.

PATTERNS

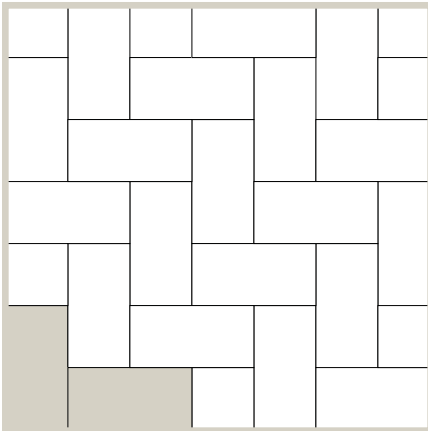

Herringbone
 Pieces per 100 sq. ft.
 417 pieces: 8 x 4 = 100% of total area

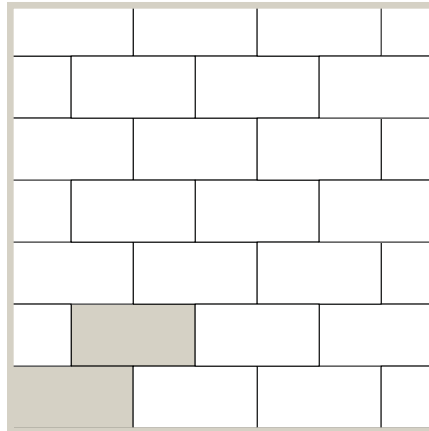

Running Bond 1
 Pieces per 100 sq. ft.
 417 pieces: 8 x 4 = 100% of total area

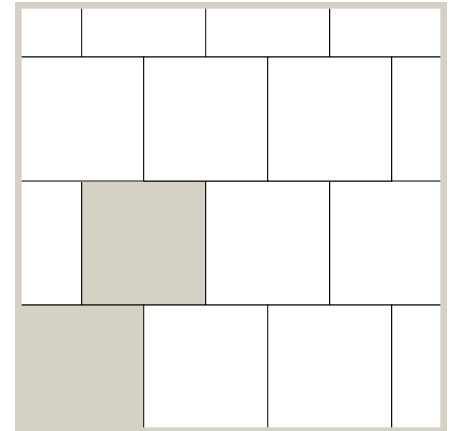

Running Bond 2
 Pieces per 100 sq. ft.
 209 pieces: 8 x 8 = 100% of total area

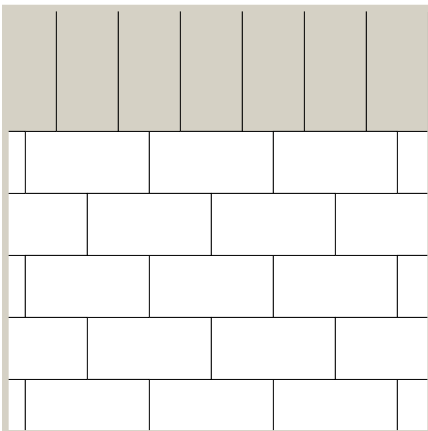

Soldier Course

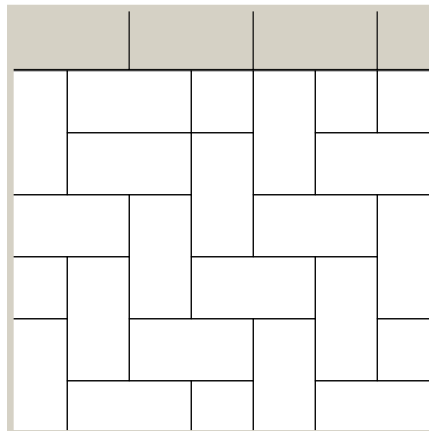

Sailor Course

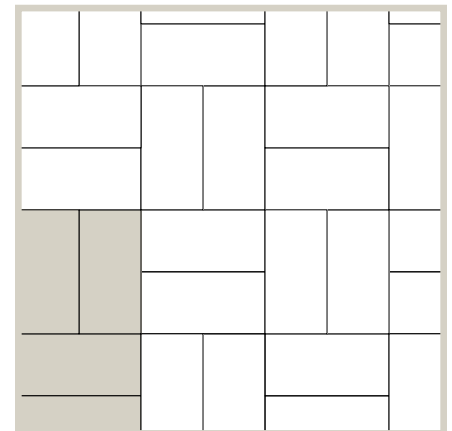

Parquet
 Pieces per 100 sq. ft.
 417 pieces: 8 x 4 = 100% of total area

Roman

DESCRIPTION	UNIT					PALLET ROW			PALLET				PRICE	
	SIZE (L X W X H)		FACE AREA		WEIGHT	NO. OF UNITS	FACE AREA		NO. OF UNITS	NO. OF ROWS	FACE AREA			WEIGHT
	MM	IN	M2	SQ FT	LB		M2	SQ FT			M2	SQ FT		LB
8x4	210 x 105 x 60	8.27 x 4.13 x 2.36	0.02	0.24	6.73	80	1.76	19.2	400	5	8.92	96	2691	
8x6	210 x 157.5 x 60	8.27 x 6.20 x 2.36	0.03	0.36	10.09	50	1.65	18.0	250	5	8.36	90	2523	
8x10	210 x 262.5 x 60	8.27 x 10.33 x 2.36	0.06	0.59	16.82	40	2.2	23.60	160	4	8.77	94.4	2691	
8x12	210 x 315 x 60	8.27 x 12.40 x 2.36	0.07	0.71	20.19	40	2.65	28.4	160	4	10.58	113.6	3230	

COLOURS	ITEM NO. 8X4	ITEM NO. 8X6	ITEM NO. 8X10	ITEM NO. 8X12
Charcoal	202978	202979	202976	202977
Desert Buff	203055	203056	202995	202996
Antique Brown	202984	202985	202982	202981
Sierra Grey	202992	202993	202980	202991
Graphite (BC only)	143582	143584	143586	143588
Natural (BC Only)	143581	143583	143585	143587



Specs:

- Roman 8x4 - 10 horizontal layers per pallet with 9.6 sq. ft per layer
- Roman 8x6 - 10 horizontal layers per pallet with 9 sq. ft. per layer
- Roman 8x10 - 10 horizontal layers per pallet with 9.44 sq. ft. per layer
- Roman 8x12 - 10 horizontal layers per pallet with 11.36 sq. ft. per layer

Notes: Roman pavers are rectangular and come in four sizes on separate pallets. They can be installed using one size only in a running bond or herringbone pattern, or they can be installed by mixing the sizes to create a random pattern. A \$35.00 returnable pallet fee will be charged to any bundle of Roman. Contact your local Barkman sales representative for further details. Special order minimum quantity is 1000 sq ft per size. When installing this product, make sure to include a 2-5mm gap between each unit. This will provide enough room for the jointing sand and make installation easier. The Unit of Measure for Roman is Each.

PATTERNS

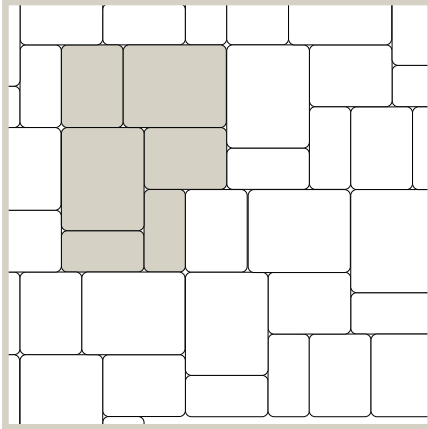

Pattern 1
 Pieces per 100 sq. ft.
 85 pieces: 8 x 10 = 50% of total area
 85 pieces: 8 x 6 = 30% of total area
 85 pieces: 8 x 4 = 20% of total area

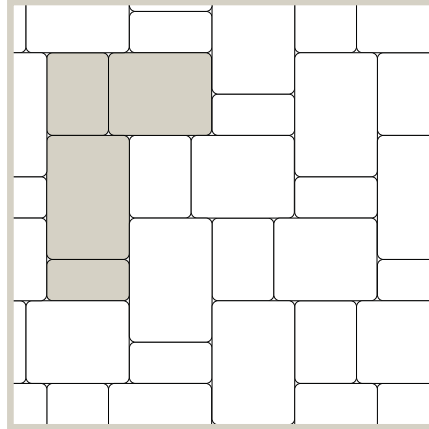

Pattern 2
 Pieces per 100 sq. ft.
 53 pieces: 8 x 12 = 38% of total area
 53 pieces: 8 x 10 = 31% of total area
 53 pieces: 8 x 6 = 19% of total area
 53 pieces: 8 x 4 = 12% of total area

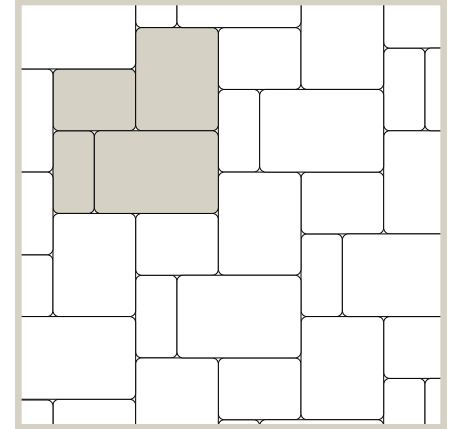

Pattern 3
 Pieces per 100 sq. ft.
 53 pieces: 8 x 12 = 38% of total area
 53 pieces: 8 x 10 = 31% of total area
 53 pieces: 8 x 6 = 19% of total area
 53 pieces: 8 x 4 = 12% of total area

Roman Circle

DESCRIPTION	UNIT				PALLET						PRICE
	SIZE (OUTSIDE DIAMETER X H)		FACE AREA		HORIZ. LAYERS	NO. OF UNITS	NO. OF ROWS	FACE AREA		WEIGHT	
	MM	IN	M2	SQ FT				M2	SQ FT	LB	
Roman Circle Bundle	3148 x 60	123.96 x 2.36	-	-	9	1	-	8.27	89.1	2607	

COLOURS	ITEM NO.
Charcoal	203124
Antique Brown	203126
Sierra Grey	203125
Graphite (BC only)	143592
Natural (BC Only)	143591

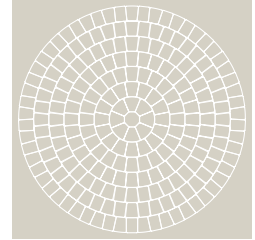

Specs: Roman Circle has 9 horizontal layers per pallet and each layer is 9.9 sq. ft. per layer

Notes: Available to order in full pallets only. Due to bundle configuration, customer will receive nine starter stones. Customer is not charged for extra starter stones. To expand Roman Circle past the 10.33 ft. diameter, please refer to chart below for quantities using 8x6 Roman pavers. Additional 8x6 courses will have larger gaps between stones. A \$35.00 returnable pallet fee will be charged to any bundle of Roman Circle. Special order minimum quantity is 1000 sq ft. Contact your local Barkman sales representative for further details. When installing this product, make sure to include a 2-5mm gap between each unit. This will provide enough room for the jointing sand and make installation easier. The Unit of Measure for Roman Circle is Pallet.

COURSE NO.	SIZE		PIECES PER COURSE	TOTAL PIECES REQUIRED
	DIAMETER			
	M	FT		
8	3.57	11.71	67	67
9	3.99	13.08	75	142
10	4.41	14.46	84	226
11	4.82	15.83	92	318
12	5.25	17.21	101	419
13	5.66	18.58	109	528
14	6.08	19.96	117	645
15	7.42	21.33	126	771
16	6.92	22.71	134	905
17	7.34	24.08	142	1047
18	7.76	25.46	151	1198
19	8.18	26.83	159	1357
20	8.60	28.21	168	1525
21	9.02	29.58	176	1701
22	9.44	30.96	184	1885
23	9.85	32.33	193	2078
24	10.27	33.71	201	2279



PAVERS 60MM

COURSE NO.	8.25" X 8.25"	8.25" X 9"	8.25" X 7.75"	8.25" X 7"	8.25" X 6.1875"
Center	1	0	0	0	0
1	0	8	0	0	0
2	0	0	16	0	0
3	0	0	0	24	0
4	0	0	0	32	0
5	0	0	0	20	20
6	0	0	0	24	24
7	0	0	0	29	29
TOTAL	9	9	18	135	81
EXTRA	8	1	2	6	8

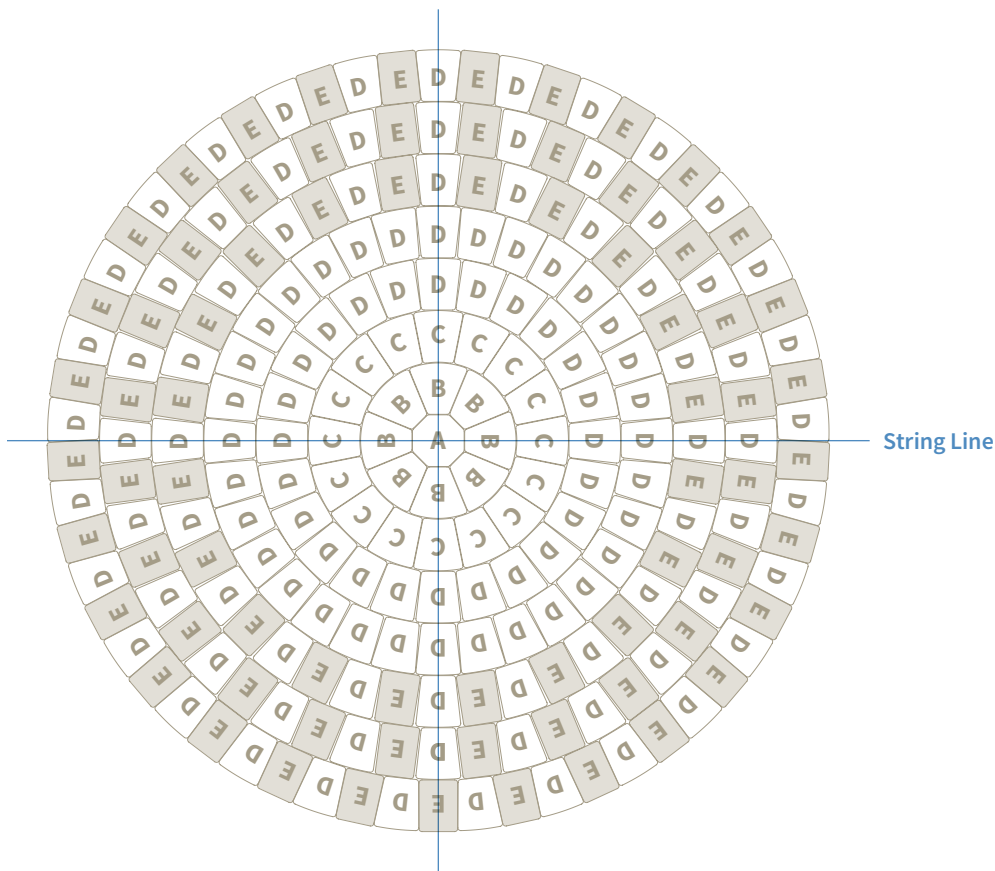

Notes: One circle bundle covers 83.86 sq ft, 10 1/3 ft in diameter. Space between rows is 2mm. Space between pavers vary from 2mm-5mm

Verano

DESCRIPTION	UNIT					PALLET						PRICE
	SIZE (L X W X H)		FACE AREA		WEIGHT	NO. OF HORIZONTAL LAYERS	NO. OF UNITS	NO. OF ROWS	FACE AREA		WEIGHT	
	MM	IN	M2	SQ FT	LB				M2	SQ FT	LB	
6x6	146.1 x 146.1 x 60	5.75 x 5.75 x 2.36	0.02	0.23	6	10	60	-	8.92	96	2784	
12x6	292.1 x 146.1 x 60	11.5 x 5.75 x 2.36	0.04	0.46	13		60	-				
12x12	292.1 x 292.1 x 60	11.5 x 11.5 x 2.36	0.09	0.92	25		60	-				

COLOURS	ITEM NO.	ITEM NO. NON CHAMFER
Sierra Grey	203170	Special order
Charcoal	223156	Special order



Notes: Each bundle contains 96 sq. ft. with all three sizes combined. Available to order in full pallets only. Verano is a non-tumbled paver with smooth face. A \$35.00 returnable pallet fee will be charged to any bundle of Verano. Special order minimum quantity is 1000 sq ft. Contact your local Barkman sales representative for further details. The non-chamfer Verano paver is a special order option that is ideal for American/Canadian Disability Act (ADA/CDA) compliance. For more information, ask your local sales representative. The Unit of Measure for Verano is Layer.

PATTERNS

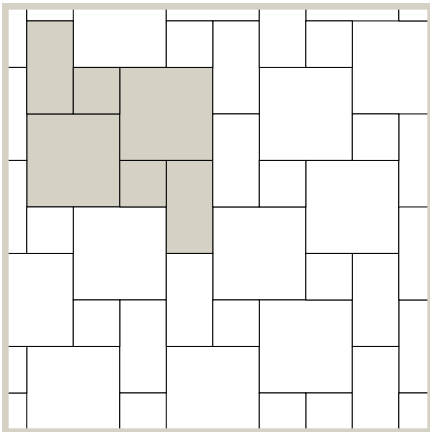

Pattern 1

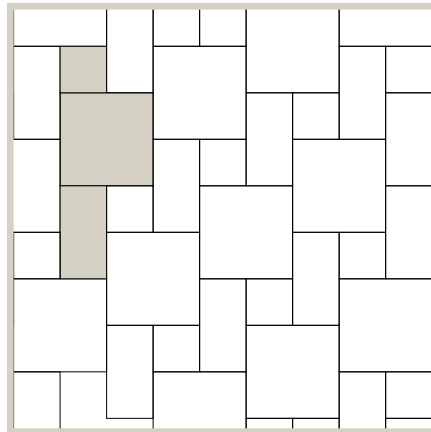

Pattern 2



Broadway 65mm

DESCRIPTION	UNIT					PALLET					PRICE
	SIZE (L X W X H)		FACE AREA		WEIGHT	NO. OF HORIZONTAL LAYERS	NO. OF UNITS	FACE AREA		WEIGHT	
	MM	IN	M2	SQ FT	LB			M2	SQ FT	LB	
300 x 150 x 65	300 x 150 x 65	11.81 x 5.91 x 2.56	0.04	0.48	14.88	10	240	10.8	115.2	3570	
300 x 300 x 65*	300 x 300 x 65	11.81 x 11.81 x 2.56	0.09	0.97	29.75	10	90	8.10	87.3	2678	
600 x 300 x 65	600 x 300 x 65	23.62 x 11.81 x 2.56	0.18	1.94	59.50	10	60	10.80	116.4	3570	
600 x 600 x 65	600 x 600 x 65	23.62 x 23.62 x 2.56	0.36	3.87	119	10	20	7.20	77.4	2380	

COLOURS FACE MIX	ITEM NO. 300 X 150	ITEM NO. 300 X 300	ITEM NO. 600 X 300	ITEM NO. 600 X 600
Natural	234990	234989	234988	234987
Ash	241040	241041	241042	242636
Charcoal	234994	234993	234992	234991
Sterling	234998	234997	234996	234995
Sandstone	241043	241044	241045	241046
Amber	239853	239852	239851	239850
Quartz	236645	236644	236642	236643
Sierra Grey (BC only)	143649	143650	143651	143652
Graphite (BC only)	143653	143654	143655	143656



Notes: For over 50 Broadway design patterns, please visit our website. Available to order in full pallets only. A \$35.00 returnable pallet fee will be charged to any bundle. Special order minimum quantity is 1000 sq ft per size. Broadway 300 x 300 x 65mm can be used as Stepping Stones. The Unit of Measure for Broadway 65mm is Each.

PATTERNS

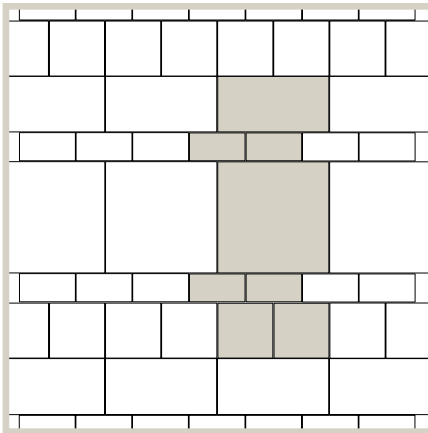

Pattern 1
 Pieces per 100 sqft
 (4) 300 x 150 = 20%, 42 pcs
 (2) 300 x 300 = 20%, 21 pcs
 (1) 600 x 300 = 20%, 10 pcs
 (1) 600 x 600 = 40%, 10 pcs

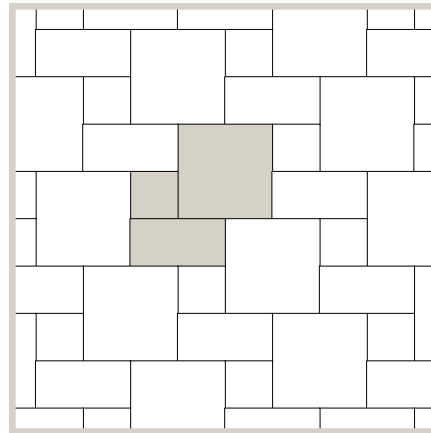

Pattern 2
 Pieces per 100 sqft
 (1) 300 x 300 = 14%, 15 pcs
 (1) 600 x 300 = 29%, 15 pcs
 (1) 600 x 600 = 57%, 15 pcs

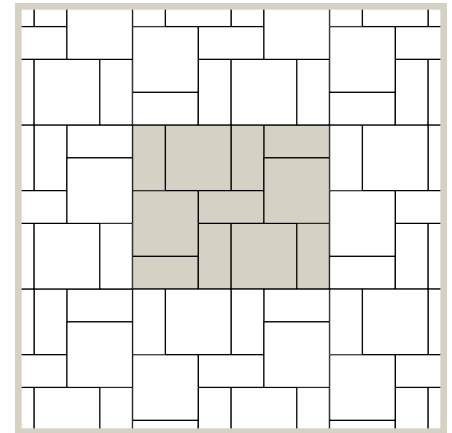

Pattern 3A
 Pieces per 100 Sqft
 300 x 300 = 54%, 56 pcs
 300 x 150 = 46%, 126 pcs

Broadway 65mm

PATTERNS

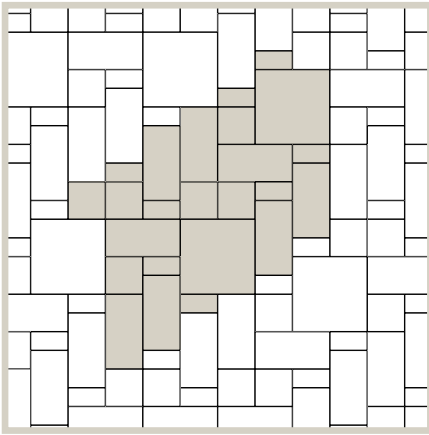

Pattern 4

Pieces per 100 sqft
 (8) 300 x 150 = 12%, 24 pcs
 (6) 300 x 300 = 18%, 18 pcs
 (8) 600 x 300 = 47%, 24 pcs
 (2) 600 x 600 = 23%, 6 pcs

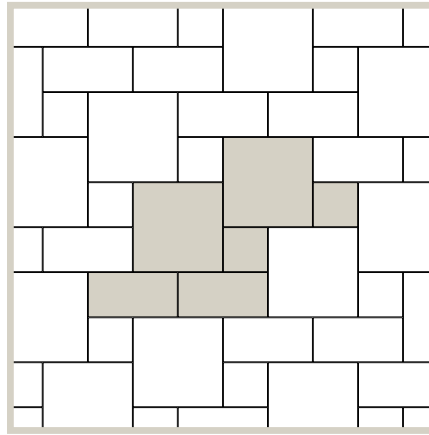

Pattern 5

Pieces per 100 sqft
 (1) 300 x 300 = 14%, 15 pcs
 (1) 600 x 300 = 29%, 15 pcs
 (1) 600 x 600 = 57%, 15 pcs

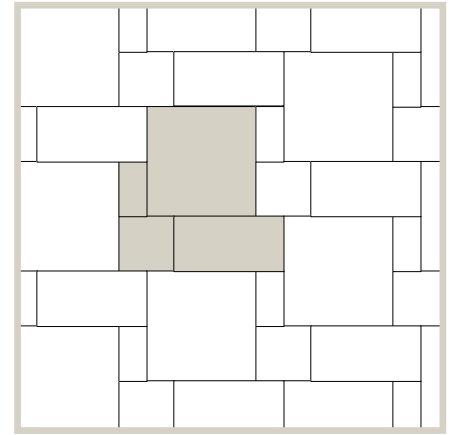

Pattern 6

Pieces per 100 sqft
 (1) 300 x 150 = 7%, 14 pcs
 (1) 300 x 300 = 13%, 14 pcs
 (1) 600 x 300 = 27%, 14 pcs
 (1) 600 x 600 = 53%, 14 pcs

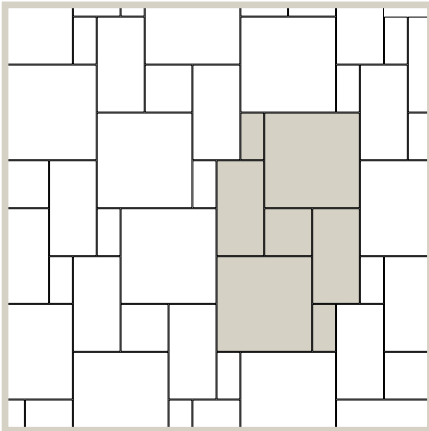

Pattern 7

Pieces per 100 sqft
 (2) 300 x 150 = 7%, 15 pcs
 (1) 300 x 300 = 7%, 7 pcs
 (2) 600 x 300 = 29%, 15 pcs
 (2) 600 x 600 = 57%, 15 pcs

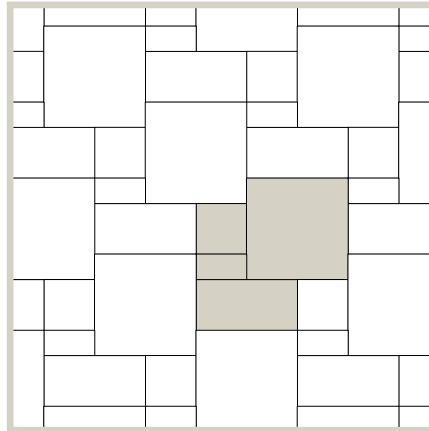

Pattern 8

Pieces per 100 sqft
 (1) 300 x 150 = 7%, 14 pcs
 (1) 300 x 300 = 13%, 14 pcs
 (1) 600 x 300 = 27%, 14 pcs
 (1) 600 x 600 = 53%, 14 pcs

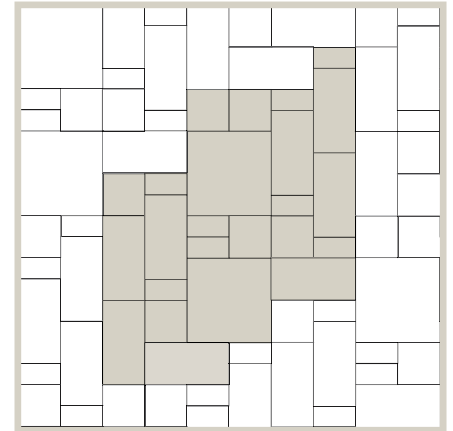

Pattern 9

Pieces per 100 sqft
 (2) 600 x 600 = 23.5%, 6 pcs
 (8) 600 x 300 = 47%, 24 pcs
 (6) 300 x 300 = 17.5%, 18 pcs
 (8) 300 x 150 = 12%, 24 pcs

Fjord

DESCRIPTION	UNIT					PALLET					PRICE
	SIZE (L X W X H)		FACE AREA		WEIGHT	NO. OF HORIZONTAL LAYERS	NO. OF UNITS	FACE AREA		WEIGHT	
	MM	IN	M2	SQ FT	LB			M2	SQ FT	LB	
300 x 300	300 x 300 x 65	11.81 x 11.81 x 2.56	0.09	0.97	29.75	10	60	5.4	58.2	1785	
600 x 300	600 x 300 x 65	23.62 x 11.81 x 2.56	0.18	1.94	59.50	10	30	5.4	58.2	1785	
600 x 600	600 x 600 x 65	23.62 x 23.62 x 2.56	0.36	3.87	119	10	20	7.2	77.4	2380	

COLOURS FACE MIX	ITEM NO. 300 X 300	ITEM NO. 600 X 300	ITEM NO. 600 X 600
Glacier	242344	242346	242350
Bedrock	242345	242347	242351



Notes: Available to order in full pallets only. A \$35.00 returnable pallet fee will be charged to any bundle. The Unit of Measure for Fjord is Each.

PATTERNS

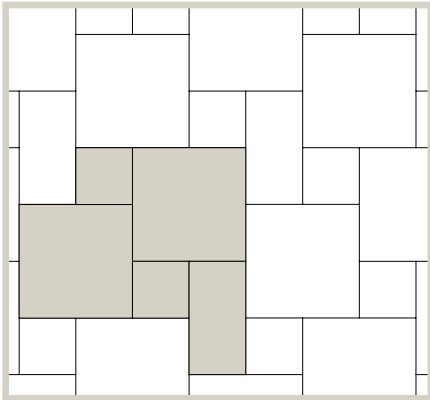

Pattern 1

Pieces per 100 sqft

(2) 300 x 300 = 26.67%, 18 pcs

(1) 300 x 600 = 20%, 9 pcs

(2) 600 x 600 = 53.33%, 18 pcs

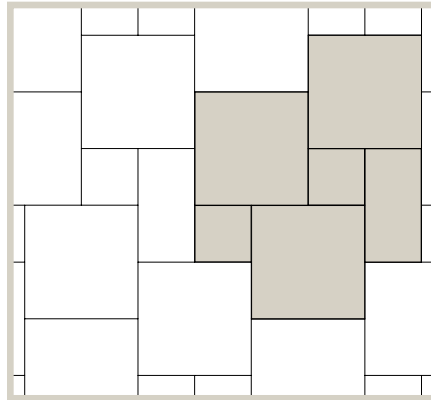

Pattern 2

Pieces per 100 sqft

(2) 300 x 300 = 21.05%, 13 pcs

(1) 300 x 600 = 15.79%, 7 pcs

(3) 600 x 600 = 63.16%, 20 pcs

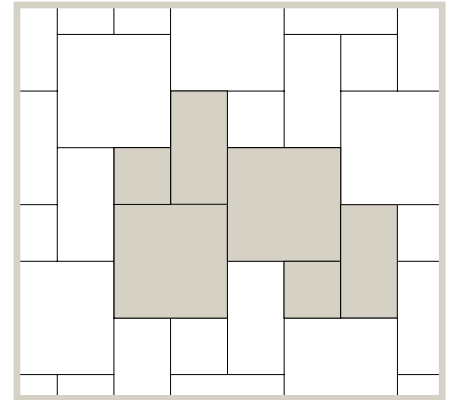

Pattern 3

Pieces per 100 sqft

(2) 300 x 300 = 22.22%, 15 pcs

(2) 300 x 600 = 33.33%, 15 pcs

(2) 600 x 600 = 44.44%, 15 pcs

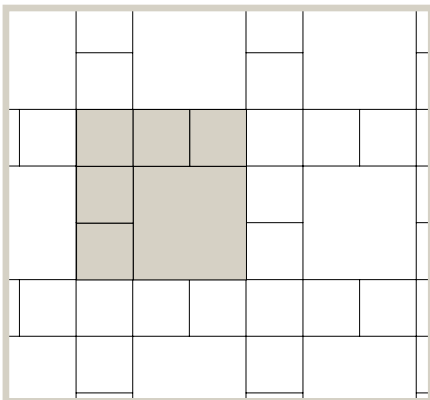

Pattern 4

Pieces per 100 sqft

(1) 300 x 300 = 71.43%, 58 pcs

(5) 600 x 600 = 28.57%, 12 pcs

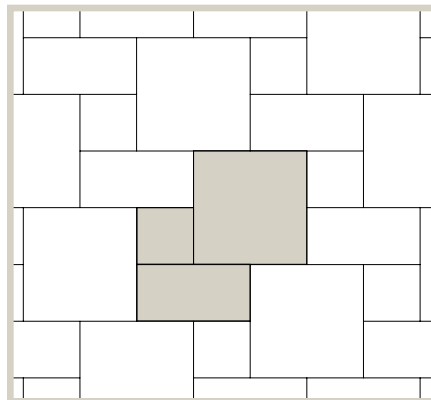

Pattern 5

Pieces per 100 sqft

(1) 300 x 300 = 22.22%, 15 pcs

(1) 300 x 600 = 33.33%, 15 pcs

(1) 600 x 600 = 44.44%, 15 pcs

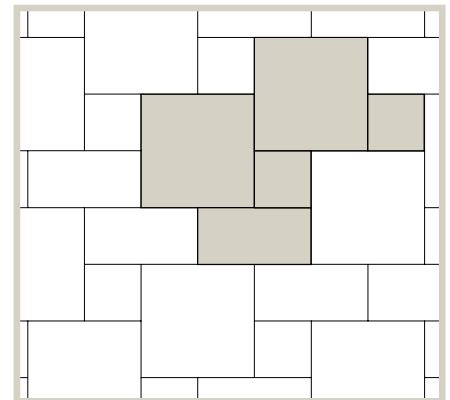

Pattern 6

Pieces per 100 sqft

(2) 300 x 300 = 22.22%, 15 pcs

(2) 300 x 600 = 33.33%, 15 pcs

(2) 600 x 600 = 44.44%, 15 pcs

Hexagon 65mm NEW

DESCRIPTION	UNIT					PALLET ROW			PALLET				PRICE	
	SIZE (L X W X H)		FACE AREA		WEIGHT	NO. OF UNITS	FACE AREA		NO. OF UNITS	NO. OF ROWS	FACE AREA			WEIGHT
	MM	IN	M2	SQ FT	LB		M2	SQ FT			M2	SQ FT		LB
225 x 195 x 65	225 x 195 x 65	8.86 x 7.68 x 2.56	0.033	0.35	11.00	18	0.58	6.28	180	10	5.83	62.77	2028	

COLOURS	ITEM NO.
Ash	143571
Charcoal	143570
Natural	143569

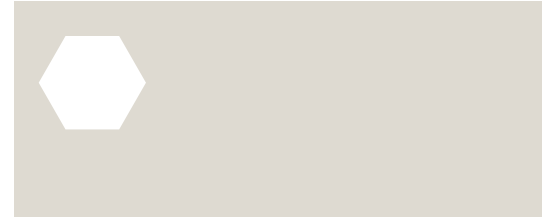

Notes: Hexagon 65mm uses the same spaces and chamfer as Broadway 65mm so it works well with each other. It's available to order in full pallets only. A \$35 returnable pallet fee will be charged to any bundle. The unit of measure for Hexagon 65mm is each.

PATTERNS

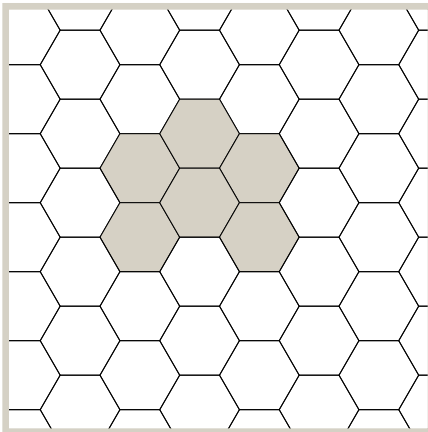

Pattern 1
287 pieces per 100 sq. ft.



Boardwalk

DESCRIPTION	UNIT					PALLET						PRICE
	SIZE (L X W X H)		FACE AREA		WEIGHT	NO. OF HORIZONTAL LAYERS	NO. OF UNITS	NO. OF ROWS	FACE AREA		WEIGHT	
	MM	IN	M2	SQ FT	LB				M2	SQ FT	LB	
14 x 4.5	362 x 119 x 80	14.25 x 4.69 x 3.15	0.04	0.44	17.17	7	28	-	7.06	75.74	2719	
14 x 3	362 x 89 x 80	14.25 x 3.50 x 3.15	0.03	0.32	13.15		28	-				
12.5 x 4.5	322 x 119 x 80	12.68 x 4.69 x 3.15	0.04	0.39	15.69		28	-				
12.5 x 3	322 x 89 x 80	12.68 x 3.50 x 3.15	0.03	0.29	11.70		28	-				
11 x 4.5	282 x 119 x 80	11.10 x 4.69 x 3.15	0.03	0.34	13.76		28	-				
11 x 3	282 x 89 x 80	11.10 x 3.50 x 3.15	0.02	0.25	10.26		28	-				
9 x 4.5	242 x 119 x 80	9.53 x 4.69 x 3.15	0.03	0.29	11.82		28	-				
9 x 3	242 x 89 x 80	9.53 x 3.50 x 3.15	0.02	0.21	8.82		28	-				

COLOURS	ITEM NO.
Special Order	-

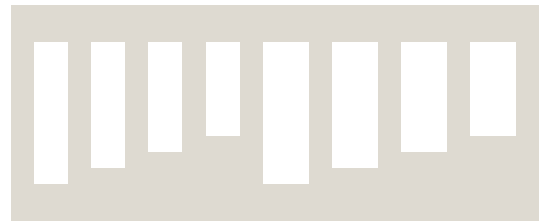

Notes: Each bundle contains 76 sq. ft. between the eight sizes. Recommended to use **Paver Saver Mat (103164)** between the plate compactor and surface. Boardwalk is compatible with some machine paver laying systems. Boardwalk can also be installed as a permeable paver. Available to order in full pallets only. Recommended to use Polybind Complete G2 Polymeric Sand for commercial applications if not using for permeable. A \$35.00 returnable pallet fee will be charged to any bundle of Boardwalk. Special order minimum quantity is 1000 sq ft. Contact your local Barkman sales representative for further details. Product designed to be installed in a running bond pattern. The Unit of Measure for Boardwalk is Layer.

PATTERNS

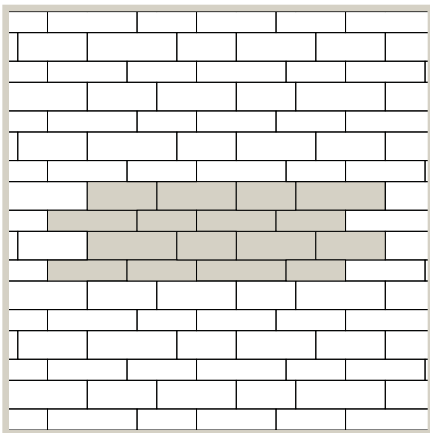

Cobble

DESCRIPTION	UNIT					PALLET						PRICE
	SIZE (L X W X H)		FACE AREA		WEIGHT	NO. OF HORIZONTAL LAYERS	NO. OF UNITS	NO. OF ROWS	FACE AREA		WEIGHT	
	MM	IN	M2	SQ FT	LB				M2	SQ FT	LB	
7x6	180 x 150 x 80	7.09 x 5.91 x 3.15	0.03	0.29	-	7	56	-	7.99	86.8	2870	
9x6	220 x 150 x 80	8.66 x 5.91 x 3.15	0.03	0.35	-		56	-				
10x6	260 x 150 x 80	10.24 x 5.91 x 3.15	0.04	0.40	-		56	-				
12x6	300 x 150 x 80	11.81 x 5.91 x 3.15	0.04	0.45	-		56	-				

COLOURS	ITEM NO.
Charcoal	242306

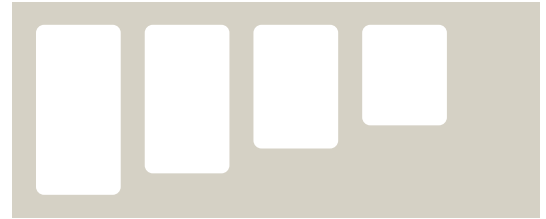
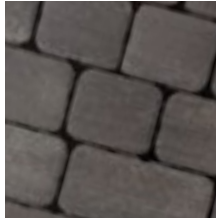

Notes: Each pallet contains seven layers with four different sizes. Recommended to use **Paver Saver Mat (103164)** between plate compactor and surface. This product is laid completely random within a running bond pattern. Recommended to use Polybind Complete G2 Polymeric Sand for commercial applications that are not permeable. Available to order in full pallets only. A \$35.00 returnable pallet fee will be charged to any bundle of Cobble. Special order minimum quantity is 1000 sq ft. Contact your local Barkman sales representative for further details. The Unit of Measure for Cobble is Layer.

PATTERNS

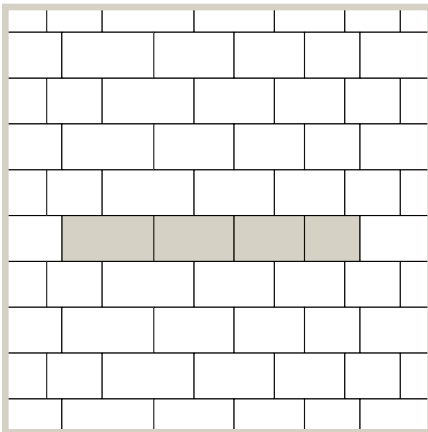

Running Bond 1



Holland 80mm

DESCRIPTION	UNIT					PALLET ROW			PALLET				PRICE	
	SIZE (L X W X H)		FACE AREA		WEIGHT	NO. OF UNITS	FACE AREA		NO. OF UNITS	NO. OF ROWS	FACE AREA			WEIGHT
	MM	IN	M2	SQ FT	LB		M2	SQ FT			M2	SQ FT		LB
Holland 80mm	210 x 105 x 80	8.27 x 4.13 x 3.15	0.02	0.24	9.3	64	1.41	15.36	320	5	7.15	76.8	2976	

COLOURS	ITEM NO.
Charcoal	202752



Specs: Holland has 8 horizontal layers per pallet and each layer is 9.6 sq. ft. per layer

Notes: Recommended to use Polybind Complete G2 Polymeric Sand for commercial applications. See Holland on page 7 for patterns. A \$35.00 returnable pallet fee will be charged to any bundle of Holland 8CM. Special order minimum quantity is 1000 sq ft. Contact your local Barkman sales representative for further details. The Unit of Measure for Holland 80mm is Each.

PATTERNS

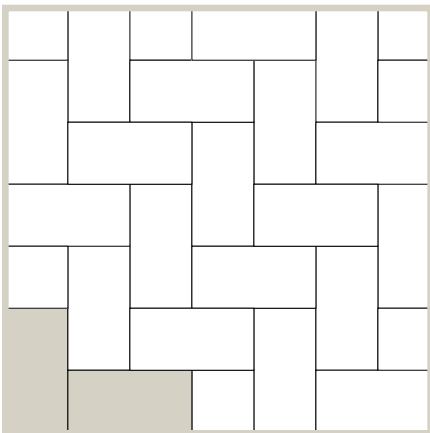

Herringbone
 Pieces per 100 sq. ft.
 417 pieces: 8 x 4 = 100% of total area

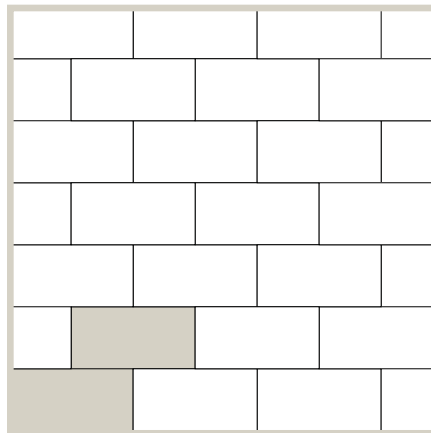

Running Bond 1
 Pieces per 100 sq. ft.
 417 pieces: 8 x 4 = 100% of total area

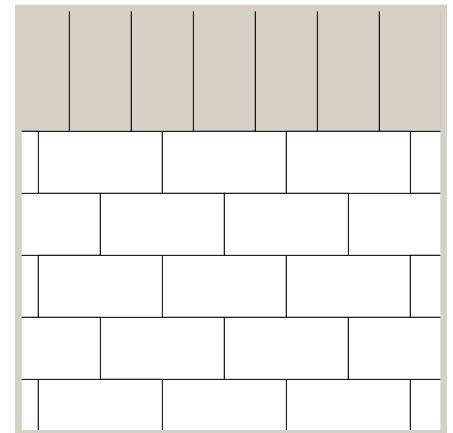

Soldier Course

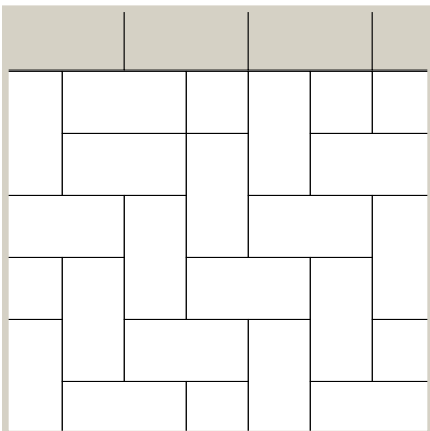

Sailor Course

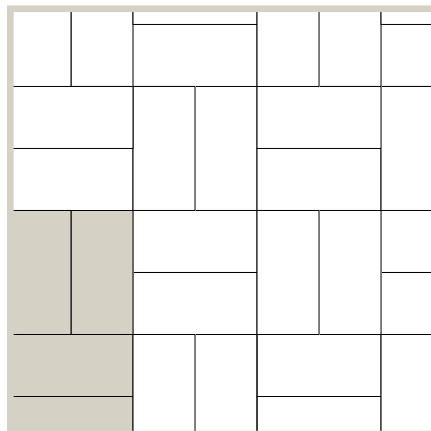

Parquet
 Pieces per 100 sq. ft.
 417 pieces: 8 x 4 = 100% of total area

Mesa Flagstone

DESCRIPTION	UNIT					PALLET						PRICE
	SIZE (L X W X H)		FACE AREA		WEIGHT	NO. OF HORIZONTAL LAYERS	NO. OF UNITS	NO. OF ROWS	FACE AREA		WEIGHT	
	MM	IN	M2	SQ FT	LB				M2	SQ FT	LB	
Mesa Flagstone	613.3 x 330.8 x 80	24.14 x 13.02 x 3.15	0.15	1.62	58	8	48	-	7.2	77.76	2784	

COLOURS	ITEM NO.
Sierra Grey	241646
Sterling	241648



Notes: Available to order in full pallets only. Recommended to use **Paver Saver Mat (103164)** between plate compactor and paver surface. Recommended to use Alliance Polybind Complete G2 sand to accommodate the false joints. A \$35.00 returnable pallet fee will be charged to any bundle of Mesa Flagstone. Special order minimum quantity is 1000 sq ft. Contact your local Barkman sales representative for further details. The Unit of Measure for Mesa Flagstone is Each.

PATTERNS

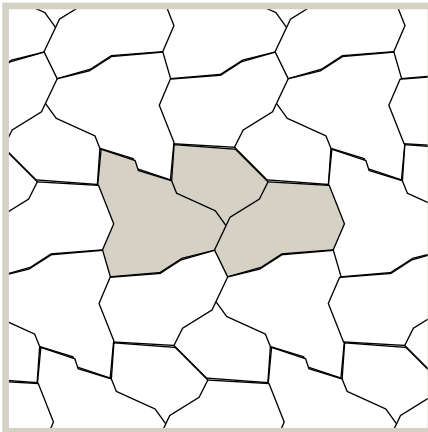

Pieces per 100 sqft
62 pieces Mesa Flagstone = 100% of total area,

Navarro

DESCRIPTION	UNIT					PALLET						PRICE
	SIZE (L X W X H)		FACE AREA		WEIGHT	NO. OF HORIZONTAL LAYERS	NO. OF UNITS	NO. OF ROWS	FACE AREA		WEIGHT	
	MM	IN	M2	SQ FT	LB				M2	SQ FT	LB	
12 x 6	306 x 153 x 80	12.05 x 6.02 x 3.15	0.05	0.5	19	7	35	-	7.80	84	3100	
12 x 12	306 x 306 x 80	12.05 x 12.05 x 3.15	0.09	1	38		35	-				
12 x 18	306 x 459 x 80	12.05 x 18.07 x 3.15	0.14	1.50	57		21	-				

COLOURS	ITEM NO.
Sierra Grey	202719
Charcoal	242303

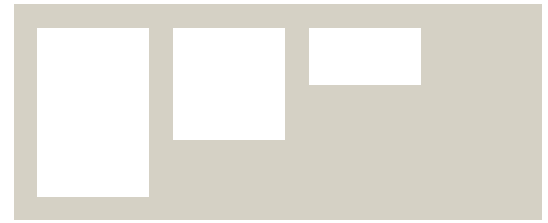

Notes: Available to order in full pallets only. Each bundle contains 84 sq. ft. between the three sizes. Recommended to use **Paver Saver Mat (103164)** between plate compactor and surface. Recommended to use Polybind Complete G2 Polymeric Sand for commercial applications. A \$35.00 returnable pallet fee will be charged to any bundle of Navarro. Special order minimum quantity is 1000 sq ft. Contact your local Barkman sales representative for further details. The Unit of Measure for Navarro is Layer.

PATTERNS

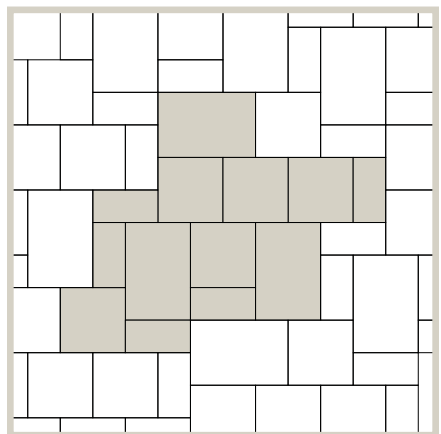

Pattern 3

Broadway, Planks and Contour 100mm

DESCRIPTION	UNIT					PALLET						PRICE
	SIZE (L X W X H)		FACE AREA		WEIGHT	NO. OF HORIZONTAL LAYERS	NO. OF UNITS	NO. OF ROWS	FACE AREA		WEIGHT	
	MM	IN	M2	SQ FT	LB				M2	SQ FT	LB	
BROADWAY 100MM												
300 x 150 x 100	300 x 150 x 100	11.81 x 5.91 x 3.94	0.04	0.48	22.88	6	144	-	6.42	69.12	3295	
300 x 300 x 100	300 x 300 x 100	11.81 x 11.81 x 3.94	0.09	0.97	45.76	6	72	-	6.48	69.84	3295	
600 x 300 x 100	600 x 300 x 100	23.62 x 11.81 x 3.94	0.18	1.94	91.53	6	36	-	6.48	69.84	3295	
900 x 450 x 100*	900 x 450 x 100	35.43 x 17.72 x 3.94	0.4	4.36	205.94	6	12	-	4.86	52.32	2471	
900 x 900 x 100*	900 x 900 x 100	35.43 x 35.43 x 3.94	0.81	8.72	411.87	6	6	-	4.86	52.32	2471	
BROADWAY PLANKS 100MM												
451 x 76 x 100	451 x 76 x 100	17.76 x 2.99 x 3.94	0.03	0.37	17.43	6	132	-	4.53	48.84	2301	
400 x 100 x 100	400 x 100 x 100	15.75 x 3.94 x 3.94	0.04	0.43	20.34	6	144	-	5.75	61.92	2929	
600 x 150 x 100	600 x 150 x 100	23.62 x 5.91 x 3.94	0.09	0.97	45.76	6	72	-	6.48	69.84	3295	
BROADWAY CONTOUR 100MM NEW												
451 x 76 x 100	451 x 76 x 100	17.76 x 2.99 x 3.94	0.03	0.37	17.43	6	132	-	4.53	48.84	2301	
400 x 100 x 100	400 x 100 x 100	15.75 x 3.94 x 3.94	0.04	0.43	20.34	6	144	-	5.75	61.92	2929	
600 x 150 x 100	600 x 150 x 100	23.62 x 5.91 x 3.94	0.09	0.97	45.76	6	72	-	6.48	69.84	3295	
600 x 300 x 100	600 x 300 x 100	23.62 x 11.81 x 3.94	0.18	1.94	91.53	6	36	-	6.48	69.84	3295	

COLOURS	ITEM NO. 300X150	ITEM NO 300X300	ITEM NO 600X300	ITEM NO 900X450*	ITEM NO 900X900*	ITEM NO. 451X76	ITEM NO 100X400	ITEM NO 150X600
FACE MIX								
Natural				235319	235320			
Ash				241475	241476			
Charcoal				235313	235314			
Sterling	241810	235323	235324	235325	235326	235321	239914	239915
Amber	241814	239856	239857	239858	239859	239854	239920	239921
Quartz	241812	236658	236659	236660	236661	236656	239916	239917
THRU MIX								
Natural	241798	202852	202853			214576	239924	239925
Ash	241806	223059	223060			214573	241477	241478
Charcoal	241797	213183	212503			214570	239922	239923
BROADWAY CONTOUR - SPECIAL ORDER								
Natural			143558-SO			143561-SO	143552-SO	143555-SO
Ash			143560-SO			143563-SO	143554-SO	143557-SO
Charcoal			143559-SO			143562-SO	143553-SO	143556-SO
Sterling			143724-SO			143725-SO	143722-SO	143723-SO

Notes: For over 50 Broadway Paver Patterns please visit our website. Available to order in full pallets only. Recommended to use Polybind Complete G2 Polymeric Sand for commercial application. A \$35.00 returnable pallet fee will be charged to any bundle of Broadway. Special order minimum quantity is 1000 sq ft per size. *900 x 450 x 100mm and 900 x 900 x 100mm are special order items only. Contact your local Barkman sales representative for further details. The Unit of Measure for Broadway, Planks and Contour 100mm is Each. Broadway Contour 100mm is a special order product. This new product features a striated texture that's slip-resistant and adds a striking accent to any given space.

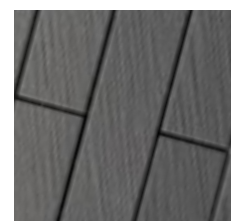
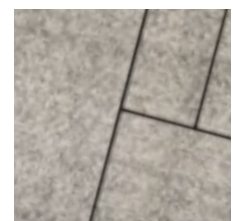
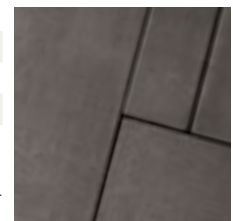

Broadway, Planks and Contour 100mm

PATTERNS

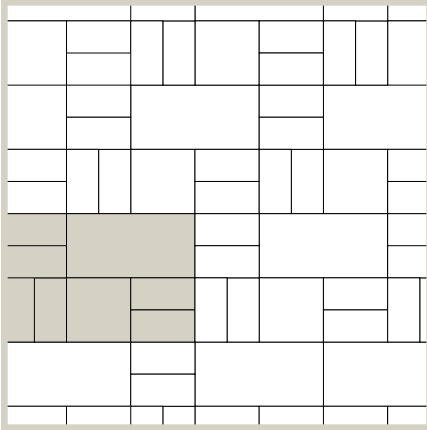

Pattern 1

Pieces per 100 Sqft

- (6) 150 x 300 = 50%, 102 pcs
- (1) 300 x 300 = 17%, 17 pcs
- (1) 600 x 300 = 33%, 17 pcs

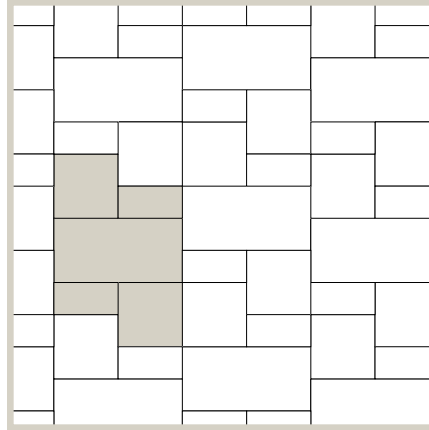

Pattern 2

Pieces per 100 Sqft

- (2) 150 x 300 = 20%, 42 pcs
- (1) 300 x 300 = 40%, 42 pcs
- (1) 600 x 300 = 40%, 21 pcs

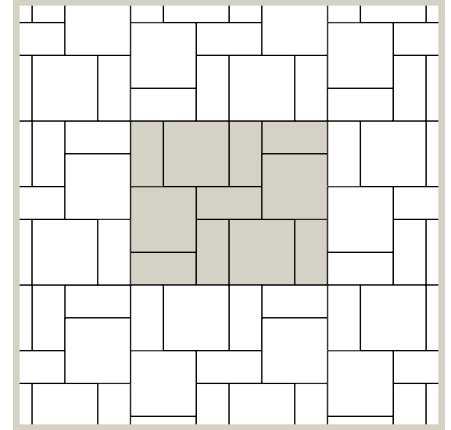

Pattern 3

Pieces per 100 Sqft

- 300 x 300 = 54%, 56 pcs
- 300 x 150 = 46%, 126 pcs

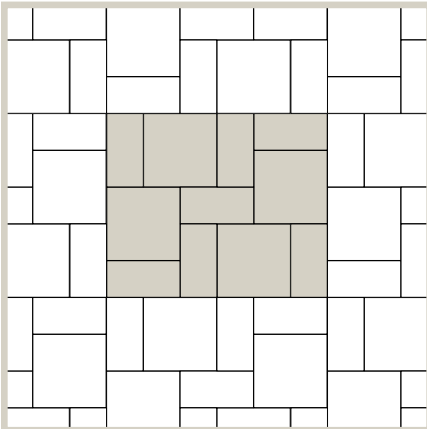

Pattern 4

Pieces per 100 Sqft

- (1) 900 x 900 = 50%, 6 pcs
- (2) 900 x 450 = 50%, 12 pcs

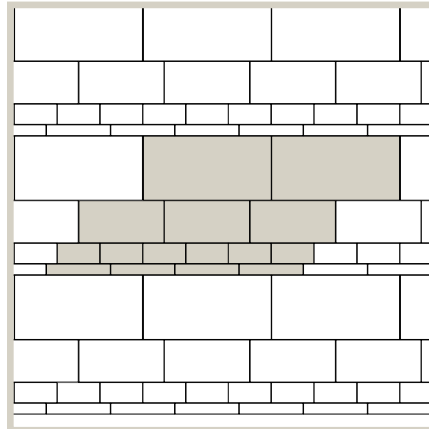

Pattern 5

Pieces per 100 Sqft

- (2) 900 x 450 = 46%, 12 pcs
- (3) 600 x 300 = 31%, 12 pcs
- (6) 300 x 150 = 15%, 36 pcs
- (4) 451 x 76 = 8%, 24 pcs

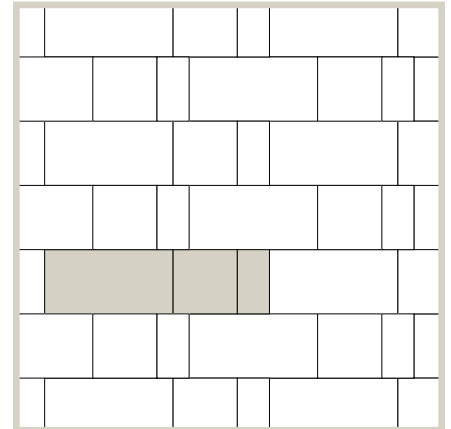

Pattern 6

Pieces per 100 Sqft

- (1) 150 x 300 = 14%, 29 pcs
- (1) 300 x 300 = 29%, 29 pcs
- (1) 600 x 300 = 57%, 29 pcs

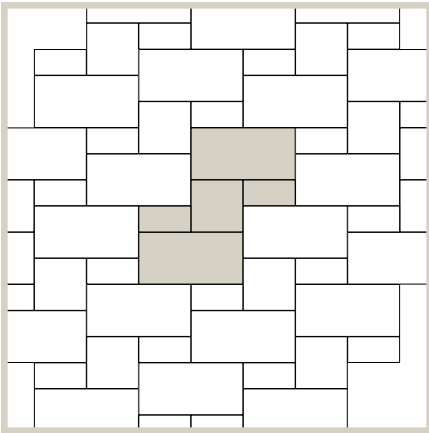

Pattern 7
 Pieces per 100 Sqft
 (2) 300 x 150 = 16.5%, 34 pcs
 (1) 300 x 300 = 16.5%, 17 pcs
 (2) 600 x 300 = 67%, 34 pcs

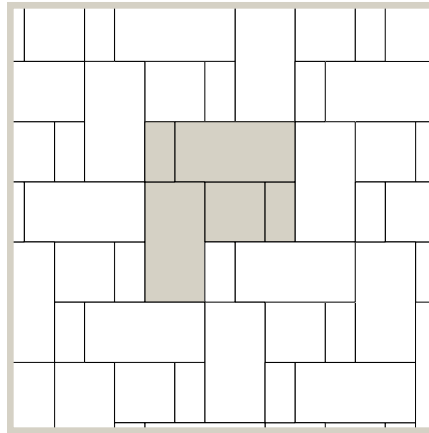

Pattern 8
 Pieces per 100 Sqft
 (2) 300 x 150 = 16.5%, 34 pcs
 (1) 300 x 300 = 16.5%, 17 pcs
 (2) 600 x 300 = 67%, 34 pcs

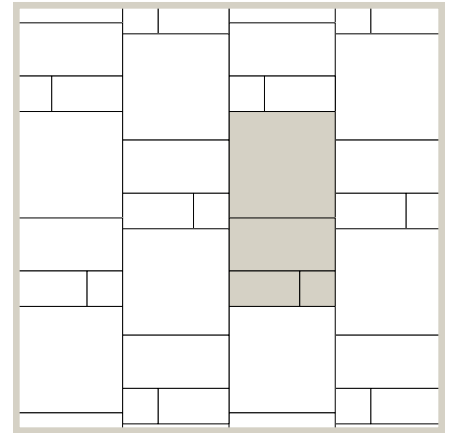

Pattern 9
 Pieces per 100 Sqft
 (1) 900 x 900 = 54%, 7 pcs
 (1) 900 x 450 = 27%, 7 pcs
 (1) 600 x 300 = 13%, 7 pcs
 (1) 300 x 300 = 6%, 7 pcs

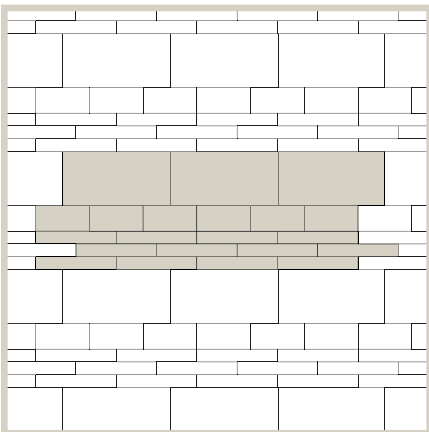

Pattern 10
 Pieces per 100 Sqft
 (3) 600 x 300 = 44.2%, 24 pcs
 (6) 300 x 150 = 22%, 48 pcs
 (12) 451 x 76 = 33.8%, 96 pcs

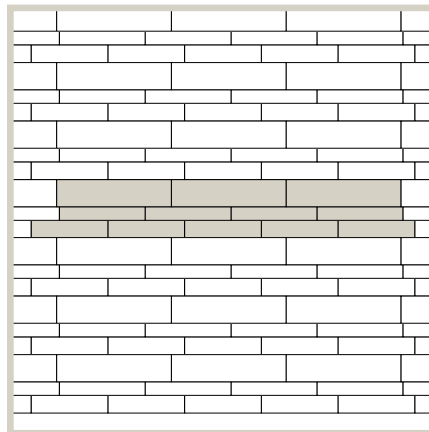

Pattern 11
 Pieces per 100 Sqft
 (6) 600 x 150 = 46%, 48 pcs
 (9) 400 x 100 = 30.6%, 72 pcs
 (8) 451 x 76 = 23.4%, 64 pcs

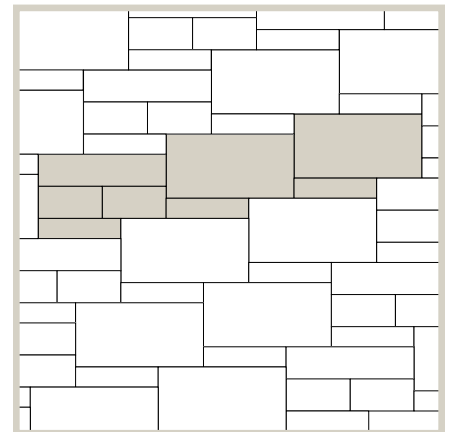

Pattern 12
 Pieces per 100 Sqft
 (2) 600 x 300 = 54.7%, 28 pcs
 (1) 600 x 150 = 13.7%, 14 pcs
 (3) 400 x 100 = 18.1%, 42 pcs
 (2) 300 x 150 = 13.5%, 28 pcs

Colonial Eco

DESCRIPTION	UNIT					PALLET ROW				PALLET				PRICE
	SIZE (L X W X H)		FACE AREA		WEIGHT	NO. OF UNITS	FACE AREA		NO. OF UNITS	NO. OF ROWS	FACE AREA		WEIGHT	
	MM	IN	M2	SQ FT	LB		M2	SQ FT			M2	SQ FT	LB	
Colonial Eco	157 x 157 x 80	6.18 x 6.18 x 3.15	0.03	0.27	9	40	0.99	10.61	280	7	7.02	75.6	2451	

COLOURS	ITEM NO.
Special order	-



Specs: Colonial Eco has 8 horizontal layers per pallet and each layer is 9.45 sq. ft. per layer

Notes: This is a non-stocking item, special order only. Please contact Barkman for colour availability. A \$35.00 returnable pallet fee will be charged to any bundle of Colonial Eco. Special order minimum quantity is 1000 sq ft. Contact your local Barkman sales representative for further details. The Unit of Measure for Colonial Eco is Each.

Holland Eco

DESCRIPTION	UNIT					PALLET ROW				PALLET				PRICE
	SIZE (L X W X H)		FACE AREA		WEIGHT	NO. OF UNITS	FACE AREA		NO. OF UNITS	NO. OF ROWS	FACE AREA		WEIGHT	
	MM	IN	M2	SQ FT	LB		M2	SQ FT			M2	SQ FT	LB	
Holland Eco	210 x 105 x 80	8.27 x 4.13 x 3.15	0.02	0.24	9.05	-	-	-	320 full	-	7.13	76.8	2918	
									64 half					

COLOURS	ITEM NO.
Special order	-



Specs: Holland Eco has 8 horizontal layers per pallet and each layer is 9.6 sq. ft. per layer

Notes: This is a non-stocking item, special order only. Please contact Barkman for colour availability. Each pallet contains 320 full pieces and 64 half pieces. The 64 half stones included in each pallet is not charged. See Holland on page 9 for patterns. A \$35.00 returnable pallet fee will be charged to any bundle of Holland Eco. Special order minimum quantity is 1000 sq ft. Contact your local Barkman sales representative for further details. The Unit of Measure for Holland Eco is Layer.

Turfstone Eco

DESCRIPTION	UNIT					PALLET ROW				PALLET				PRICE
	SIZE (L X W X H)		FACE AREA		WEIGHT	NO. OF UNITS	FACE AREA		NO. OF UNITS	NO. OF ROWS	FACE AREA		WEIGHT	
	MM	IN	M2	SQ FT	LB		M2	SQ FT			M2	SQ FT	LB	
Turfstone Eco	599 x 399 x 80	23.58 x 15.71 x 3.15	0.24	2.56	64.5	16	3.84	40.96	32	2	7.62	81.92	2064	

COLOURS	ITEM NO.
Natural	202846



Specs: Turfstone Eco has 8 horizontal layers per pallet and each layer is 10.24 sq. ft. per layer

Notes: A \$35.00 returnable pallet fee will be charged to any bundle of Turfstone Eco. Contact your local Barkman sales representative for further details. The Unit of Measure for Turfstone Eco is Each.

Paver Material Requirements

1) EXCAVATION DEPTH

MATERIAL	FOR PEDESTRIAN TRAFFIC		FOR LIGHT VEHICULAR TRAFFIC	
	MM	IN	MM	IN
Pavers	60	2.36	60	2.36
Sand	25.4	1	25.4	1
Gravel Base	102-152	4-6	203-305	8-12
Total Excavation Depth	178-229	7-9	279-381	11-15

Gravel base: Use minimum depths in a well-drained area or undisturbed soil. Use maximum depths in poorly drained area or distributed soil. 0.5" less is required to compensate compacting of pavers. If soil is saturated more than 50% of the time, filter fabric and extra base should be used.

When installing thicker pavers add equivalent total excavation depth. Note that not all 60mm pavers are suitable for vehicular traffic.

2) BASE MATERIAL

Granular Base

WIDTH		LENGTH		BASE DEPTH				MATERIAL REQUIRED
m	x	m	x	$m \div 0.3048$	\div	0.6858	=	m^3
ft	x	ft	x	$ft \div 12$	\div	27	=	cu yd

Bedding Sand

WIDTH		LENGTH					MATERIAL REQUIRED
m	x	m	x	0.0255	=		m^3
ft	x	ft	x	0.0031	=		cu yd

3) EDGING

Edging

LENGTH OF EDGE				SNAP EDGE
m	\div	2.4384	=	No. of Pieces
ft	\div	8	=	No. of Pieces

Spikes

LENGTH OF EDGE				SPIKES
m	\div	3.2808	=	No. of Spikes
ft	x	1	=	No. of Spikes



SLABS

From the rustic wood grains of Bridgewood to the bold colours and textures of Lexington, Barkman offers a wide variety of slabs to suit any architectural style.

Arborwood

DESCRIPTION	UNIT					PALLET					PRICE
	SIZE (L X W X H)		FACE AREA		WEIGHT	NO. OF HORIZONTAL LAYERS	NO. OF UNITS	FACE AREA		WEIGHT	
	MM	IN	M2	SQ FT	LB			M2	SQ FT	LB	
Arborwood	800 x 200 x 60	31.5 x 7.87 x 2.36	0.16	1.72	48.83	10	50	8	86.11	2441	

COLOURS	ITEM NO.
Kodiak Brown	138915
Timber Wolf Grey	138916

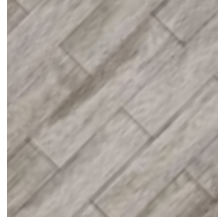

Notes: Available to order in full pallets only. A \$35.00 returnable pallet fee will be charged to any bundle of Arborwood. When installing this product, make sure to include a 2-5mm gap between each unit. This will provide enough room for the jointing sand and make installation easier. The Unit of Measure for Arborwood is Each.

PATTERNS

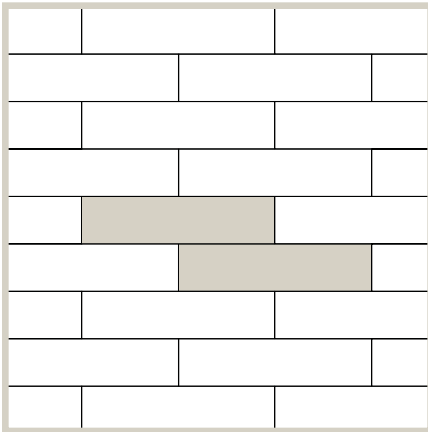

1/2 Offset
 Pieces per 100 Sqft
 59 pieces Arborwood = 100% of total area

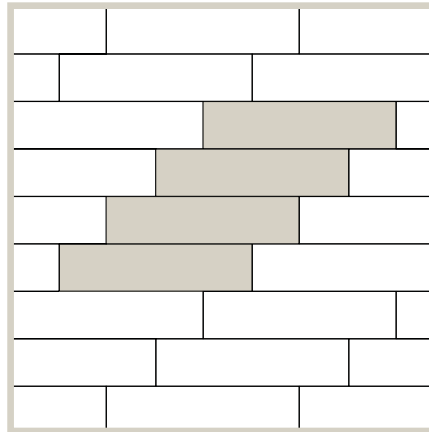

1/4 Offset
 Pieces per 100 Sqft
 59 pieces Arborwood = 100% of total area

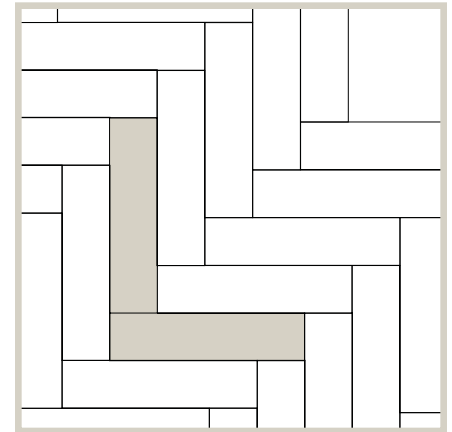

Herringbone
 Pieces per 100 Sqft
 59 pieces Arborwood = 100% of total area

Bridgewood

DESCRIPTION	UNIT					PALLET					PRICE
	SIZE (L X W X H)		FACE AREA		WEIGHT	NO. OF UNITS	NO. OF ROWS	FACE AREA		WEIGHT	
	MM	IN	M2	SQ FT	LB			M2	SQ FT	LB	
17 x 10	440 x 250 x 51	17.32 x 9.84 x 2	0.11	1.18	28.5	40	-	4.39	47.2	1140	
23 x 10	595 x 250 x 51	23.43 x 9.84 x 2	0.15	1.6	38.5	20	-	2.97	32	770	
35 x 10	890 x 250 x 51	35.04 x 9.84 x 2	0.22	2.39	58	20	-	4.45	47.9	1160	

COLOURS	ITEM NO. 17X10	ITEM NO. 23X10	ITEM NO. 35X10
Cedar Brown	114278	114280	114282
Weathered Grey	114277	114279	114281



Notes: Available to order in full pallets. Bridgewood should incorporate a 1/8" to 1/4" (3mm to 6mm) gap between each plank. Plank thicknesses will vary; this is intentional to replicate real planks. Can be laid with all three sizes, or a selection of one or two at any size in a running bond pattern. To achieve the most desired look, Bridgewood is intended to be laid in all three sizes with a 1:1:1 ratio. To calculate number of pieces, Area / 5.17 = how many pieces required. A \$35.00 returnable pallet fee will be charged to any bundle of Bridgewood. The Unit of measure for Bridgewood is Each.

PATTERNS

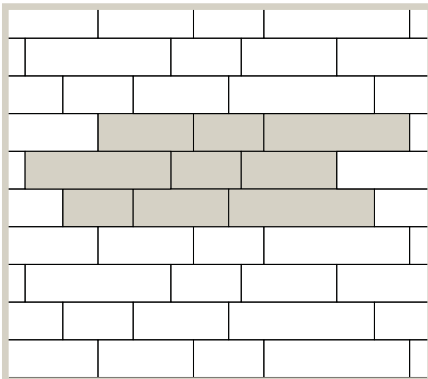

Pieces per 100 sq. ft.
 20 pieces: 17 x 10 = 23% of total area
 20 pieces: 24 x 10 = 31% of total area
 20 pieces: 35 x 10 = 46% of total area

Brookside

DESCRIPTION	UNIT					PALLET					PRICE
	SIZE (L X W X H)		FACE AREA		WEIGHT	NO. OF HORIZONTAL LAYERS	NO. OF UNITS	FACE AREA		WEIGHT	
	MM	IN	M2	SQ.FT	LB			M2	SQ.FT	LB	
16 x 16	400 x 400 x 50	15.75 x 15.75 x 1.97	0.16	1.72	40.68	7	42	6.72	72.33	1709	
16 x 24	400 x 600 x 50	15.75 x 23.62 x 1.97	0.24	2.58	61.02	10	40	9.60	103.33	2441	

COLOURS	ITEM NO. 16X16	ITEM NO. 16X24
Charcoal	123705	123709
Sierra Grey	123707	123710
Hazel	123708	123711



Notes: Available to order in full pallets only. A \$35.00 returnable pallet fee will be charged to any bundle of Brookside. When installing this product, make sure to include a 2–5mm gap between each unit. This will provide enough room for the jointing sand and make installation easier. The Unit of measure for Bridgewood is Each.

PATTERNS

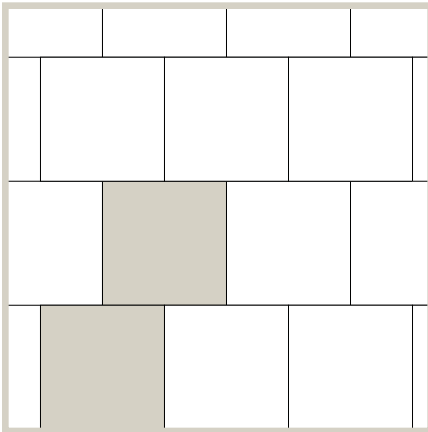

Running Bond 1
 Pieces per 100 sq. ft.
 59 pieces: 16 x 16 = 100% of total area

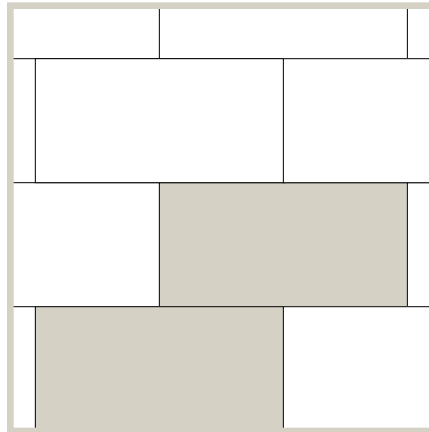

Running Bond 2
 Pieces per 100 sq. ft.
 39 pieces: 16 x 24 = 100% of total area

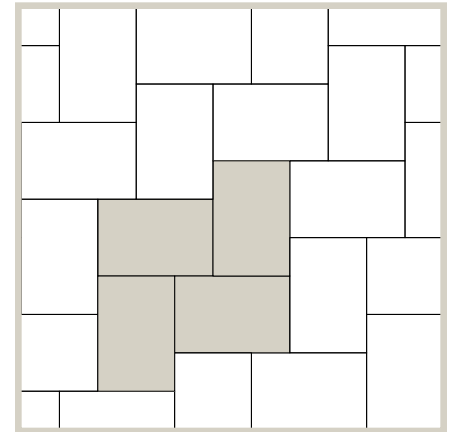

Herringbone
 Pieces per 100 sq. ft.
 39 pieces: 16 x 24 = 100% of total area

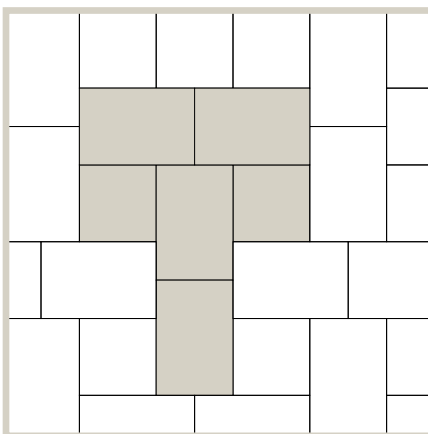

Pattern 1
 Pieces per 100 sq. ft.
 15 pieces: 16 x 16 = 25% of total area
 29 pieces: 16 x 24 = 75% of total area

Diamond Face

DESCRIPTION	UNIT					PALLET					PRICE
	SIZE (L X W X H)		FACE AREA		WEIGHT	NO. OF HORIZONTAL LAYERS	NO. OF UNITS	FACE AREA		WEIGHT	
	MM	IN	M2	SQ FT	LB			M2	SQ FT	LB	
18 x 18	457 x 457 x 51	18 x 18 x 2	0.21	2.25	53.95	10	40	8.35	89.92	2158	
24 x 24	610 x 610 x 51	24 x 24 x 2	0.37	4	96.13	10	20	7.44	80	1923	
24 x 30	610 x 762 x 51	24 x 30 x 2	0.46	5	120.08	10	20	9.30	100.07	2402	

COLOURS	ITEM NO. 18X18	ITEM NO. 24X24	ITEM NO. 24X30
Natural	140159	140158	140157

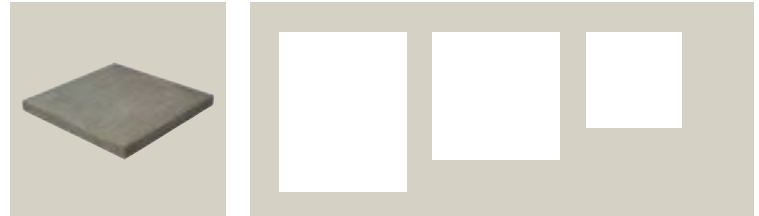

Notes: Available to order in full bundles only. A \$35.00 returnable pallet fee will be charged to any bundle of Diamond Face. When installing this product, make sure to include a 2-5mm gap between each unit. This will provide enough room for the jointing sand and make installation easier. The Unit of Measure for Diamond Face is Each.

Footing Pads

DESCRIPTION	UNIT					PALLET					PRICE
	SIZE (L X W X H)		FACE AREA		WEIGHT	NO. OF HORIZONTAL LAYERS	NO. OF UNITS	FACE AREA		WEIGHT	
	MM	IN	M2	SQ FT	LB			M2	SQ FT	LB	
12 x 12 x 4	305 x 305 x 102	12 x 12 x 4	-	-	49	5	60	-	-	2940	
18 x 18 x 4	457 x 457 x 102	18 x 18 x 4	-	-	113	6	24	-	-	2712	
18 x 18 x 6	457 x 457 x 152	18 x 18 x 6	-	-	164	5	20	-	-	3280	
24 x 24 x 6	610 x 610 x 152	24 x 24 x 6	-	-	290	4	8	-	-	2320	

COLOURS	ITEM NO. 12X12X4	ITEM NO. 18X18X4	ITEM NO. 18X18X6	ITEM NO. 24X24X6
Natural	105895	105899	105900	105906



Notes: Indent for post T slot on 12" x 12" x 4" and 18" x 18" x 4" is 1". Available to order in full pallets only. A \$35.00 returnable pallet fee will be charged to any bundle of Footing Pads. The Unit of Measure for Footing Pads is Each. The Unit of Measure for Lexington is Each.

Lexington

DESCRIPTION	UNIT					PALLET					PRICE
	SIZE (L X W X H)		FACE AREA		WEIGHT	NO. OF HORIZONTAL LAYERS	NO. OF UNITS	FACE AREA		WEIGHT	
	MM	IN	M2	SQ FT	LB			M2	SQ FT	LB	
16 x 16	400 x 400 x 50	15.75 x 15.75 x 1.97	0.16	1.72	40.68	7	42	6.72	72.33	1709	
16 x 24	400 x 600 x 50	15.75 x 23.62 x 1.97	0.24	2.58	61.02	10	40	9.6	103.33	2441	

COLOURS	ITEM NO. 16X16	ITEM NO. 16X24
Sandstone	123714	123717
Sterling	123712	123715
Flint	123713	123716



Notes: Available to order in full pallets only. A \$35.00 returnable pallet fee will be charged to any bundle of Lexington. When installing this product, make sure to include a 2-5mm gap between each unit. This will provide enough room for the jointing sand and make installation easier.

PATTERNS

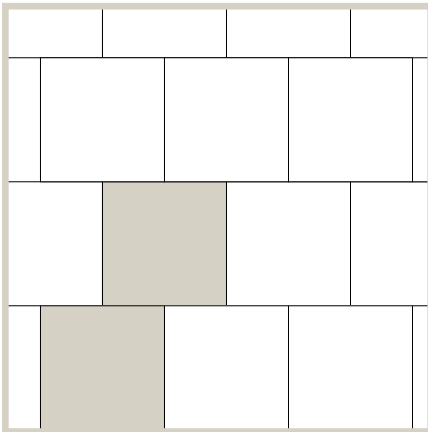

Running Bond 1
 Pieces per 100 sq. ft.
 59 pieces: 16 x 16 = 100% of total area

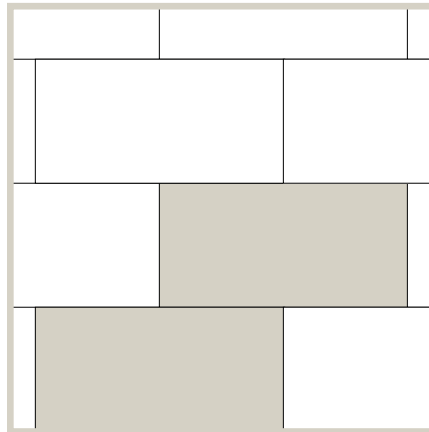

Running Bond 2
 Pieces per 100 sq. ft.
 39 pieces: 16 x 24 = 100% of total area

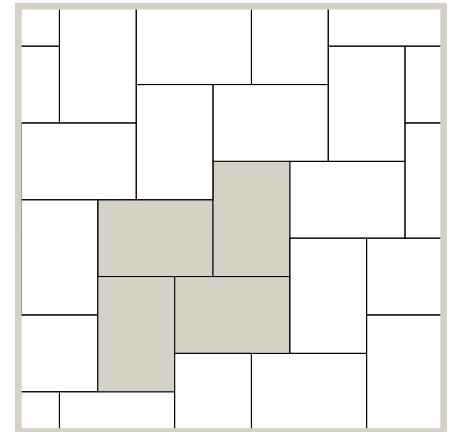

Herringbone
 Pieces per 100 sq. ft.
 39 pieces: 16 x 24 = 100% of total area

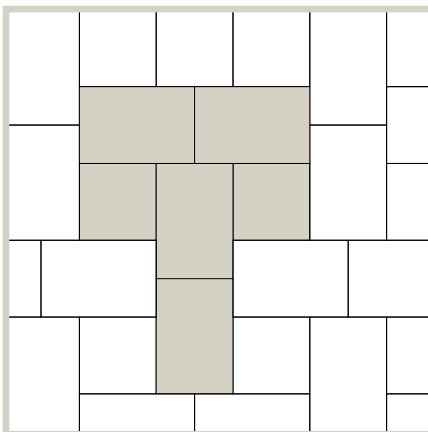

Pattern 1
 Pieces per 100 sq. ft.
 15 pieces: 16 x 16 = 25% of total area
 29 pieces: 16 x 24 = 75% of total area

Rosetta® Dimensional Flagstone

DESCRIPTION	UNIT					NO. OF HORIZONTAL LAYERS	PALLET				PRICE
	SIZE (L X W X H)		FACE AREA		WEIGHT		NO. OF UNITS	FACE AREA		WEIGHT	
	MM	IN	M2	SQ FT	LB			M2	SQ FT	LB	
12 x 6	305 x 152 x 51	12 x 6 x 2	0.05	0.5	11.99	8	8	9.10	98	2350	
12 x 12	305 x 305 x 51	12 x 12 x 2	0.09	1	23.97		8				
12 x 18	305 x 457 x 51	12 x 18 x 2	0.14	1.5	35.95		8				
18 x 18	457 x 457 x 51	18 x 18 x 2	0.21	2.25	53.96		8				
18 x 24	457 x 610 x 51	18 x 24 x 2	0.28	3	71.94		8				
24 x 24	610 x 610 x 51	24 x 24 x 2	0.37	4	95.91		8				

COLOURS	ITEM NO.
Fond du Lac	241426
Copper Canyon	241425
Pacific Grey	241428
Northern Charcoal	241427

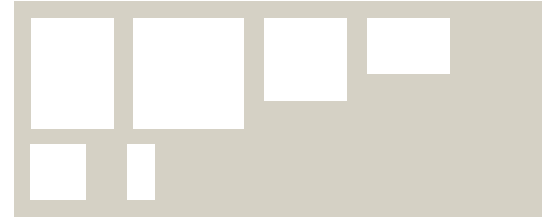

Notes: Available to order in full pallets only. Pallet contains all slab sizes. A \$35.00 returnable pallet fee will be charged to any bundle of Dimensional Flagstone. Make sure to include a 1/4" to 3/8" (6mm to 10mm) joint gap between each unit for easier installation. There are 8 layers per pallet and one of each piece per layer. The Unit of Measure for Dimensional Flagstone is Layer.

PATTERNS

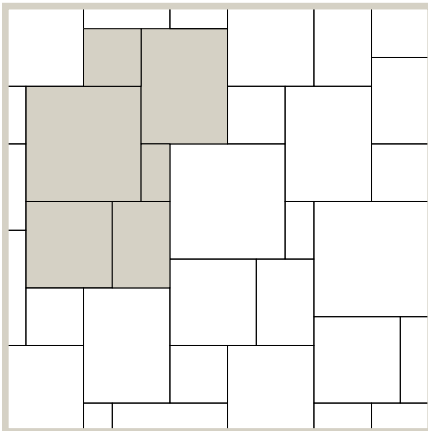

Random Pattern

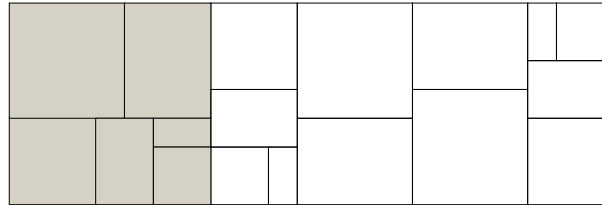

Walkway

Rosetta® Grand Flagstone

DESCRIPTION	UNIT						PALLET					PRICE
	SIZE (L X W X H)		FACE AREA		WEIGHT	NO. OF HORIZONTAL LAYERS	NO. OF UNITS	FACE AREA		WEIGHT		
	MM	IN	M2	SQ FT	LB			M2	SQ FT	LB		
Rosetta® Grand Flagstone	1067 x 965 x 51	42 x 38 x 2	-	-	-	8	24-32	8.36	90	2000		

COLOURS	ITEM NO.
Fond du Lac	241430
Copper Canyon	241429
Pacific Grey	241432
Northern Charcoal	241431

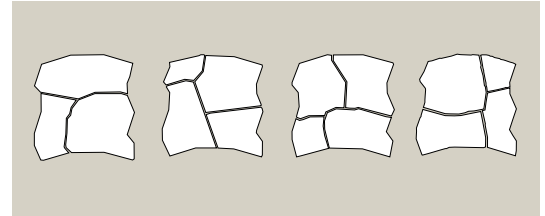

Notes: Measurements (42 x 38 x 2) based on layer configuration. Three to four pieces per layer. Eight layers per pallet, one shape per layer. Available to order in full pallets only. A \$35.00 returnable pallet fee will be charged to any bundle of Grand Flagstone. Make sure to include a 1/4" to 3/8" (6mm to 10mm) joint gap between each unit for easier installation. The Unit of Measure for Grand Flagstone is Layer.

PATTERNS

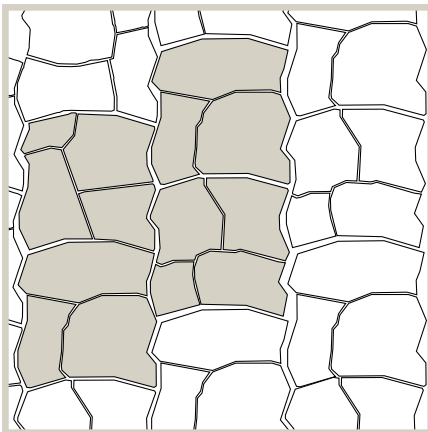

Pattern with All Four Layers

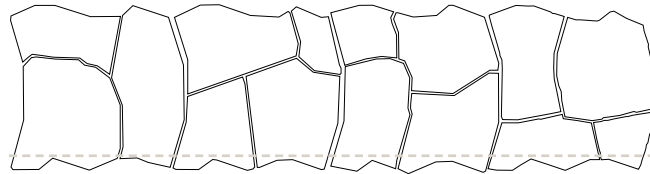

Walkway
Optional: Trim Edges for Straight Lines

Stepping Stones

DESCRIPTION	UNIT						PALLET					PRICE
	SIZE (L X W X H)		FACE AREA		WEIGHT	NO. OF HORIZONTAL LAYERS	NO. OF UNITS	FACE AREA		WEIGHT		
	MM	IN	M2	SQ FT	LB			M2	SQ FT	LB		
Broadway	300 x 300 x 65	11.81 x 11.81 x 2.56	0.09	0.97	29.75	10	90	8.10	87.3	2678		

COLOURS FACE MIX	ITEM NO. 300 X 300 X 65
Natural	234989
Ash	241041
Charcoal	234993
Sterling	234997
Sandstone	241044
Amber	239852
Quartz	236644
Sierra Grey (BC Only)	143650
Graphite (BC Only)	143654



Notes: Broadway 300 x 300 x 65mm can be used as a Stepping Stone. Available to order in full pallets only. A \$35.00 returnable pallet fee will be charged to any bundle. Special order minimum quantity is 1000 sq ft per size. Contact your local Barkman sales representative for further details. The Unit of Measure for Stepping Stones is Each



Terrace NEW BC-EXCLUSIVE

DESCRIPTION	UNIT					PALLET					PRICE
	SIZE (L X W X H)		FACE AREA		WEIGHT	NO. OF HORIZONTAL LAYERS	NO. OF UNITS	FACE AREA		WEIGHT	
	MM	IN	M2	SQ FT	LB			M2	SQ FT	LB	
24 x 24	610 x 610 x 51	24 x 24 x 2	0.37	4	96.13	10	20	7.44	80	1923	

COLOURS	ITEM NO. 24X24
Natural	143647
Charcoal	143648
Graphite	143707

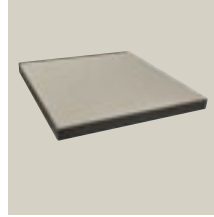

Notes: This product is for BC only. Terrace Slab uses pedestals for rooftop applications. Available to order in full bundles only. A \$35.00 returnable pallet fee will be charged to any bundle of Terrace Slab. The Unit of Measure for Diamond Face is Each.

PATTERNS

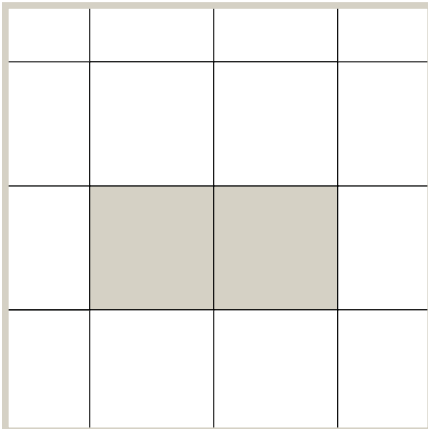

Straight

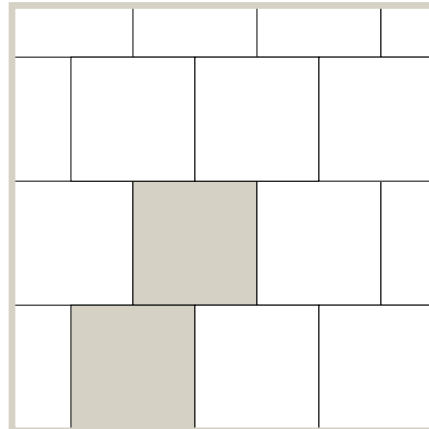

Running Bond



WALLS & STEPS

Barkman's wide selection of retaining walls are as versatile as they are stylish. Build small planter boxes and garden walls with Quarry Stone or our Bridgewood Wall. Erect large commercial retaining walls quickly with Rosetta® Outcropping or our Keystone Compac III wall. Whatever your project, Barkman has the wall system for you.

Architextures™

DESCRIPTION	UNIT					PALLET					PRICE
	SIZE (H X W X D)		FACE AREA		WEIGHT	NO. OF HORIZONTAL LAYERS	NO. OF UNITS	FACE AREA		WEIGHT	
	MM	IN	M2	SQ FT	LB			M2	SQ FT	LB	
Standard	150 x 900 x 285	5.9 x 35.43 x 11.22	0.13	1.45	188.77	3	15	2.02	21.80	2832	
Coping	150 x 900 x 285	5.9 x 35.43 x 11.22	0.13	1.45	189.9	3	15	2.02	21.80	2849	
Corner	150 x 900 x 285	5.9 x 35.43 x 11.22	0.13	1.45	184.14	2	10	1.35	14.53	1841	

COLOURS	ITEM NO. STANDARD	ITEM NO. COPING	ITEM NO. CORNER
Flint	134824	137750	134830
Sterling	134825	137752	134831
Ash	134826	137751	134832



Notes: Every bundle of coping units will come with 6 left end coping units, 6 right end coping units and 3 regular coping units which have open ends. Available to order in full pallets only. A \$35.00 returnable pallet fee will be charged to any bundle of Architextures. This product can be mechanically installed. To calculate pieces required, multiply the wall length, in feet, by 0.338. This will give you the number of pieces required per layer. Then multiply this by the number of layers to determine total quantity required. Please note that 0.338 is the multiplier used for both the standard and coping units. The Unit of Measure for Architextures is Each

Architextures™ Atlas

DESCRIPTION	UNIT					PALLET					PRICE
	SIZE (H X W X D)		FACE AREA		WEIGHT	NO. OF HORIZONTAL LAYERS	NO. OF UNITS	FACE AREA		WEIGHT	
	MM	IN	M2	SQ FT	LB			M2	SQ FT	LB	
Atlas Standard	150 x 900 x 285	5.9 x 35.43 x 11.22	0.13	1.45	188.77	3	15	2.02	21.80	2832	
Atlas Coping	150 x 900 x 285	5.9 x 35.43 x 11.22	0.13	1.45	189.9	3	15	2.02	21.80	2849	
Atlas Corner	150 x 900 x 285	5.9 x 35.43 x 11.22	0.13	1.45	184.14	2	10	1.35	14.53	1841	

COLOURS	ITEM NO. STANDARD	ITEM NO. COPING	ITEM NO. CORNER
Sterling	139770-SO	139771-SO	139772-SO

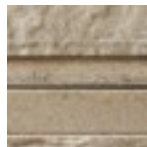

Notes: Every bundle of coping units will come with 6 left end coping units, 6 right end coping units and 3 regular coping units which have open ends. Available to order in full pallets only. A \$35.00 returnable pallet fee will be charged to any bundle of Architextures. This product can be mechanically installed. To calculate pieces required, multiply the wall length, in feet, by 0.338. This will give you the number of pieces required per layer. Then multiply this by the number of layers to determine total quantity required. Please note that 0.338 is the multiplier used for both the standard and coping units. Note that the closed end coping does not have the texture as the face does. Architecture Atlas is a special order product. The Unit of Measure for Architextures is Each

Bridgewood Wall

DESCRIPTION	UNIT					PALLET					PRICE
	SIZE (H X W X D)		FACE AREA		WEIGHT	NO. OF HORIZONTAL LAYERS	NO. OF UNITS	FACE AREA		WEIGHT	
	MM	IN	M2	SQ FT	LB			M2	SQ FT	LB	
Bridgewood Wall	152 x 1067 x 203	6 x 42 x 8	0.16	1.75	171	3	15	2.44	26.25	2526	

COLOURS	ITEM NO.
Cedar Brown	138331
Weathered Grey	138332



Notes: Available to order in full pallets only. A \$35.00 returnable pallet fee will be charged to any bundle of Bridgewood Wall. To calculate pieces required, multiply the wall length, in feet, by 0.285. This will give you the number of pieces required per layer. Then multiply this by the number of layers to determine total quantity required. The Unit of Measure for Bridgewood Wall is Each.

Keystone Compac® III

DESCRIPTION	UNIT					PALLET						PRICE
	SIZE (H X W X D)		FACE AREA		WEIGHT	NO. OF HORIZONTAL LAYERS	NO. OF UNITS	NO. OF ROWS	FACE AREA		WEIGHT	
	MM	IN	M2	SQ FT	LB				M2	SQ FT	LB	
Keystone Compac III Hewnstone Standard	203 x 457 x 305	8 x 18 x 12	0.09	1	77.88	5	30	-	2.78	29.96	2336	
Keystone Compac III Hewnstone Corner	203 x 457.2 x 228.6	8 x 18 x 9	-	-	104	3	18	-	1.67	17.97	1872	
Coping	100 x 450 x 300	3.94 x 17.72 x 11.81	-	-	66	6	48	2	21.95 linear metres	72 linear feet	3168	
Fiberglass Alignment Pins	13 x 133	0.5 x 5.25	-	-	0.08		100/box	-	-	-	7.9/box	

COLOURS	ITEM NO. STANDARD	ITEM NO. CORNER	ITEM NO. COPING	ITEM NO. FIBERGLASS PINS
Charcoal	139848	134788	134799	123168
Sierra Grey	139849	134789	136462	-
Natural	142313	142312	142314	-
Graphite (BC only)	143708	143709		



Notes: Sold in full pallets only. A \$35.00 returnable pallet fee will be charged to any bundle of Keystone Compac III – Hewnstone. Use 2 fiberglass pins per block to connect. For near vertical batter, place pins in front hole location. For 8.5 degree batter, place pins in back hole location. For 4 degree batter, alternate pin location starting with back pin location on first course, front location on second course and alternating on consecutive layers. Alignment pins sold separately. The Unit of Measure for Keystone Compac III is Each.

MagnumStone™

DESCRIPTION	UNIT					PALLET ROW			PALLET				PRICE	
	SIZE (H X W X D)		FACE AREA		WEIGHT	NO. OF UNITS	FACE AREA		NO. OF UNITS	NO. OF ROWS	FACE AREA			WEIGHT
	MM	IN	M2	SQ FT	LB		M2	SQ FT			M2	SQ FT		LB
Base Unit	610 x 1219 x 610	24 x 48 x 24	0.745	8	1450	-	-	-	2	-	-	-	2900	
Standard Unit	610 x 1219 x 610	24 x 48 x 24	0.745	8	1450	-	-	-	2	-	-	-	2900	
Top Unit	610 x 1219 x 610	24 x 48 x 24	0.745	8	1450	-	-	-	2	-	-	-	2900	
Half High Base Unit	305 x 1219 x 610	12 x 48 x 24	0.37	4	700	-	-	-	2	-	-	-	1400	
Half High Standard Unit	305 x 1219 x 610	12 x 48 x 24	0.37	8	700	-	-	-	2	-	-	-	1400	
Half High Top Unit	305 x 1219 x 610	12 x 48 x 24	0.37	8	680	-	-	-	2	-	-	-	1360	
Corner/End Unit	610 x 610	24 x 24	0.434	4.66	180	-	-	-	4	-	-	-	720	
Half High Corner/End Unit	305 x 610	12 x 24	0.217	2.33	100	-	-	-	8	-	-	-	800	
Step/Cap Unit	152.5 x 1219.2 x 609.6	6 x 48 x 24	0.186	2	600	-	-	-	8	-	-	-	4800	

COLOURS	ITEM NO. BASE UNIT	ITEM NO. STANDARD UNIT	ITEM NO. TOP UNIT	ITEM NO. HALF HIGH BASE UNIT	ITEM NO. HALF HIGH STANDARD UNIT	ITEM NO. HALF HIGH TOP UNIT	ITEM NO. RIGHT CORNER/END UNIT	ITEM NO. LEFT CORNER/END UNIT	ITEM NO. RIGHT HALF HIGH CORNER/END UNIT	ITEM NO. LEFT HALF HIGH CORNER/END UNIT	ITEM NO. STEP/CAP UNIT
Ledgestone Face Natural Grey	121756	121755	121757	121759	121758	121760	122526	122528			115202
Boulder Face Natural Grey	115227	115226	115228	115324	115323	115325	122522	122523	122524	122525	115202



2' Extender



4' Extender



Standard Unit

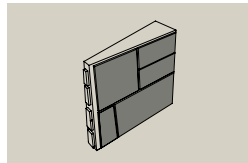

Right Hand Corner Unit

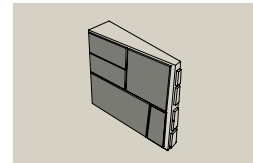

Left Hand Corner Unit



Ledgestone Face

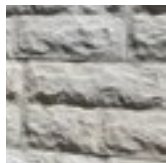

Boulder Face

Notes: Weights may vary depending on face type. All 24 x 48 and 12 x 48 blocks can be custom ordered with drain hole as required. The 24 x 48 and 12 x 48 Top Block Units can also be custom ordered as base units (no lugs). Please ask your local sales rep regarding MagnumStone orders. The Unit of Measure for MagnumStone is Each.

Quarry Stone

DESCRIPTION	UNIT					PALLET ROW				PALLET				PRICE
	SIZE (H X W X D)		FACE AREA		WEIGHT	NO. OF UNITS	FACE AREA		NO. OF UNITS	NO. OF ROWS	FACE AREA		WEIGHT	
	MM	IN	M2	SQ FT	LB		M2	SQ FT			M2	SQ FT	LB	
Standard	102 x 305 x 203	4 x 12 x 8	0.03	0.33	31	24	0.74	7.92	96	4	2.94	31.68	2976	
Smooth Standard	102 x 305 x 203	4 x 12 x 8	0.03	0.33	31	24	0.74	7.92	72	3	2.16	23.76	2232	

COLOURS	ITEM NO. STANDARD	SMOOTH STANDARD
Charcoal	103789	103790
Sierra Grey	103791	-



Standard

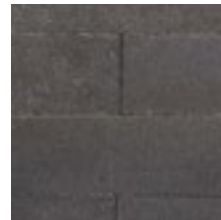

Smooth Standard



Specs:

Quarry Stone - 6 horizontal layers per pallet

Smooth Quarry Stone - 3 horizontal layers per pallet

Notes: It is recommended to go a maximum wall height of 2' high. A \$35.00 returnable pallet fee will be charged to any bundle of Quarry Stone. The Unit of Measure for Quarry Stone is Each.

RomanStack®

DESCRIPTION	UNIT					PALLET ROW				PALLET				PRICE
	SIZE (H X W X D)		FACE AREA		WEIGHT	NO. OF UNITS	FACE AREA		NO. OF UNITS	NO. OF ROWS	FACE AREA		WEIGHT	
	MM	IN	M2	SQ FT	LB		M2	SQ FT			M2	SQ FT	LB	
Standard	102 x 203/152 x 203	4 x 8/6 x 8	0.02	0.22	18	24	0.5	5.35	120	5	2.48	26.75	2160	
Coping	102 x 203/152 x 203	4 x 8/6 x 8	0.02	0.22	18	24	0.5	5.35	120	5	2.48	26.75	2160	
Advanced Corner	102 x 280/203 x 203	4 x 11/8 x 8	0.02	0.22	27	12	-	-	48	4	0.99	10.7	1296	

COLOURS	ITEM NO. STANDARD	ITEM NO. COPING	ITEM NO. CORNER
Charcoal	103901	103902	104262
Desert Buff	103924	103925	104266
Sierra Grey	103919	103920	104264



Specs:

RomanStack Advanced Corner - 3 horizontal layers per pallet

RomanStack Standard and Coping- 6 horizontal layers per pallet

Notes: To calculate pieces required, multiply the wall length, in feet, by 1.72. This will give you the number of pieces required per layer. Then multiply this by the number of layers to determine total quantity required. Please note that 1.72 is the multiplier used for both the standard and coping units. It's recommended to go a maximum of 2' height. Minimum inside diameter of 42" (23 pieces). A \$35.00 returnable pallet fee will be charged to any bundle of RomanStack. The Unit of Measure for Quarry Stone is Each.



Rosetta® Belvedere

DESCRIPTION	UNIT					PALLET						PRICE
	SIZE (H X W X D)		FACE AREA		WEIGHT	NO. OF HORIZONTAL LAYERS	NO. OF UNITS	NO. OF ROWS	FACE AREA		WEIGHT	
	MM	IN	M2	SQ FT	LB				M2	SQ FT	LB	
Wall Pallet	152 x 457/406 x 229	6 x 18/16 x 9	0.07	0.75	-	3	12	-	2.51	27	2475	
	152 x 305/254 x 229	6 x 12/10 x 9	0.05	0.50	-	3	12	-				
	152 x 152/102 x 229	6 x 6/4 x 9	0.02	0.25	-	3	12	-				
	76 x 457/406 x 229	3 x 18/16 x 9	0.03	0.375	-	3	12	-				
	76 x 305/254 x 229	3 x 12/10 x 9	0.02	0.25	-	3	12	-				
	76 x 152/102 x 229	3 x 6/4 x 9	0.01	0.125	-	3	12	-				
Corner Pallet	76 x 381/356 x 229	6 x 15/14 x 9	0.06	1	-	2	16	-	2.23	24	1520	
	76 x 381/356 x 229	3 x 15/14 x 9	0.03	0.5	-	2	16	-				

DESCRIPTION	UNIT					PALLET					PRICE
	SIZE (H X W X D)		FACE AREA		WEIGHT	NO. OF HORIZONTAL LAYERS	NO. OF UNITS	LENGTH		WEIGHT	
	MM	IN	M2	SQ FT	LB			M	FT	LB	
Coping Pallet	57 x 457/406 x 260	2.25 x 18/16 x 10.25	-	-	-	3	6	10.06	33	775	
	57 x 457/432 x 260	2.25 x 18/17 x 10.25	-	-	-	3	6				
	57 x 305/254 x 260	2.25 x 12/10 x 10.25	-	-	-	3	12				
	57 x 152/102 x 260	2.25 x 6/4 x 10.25	-	-	-	3	12				

COLOURS	ITEM NO. WALL	ITEM NO. CORNER	ITEM NO. COPING
Fond du Lac	204038	204045	204049
Copper Canyon	204040	204047	204051
Pacific Grey	204041	204048	204052
Northern Charcoal	238106	238107	238108



Notes: Rosetta Belvedere Walls are replicated from real stone moulds. Barkman uses enhanced manufacturing techniques to mitigate any height variation, however, some shimming may be required in installing this product. A pair consists of a layer of 3" wall units and a layer of 6" wall units combined. The Belvedere wall pallet has 3 Pairs which is 3 horizontal layers. The Unit of Measure for Belvedere Wall Coping and Corner pallets is Layer Pair. A Layer Pair consists of a layer of 3" wall units and a layer of 6" wall units combined. The Unit of Measure for Belvedere Coping pallets is Layer, as the coping units are all a consistent height.

Rosetta® Dimensional Wall

DESCRIPTION	UNIT					PALLET					PRICE
	SIZE (H X W X D)		FACE AREA		WEIGHT	NO. OF HORIZONTAL LAYERS	NO. OF UNITS	FACE AREA		WEIGHT	
	MM	IN	M2	SQ FT	LB			M2	SQ FT	LB	
Straight	102 x 305 x 203	4 x 12 x 8	0.03	0.333	28	5	75	2.32	25	2100	
Wedge	102 x 305/229 x 203	4 x 12/9 x 8	0.03	0.333	24	5	75	2.32	25	1800	

DESCRIPTION	UNIT					PALLET					PRICE
	SIZE (H X W X D)		FACE AREA		WEIGHT	NO. OF HORIZONTAL LAYERS	NO. OF UNITS	LENGTH		WEIGHT	
	MM	IN	M2	SQ FT	LB			M	FT	LB	
Coping	64 x 610 x 318	2.50 x 24 x 12.50	-	-	-	3	9				
	64 x 457 x 318	2.50 x 18 x 12.50	-	-	-	3	6	9.6	31	975	
	64 x 483 x 318	2.50 x 19 x 12.50	-	-	-	3	3				

COLOURS	ITEM NO. WALL	ITEM NO. WEDGE	ITEM NO. COPING
Fond du Lac	204076	204079	204082
Copper Canyon	204075	204078	204081
Pacific Grey	204077	204080	204083
Northern Charcoal	238109	238110	238111



Notes: Recommended maximum wall height is 2'. Available to order in full pallets only. A \$35.00 returnable pallet fee will be charged in any bundle of Dimensional Wall. The Unit of Measure for Dimensional Coping is Layer. The Unit of Measure for Dimensional Wall Straight and Wedge is Each.

Rosetta® Kodah

DESCRIPTION	UNIT					PALLET					PRICE	
	SIZE (H X W X D)		FACE AREA		WEIGHT	NO. OF HORIZONTAL LAYERS	NO. OF UNITS	NO. OF ROWS	FACE AREA			WEIGHT
	MM	IN	M2	SQ FT	LB				M2	SQ FT		LB
Wall Pallet	152 x 305 x 267	6 x 12 x 10.5	0.05	0.5	57	3	3	3	1.95	21	2400	
	152 x 533 x 267	6 x 21 x 10.5	0.08	0.875	100	3	6					
	152 x 762 x 267	6 x 30 x 10.5	0.12	1.25	142	3	3					
	152 x 1067 x 267	6 x 42 x 10.5	1.6	1.75	200	3	6					
Corner Pallet	152 x 533 x 267	6 x 21 x 10.5	0.12	1.34	100	2	16	2	1.95	21	1600	

COLOURS	ITEM NO. WALL	ITEM NO. CORNER
Copper Canyon	241441	241437
Fond du Lac	241442	241438
Pacific Grey	241444	241440
Northern Charcoal	241443	241439



Notes: Available to order in full pallets only. A \$35.00 returnable pallet fee will be charged to any bundle of Rosetta Kodah. Kodah pieces are tapered. Minimum 8.5' radius. The Unit of Measure for Dimensional Coping is Layer. The Unit of Measure for Kodah Wall Standard is Layer while the Kodah Wall Corner is Each.

Rosetta® Outcropping

DESCRIPTION	UNIT					PALLET					PRICE
	SIZE (H X W X D)		FACE AREA		WEIGHT	NO. OF UNITS	NO. OF ROWS	FACE AREA		WEIGHT	
	MM	IN	M2	SQ FT	LB			M2	SQ FT	LB	
Pallet A	305 x 1067 x 610/508	12 x 42 x 24/20				4	-	1.67	18	3865	
	305 x 1219 x 610/508	12 x 48 x 24/20	-	-	-						
	305 x 1524 x 610/508	12 x 60 x 24/20									
	305 x 1676 x 610/508	12 x 66 x 24/20									
Pallet B	152 x 610 x 610/508	6 x 24 x 24/20				6	-	1.67	18	3951	
	152 x 914 x 610/508	6 x 36 x 24/20	-	-	-						
	152 x 1219 x 610/508	6 x 48 x 24/20									
	305 x 914 x 610/508	12 x 36 x 24/20									
	305 x 1372 x 610/508	12 x 54 x 24/20									
	305 x 1829 x 610/508	12 x 72 x 24/20									
Pallet C	152 x 610 x 610/508	6 x 24 x 24/20				4	-	1.67	18	3889	
	152 x 914 x 610/508	6 x 36 x 24/20	-	-	-						
	610 x 1219 x 610/508	24 x 48 x 24/20									
	457 x 1524 x 610/508	18 x 60 x 24/20									
Pallet D Freestanding*	305 x 1524 x 762	12 x 60 x 30				3	-	1.02	11	3150	
	305 x 1219 x 762	12 x 48 x 30	-	-	-						
	152 x 1219 x 762	6 x 48 x 30									
Pallet E Freestanding*	305 x 1829 x 762	12 x 72 x 30				3	-	.98	10.5	3500	
	305 x 914 x 762	12 x 36 x 30	-	-	-						
	152 x 914 x 762	6 x 36 x 30									
Corner	305 x 1219 x 737	12 x 48 x 30	.37	6.5	1204	3	-	1.11	12	3612	
Lifting Device (104063)	-	-	-	-	-	1	-	-	-	53	
Paraweb Rosetta Strapping (104064)	-	-	-	-	-	1	328 lin. ft per roll	-	-	28	

COLOURS	ITEM NO. PALLET A	ITEM NO. PALLET B	ITEM NO. PALLET C	ITEM NO. PALLET D - F/S	ITEM NO. PALLET D - W/ CORE	ITEM NO. PALLET E - F/S	ITEM NO. PALLET E - W/ CORE	ITEM NO. CORNER
Copper Canyon	141445	141449	141453	141457	141461	141465	141469	104004
Fond du Lac	141446	141450	141454	141458	141462	141466	141470	104005
Pacific Grey	141448	141452	141456	141460	141464	141468	141472	104006
Northern Charcoal	141447	141451	141455	141459	141463	141467	141471	138117



Notes: Product is machine installed. Outcropping Pallet D and E are non-stocking. Outcropping Pallet D and E with core are Special Order. It is recommended that multiple bundle orders be ordered in quantities of 2A, 2B, and 1C. Pallet D and E can be ordered separately. *Can be ordered solid or with hollow core. Available to order in full pallets only. A \$35.00 returnable pallet fee will be charged to any bundle of Outcropping. Paraweb strapping sold in full rolls only, at 328 linft per roll. The Unit of Measure for Outcropping (Pallet A, B, C, D, E) is Square Feet. The Unit of Measure for Outcropping Corner is Each.

StackStone®

DESCRIPTION	UNIT					PALLET ROW				PALLET				PRICE
	SIZE (H X W X D)		FACE AREA		WEIGHT	NO. OF UNITS	FACE AREA		NO. OF UNITS	NO. OF ROWS	FACE AREA		WEIGHT	
	MM	IN	M2	SQ FT	LB		M2	SQ FT			M2	SQ FT	LB	
Standard	102 x 203/152 x 203	4 x 8/6 x 8	0.02	0.22	18	24	0.5	5.35	120	5	2.48	26.75	2160	
Coping	102 x 203/152 x 203	4 x 8/6 x 8	0.02	0.22	18	24	0.5	5.35	120	5	2.48	26.75	2160	
Advanced Corner	102 x 280/203 x 203	4 x 11/8 x 8	0.02	0.22	27	12	-	-	48	4	0.99	10.7	1296	

COLOURS	ITEM NO. STANDARD	ITEM NO. COPING	ITEM NO. CORNER
Charcoal	103957	103960	104261
Desert Buff	103969	103972	104265
Sierra Grey	103963	103964	104263



Specs:

StackStone Advanced Corner - 3 horizontal layers per pallet
 StackStone Standard and Coping- 6 horizontal layers per pallet

Notes: To calculate pieces required, multiply the wall length, in feet, by 1.72. This will give you the number of pieces required per layer. Then multiply this by the number of layers to determine total quantity required. Please note that 1.72 is the multiplier used for both the standard and coping units. It's recommended to go a maximum of 2' height. Minimum inside diameter of 42" (23 pieces). A \$35.00 returnable pallet fee will be charged to any bundle of StackStone. The Unit of Measure for StackStone is Each.

Retaining Wall Material Requirements

1) BASE MATERIAL

WALL LENGTH		BASE HEIGHT		BASE WIDTH			MATERIAL REQUIRED	
m	x	m	x	m	÷	1	=	m ³
ft	x	ft	x	ft	÷	27	=	cu yd

2) DRAINAGE MATERIAL

WALL LENGTH		BASE HEIGHT		BASE WIDTH			MATERIAL REQUIRED	
m	x	m	x	1.33	÷	1	=	m ³
ft	x	ft	x	1.33	÷	27	=	cu yd



Bridgewood Steps

DESCRIPTION	UNIT			PALLET		PRICE
	SIZE (L X W X H)		WEIGHT	NO. OF	WEIGHT	
	MM	IN	LB	UNITS	LB	
Bridgewood 48" Steps	1200 x 400 x 140	47.24 x 17.75 x 5.51	385	8	3080	

COLOURS	ITEM NO.
Cedar Brown	116941
Weathered Grey	116940

Notes: Colours for Bridgewood Steps are not exact replications of Bridgewood Slab's Weathered Grey and Cedar Brown. The Unit of measure for Bridgewood Steps is Each



Rosetta® Dimensional Steps

DESCRIPTION	UNIT			PALLET		PRICE
	SIZE (L X W X H)		WEIGHT	NO. OF	WEIGHT	
	MM	IN	LB	UNITS	LB	
3'	914 x 457 x 178	36 x 18 x 7	378	6	2268	
4'	1219 x 457 x 178	48 x 18 x 7	504	6	3024	
6'	1829 x 762 x 178	72 x 30 x 7	1260	2	2520	

COLOURS	ITEM NO. 3'	ITEM NO. 4'	ITEM NO. 6'
Fond du Lac	104032	104031	104033
Copper Canyon	104029	104028	104030
Pacific Grey	104035	104034	104036
Northern Charcoal	138119	138120	138121

Notes: A \$35.00 returnable pallet fee will be charged to any pallet of Dimensional Steps. The Unit of measure for Dimensional Steps is Each.



Rosetta® Irregular Steps

DESCRIPTION	UNIT			PALLET		PRICE
	SIZE (L X W X H)		WEIGHT	NO. OF	WEIGHT	
	MM	IN	LB	UNITS	LB	
A	1372 x 559 x 178	54 x 22 x 7	458	1	2962	
B	1524 x 610 x 178	60 x 24 x 7	600	1		
C	1067 x 432 x 178	42 x 17 x 7	349	1		
D	1219 x 711 x 178	48 x 28 x 7	567	1		
E	1067 x 660 x 178	42 x 26 x 7	476	1		
F	1219 x 610 x 178	48 x 24 x 7	512	1		

COLOURS	ITEM NO.
Copper Canyon	241433
Fond du Lac	241434
Pacific Grey	241436
Northern Charcoal	241435

Notes: A, B, C, D, E and F sold together in full pallets only. A \$35.00 returnable pallet fee will be charged to any pallet of Irregular Steps. The Unit of Measure for Irregular Steps is Pallet.





FINISHING TOUCHES

With all that goes into a landscape project, you want to know that the job was finished properly. Our finishing products will make sure your project stays vibrant today, and for years to follow.

Granite Edger

DESCRIPTION	UNIT					PALLET ROW				PALLET				PRICE
	SIZE (L X W X H)		FACE AREA		WEIGHT	NO. OF UNITS	FACE AREA		NO. OF UNITS	NO. OF ROWS	FACE AREA		WEIGHT	
	MM	IN	M2	SQ FT	LB		M2	SQ FT			M2	SQ FT	LB	
Granite Edger	311 x 102 x 102	12.25 x 4 x 4	-	-	15	48	-	-	192	4	-	-	2880	

COLOURS	ITEM NO.
Charcoal	114430



Notes: A \$35.00 returnable pallet fee will be charged to any bundle of Granite Edger. Unit of measure is Each.

I-Con Edger

DESCRIPTION	UNIT					PALLET ROW				PALLET				PRICE
	SIZE (L X W X H)		FACE AREA		WEIGHT	NO. OF UNITS	FACE AREA		NO. OF UNITS	NO. OF ROWS	FACE AREA		WEIGHT	
	MM	IN	M2	SQ FT	LB		M2	SQ FT			M2	SQ FT	LB	
I-con Edger	314 x 92 x 102	12.375 x 3.625 x 4	-	-	15	48	-	-	192	4	-	-	2880	

COLOURS	ITEM NO.
Charcoal	105171
Desert Buff	105175
Sierra Grey	105174
Graphite (BC only)	143727
Natural (BC only)	105169



Notes: A \$35.00 returnable pallet fee will be charged to any bundle of I-Con Edger. The Unit of measure is Each.

Adhesive

ITEM NO.	DESCRIPTION	UNIT			PRICE
		SIZE	COVERAGE (1/4" BEAD)	WEIGHT	
		ML	FT	LB	
123773	Alliance Gator Block Bond XP Adhesive 10 oz	295	30	-	
123774	Alliance Gator Block Bond XP Adhesive 28 oz	828	85	-	
132982	Stronghold Spray Gun Applicator	-	-	-	
133198	Stronghold Spray Adhesive 24 oz	667	510	-	
133531	Stronghold Gun Cleaner 16 oz	473	-	-	



Edge Restraint

ITEM NO.	DESCRIPTION	UNIT			BUNDLE		PALLET	PRICE
		SIZE (L X W X H)		WEIGHT	NO. OF UNITS	WEIGHT	NO. OF UNITS	
		MM	IN	LB	UNITS	LB	UNITS	
112541	Snapedge	2438 x 73 x 44	96 x 2.875 x 1.75	2	24	-	672	
103165	Spikes (Sold in full boxes only)	254 (length)	10 (length)	0.26	150	39	-	



Notes: Snapedge can be sold by the piece. The 10" landscape spikes we sell are smooth.

Installation Tools

ITEM NO.	DESCRIPTION	UNIT		PRICE
		DIMENSIONS	WEIGHT LB	
103164	Paver Saver Uni Mat	L x W: 762 x 559 mm/30 x 22 in	22	
141479	VPR 450 Paver Roller	Base Plate width 16.5"	238	
139965	VPR 700 Paver Roller	Base Plate width 26"	385	
139936	Quick-E Block Clamp BL 180	Adjusts from 7" to 18"	10	
139943	Quick-E Block Clamp BL 450	Adjusts from 33" to 51"	43	
127440	Quick-E Block Clamp BL 850	Adjusts from 0" to 16 1/2"	53	
139926	Quick-E Screeder Package	3', 4 1/2', and 6'	18	
139948	Quick-E Sand Plow (Handle not included)	-	8	
139927	Quick-E-Slab Small	Adjusts from 10" to 24"	11	
139933	Elite Suction T-Handle plus Venturi Tool	6"x6" & 10"x10" pads	10	
139958	Halder Supercraft Dead Blow Mallet	70mm	4.9	
139957	Halder Simplex Wall Mallet-Medium	60mm	3.3	



Notes: Price fluctuates with US currency valuation, please contact Barkman for a quote.
Many more options available, please call your local barkman representative for more details.

Landscaping Materials

ITEM NO.	DESCRIPTION	UNIT			PRICE
		SIZE (L X W)		WEIGHT	
		MM	IN	LB	
103147	Geo-Textile 6oz Non Woven	91400 x 4572	3600 x 180	220	
133567	Geo Grid 5XT	45720 x 3658	1800 x 144	118	
133673	Geo Grid 10XT	60960 x 3658	2400 x 144	277	
123777	Alliance Gator Base (10 units per package)	902 x 597	35.5 x 23.5	15	
123767	Gator Screws	-	-	-	
123763	Gator Edge Rigid 8ft Length	-	-	-	



Notes: Geo Textile 6oz Non Woven is sold by square footage. Geo Grid products are sold in full rolls only.

Polymeric Sand

ITEM NO.	DESCRIPTION	UNIT	PALLET		PRICE
		WEIGHT LB	NO. OF UNITS	WEIGHT LB	
134875	Alliance Polybind Complete G2 Nevada Tan	50	56	2800	
134876	Alliance Polybind Complete G2 Oxford Grey	50	56	2800	
134879	Alliance Polybind Complete G2 Jet Black	50	56	2800	
134878	Alliance Polybind Complete G2 Ivory White	50	56	2800	



Notes: These numbers on coverage are only approximate due to variability in laying application. No minimum order requirements, can be ordered by bag or by pallet as needed. BC customers must order in full pallets. For coverage calculation, refer to Alliance calculator (www.alliancegator.com/nitro-sand-polymeric-sand-simplified-calculator).

INSTALLATION RECOMMENDATIONS

✓ Yes

✗ No

○ Optional

~ Some sizes in this family meet requirements, call your local Barkman representative for more information.

LAYING PATTERNS	PEDESTRIAN TRAFFIC	VEHICULAR TRAFFIC	EDGE RESTRAINTS	BEDDING SAND (25 MM/1 IN)	SPACERS REQUIRED	JOINT SAND	ALLIANCE POLYBIND COMPLETE G2 SAND	COMPACT AFTER INSTALL	COMPACT WITH SAVER MAT	COMPACT WITH ROLLER COMPACTOR
-----------------	--------------------	-------------------	-----------------	---------------------------	------------------	------------	------------------------------------	-----------------------	------------------------	-------------------------------

SLABS										
Arborwood	3	✓	✗	○	✓	✓	✓	○	✗	✓
Bridgewood	1	✓	✗	○	✓	✓	○	○	✗	✓
Brookside	4	✓	✗	○	✓	✓	○	○	✗	✓
Diamond Face	-	✓	✗	○	✓	✓	✗	✗	✗	✓
Footing Pads	-	✓	✗	○	✓	✗	✗	✗	✗	✓
Lexington	4	✓	✗	○	✓	✓	○	○	✗	✓
Rosetta® Dimensional Flagstone	2	✓	✗	○	✓	○	✓	○	✗	✓
Rosetta® Grand Flagstone	1	✓	✗	○	✓	○	✓	○	✗	✓
Stepping Stone – Broadway 300 x 300 x 65mm	-	✓	✗	○	✓	✗	✗	✗	✗	✓
Terrace NEW BC-EXCLUSIVE	2	✓	✗	✗	✗	✗	✗	✗	✗	✗

PAVERS (60 MM/2.36 IN)										
Broadway 65mm	9	✓	✗	✓	✓	✗	✓	○	✓	✓
Fjord	6	✓	✗	✓	✓	✗	✓	○	✓	✓
Flagstone	1	✓	✗	✓	✓	✓	✗	✓	✓	✓
Hexagon 65mm NEW	1	✓	✓	✓	✓	✗	✓	○	✓	✓
Holland	6	✓	✓	✓	✓	✗	✓	○	✓	○
Roman	3	✓	✓	✓	✓	✓	✓	○	✓	✗
Roman Circle	1	✓	✓	✓	✓	✓	✓	○	✓	✗
Verano	2	✓	✓	✓	✓	✗	✓	○	✓	○

PAVERS (80 MM/3.15 IN)										
Boardwalk (Special Order)	1	✓	✓	✓	✓	✗	✓	○	✓	✓
Cobble	1	✓	✓	✓	✓	✗	✓	○	✓	✓
Holland 80mm	5	✓	✓	✓	✓	✗	✓	○	✓	○
Mesa Flagstone	1	✓	✓	✓	✓	✗	✗	✓	✓	✓
Navarro	1	✓	✓	✓	✓	✗	✓	○	✓	✓

PAVERS (100 MM/3.94 IN)										
Broadway 100mm & Broadway Planks	12	✓	~	✓	✓	✗	✓	✓	✓	~
Broadway Contour 100mm NEW	12	✓	~	✓	✓	✗	✓	✓	✓	~

Note: Alliance Polybind Complete G2 sand recommended for commercial/high traffic areas. Indications on Terrace refer to rooftop applications.

	NATURAL	CHARCOAL	ANTIQU BROWN	SIERRA GREY	DESERT BUFF	GLACIER	BEDROCK	STERLING	CEDAR BROWN	WEATHERED GREY	FOND DU LAC	COPPER CANYON	NORTHERN CHARCOAL	PACIFIC GREY	HAZEL	FLINT	SANDSTONE	KODIAK BROWN	TIMBER WOLF GREY	QUARTZ	ASH	AMBER	GRAPHITE (BC only)	
PAVERS																								
Boardwalk																								Special Order Colours
Broadway 65mm	●	●		●				●									●				●	●	●	●
Broadway 100mm	●	●						●													●	●	●	
Broadway Contour 100mm																								Special Order Colours
Bullnose		●																						
Cobble		●																						
Colonial Eco																								Special Order Colours
Fjord							●	●																
Flagstone			●	●																				
Granite Edger		●																						
Hexagon 65mm	●	●																				●		
Holland	●	●	●	●																				●
Holland 80mm		●																						
Holland Eco																								Special Order Colours
I-con Edger		●		●	●																			
Mesa Flagstone				●				●																
Navarro		●		●																				
Roman		●	●	●	●																			●
Roman Bullnose		●																						
Roman Circle		●	●	●																				●
Turfstone Eco	●																							
Verano		●		●																				
SLABS																								
Arborwood																								● ●
Bridgewood									●	●														
Brookside		●		●												●								
Diamond Face	●																							
Lexington								●									●	●						
Rosetta® Dimensional Flagstone											●	●	●	●										
Rosetta® Grand Flagstone											●	●	●	●										
Stepping Stone - Broadway 300 x 300 x 65mm	●	●		●				●									●				●	●	●	●
Terrace (BC only)	●	●																						●

Note: Sierra Grey for Broadway 65mm and Stepping Stone is BC only.

	NATURAL	CHARCOAL	SIERRA GREY	DESERT BUFF	GREY	STERLING	FOND DU LAC	COPPER CANYON	NORTHERN CHARCOAL	PACIFIC GREY	FLINT	ASH	CEDAR BROWN	WEATHERED GREY	GRAPHITE (BC only)
WALLS															
Architextures						●					●	●			
Architextures Atlas						●									
Bridgewood Wall													●	●	
Keystone Compac III – Hewnstone	●	●	●												●
MagnumStone™	●														
Quarry Stone		●	●												
RomanStack®		●	●	●											
Rosetta® Belvedere							●	●	●	●					
Rosetta® Dimensional Wall							●	●	●	●					
Rosetta® Kodah							●	●	●	●					
Rosetta® Outcropping							●	●	●	●					
Smooth Quarry Stone		●													
Splitface Coping		●	●												
StackStone®		●	●	●											

It's What's Underneath That Counts



Compacted Native Soil Subgrade

Preparation of the native soil subgrade is critical to the performance of an interlocking concrete pavement. Large rocks, roots, organic material and all other debris should be removed from the native soil subgrade and in turn be replaced with the crushed aggregate material that will be used to construct the compacted aggregate base. From there, the soil subgrade should be compacted to a minimum 98% standard Proctor density, with modified Proctor density being the preferred standard to use for vehicular applications. The overall success of an interlocking concrete pavement begins with a native soil subgrade that has been prepared and compacted as per the standards and guidelines set out by the Interlocking Concrete Pavement Institute.

Compacted Aggregate Base Layer

The functionality, lifespan and success of an interlocking concrete pavement application is directly related to the compacted aggregate base installed beneath it. Each unique project requires that a proper base design and materials be determined based upon several different variables. Contact your local Barkman representative for more information.

Screeded Bedding Layer

Like the compacted aggregate base, the screeded bedding layer plays a vital role in the overall performance of an interlocking concrete pavement application. The Interlocking Concrete Pavement Institute states that precast concrete pavers should be installed on top of an uncompacted 25 mm layer of concrete sand (CSA A23.1). For more information on what your commercial project will require, you can get in touch with your local Barkman representative.

The ICPI technical specifications are also great resources for application information. (www.icpi.org)



LANDSCAPE KITS

Landscape kits offer a cost effective way to turn any backyard into something special without custom concrete work. In an afternoon or less, you could build a complete kit from our collection of bars, fire pits and our Quarry Stone Outdoor Kitchens. Modular in design and timeless in their appeal, Barkman kits offer the easy choice to elevate your backyard ambitions.

Quarry Stone Fireplaces

KIT	SPECIFICATIONS		NO. OF SKIDS	PALLETS						INCLUDES	PRICE
	ASSEMBLED SIZE (H X W X D)			WEIGHT (LB)							
	MM	IN		1	2	3	4	TOTAL	CHARGED		
Quarry Stone Fireplace	2699 x 1397 x 1156	106.25 x 55 x 45.5	4	3064	2998	1320	683	8065	3	Quarry Stone, Charcoal accents, fire brick, arch, mantle, recess panel, roof, fire brick, fireplace caps, raincap, plastic and steel shims, adhesive, gloves, instructions	
Raincap	257 x 476 x 686	10.13 x 18.75 x 27	1	10				10	-	Raincap	
Quarry Stone Fireplace Wood Storage	889 x 1061 x 914	35 x 40 x 36	1	2359				2359	2	Quarry Stone, countertop, shims, adhesive, gloves, instructions	
Quarry Stone Compact Fireplace	1981 x 1118 x 1016	78 x 44 x 40	3	3036	2176	594		5806	3	Quarry Stone, fire brick, hearth, cap, mantle, spark arrestor, shims, high heat sealant, adhesive, instructions, gloves	
Quarry Stone Compact Fireplace Wood Storage	965.2 x 813 x 711	38 x 32 x 28	1	2047	2176	594		2047	2	Quarry Stone, countertop, shims, adhesive, gloves, instructions	

COLOURS	ITEM NO. FIREPLACE	ITEM NO. WOOD STORAGE	ITEM NO. COMPACT FIREPLACE	ITEM NO. COMPACT FIREPLACE WOOD STORAGE	RAINCAP
Sierra Grey/ Charcoal Accent	134517	113461	119339	120519	134752

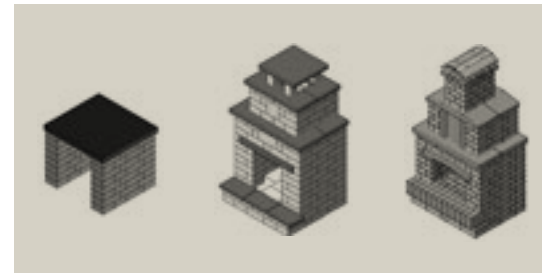

Notes: These kits were formerly named Stone Oasis Fireplace and Stone Oasis Compact Fireplace. Colours may vary between various components. For detailed video installation, please visit BarkmanConcrete.com

Architextures Fire Pit

KIT	SPECIFICATIONS		PALLET		INCLUDES	PRICE
	ASSEMBLED SIZE (H X W X D)		NO. OF PALLETS	WEIGHT LB		
	MM	IN				
Architextures Wall Fire Pit	400 x 1184 x 1184 (outside)	15.75 x 47 x 47 (outside)	1	2069.68	Architextures Wall Corners, Coping, 30" Fire pit liner, 23" Spark Arrestor	
	400 x 614 x 614 (inside)	15.75 x 24 x 24 (inside)				
Fire Pit Liner (141369)	409.7 x 762 x 762	16.13 x 30 x 30				
Spark Arrestor (134499)	584.2 x 584.2	23 x 23				

COLOURS	ITEM NO.
Ash	123824
Sterling	123839
Flint	123842

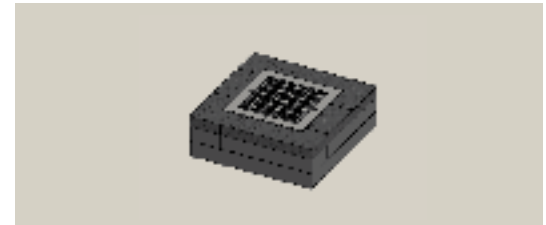

Notes: The Architextures Fire Pit has 2 layers with 4 pcs per layer and 8 pcs of coping layer. Inside dimensions of steel liner are 24.19" or 615mm. The consumer is responsible for reviewing the local regulations, by-laws, building codes, insurance implications any above ground and underground services pertaining to product installation and use. Fire pit fire size should not allow flame to contact the top layers. Fire pits should not be placed directly on concrete products as high heat can adversely affect the product integrity.

Bridgewood Fire Pit

KIT	SPECIFICATIONS		PALLET		INCLUDES	PRICE
	ASSEMBLED SIZE (H X W X D)		NO. OF PALLETS	WEIGHT LB		
	MM	IN				
Bridgewood Wall Fire Pit	305 x 1270 x 1270 (outside)	12 x 50 x 50 (outside)	1	1491.44	Bridgewood Wall, gloves, instructions, 37" Steel liner, 29" spark arrestor	
	305 x 864 x 864 (inside)	12 x 34 x 34 (inside)				
Fire Pit Liner (134764)	318 x 940 x 940	12.5 x 37 x 37				
Spark Arrestor (134783)	737 x 737	29 x 29				

COLOURS	ITEM NO.
Cedar Brown	141047
Weathered Grey	141048

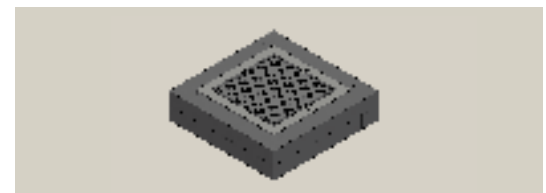

Notes: The Bridgewood Wall Fire Pit has 2 layers with 4 pcs per layer. Inside dimensions of steel liner are 34" or 864mm. The consumer is responsible for reviewing the local regulations, by-laws, building codes, insurance implications any above ground and underground services pertaining to product installation and use. Fire pit fire size should not allow flame to contact the top layers. Fire pits should not be placed directly on concrete products as high heat can adversely affect the product integrity.

Quarry Stone Fire Pit

KIT	SPECIFICATIONS		PALLET		INCLUDES	PRICE
	ASSEMBLED SIZE (H X W X D)		NO. OF PALLET	WEIGHT LB		
	MM	IN				
Square Complete	305 x 1118 x 1118 (outside)	12 x 44 x 44 (outside)	1	1190	Quarry Stone, gloves, 27" spark arrestor	
	305 x 711 x 711 (inside)	12 x 28 x 28 (inside)				
Square Spark Arrestor (113807)	686 x 686	27 x 27	-	5		
Fire Pit Liner* (115253)	711 x 711	28 x 28	1	55		

COLOURS	ITEM NO.
Charcoal	113806
Sierra Grey	115753

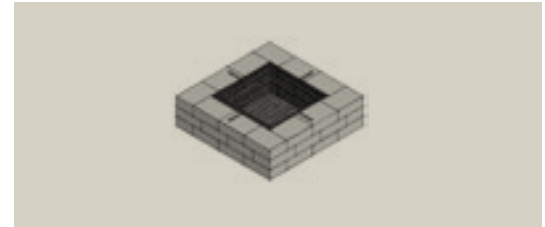

Notes: The Quarry Stone Fire pit, formerly the Stone Oasis Square Fire Pit has 3 layers with 12 pieces per layer. *Fire Pit liner sold separately. The consumer is responsible for reviewing the local regulations, by-laws, building codes, insurance implications any above ground and underground services pertaining to product installation and use. Fire pit fire size should not allow flame to contact the top layers. Fire pits should not be placed directly on concrete products as high heat can adversely affect the product integrity.

Smooth Quarry Stone Fire Pit

KIT	SPECIFICATIONS		PALLET		INCLUDES	PRICE
	ASSEMBLED SIZE (H X W X D)		NO. OF PALLET	WEIGHT LB		
	MM	IN				
Square Complete	305 x 1118 x 1118 (outside)	12 x 44 x 44 (outside)	1	1217	Smooth Quarry Stone, gloves, 27" spark arrestor, Fire Pit liner	
	305 x 711 x 711 (inside)	12 x 28 x 28 (inside)				
Square Spark Arrestor (113807)	686 x 686	27 x 27	-	5		
Fire Pit Liner (115253)	711 x 711	28 x 28	1	55		

COLOURS	ITEM NO.
Charcoal	134379
Sierra Grey	137931

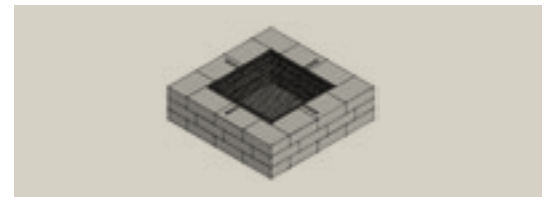

Notes: The Smooth Quarry Stone Fire pit, formerly the Modern Fire Pit has 3 layers with 12 pieces per layer. The consumer is responsible for reviewing the local regulations, by-laws, building codes, insurance implications any above ground and underground services pertaining to product installation and use. Fire pit fire size should not allow flame to contact the top layers. Fire pits should not be placed directly on concrete products as high heat can adversely affect the product integrity.

Rosetta® Belvedere Fire Pit

KIT	SPECIFICATIONS		PALLETS		INCLUDES	PRICE
	ASSEMBLED SIZE (H X D)		NO. OF PALLETS	WEIGHT LB		
	MM	IN				
Belvedere Fire Pit	368.3 x (+/-73.2) (outside) 381 x 940 (inside)	14.5 x (+/- 58) (outside) 15 x 37 (inside)	1	1257	Belvedere, gloves, black steel ring	
Circle Spark Arrestor* (114836)	- x 940	- x 37	-	12		
Circle Black Steel Ring (103593)	305 x 965	12 x 38	1	45		

COLOURS	ITEM NO.
Fond du Lac	103507
Copper Canyon	103511
Pacific Grey	103508
Northern Charcoal	138122



Notes: 37" diameter spark arrestor sold separately. Caps don't contact lip of steel ring. For detailed video installation, please visit BarkmanConcrete.com. The consumer is responsible for reviewing the local regulations, by-laws, building codes, insurance implications any above ground and underground services pertaining to product installation and use. Fire pit fire size should not allow flame to contact the top layers. Fire pits should not be placed directly on concrete products as high heat can adversely affect the product integrity.

Rosetta® Dimensional Fire Pit

KIT	SPECIFICATIONS		PALLETS		INCLUDES	PRICE
	ASSEMBLED SIZE (H X W X D)		NO. OF PALLETS	WEIGHT LB		
	MM	IN				
Dimensional Fire Pit	305 x 1118 x 1118 (outside) 305 x 711 x 711 (inside)	12 x 44 x 44 (outside) 12 x 28 x 28 (inside)	1	1170	Dimensional Wall, 27" spark arrestor, liner, gloves	
Square Spark Arrestor (113807)	675 x 675	27 x 27	-	5		
Square Fire Pit Liner (115253)	711 x 711	28 x 28	1	55		

COLOURS	ITEM NO.
Fond du Lac	115347
Copper Canyon	115346
Pacific Grey	115348
Northern Charcoal	138123

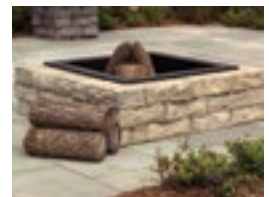

Notes: The consumer is responsible for reviewing the local regulations, by-laws, building codes, insurance implications any above ground and underground services pertaining to product installation and use. Fire pit fire size should not allow flame to contact the top layers. Fire pits should not be placed directly on concrete products as high heat can adversely affect the product integrity.

StackStone Fire Pit

KIT	SPECIFICATIONS		PALLETES		INCLUDES	PRICE
	ASSEMBLED SIZE (H X D)		NO. OF PALLETES	WEIGHT LB		
	MM	IN				
Circle Complete	305 x 1067 (outside) 305 x 635 (inside)	12 x 42 (outside) 12 x 25 (inside)	1	838	StackStone®, gloves, 24" spark arrestor, instructions	
Circle Spark Arrestor (112548)	- x 610	- x 24		5		

COLOURS	ITEM NO.
Charcoal	103520
Desert Buff	103519
Sierra Grey	103522

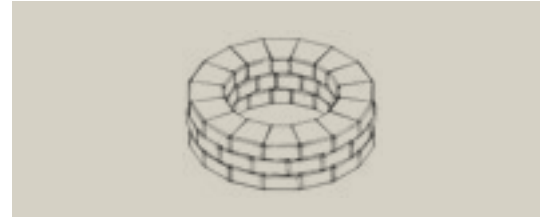

Notes: The StackStone Fire pit, formerly the Stone Oasis Circle Fire Pit has three layers with 16 pieces per layer. For detailed video installation, please visit BarkmanConcrete.com. The consumer is responsible for reviewing the local regulations, by-laws, building codes, insurance implications any above ground and underground services pertaining to product installation and use. Fire pit fire size should not allow flame to contact the top layers. Fire pits should not be placed directly on concrete products as high heat can adversely affect the product integrity.

StackStone Fire Pit Accessories **NEW**

KIT	SPECIFICATIONS		PALLETES		INCLUDES	PRICE
	ASSEMBLED SIZE (H X D)		NO. OF PALLETES	WEIGHT LB		
	MM	IN				
Coping	51 x 1118 (outside) 51 x 635 (inside)	2 x 44 (outside) 2 x 25 (inside)	1	171.54	6 coping units	
Liner	356mm x 762mm	14 x 30	1	48		

COLOURS	ITEM NO.
Natural & Charcoal Coping	
Stackstone Firepit Coping Kit – Charcoal	143518
Stackstone Firepit Coping Kit - Natural	143308
Steel Ring Liner	
Stackstone Firepit Liner Kit	143309

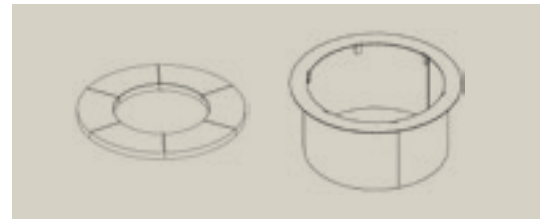

Notes: The StackStone Fire Pit is sold separately. The Coping for the fire pit is sold separately and can be purchased as a set of 6 pieces. The liner is sold separately. Liner only fits in the fire pit unit with the coping around it. Without the coping, the liner will be too high for the fire pit.

Barkman Outdoor Kitchen Kits

KIT	ITEM NO.	SPECIFICATIONS		NO. OF SKIDS	PALLETS						INCLUDES	PRICE
		ASSEMBLED SIZE (H X W X D) BASE (L X D)			WEIGHT (LB)							
		MM	IN		1	2	3	4	TOTAL	PALLETS CHARGED		
Quarry Stone Bar Counter	141078	953 x 1226 x 787 1219 x 711	37.5 x 48.25 x 31 48 x 28	1	3049.04	-	-	-	3049.04	2	Quarry Stone, Polished Granular Finish Countertop, Gloves, Shims, Adhesive	
Quarry Stone Extended Bar Counter	141270	953 x 1226 x 1041 1219 x 711	37.5 x 48.25 x 41 48 x 28	1	3109.35	-	-	-	3109.35	2	Quarry Stone, Polished Granular Finish Countertop, Gloves, Shims, Adhesive	
Compact Pizza Oven Unit	135882	1016 x 762 x 749 814 x 711	40 x 30 x 29.5 32 x 28	1	115	-	-	-	115	1	Pizza Oven unit, pizza peel	
Quarry Stone Corner Unit	141079	953 x 953 x 953 914 x 914	37.5 x 37.5 x 37.5 36 x 36	1	2936.73	-	-	-	2936.73	2	Quarry Stone, Polished Granular Finish Countertop, Gloves, Shims, Adhesive	
Quarry Stone LH Extended Corner Unit	141271	953 x 1207 x 953 914 x 914	37.5 x 47.5 x 37.5 36 x 36	1	2983.56	-	-	-	2983.56	3	Quarry Stone, Polished Granular Finish Countertop, Gloves, Shims, Adhesive	
Quarry Stone RH Extended Corner Unit	141272	953 x 1207 x 953 914 x 914	37.5 x 47.5 x 37.5 36 x 36	1	2983.56	-	-	-	2983.56	3	Quarry Stone, Polished Granular Finish Countertop, Gloves, Shims, Adhesive	
Quarry Stone End Unit	141080	953 x 749 x 787, 711 x 711	37.5 x 29.5 x 31, 28 x 28	1	2022.2	-	-	-	2022.2	2	Quarry Stone, Polished Granular Finish Countertop, Gloves, Shims, Adhesive	
Quarry Stone Extended End Unit	141273	953 x 749 x 1041, 711 x 711	37.5 x 29.5 x 41, 28 x 28	1	1974.98	-	-	-	1974.98	2	Quarry Stone, Polished Granular Finish Countertop, Gloves, Shims, Adhesive	
Quarry Stone Fridge Surround	141077	953 x 1226 x 787 1219 x 711	37.5 x 48.25 x 31 48 x 28	1	2473.42	-	-	-	2473.42	2	Quarry Stone, Polished Granular Finish Countertop, Gloves, Shims, Adhesive	
Quarry Stone Extended Fridge Surround	141269	953 x 1226 x 1041 1219 x 711	37.5 x 48.25 x 41 48 x 28	1	2533.74	-	-	-	2533.74	2	Quarry Stone, Polished Granular Finish Countertop, Gloves, Shims, Adhesive	
Quarry Stone Grill Base	141073	953 x 1630 x 787	37.5 x 64.19 x 31	1	3260.65	-	-	-	3260.65	2	Quarry Stone, Door Frame, Set of Doors, Polished Granular Finish Countertop, Gloves, Shims	
Quarry Stone Grill Surround	141075	953 x 611 x 787 610 x 711	37.5 x 24.06 x 31 24 x 28	1	1758.86	-	-	-	1758.86	2	Quarry Stone, Polished Granular Finish Countertop, Gloves, Shims, Adhesive	



KIT	ITEM NO.	SPECIFICATIONS		NO. OF SKIDS	PALLET						INCLUDES	PRICE	
		ASSEMBLED SIZE (H X W X D) BASE (L X D)			WEIGHT (LB)								
		MM	IN		1	2	3	4	TOTAL	PALLETS CHARGED			
Quarry Stone Rocket Stove	141076	953 x 510 x 851 508 x 711	37.5 x 20.06 x 33.5 20 x 28	1	1681	-	-	-	-	1681	2	Quarry Stone, Polished Granular Finish Countertop, Stainless Steel Trim, Rocket Stove Assemble, Stainless Steel Cooking Element, Adhesive, Gloves, Shims.	
Quarry Stone Storage Unit	141081	953 x 814 x 787 813 x 711	37.5 x 32.09 x 31 32 x 28	1	1947	-	-	-	-	1947	2	Quarry Stone, Polished Granular Finish Countertop, shims, adhesive, gloves, instructions	
Quarry Stone Extended Storage Unit	141274	953 x 814 x 1041 813 x 711	37.5 x 32.06 x 41 32 x 28	1	1987	-	-	-	-	1987	2	Quarry Stone, Polished Granular Finish Countertop, Gloves, Shims, Adhesive	
Quarry Stone Wood Grill	141074	953 x 1630 x 787 1626 x 711	37.5 x 64.19 x 31 64 x 28	1	4206	-	-	-	-	4206	3	Quarry Stone, Door Frame, Polished Granular Finish Countertop, Firebrick, Stainless Steel Spark Arrestor, Stainless Steel Food Grill, Adhesive, Gloves, Shims	

COLOURS

Sierra Grey/Charcoal Accent

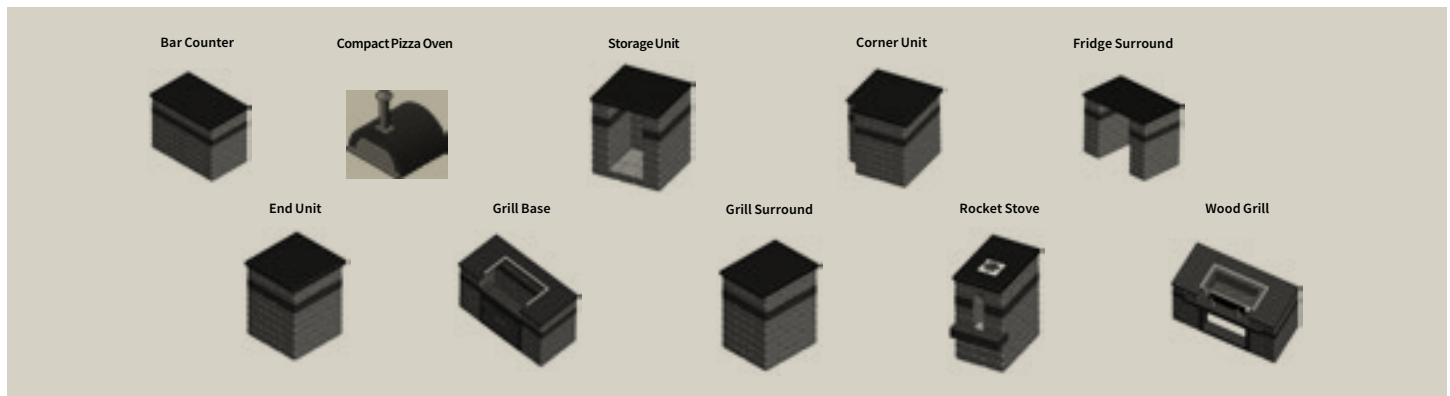

Notes: Quarry Stone Outdoor Kitchen Kits come with Polished Granular Finish Countertop which have an exposed aggregate and smooth finish. Colours may vary between various components. When ordering the Extended Countertop, determine Left or Right unit by imagining standing behind the bar counter looking out towards the extended countertop section. Example: looking to the right side would entail ordering a right unit Extended Countertop. The Quarry Stone Compact Pizza Oven kit is made up of the Pizza Oven unit (Nonno Peppe) and the Quarry Stone Storage Unit that acts as a wood storage. These components are purchased separately. Outdoor kitchen kits produced prior to 2020 contain a wetcast band, which makes these kits 1" shorter than our current ones. These kits won't line up with our latest Quarry Stone Outdoor due to the height difference.

Barkman Outdoor Kitchen Kit Components

KIT COMPONENTS	ITEM NO.	SPECIFICATIONS		PALLET		INCLUDES	PRICE
		ASSEMBLED SIZE (L X W X H)		NO. OF PALLETS	LBS		
		MM	IN				
Bar & Fridge Countertop	141065	-	48.25 x 31 x 1.5	1	187	Polished Granular Finish Countertop	
Bar and Fridge Extended Countertop	141066	-	48.25 x 41 x 1.5	1	247	Polished Granular Finish Countertop	
Corner Unit Countertop	141069	-	37.5 x 37.5 x 1.5	1	171	Polished Granular Finish Countertop	
Corner Unit Extended LH Countertop	141017	-	47.5 x 37.5 x 1.5	1	217	Polished Granular Finish Countertop	
Corner Extended RH Countertop	141016	-	47.5 x 37.5 x 1.5	1	217	Polished Granular Finish Countertop	
Compact Storage Countertop	141067	-	32 x 31 x 1.5	1	124	Polished Granular Finish Countertop	
End Unit Countertop	141071	-	29.5 x 31 x 1.5	1	114	Polished Granular Finish Countertop	
End Unit Extended Countertop	141072	-	29.5 x 41 x 1.5	1	151	Polished Granular Finish Countertop	
Grill Base Door Assembly	141003	-	32 x 6.5 x 24	1	139	Frame, Hinges (4), Doors (2), Pulls (2)	
Grill Surround Countertop	141063	-	24 x 31 x 1.5	1	94	Polished Granular Finish Countertop	
Storage Unit Extended Countertop	141068	-	32 x 41 x 1.5	1	165	Polished Granular Finish Countertop	
Rocket Stove Assembly	140286	-	12.13 x 4.75 x 22.25	1	23	Heat Assembly	
Rocket Stove Cooking Element	140284	-	7 x 7 x 1.25	1	1	Stainless Steel Cooking Element	
Rocket Stove Countertop	141064	-	20 x 31 x 1.5	1	76	Polished Granular Finish Countertop	
Rocket Stove Trim	140292	-	8 x 8 x .13	1	2	Stainless Steel Trim	
Countertop Trim	141001	-	34.5 x 18 x 1.5	1	3	Stainless Steel Trim	
Grill Back Countertop	141062	-	32 x 9.5 x 1.5	1	38	Polished Granular Finish Countertop	
Grill Base Door Frame	141012	-	32 x 6.5 x 24	1	138	GFRC door frame	
Grill Side Countertop	141061	-	16 x 31 x 1.5	1	63	Polished Granular Finish Countertop	
Stainless Steel Food Grill	141008	-	31 x 15 x .75	1	4	Stainless Steel Food Grill	
Wood Grill Bridge	141010	-	40 x 13.5 x 8	1	214	-	
Wood Grill Spark Arrestor	141009	-	23 x 4.5 x 8.125	1	5	Stainless Steel Spark Arrestor	

Notes: Polished Granular Finish Countertop have an exposed aggregate and smooth finish. Colours may vary between various components. When ordering the Extended Countertop, determine Left or Right unit by imagining standing behind the bar counter looking out towards the extended countertop section. Example: looking to the right side would entail ordering a right unit Extended Countertop.

Barrier Curbs

ITEM NO.	DESCRIPTION	UNIT			PALLET		PRICE
		SIZE (L X W AT BASE X H)		WEIGHT	NO. OF	WEIGHT	
		MM	IN	LB	UNITS	LB	
106470	120" x 26"	3048 x 425 x 660	120 x 16.75 x 26	1570	-	-	
106484*	120" x 30"	3048 x 425 x 762	120 x 16.75 x 30	2225	-	-	
106489	60" x 26"	1524 x 425 x 660	60 x 16.75 x 26	775	-	-	
106488*	60" x 30"	1524 x 425 x 762	60 x 16.75 x 30	1115	-	-	

Notes: *30" high Barrier Curbs have forklift pockets. No pallet required. All 10' Barrier Curbs have 3/4" Threaded insert for lifting.

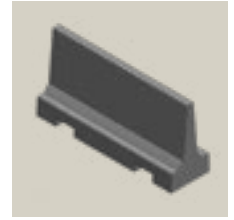

Highway Barrier Curbs

ITEM NO.	DESCRIPTION	UNIT			PALLET		PRICE
		SIZE (L X W X H)		WEIGHT	NO. OF	WEIGHT	
		MM	IN	LB	UNITS	LB	
106480	60"	1524 x 572 x 851	60 x 22.5 x 33.5	2150	-	-	
106476	120"	3048 x 572 x 851	120 x 22.5 x 33.5	4300	-	-	

Notes: Lifting eyes sold separately. Highway barrier curbs have forklift pockets. 10' Barrier Curbs have 3/4" threaded insert for lifting.

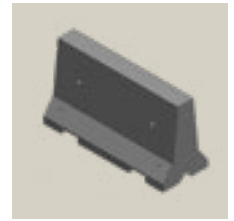

Curbs

ITEM NO.	DESCRIPTION	UNIT			PALLET		PRICE
		SIZE (L X W X H)		WEIGHT	NO. OF	WEIGHT	
		MM	IN	LB	UNITS	LB	
105179	Parking	2438 x 203 x 140	96 x 8 x 5.5	340	10	3400	

Notes: Parking Curb includes 2 pins (15mm x 432mm). Sold by the piece.



Boat Ramp Pads

ITEM NO.	DESCRIPTION	UNIT			PRICE
		SIZE (L X W X H)		WEIGHT	
		MM	IN	LB	
105669	10'/120"	3048 x 356 x 102	120 x 14 x 4	565	
105673	12'/144"	3658 x 432 x 127	144 x 17 x 5	1011	

Notes: 12' Boat Ramp Pad coverage is 17" per Boat Ramp Pad. Detailed specifications available. 1/2" cable not supplied. 20 mm pipe sleeve not supplied. 10' Boat Ramp Pad includes bolting tabs. 5/8" x 3/4" bolts are included.

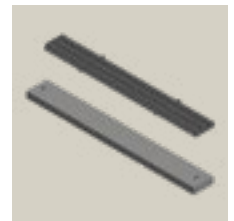

Splash Pads

ITEM NO.	DESCRIPTION	UNIT			PALLET		PRICE
		SIZE (L X W X H)		WEIGHT	NO. OF	WEIGHT	
		MM	IN	LB	UNITS	LB	
141474	30" Natural	762 x 305 x 80	30 x 12 x 3.13	78	28	2184	

Notes: 30" Splash Pads sold in full bundles only.



Returnable Pallet

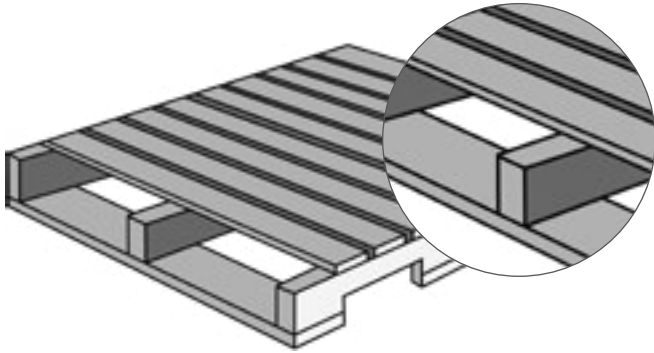

✓ Missing board, but stringers are still intact.

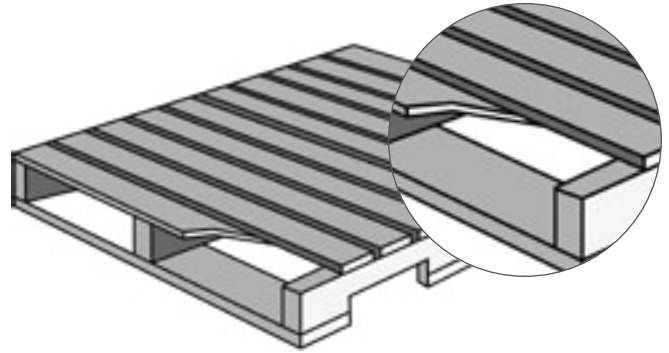

✓ Broken board, but stringers are intact.

Unreturnable Pallet

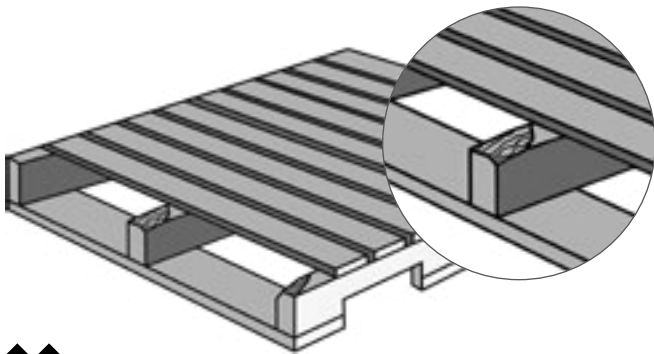

✗ Stringers have broken ends.

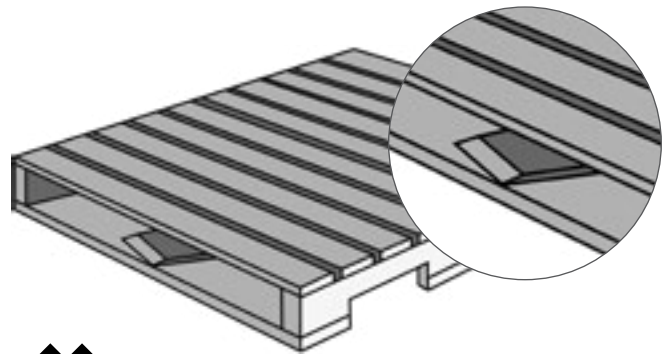

✗ Stringer is broken.

Notes: Only pallets with “Barkman” painted on the side will be received by Barkman. Other brand pallets or pallets without the “Barkman” paint will not be received and no credit will be issued. Barkman will only charge for pallets with the “Barkman” name on the side. Barkman will receive and credit in full returnable Barkman pallets that are in acceptable condition. Barkman works diligently to ensure no broken pallets leave our yard to your location. Should an “unacceptable” pallet be brought to your yard by delivery, please document it before being unloaded and inform Barkman immediately. This will ensure Barkman does not improperly invoice you for faulty product. Contact your nearest drop off yard before drop off to ensure the best possible service.

The Environment

At Barkman we are committed to being good stewards of the planet. Not only are our products excellent choices for people concerned about the environment, we employ environmental best practices throughout our manufacturing and operations whenever possible.

Barkman Warranty

Barkman Concrete warrants the structural integrity of our paving stone, slabs and retaining wall units. For homeowners, we offer a transferable lifetime warranty, where we will replace or repair at our option, without charge any defective product installed and maintained to our guidelines under normal use. Commercial uses have specific warranties as well.

For more information on this and our warranty policy on other product lines, please go to our website at www.barkmanconcrete.com/about/warranty.

Quality and Support Pledge

All Barkman products are guaranteed to meet or exceed the Canadian Standards Association (CSA) standards. We use only superior grade materials and employ stringent quality control measures throughout the manufacturing process to ensure a quality product every time. We also support our products with one of the industry's largest network of dealers and contractors. When you need us, we'll be there to help.

Important: **Actual colours may vary per region and production facility.** Every effort has been made to ensure accuracy in the colour representations found in our product catalogues. However, due to the natural characteristics of concrete, the manufacturing process and print reproduction, actual colours in the final product may vary from that shown.

How to Order

Ordering Barkman products is as simple as calling or visiting one of our many dealers or contractors. For our convenient dealer locator please visit our website BarkmanConcrete.com/find-a-dealer. Kindly be ready to specify product style and colour choice if required.

If working directly with a contractor, please be sure to specify Barkman products to ensure Barkman quality.

Installation and Project Estimation Support

Barkman provides easy-to-read installation guides that contain simple step-by-step instructions to help make installation a snap. Visit BarkmanConcrete.com/Resources to download a copy. Our website and Barkman App also features a handy product calculator that allows you to easily calculate the quantity of Barkman material and accessories.

Colour Blend Information

Pavers, Slabs and Walls

- Amber:** White with Amber Speckles
- Antique Brown:** Brown (Reddish), Buff, Charcoal
- Ash:** Natural, Grey
- Charcoal:** Charcoal
- Cedar Brown:** Various shades of Brown
- Desert Buff:** Various Shades of Buff
- Flint:** Charcoal, White, Gold Fleck
- Hazel:** Tan, Brown, Buff
- Kodiak Brown:** Light and Dark Brown
- Natural:** Natural Grey
- Quartz:** White with Black Speckles
- Sandstone:** Various shades of Brown and Buff, with White
- Sierra Grey:** Buff, Charcoal
- Sterling:** White, Charcoal, Greys
- Timber Wolf Grey:** Light and Dark Grey
- Weathered Grey:** Various shades of Grey
- Glacier:** Light Grey with Dark Grey blends
- Bedrock:** Dark Grey with Charcoal blends
- Graphite -** Charcoal and Natural blend
- Rosetta®**
- Copper Canyon:** Dark Brown, Charcoal
- Fond du Lac:** Buff, Light Brown, Charcoal
- Pacific Grey:** Light Grey, Charcoal
- Northern Charcoal:** Charcoal

Product Changes for 2023

NEW PRODUCTS

- Hexagon 65mm – Natural, Ash, Charcoal
- StackStone Fire Pit with Coping and Liner
- Broadway Contour 100mm (Special Order Only)
- Terrace Slab (BC only)
- Graphite colour (BC only)

DISCONTINUED PRODUCTS

Walls

- Durahold
- Durahold2
- Pisa2

Finishing Touches

- Pillar Caps

Landscape Kits

- Quarry Stone Curved Bar
- Quarry Stone Pillar
- Belvedere Pillar
- Dimensional Pillar

Specialty Products

- Event Barrier
- Landscape Curbs
- Truck Curbs
- Bicycle Stands
- Pool Heater Pad
- Rain Drain
- 51" Natural Splash Pad
- 96" Natural Splash Pad

All Site Furnishings are discontinued

All Septic Tanks, Well Cribbing and Sump Pump Pits are discontinued

Barkman does its best to ensure accuracy for all measurements of our paving stone. Measurements provided may vary slightly depending on laying application. Best practice is to always have physical product on site before pouring preset structures.

COLOURS

For installation ideas
see the *Barkman
Spaces* catalogue or
BarkmanConcrete.com

Broadway 65mm Paver (page 12)

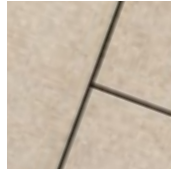

Amber



Ash



Charcoal

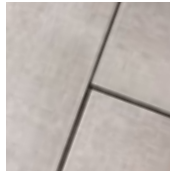

Natural



Quartz



Sandstone



Sterling

BC-EXCLUSIVE COLOURS (NEW)



Graphite



Sierra Grey

Broadway 100mm Paver (page 21)



Amber



Ash



Charcoal

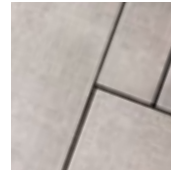

Natural



Quartz



Sterling

Broadway Planks 100mm Paver (page 21)



Amber



Ash



Charcoal

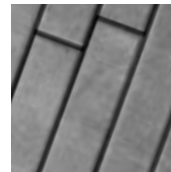

Natural

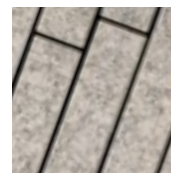

Quartz

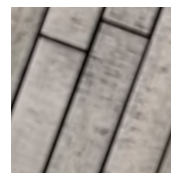

Sterling

Cobble Paver (page 17)



Charcoal

Fjord Paver (page 14)



Bedrock

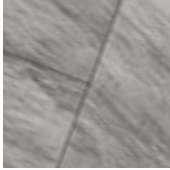

Glacier

Flagstone Paver (page 6)



Antique Brown



Sierra Grey

Holland Paver

(page 7)



Antique Brown

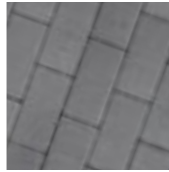

Charcoal



Natural



Sierra Grey

BC-EXCLUSIVE COLOUR (NEW)



Graphite

Holland 80mm Paver

(page 18)

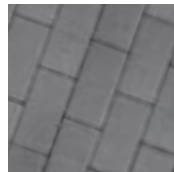

Charcoal

Mesa Flagstone Paver

(page 19)



Sierra Grey



Sterling

Navarro Paver

(page 20)



Charcoal



Sierra Grey

Roman Paver (page 8)



Antique Brown

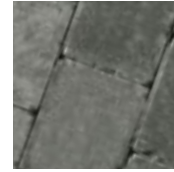

Charcoal



Desert Buff



Sierra Grey

BC-EXCLUSIVE COLOURS (NEW)

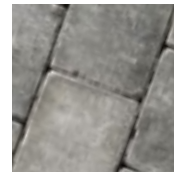

Graphite

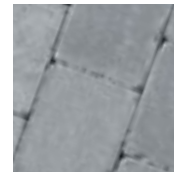

Natural

Verano Paver

(page 11)



Charcoal



Sierra Grey

Turfstone Eco Paver

(page 24)



Natural

I-Con Edger (page 46)



Charcoal



Desert Buff



Sierra Grey

Granite Edger

(page 46)



Charcoal

Bullnose Paver

(page 6)



Charcoal (Roman)



Charcoal (Smooth)

Arborwood Slab

(page 27)

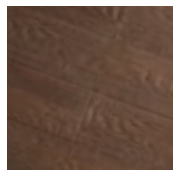

Kodiak Brown

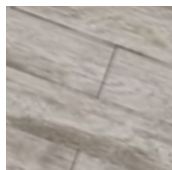

Timber Wolf Grey

Bridgewood Slab

(page 28)

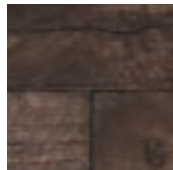

Cedar Brown



Weathered Grey

Brookside Slab

(page 29)

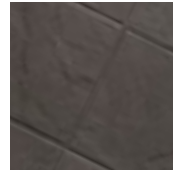

Charcoal

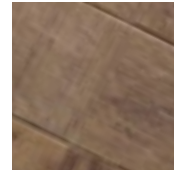

Hazel

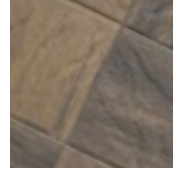

Sierra Grey

Lexington Slab

(page 31)

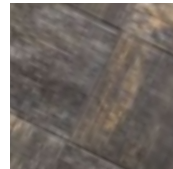

Flint

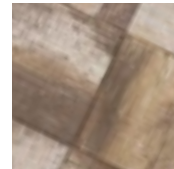

Sandstone

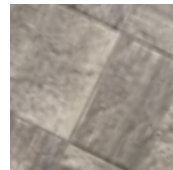

Sterling

Diamond Face Slab

(page 30)

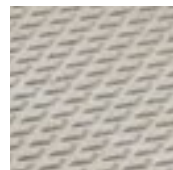

Natural

Terrace Slabs (NEW BC-Exclusive)

(page 34)



Charcoal



Graphite



Natural

Footing Pads

(page 30)



Natural

Architextures Wall

(page 36)

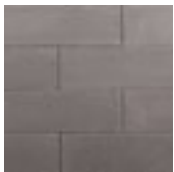

Ash

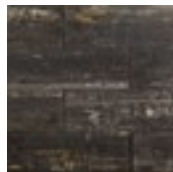

Flint



Sterling

Bridgewood Wall

(page 37)



Cedar Brown



Weathered Grey

Keystone Compac® III Wall (page 37)



Charcoal



Natural



Sierra Grey

BC-EXCLUSIVE COLOUR (NEW)



Graphite

MagnumStone™ Wall

(page 38)



Boulder Face -
Natural



Ledgestone Face -
Natural

Quarry Stone Wall

(page 39)



Charcoal



Sierra Grey

RomanStack® Wall

(page 39)



Charcoal



Desert Buff



Sierra Grey

StackStone® Wall

(page 43)



Charcoal



Desert Buff



Sierra Grey

Barkman Outdoor Kitchen Kits

(page 59)



Sierra Grey



Charcoal Accent

Quarry Stone Outdoor Kitchen Kit Countertop

(page 59)



Polished Granular Finish

Architextures Fire Pit

(pages 55)

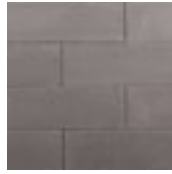

Ash

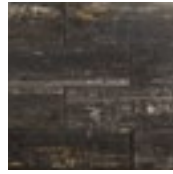

Flint

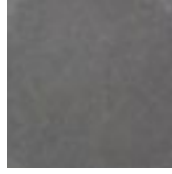

Keystone Charcoal Copping



Sterling

Rosetta® Fire Pit, Dimensional Fire Pit

(page 57)

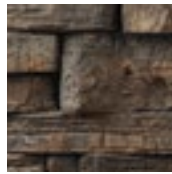

Copper Canyon



Fond du Lac



Northern Charcoal



Pacific Grey

Quarry Stone Fire Pit Kits

(page 56)



Sierra Grey

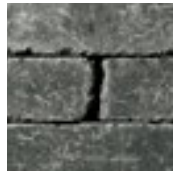

Charcoal

Smooth Quarry Stone Wall & Fire Pit

(pages 39 & 56)



Charcoal

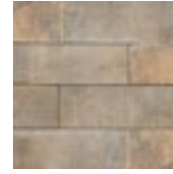

Sierra Grey

StackStone® Fire Pit

(page 58)



Charcoal



Desert Buff



Sierra Grey

StackStone® Fire Pit Copping

(page 58)



Charcoal



Natural

Bridgewood Step

(page 44)

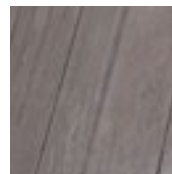

Cedar Brown

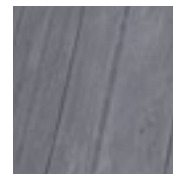

Weathered Grey

Rosetta® Dimensional and Grand Flagstone Slabs

(page 32-33)



Copper Canyon



Fond du Lac



Northern Charcoal



Pacific Grey

Rosetta® Dimensional and Irregular Steps

(page 44)

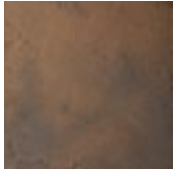

Copper Canyon



Pacific Grey

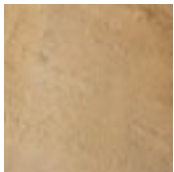

Fond du Lac



Northern Charcoal

Rosetta® Belvedere Wall

(page 40)



Copper Canyon



Pacific Grey



Fond du Lac

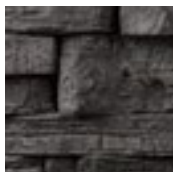

Northern Charcoal

Rosetta® Dimensional Wall

(page 41)



Copper Canyon

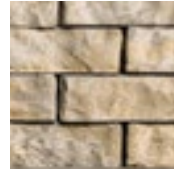

Fond du Lac



Northern Charcoal



Pacific Grey

Rosetta® Kodah Wall

(page 41)



Copper Canyon

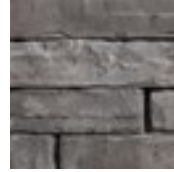

Pacific Grey



Fond du Lac

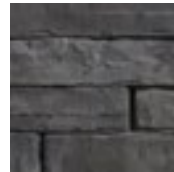

Northern Charcoal

Rosetta® Outcropping Wall

(page 42)

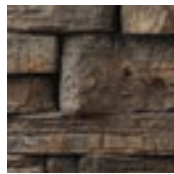

Copper Canyon

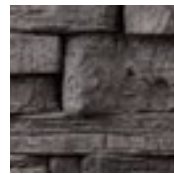

Pacific Grey



Fond du Lac

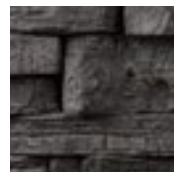

Northern Charcoal

barkman™

BarkmanConcrete.com



Steinbach Office and Distribution Centre

152 Brandt Street
Steinbach, MB
R5G 0R2
T 204 326 3445
1 800 461 2278
F 204 326 5915
Steinbach@BarkmanConcrete.com

Winnipeg Office and Distribution Centre

901 Gateway Road
Winnipeg, MB
R2K 3L1
T 204 667 3310
1 800 342 2879
F 204 663 4854
Winnipeg@BarkmanConcrete.com

Calgary Office and Distribution Centre

813 McCool Street
Box 1136,
Crossfield, AB
T0M 0S0
T 403 946 4630
F 403 946 4631
Calgary@BarkmanConcrete.com

Vancouver Office

Port Moody, BC
T 1 800 461 2278
F 604 949 0321
Vancouver@BarkmanConcrete.com

Merritt Office and Distribution Centre

1132 Midday Valley Road
Merritt, BC
V1K 1M9
T 778 661 1408

Saskatoon Distribution Centre

3550 Idylwyld Drive North,
Saskatoon, SK
S7L 6G3
T 1 800 461 2278



Made in Canada