

Circulating Baths with Advanced Programmable Temperature Controller

Operator's Manual

Models:

AP06S150
AP10S150
AP20S150
AP28S150
AP08P100
AP11P100
AP14P100
AP17P100
AP23P100
AP28P100
AP29VB3S
AP29VB5R
AP07R-20
AP07R-40
AP7LR-20
AP15R-30
AP15R-40
AP20R-30
AP28R-30
AP45R-20
AP75R-20
AP07H200
AP15H200
AP20H200
AP28H200
AP15RCAL



Table of Contents

Introduction	4
Circulating Baths with Performance Programmable Temperature Controller	5
General Safety Information	6
Safety Recommendations	7
Regulatory Compliance & Testing	8
Unpacking Your Circulator	9
Contents	9
Controls & Components	10
Performance Programmable Controller	10
Refrigerating/Heating Baths	11
Heating Only Baths	12
Calibration Baths	13
Quick-Start	14
Installation & Startup	15
General Site Requirements	15
Adding Liquid to the Bath Reservoir	16
Pump Inlet and Outlet Connections	17
External Closed Loop Circulation	17
Open Loop Circulation	18
Refrigeration Control Connections (Refrigerating/Heating Circulators only)	19
Electrical Power	19
Refrigerating / Heating Circulators	19
Heat Only Circulators and Open Bath Systems	20
Communication	21
USB Communication	22
Ethernet	22
RS232 / RS485 Serial Communication	22
External (P2) Temperature Probe	22
Controller Setup	23
Power	23
Safety Set Temperature	23
Basic Operation	25
Turning Your Circulator On	25
Controller & Touch Screen Navigation	25
Controller Navigation	25
Touch Screen Navigation	25
Menu Structure	27
Main Operational Displays (Home Screens)	28
Status Bar	28
Home Screens	29
Adjusting the Temperature Set Point	30
General Operational Settings	32
Pump Speed	33
Unit	33
Sound	33
Language	33
Display	33
Lock Out	33
Auto Restart	33
Personalize	33
Display Filter	34
SHC (Specific Heat Capacity)	34

Time and Date Settings	34
Time.....	34
Date	34
Safety Settings.....	35
High Limit / Low Limit Temperatures	35
High Alarm / Low Alarm Temperatures	35
Control	36
Probe Control	36
Auto Cool.....	36
Fluid Type.....	37
P2 - P1.....	37
PID.....	37
External Cooling Control	38
Send Internal Data USB/WEB.....	38
Reset Memory and Reboot	38
Communications and Data Logging	38
Ethernet.....	38
RS232.....	39
USB	39
RS485.....	39
Timer.....	40
Enabling / Disabling the Local Lock Out.....	41
Advanced Operation	42
Time/Temperature Programming	42
Creating a Temperature Program	42
Previewing a Program	45
Running a Program	46
Editing a Program.....	47
Saving and Uploading Programs.....	48
Event Scheduling.....	51
Creating and Installing a Personalized Home Screen.....	53
Circulator Monitoring and Control Using an Internet Browser.....	54
Calibration.....	55
Restoring All Factory Default Values	57
System Restoration	57
Changing Your Circulator's Viewing Angle.....	58
Inert Gas Purge	58
Tap Water Cooling	58
Reservoir Cover Storage	59
Routine Maintenance & Troubleshooting.....	60
Service Sub-Menu	60
Diagnostic Data Logging.....	61
Maintaining Clear Bath Water.....	61
Draining the Bath Reservoir	62
Checking the Over-Temperature / Low Liquid Level Safety Systems.....	63
Cleaning Your Circulator.....	64
Temperature Controller Removal and Re-Installation	65
Removal	65
Re-Installation.....	66
Calibrating the Touch Screen	67
Display Module Firmware Updates.....	67
Warning and Fault Messages.....	68
Warnings	68

Faults	69
Troubleshooting Chart	70
Technical Information	72
Performance Specifications	72
Reservoir Fluids	74
Application Notes	76
Tubing and Fitting Temperature Ranges	76
Fluid Compatibility	76
RS232/RS485 Communications	77
Remote ON / OFF	79
USB Data Logging	79
USB B Setup, Monitoring, and Control	80
Ethernet Configuration	80
Direct Computer to Controller Configuration	80
Wired or Wireless Network Configuration	81
TCP Control Configuration	82
External Cooling Control	83
Equipment Disposal (WEEE Directive)	85
Replacement Parts & Accessories	86
PolyScience Circulating Bath Fluids	88
Service & Technical Support	89
Warranty	89

Introduction

Thank you for choosing this Circulating Bath with Advanced Programmable Temperature Controller. It is intended for the precise temperature control of suitable liquids in a reservoir. Extremely easy to use and maintain, it combines design innovation with highly intuitive operation to deliver convenient and versatile liquid temperature control for a wide range of applications.



WARNING: PolyScience Circulating Baths are not intended for directly controlling the temperature of foods, pharmaceuticals, medicines, or other objects which may be ingested by or injected in humans or animals. Any such objects must be isolated from contact with the bath fluid and bath surfaces.

Here are some of the features that make your Circulating Bath so user-friendly:

- Intuitive touch screen operation
- OpenMode time/temperature programming (no restriction on the number of programs or steps)
- Selection of seven different temperature displays, including time-temperature graphing
- Powerful variable-speed pressure/suction pump with external circulation capability
- 180° viewing radius (Swivel 180™ rotating control head)
- DuraTop™ heat and chemical resistant top plate
- LidDock™ self-storing reservoir cover (integrated baths only)
- Built-in temperature protection
- Suitable for use with Class III flammable bath fluids per DIN 12876-1

It will take you very little time to get your new Circulating Bath installed and running. This Operator's Manual is designed to guide you quickly through the process. We recommend that you read it thoroughly before you begin.







Circulating Baths with Advanced Programmable Temperature Controller

Model Type	Reservoir Capacity	Temperature Range	
		°C	°F
AP07R-20 Refrigerating/Heating	7 liter	-20° to 200°C	-4° to 392°F
AP07R-40 Refrigerating/Heating	7 liter	-40° to 200°C	-40° to 392°F
AP7LR-20 Refrigerating/Heating	7 liter	-20° to 200°C	-4° to 392°F
AP15R-30 Refrigerating/Heating	15 liter	-30° to 200°C	-22° to 392°F
AP15R-40 Refrigerating/Heating	15 liter	-40° to 200°C	-40° to 392°F
AP20R-30 Refrigerating/Heating	20 liter	-30° to 200°C	-22° to 392°F
AP28R-30 Refrigerating/Heating	28 liter	-30° to 200°C	-22° to 392°F
AP45R-20 Refrigerating/Heating	45 liter	-25° to 135°C ⁽¹⁾	-13° to 275°F ⁽¹⁾
AP75R-20 Refrigerating/Heating	75 liter	-20° to 100°C ⁽¹⁾	-4° to 212°F ⁽¹⁾
AP07H200 Heating Only	7 liter	Ambient +10° to 200°C	Ambient +20° to 392°F
AP15H200 Heating Only	15 liter	Ambient +10° to 200°C	Ambient +20° to 392°F
AP20H200 Heating Only	20 liter	Ambient +10° to 200°C	Ambient +20° to 392°F
AP28H200 Heating Only	28 liter	Ambient +10° to 200°C	Ambient +20° to 392°F
AP06S150 Stainless Steel Open Tank	6 liter	Ambient +10° to 150°C ⁽²⁾	Ambient +20° to 302°F ⁽²⁾
AP10S150 Stainless Steel Open Tank	10 liter	Ambient +10° to 150°C ⁽²⁾	Ambient +20° to 302°F ⁽²⁾
AP20S150 Stainless Steel Open Tank	20 liter	Ambient +10° to 150°C ⁽²⁾	Ambient +20° to 302°F ⁽²⁾
AP28S150 Stainless Steel Open Tank	28 liter	Ambient +10° to 150°C ⁽²⁾	Ambient +20° to 302°F ⁽²⁾
AP08P100 Polycarbonate Open Tank	8 liter	Ambient +10° to 85°C ⁽³⁾	Ambient +20 to 185°F ⁽³⁾
AP11P100 Polycarbonate Open Tank	11 liter	Ambient +10° to 85°C ⁽³⁾	Ambient +20 to 185°F ⁽³⁾
AP14P100 Polycarbonate Open Tank	14 liter	Ambient +10° to 85°C ⁽³⁾	Ambient +20 to 185°F ⁽³⁾
AP17P100 Polycarbonate Open Tank	17 liter	Ambient +10° to 85°C ⁽³⁾	Ambient +20 to 185°F ⁽³⁾
AP23P100 Polycarbonate Open Tank	23 liter	Ambient +10° to 85°C ⁽³⁾	Ambient +20 to 185°F ⁽³⁾
AP28P100 Polycarbonate Open Tank	28 liter	Ambient +10° to 85°C ⁽³⁾	Ambient +20 to 185°F ⁽³⁾
AP29VB3S Polycarbonate Viscosity	29 liter	Ambient +10° to 85°C ⁽³⁾	Ambient +20 to 185°F ⁽³⁾
AP29VB5R Polycarbonate Viscosity	29 liter	Ambient +10° to 85°C ⁽³⁾	Ambient +20 to 185°F ⁽³⁾
AP15RCAL Refrigerating/Heating Calibration Bath	15 liter	-30° to 200°C	-22° to 392°F

1. Maximum operating temperature at which $\pm 0.005^\circ\text{C}$ temperature stability can be maintained; Advanced Programmable Controller is capable of higher temperatures.
2. Maximum operating temperature for stainless steel tank. Advanced Programmable Controller is capable of higher temperatures.
3. Maximum operating temperature for polycarbonate tank. Advanced Programmable Controller is capable of higher temperatures.

General Safety Information













When installed, operated, and maintained according to the directions in this manual and common safety procedures, your Circulating Bath should provide safe and reliable temperature control. Please ensure that all individuals involved in the installation, operation, or maintenance of this Circulating Bath read this manual thoroughly prior to working with the unit.



	This symbol alerts you to a wide range of potential dangers.
	This symbol advises you of danger from electricity or electric shock.
	This symbol indicates that a hot surface may be present.
	This symbol marks information that is particularly important.
	This symbol indicates alternating current.
	These symbols on the Power Switch / Circuit Breaker indicate that they place the main power supply ON / OFF.
	This symbol on the Power Key indicates that it places the unit in a standby mode. It DOES NOT fully disconnect the unit from the power supply.

**Read all instructions pertaining to safety, set-up, and operation.
Proper operation and maintenance is the user's responsibility.**

Safety Recommendations

To prevent injury to personnel and/or damage to property, always follow your workplace's safety procedures when operating this equipment. You should also comply with the following safety recommendations:

	<p>WARNING:</p> <p>This Circulating Bath is suitable for use with Class III flammable fluids per DIN 12876-1. A fire hazard may be present.</p> <p>Be aware of the chemical hazards that may be associated with the bath fluid used. Observe all safety warnings for the fluids used as well as those contained in the material safety data sheet.</p> <p>Explosive gas mixtures may accumulate if used with insufficient ventilation. Use this Circulating Bath in a well ventilated area or beneath a suitable fume hood only.</p> <p>Use only recommended bath fluids; see <i>Technical Information</i> in the rear of this manual for recommended fluids.</p> <p>Use only non-acid bath fluids.</p> <p>WARNING: When using Class III flammable fluids per DIN 12876-1, the user must attach the following warning labels to the front of the unit so that they are well visible:</p>					
	<table border="1"> <tr> <td data-bbox="337 779 695 890"> <p>Warning Label W09 Colors: Yellow/black</p> </td> <td data-bbox="703 779 857 890">  </td> <td data-bbox="865 779 1411 890"> <p>Danger Area. Attention! Observe instructions (operating manual, safety data sheet)</p> </td> </tr> <tr> <td data-bbox="337 890 695 1234"> <p>Mandatory Label M018 Colors: Blue/white</p> <p>or</p> <p>Semi S1-0701 Table A1-2 #9 Colors: Blue/white</p> </td> <td data-bbox="703 890 857 1234">   </td> <td data-bbox="865 890 1411 1234"> <p>Carefully read the user information prior to beginning operation. Scope: EU</p> <p>Carefully read the user information prior to beginning operation. Scope: NAFTA</p> </td> </tr> </table>	<p>Warning Label W09 Colors: Yellow/black</p>		<p>Danger Area. Attention! Observe instructions (operating manual, safety data sheet)</p>	<p>Mandatory Label M018 Colors: Blue/white</p> <p>or</p> <p>Semi S1-0701 Table A1-2 #9 Colors: Blue/white</p>	 
<p>Warning Label W09 Colors: Yellow/black</p>		<p>Danger Area. Attention! Observe instructions (operating manual, safety data sheet)</p>				
<p>Mandatory Label M018 Colors: Blue/white</p> <p>or</p> <p>Semi S1-0701 Table A1-2 #9 Colors: Blue/white</p>	 	<p>Carefully read the user information prior to beginning operation. Scope: EU</p> <p>Carefully read the user information prior to beginning operation. Scope: NAFTA</p>				
	<p>WARNING:</p> <p>Always connect the power cord on this Circulator to a grounded (3-prong) power outlet. Make certain that the outlet is the same voltage and frequency as your unit.</p> <p>Never operate the Circulator with a damaged power cord.</p> <p>Always turn the Circulator OFF and disconnect mains power before performing any maintenance or service.</p>					
	<p>WARNING:</p> <p>Never operate the Circulator without bath fluid in the reservoir. Periodically check the reservoir to ensure that the liquid depth is within acceptable levels. Always refill the reservoir using the same bath fluid type that is already in the reservoir. Bath oil must not contain any water contaminants and should be preheated to the actual bath temperature before adding as there is an explosion hazard at high temperatures.</p> <p>Always drain all fluid from the reservoir before moving or lifting your Circulator. Be sure to follow your organization's procedures and practices regarding the safe lifting and relocation of heavy objects.</p>					

	<p>WARNING:</p> <p>Always allow the bath fluid to cool to ambient temperature before draining.</p> <p>The reservoir cover, top deck, and/or external pump connections may become hot with continuous use. Exercise caution when touching these parts.</p> <p>Always keep within the 85°C maximum operating temperature limit if using a polycarbonate tank.</p>
	<p>WARNING: It is the user's responsibility to properly decontaminate the unit in the event hazardous materials are spilled on exterior or interior surfaces. Consult manufacturer if there is any doubt regarding the compatibility of decontamination or cleaning agents.</p>

Regulatory Compliance & Testing

Canada USA (60 Hz units)

Safety Requirements for Electrical Equipment for Measurement, Control and Laboratory Use, Part 1: General Requirements (CAN/CSA C22.2 No. 61010-1-12)

Safety Requirements for Electrical Equipment for Measurement, Control and Laboratory Use, Part 1: General Requirements (UL 61010-1:2012)

Safety Requirements for Electrical Equipment for Measurement, Control and Laboratory Use, Part 2-010: Particular Requirements for Laboratory Equipment for the Heating of Materials (CSA 61010-2-010:15)

Safety Requirements for Electrical Equipment for Measurement, Control and Laboratory Use, Part 2-010: Particular Requirements for Laboratory Equipment for the Heating of Materials (UL 61010-2-010:2015)

Safety Requirements for Electrical Equipment for Measurement, Control and Laboratory Use, Part 2-051: Particular Requirements for Laboratory Equipment for Mixing and Stirring (CSA 61010-2-051:15)

Safety Requirements for Electrical Equipment for Measurement, Control and Laboratory Use, Part 2-051: Particular Requirements for Laboratory Equipment for Mixing and Stirring (UL 61010-2-051:2015)

CE (50 Hz units)

Machinery Directive 2006/42/EC

EC Electromagnetic Compatibility Directive 2014/30/EU

RoHS Directive 2011/65/EU

IEC 61010-1/EN 61010-1:2010

IEC 61010-2-010/EN 61010-2-010:2014

IEC 61010-2-051/EN 61010-2-051:2015

IEC 61326:2012/EN 61326:2013

Unpacking Your Circulator

Your Circulator was packed in a special carton or cartons. You should keep the packaging, along with all packing materials, until the unit has been installed and you are certain it is working properly.

	CAUTION: Remove any loose packing material that may have fallen into the heater/pump housing during shipping. Before powering up, check that nothing remains around the heater or Circulator pump.
---	---

We recommend that you begin using your Circulator immediately to confirm proper operation, since beyond one week you may be eligible for warranty repair only (rather than replacement). You'll find complete warranty information in the back of this manual.

	WARNING: Keep unit upright when moving. Be sure to follow your company's procedures and practices regarding the safe lifting and relocation of heavy objects.
---	--

Contents

The items included with your Circulator will vary depending on which model Circulating Bath you purchased.

	Refrigerating / Heating Bath	Heating Only Bath
Resource Disk with Operator's Manual	•	•
Reservoir Cover(s)	•	•
3-ft / 0.91 m IEC to IEC Power Cord	•	
6-ft / 1.82 m IEC to Mains Power Cord	•	•
Refrigeration Control Cable	•	
Fittings	1/4 in. NPT to 3/16 in. barbed adapter ⁽¹⁾ 1/4 in. NPT to 1/4 in. barbed adapter ⁽¹⁾ 1/4 in. NPT to 3/8 in. barbed adapter ⁽¹⁾ 1/4 in. NPT to M16 barbed adapter ⁽²⁾	
Cooling Coil	N/A	Integral
Bath Lid Sleeves ⁽³⁾	Two each 3 mm, 4 mm, and 6 mm openings	
Certificate of Compliance	•	•
Flash Drive	•	•
Pt100 External Temperature Probe ⁽³⁾	•	•
Quick-Start Guide	•	•

1. 60Hz and 50Hz models
2. 50Hz models only
3. Included only with Calibration Baths (AP15RCAL)

Controls & Components

Advanced Programmable Controller

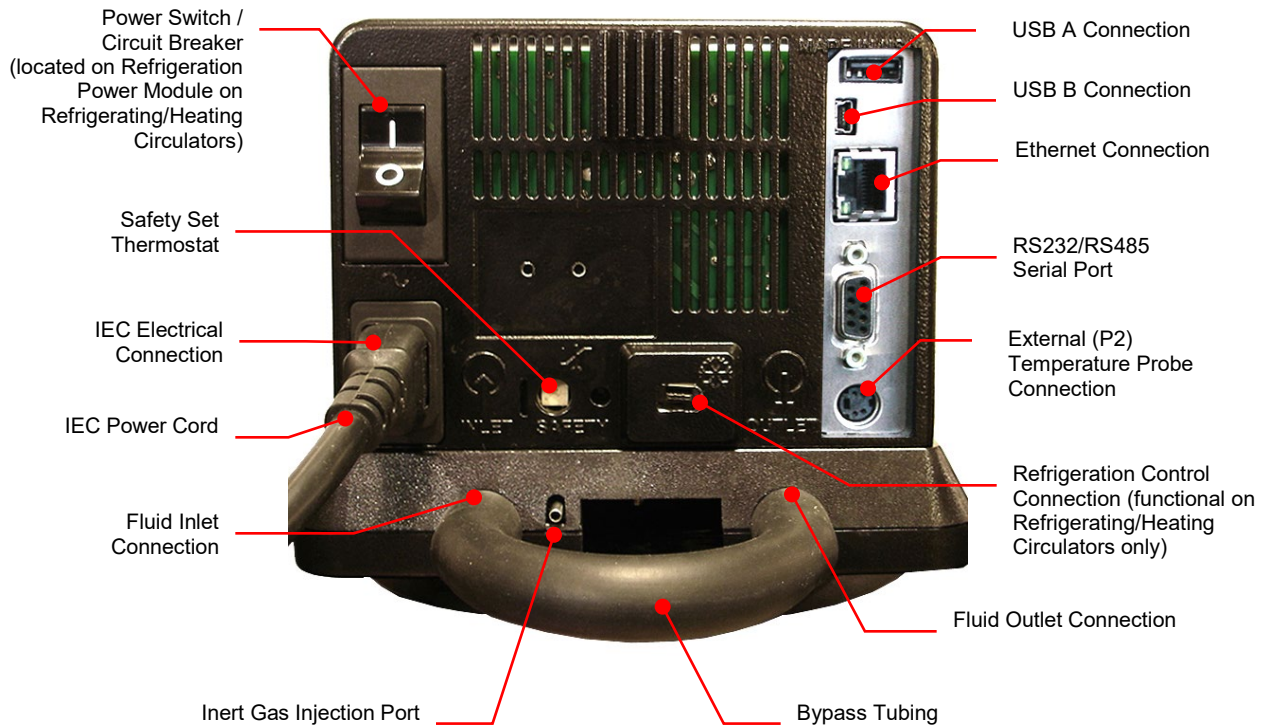

Refrigerating/Heating Baths

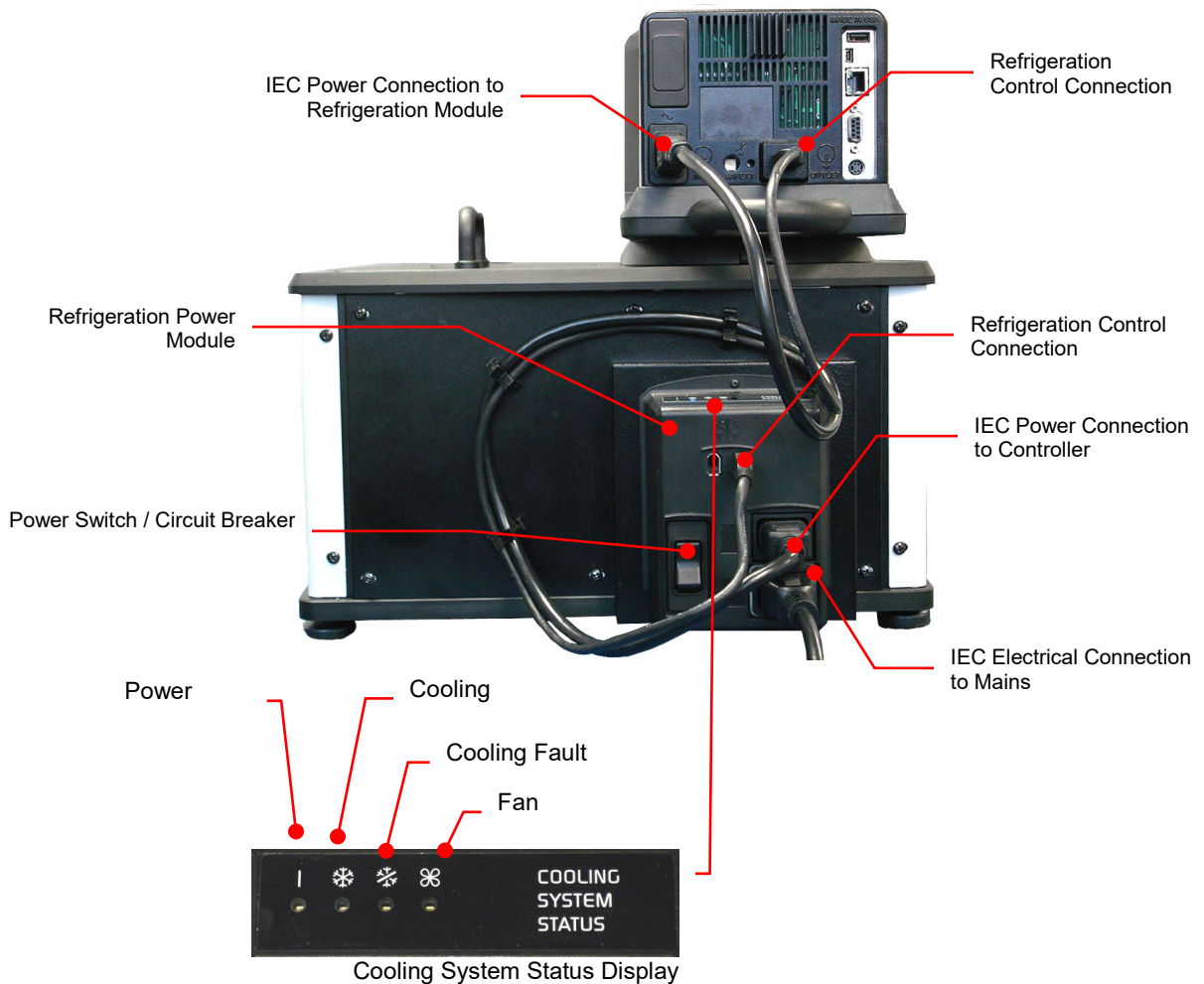

Heating Only Baths

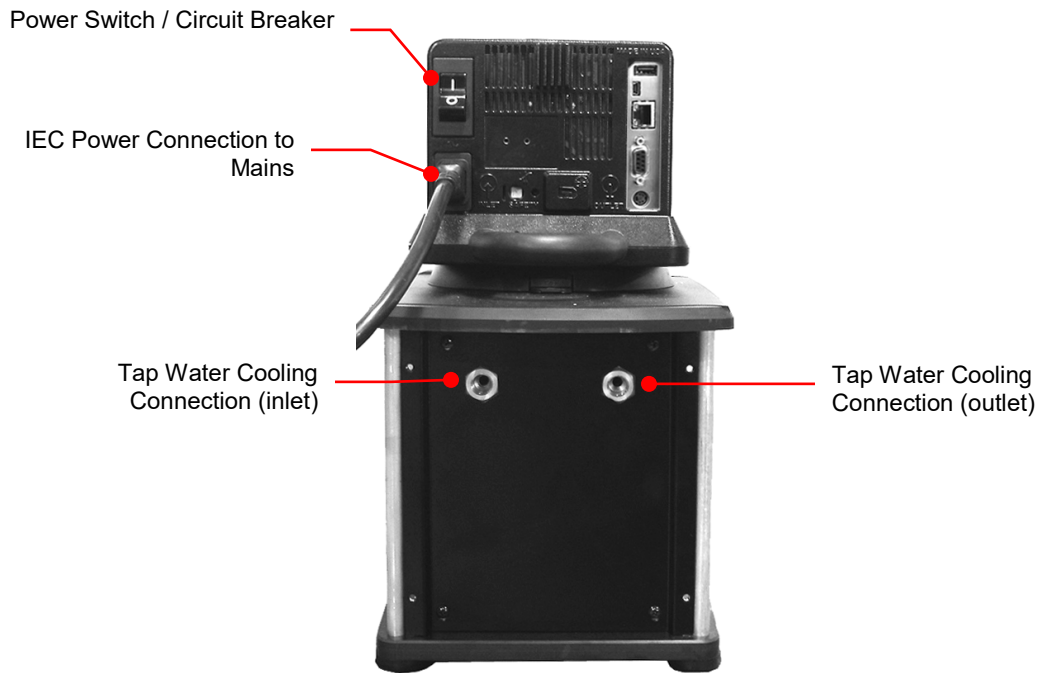

WARNING: To avoid the potential for burns, allow the Circulator to cool completely before cleaning or performing any maintenance.

Calibration Baths



Quick-Start

Unless otherwise specified, quick-start instructions apply to all models.

See *Installation & Startup* for additional information.

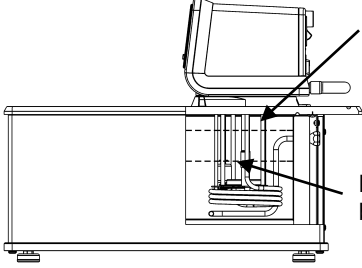
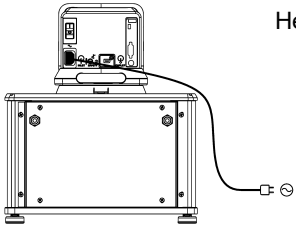
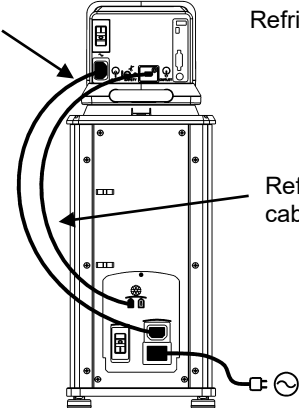
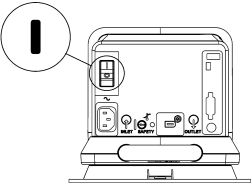
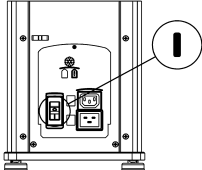
1	Fill reservoir with fluid	 <p>Maximum: 1 in. / 2.54 cm below underside of top deck</p> <p>Minimum: 3.0 in. / 7.6 cm below underside of top deck</p>
2A	Connect all electrical power cords and control cables	 <p>Heating only models</p>
2B		 <p>IEC power cord from Controller to Refrigeration Power Module</p> <p>Refrigerating / Heating models</p> <p>Refrigeration control cable</p>
3A	Place Power Switch / Circuit Breaker in ON position	 <p>Heating only models</p>
3B		 <p>Refrigerating / Heating models</p>

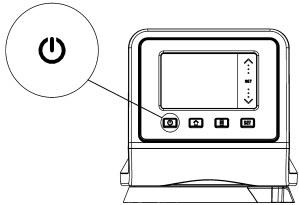
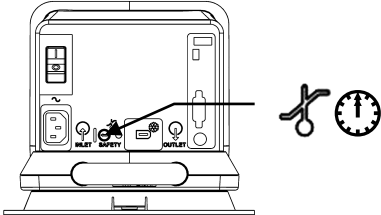
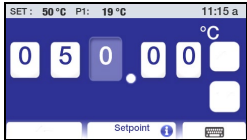
4	Turn Controller "ON"	
5	Set safety thermostat	
6	Set Temperature Set Point	

Installation & Startup

Your Circulating Bath with Advanced Programmable Temperature Controller is designed to be simple to set-up and install. The only tools required are a Philips-head screwdriver and a container for adding water or other suitable fluid to the bath reservoir.





General Site Requirements

Locate your Circulator on a level surface free from drafts and direct sunlight. Do not place it where there are corrosive fumes, excessive moisture, high room temperatures, or in excessively dusty areas.

Refrigerating / Heating Circulators must be 10.2 cm / 4 inches or more away from walls or vertical surfaces so that airflow is not restricted.

Avoid voltage drops by using properly grounded power outlets wired with 14 gauge or larger diameter wire and if possible, be close to the power distribution panel. The use of extension cords is not recommended; this will reduce the potential for problems caused by low line voltage.

Adding Liquid to the Bath Reservoir

	WARNING: When using Class III flammable fluids per DIN 12876-1, the user must attach the following warning labels to the front of the unit so that they are well visible:		
	Warning Label W09 Colors: Yellow/black		Danger Area. Attention! Observe instructions (operating manual, safety data sheet)
Mandatory Label M018 Colors: Blue/white or Semi S1-0701 Table A1-2 #9 Colors: Blue/white		Carefully read the user information prior to beginning operation. Scope: EU	
		Carefully read the user information prior to beginning operation. Scope: NAFTA	

	WARNING: Read the safety data sheet for the bath fluid being used carefully before filling reservoir. WARNING: See <i>Technical Information</i> in the rear of this manual for a list of compatible liquids. WARNING: If the proper fluid level is not maintained, the heater coil may become exposed and possibly damaged (fluid level too low) or the bath may overflow (fluid level too high).
---	--

The liquid in the reservoir should be maintained at a depth between 1 inch / 2.54 cm and 3.0 inches / 7.6 cm below the underside of the bath's top deck. Upon start up, it may be necessary to add fluid to the bath to compensate for the fluid required for external circulation. Likewise, be sure to compensate for fluid displacement when placing samples or other materials in the Circulator's reservoir.

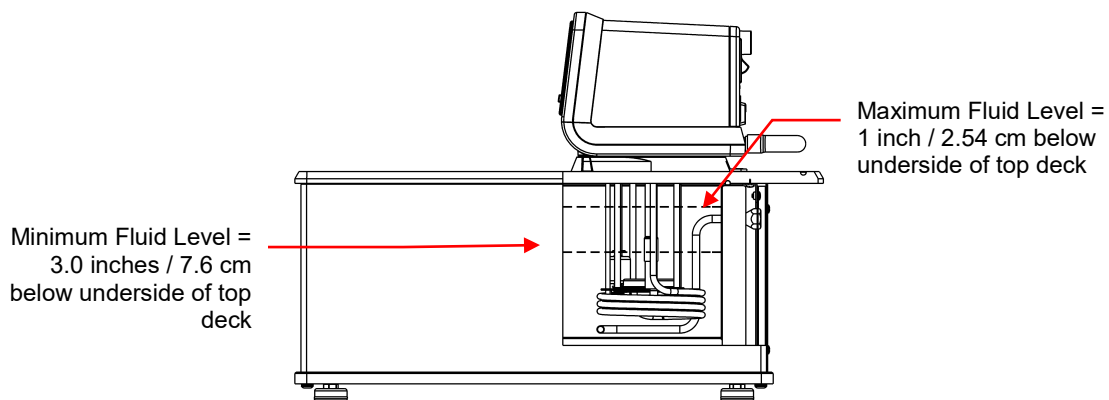

	WARNING: Always drain all fluid from the reservoir before moving or lifting your Circulator. Be sure to follow your organization's procedures and practices regarding the safe lifting and relocation of heavy objects.
---	--

	WARNING: To avoid the potential for burns, allow the Circulator to cool completely before cleaning or performing any maintenance.
---	--

Pump Inlet and Outlet Connections

	<p>WARNING: When connecting tubing to an external application, it is the user's responsibility to make sure that the tubing and fittings connected to the Circulator are suitable for the fluid being used and the temperature range of operation.</p> <p>CAUTION: The Circulator's bypass tubing is secured to the fluid inlet and outlet connections by high temperature nylon hose clamps, which can be removed by carefully cutting them with diagonal cutters.</p> <p>CAUTION: Secure the tubing to the inlet and outlet fittings using hose clamps with a minimum ID of 7/8 inch (22 mm). Do not operate the unit without hose clamps.</p>
---	---

	<p>WARNING: If the Circulating Bath will not be used for external circulation, the inlet and outlet ports should remain connected using the Buna N bypass tubing provided with the unit.</p>
---	---

The pump inlet and outlet ports are female ¼ inch NPT connections that permit use of barbed tubing adapters or hard plumbing fittings. ½ inch (13mm) ID tubing may also be slid over these connections and held in place with a hose clamp.

If the pump inlet and outlet are not used for external circulation, the Bypass Tubing provided with the unit should be left in place in order to optimize fluid mixing within the reservoir.

The nylon barbed tubing adapter fittings supplied with the unit are intended for applications from -40° to 93°C. For applications above 93°C, brass, stainless steel, or Teflon® fittings are recommended. ¼ inch NPT to M16 stainless steel male adapter fittings are provided with all 50Hz models.

	<p>NOTE: The use of quick-connect fittings is not recommended as they typically restrict flow rate.</p>
--	--

External Closed Loop Circulation

Connect the pump inlet and outlet to the external apparatus. To maintain adequate flow, avoid restrictions in the tubing. When connecting the Circulator to more than two closed loops, the use of a manifold made of "Y" adapters to divide the fluid into multiple banks is recommended. After setting up multiple closed loops, check for adequate flow at the return manifold of each loop and check that the bath fluid is at an adequate level. A booster pump may be added to closed loops without damaging the Circulator's pump.

The temperature control stability of a closed loop system is better at the external apparatus than in the Circulator reservoir (provided the control point of the apparatus represents a constant load and is well insulated). For example, if you circulate fluid through a viscometer at 50°C, the temperature variation observed in the Circulator reservoir may be ±0.1°C while the temperature variation in the viscometer may be only ±0.05°C.

Although temperature stability is generally better at the external apparatus control point, depending on the length of tubing used and the efficiency of the insulation, the actual temperature reading at the external apparatus may be slightly different than the temperature reading at the Circulator reservoir.

Open Loop Circulation

The duplex (pressure/suction) pump permits circulation to and from an external open bath. To prevent siphoning when the Circulating Bath is turned off, position both baths so that the two fluid levels are at the same elevation.

Connect the pump inlet and outlet to the external bath using tubing of the same diameter and length. The same size fittings should also be used on both the inlet (suction) and outlet (pressure). This helps ensure a balanced flow. A restricting valve or pinch clip should be installed in the pressure (outlet) tubing and adjusted to match the return suction (inlet) flow rate. Cut the external end of the suction tube into a “V” shape so that the tube will not seal itself against the wall of the external tank. Both the pressure and suction tubing should be securely fastened to the external tank to prevent movement during use.

When using flexible tubing, the suction tubing must have a wall thickness that will not collapse under vacuum, particularly when going around bends.

Circulating Bath Height Regulation — Position the ends of the pressure and suction tubes at the desired maximum fluid level in the external bath and fill the bath to that level. Fill the Circulating Bath to a height one inch (25mm) below the top of the reservoir. Start the pump and adjust the restricting valve/pinch clip on the outlet tubing until the liquid height in both baths remains constant. Add fluid to the baths as needed to compensate for the fluid in the inlet and outlet lines.

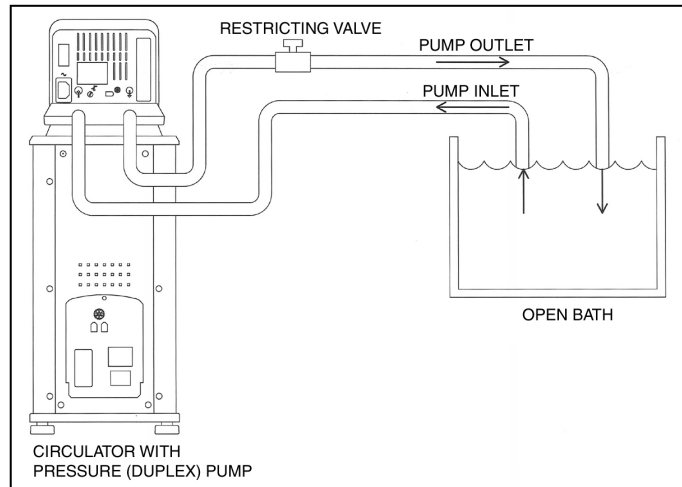

Refrigeration Control Connections (Refrigerating/Heating Circulators only)

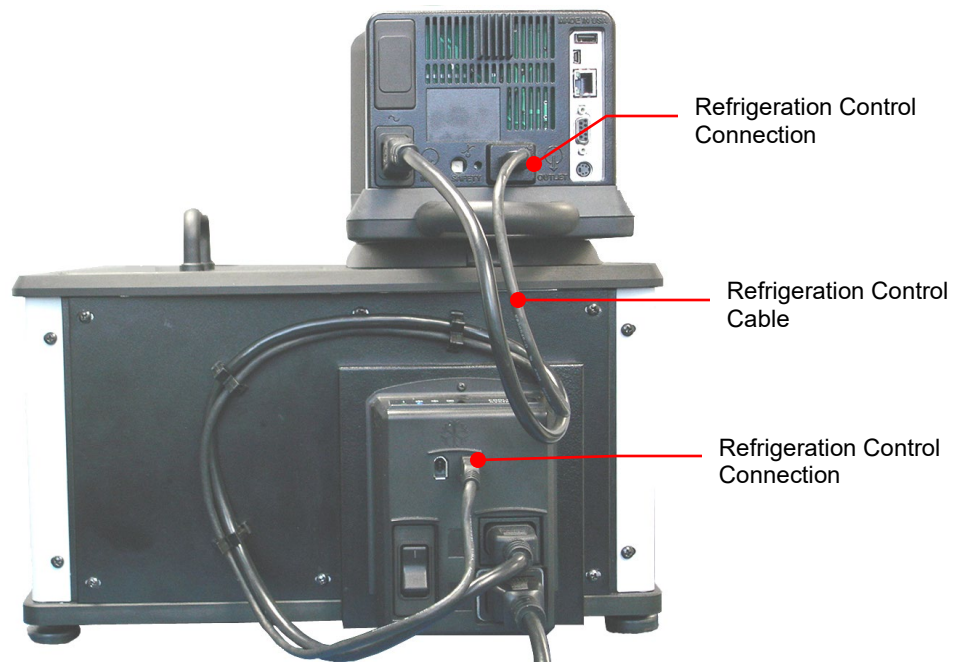

Electrical Power



WARNING: The Circulator's power cord must be connected to a properly grounded electrical receptacle. Make certain that this electrical outlet is the same voltage and frequency as your Circulator. The correct voltage and frequency for your Circulator are indicated on the identification label on the back of the Controller.



CAUTION: The use of an extension cord is not recommended. If one is necessary, it must be properly grounded and capable of handling the total wattage of the unit. The extension cord must not cause more than a 10% drop in voltage to the unit.

Refrigerating / Heating Circulators

Attach the 3-ft / 0.91 m power cord to the IEC electrical connectors on the Temperature Controller (male) and the Refrigeration Power Module (female).

Attach the 6-ft / 1.8 m power cord to the IEC electrical connection on the Refrigeration Power Module and then plug the male connector into the Mains electrical outlet.

Place the Power Switch / Circuit Breaker on the Refrigeration Power Module in the ON position. An hour glass will appear on the Temperature Controller's display while the Circulator completes an initialization sequence. Once completed, "Standby" will appear on the display; the Power Key will also light.

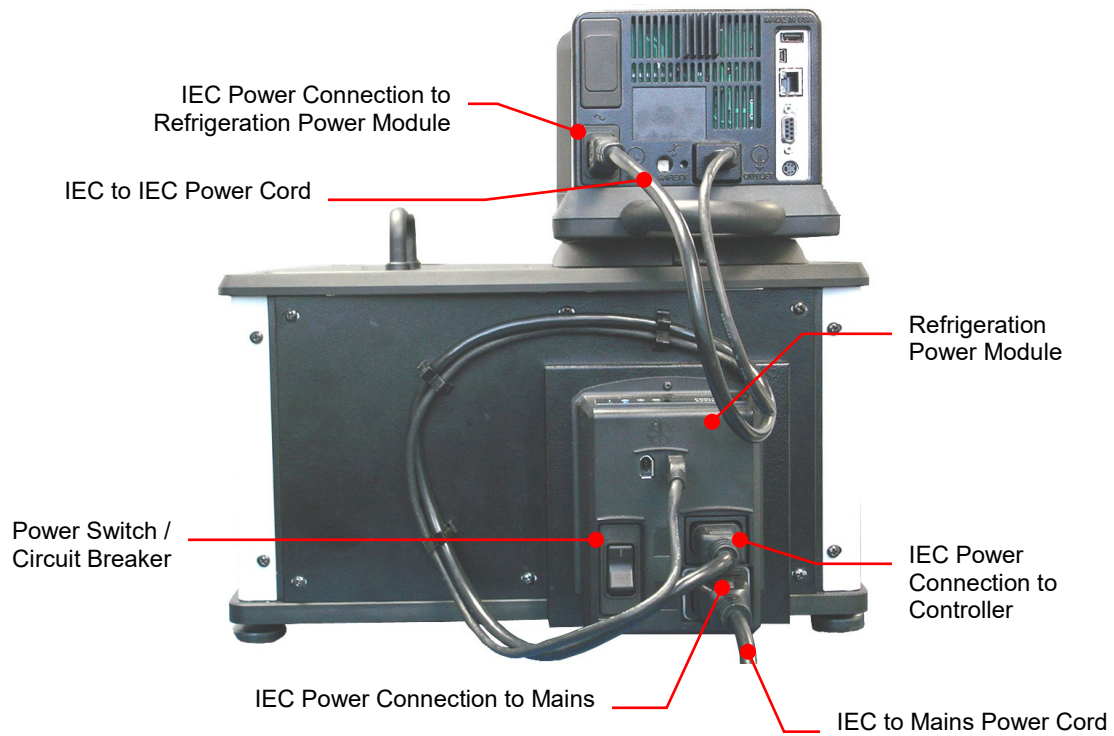

Heat Only Circulators and Open Bath Systems

Attach the 6-ft / 1.8 m power cord to the IEC electrical connection on the Temperature Controller and then plug the male connector into the Mains electrical outlet.

Place the Power Switch / Circuit Breaker on the Temperature Controller in the ON position. The display on the Controller will light and "Standby" will appear on the display; the Power Key will also light.

Communication

The Advanced Programmable Controller features a variety of connectivity options. Following are some typical ways you can use them to monitor and control the operation of your Circulator.

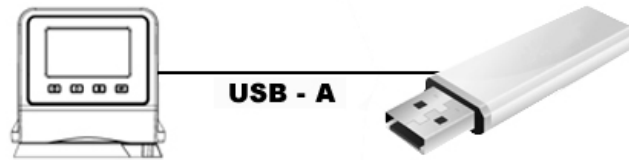
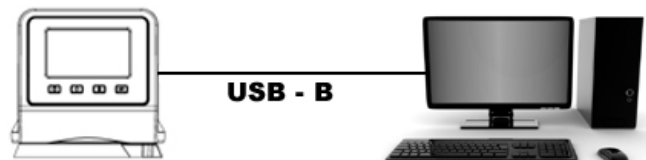

USB Communication

Two USB ports (A and B) are provided on the rear of the Temperature Controller for use with USB flash drives to log temperature data and store and/or transfer time/temperature programs. See *Basic Operation, Communications and Data Logging* for more information.

Ethernet

An Ethernet port is provided on the back of the Temperature Controller to enable you to connect your Circulator to a computer network.

RS232 / RS485 Serial Communication



CAUTION: Always turn electrical power to the Circulator OFF before making a connection to the serial (DB9) port.

Your Circulator features RS232 / RS485 serial communication for remote data logging and control capability. A DB9 connector is provided on the rear of the Temperature Controller for this purpose. See *Basic Operation, Communications and Data Logging* for set up information.

The serial interface should be connected to a serial communication port on a remote PC using an appropriate cable. Information on the RS232 / RS485 commands and communication protocol can be found in the *Technical Information* section of this manual.

External (P2) Temperature Probe

Your Circulator is capable of controlling temperature based on either the temperature of the internal bath or that of an external vessel or device. The connection for the optional external temperature probe is on the rear of the Temperature Controller. The Temperature Controller automatically detects the external temperature probe when it is connected. See *Replacement Parts & Accessories* for other available lengths and part numbers.



IMPORTANT NOTE FOR CALIBRATION BATHS: The PT100 external temperature probe should be inserted in the calibration reservoir.

Pin Out Diagrams — External (P2) Temperature Probe Connection

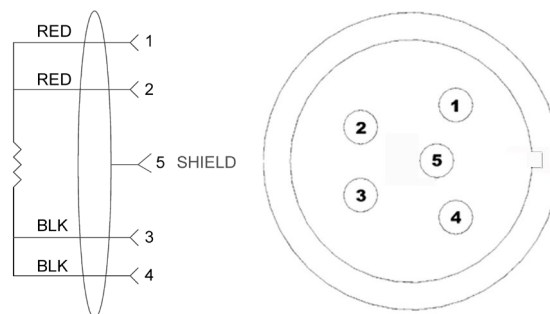

RTD SENSOR: 4 WIRE CIRCUIT, 100 OHMS @ 0 DEGREES C,
MAXIMUM OPERATING TEMPERATURE @ 200 C, CLASS A 0.003850 OHMS/DEGREES C.

Controller Setup

Power

Press . "Initializing" will appear briefly on the display, the Circulator will begin running, and the default Main Run screen will appear.



Safety Set Temperature



NOTE: The Safety Set Temperature is displayed and set in whichever temperature unit is currently selected. The default is °C. To set the temperature using °F, see *General Operational Settings, Unit*.

This is a "Do Not Exceed" temperature setting for your Circulator and is the temperature at which the heater will be turned OFF should the liquid level in the bath drop too low or the heater malfunctions. It is normally set about 5° higher than the desired operating temperature. Setting the Safety Set Temperature is a simple 4-step procedure.



WARNING: The Safety Thermostat is user-adjustable from approximately 40° to 240°C / 104° to 464°F. Do not force the indicator dial beyond the stops at either end of the dial's range.

1. Press  to access the Main menu.

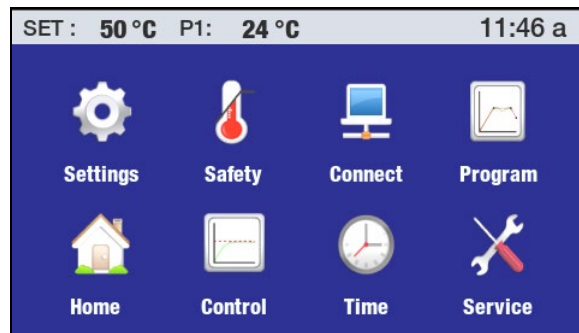

2. Touch the Safety icon to access the Safety sub-menu.

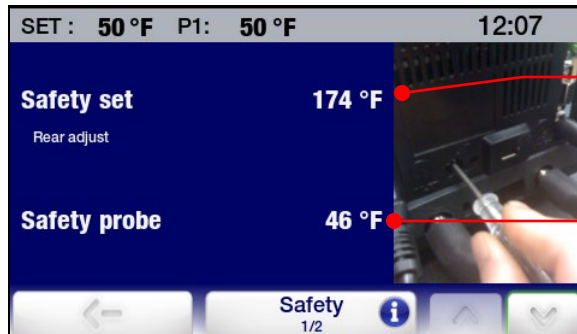

Safety Set Temperature

Current Safety Probe reading

3. Using a small, Philips head screwdriver, rotate the Safety Set Thermostat on the rear of the Temperature Controller until the desired Safety Set Temperature is displayed (clockwise to increase; counter-clockwise to decrease).
4. Press the ← icon or the  key to return to the Main Menu.

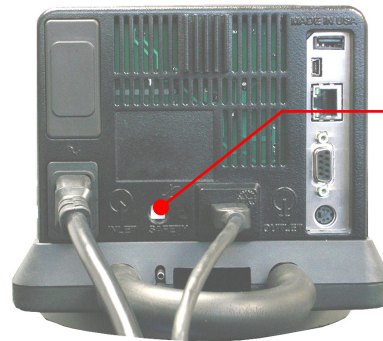

Safety Set Thermostat



Basic Operation

Turning Your Circulator On

Press the  key.

The Circulator will begin running and the Main Operational Display (Home) will appear.

Controller & Touch Screen Navigation

Controller Navigation

POWER –
Turns the Circulator's Temperature Controller ON and OFF.

SET --
Used in conjunction with various screen icons and buttons to change the set point temperature

HOME --
Returns the to the Main Operational Display (Home) from any screen

Toggles through available Home screens.

MENU --
Accesses the Temperature Controller's Main Menu (from any screen)

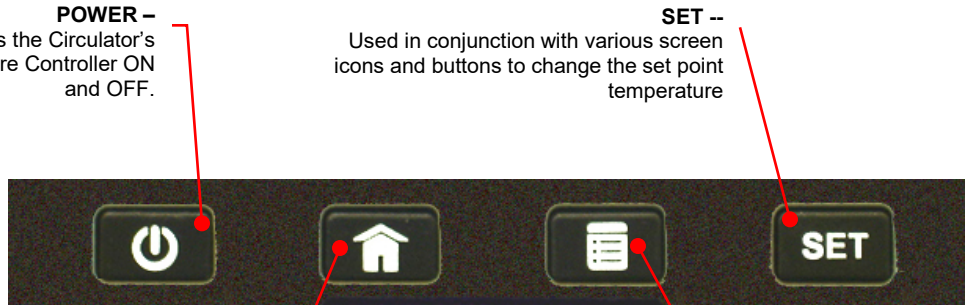

Touch Screen Navigation

Main Menu

Press  to access.

Status Bar – Appears on all screens

Accesses associated sub-menu

Return to Main Run screen (Home screen)

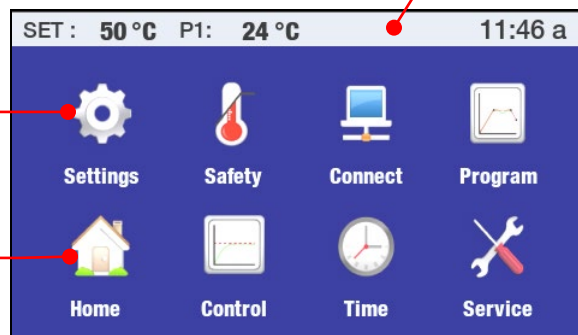

Sub-Menus

 **NOTE:** The following examples are intended to illustrate how commonly used touch screen icons function when displayed. A specific icon may or may not be displayed on a sub-menu page. The function/operation of icons not shown here are described in the sections associated with the screens on which they appear.



Sub-Menu Item -- Toggles between available choices

Previous Menu

Information - Help regarding sub-menu items

Current Setting (white letters on blue field)

Alternate Setting (blue letters on white field)

Next Page

Previous Page

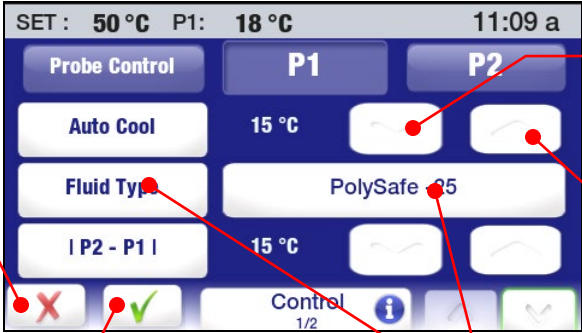

Cancel -- Cancels change to a setting

Accept -- Accepts change to a setting

Decreases Value

Increases Value

Current Setting (more than two settings available) – Touch to access other available selections

 **CAUTION:** The menu and sub-menu screens time-out and revert to the Main Operational Display (Home Screen) after approximately 30 seconds without any touch screen interaction. Any changes made will take effect automatically.

Menu Structure

Sub-Menu	Item	Description / Selections
Settings	Pump Speed Unit Sound Language Display Lock Out Auto Restart Personalize Display Filter SHC	5% to 100% °C / °F On / Off Available display languages Temperature display resolution: .XX / .XXX Yes / No Yes / No Off / PNG Display averaging: 1 to 7 seconds Specific heat capacity unit: BTU/(LB.°F) / kJ(kg/°C)
Safety	Safety Set Safety Probe High Limit Low Limit High Alarm Low Alarm	Displays current safety set temperature Displays current safety probe temperature 202°C maximum / 25°C minimum -72°C minimum / 20°C maximum 202°C maximum / 25°C minimum -72°C minimum / 20°C maximum
Connect	Ethernet RS232 USB RS485 Address	Ethernet connection 1200 to 115,200 baud Logging On / Off Addressable
Program	P1 through PXXX	Create, edit, delete, run, save, and transfer time/temperature programs. No restriction on number of programs or steps.
Control	Probe Control Auto Cool Fluid Type P2 – P1 PID External Cooling Control Send Internal Data USB/Web Reset memory and reboot	P1 (internal) / P2 (external) Set temperature at which refrigeration activates: 2° to 152°C Optimizes operation for a specific fluid type Maximum allowable temperature differential between P1 and P2 User / Factory Operating parameters for optional external cooling valve Outputs diagnostic file Resets unit to factory defaults
Time	Timer Time Date Schedule	0 to 999 minutes Time and time format Year, Month, Day Set time and date to auto-start a program
Service	Air Filter Service Interval Fluid Service Interval Clear Pump Operation Clear Cooling Operation Calibration Installation Operation Display Module Firmware Powerboard Module Firmware Cooling Module Firmware	Time remaining until air filter cleaning Time remaining until fluid replacement Reset / display number of days pump has been operating Reset / display number of days compressor has been operating Calibration table entry Number of days unit has been operating Version Version Version

Main Operational Displays (Home Screens)

Your Circulator features seven Main Operational Displays (Home screens). You can see the available choices and select a specific Home screen by pressing the  key.

Status Bar

A status bar displaying important operating information is displayed at the top of every Home and Menu screen. The information included on the status bar is determined by the type of screen on which it appears.

Home Screen Status Bar

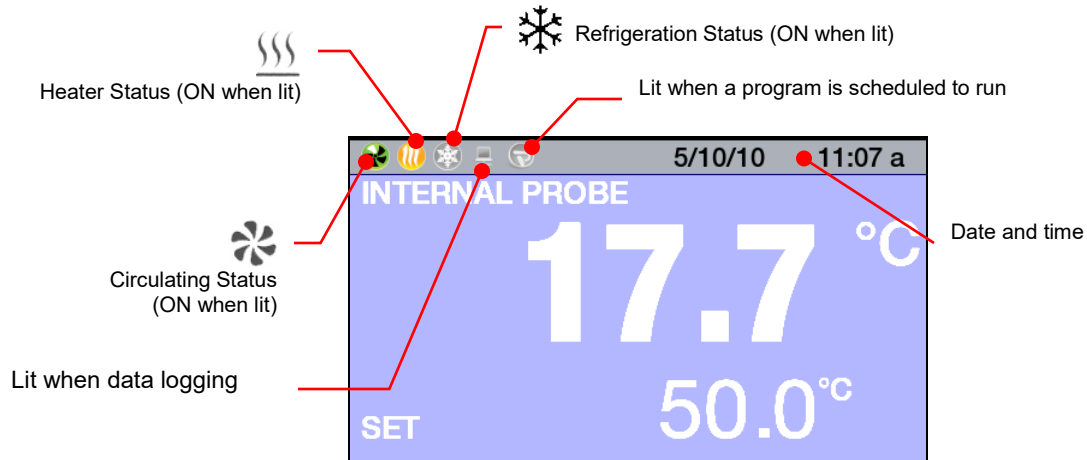

Menu and Sub-Menu Screens Status Bar

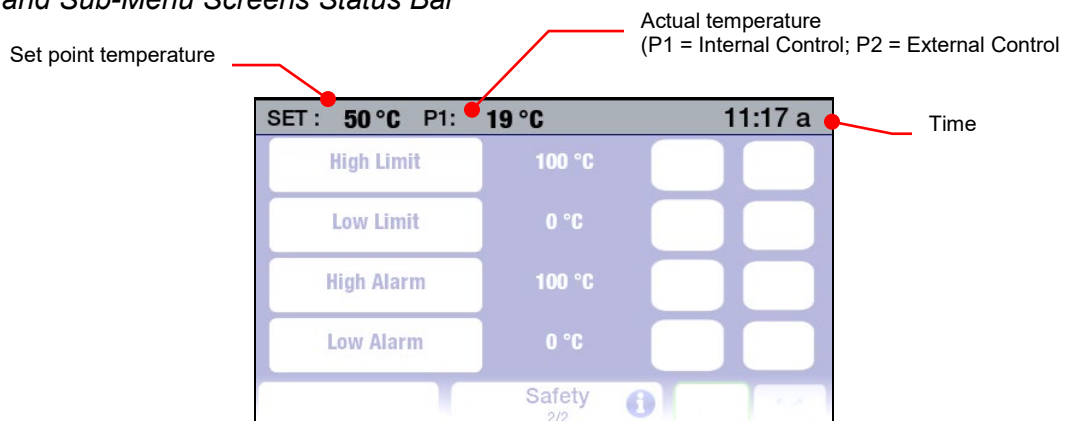

Home Screens

Primary Home Screens

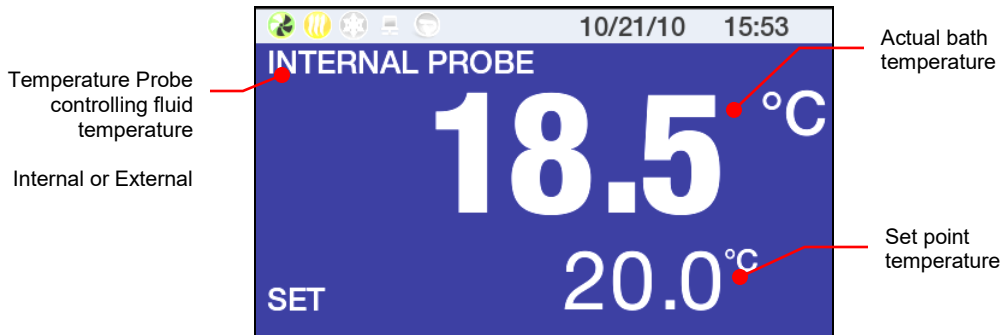

The background for this style Home screen may be either blue or black.

NOTE: On primary home screens, the actual and set point temperatures are displayed to one decimal point resolution only, regardless of the resolution selected in the Settings / Display sub-menu.

Temperature Detail Home Screens

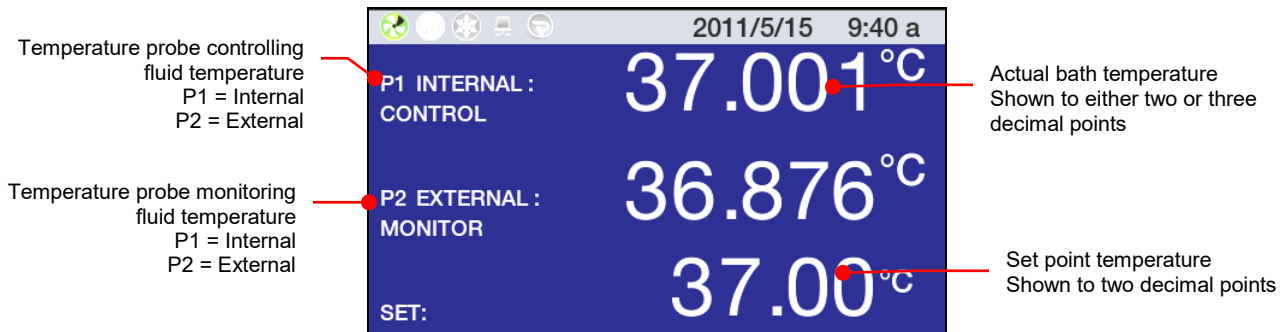

The background for this style Home screen may be either blue or black.

Temperature Trend Home Screen

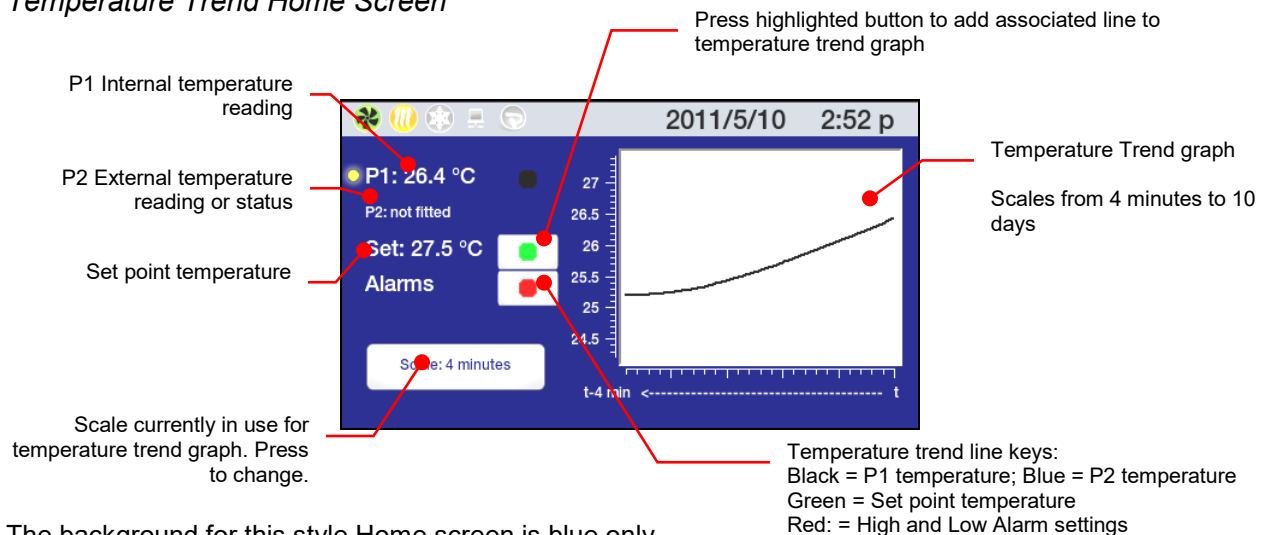

The background for this style Home screen is blue only.

Personalized Home Screen

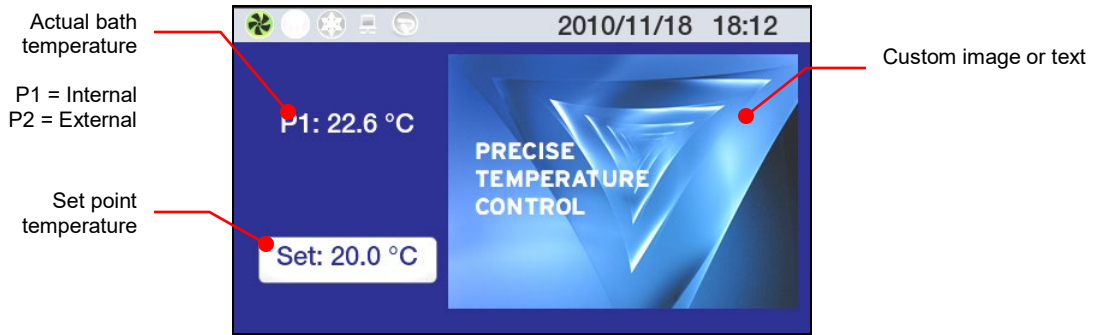

Adjusting the Temperature Set Point

This is the temperature at which the fluid in your Circulating Bath will be maintained. It may be set to one one-hundredth of a degree over a range of -50.00° to $+200.00^{\circ}$ C / -58.00° to $+392.000^{\circ}$ F. The factory default set point is $+20.00^{\circ}$ C / $+68.00^{\circ}$ C.



NOTE: Although temperature can be displayed with three decimal point resolution, set point temperatures may only be set to two decimal points.

To optimize operational flexibility, set point temperature changes can be initiated in several ways.

Controller Keypad



NOTE: To change the temperature set point while operating in the Temperature Trend Home screen, you must press the SET key on the Controller's front panel. Temperature set point cannot be changed while a program is running.

Primary Home Screen

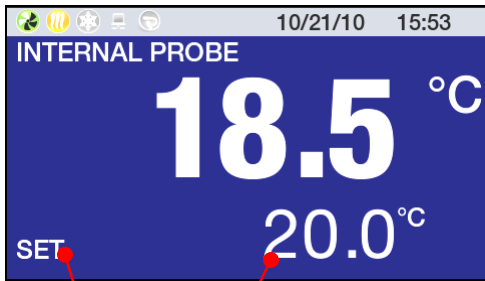

Touch SET or numerical set point value

Temperature Detail Home Screen

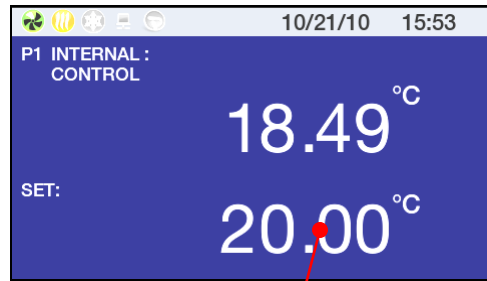

Touch numerical set point value

Personalized Home Screen

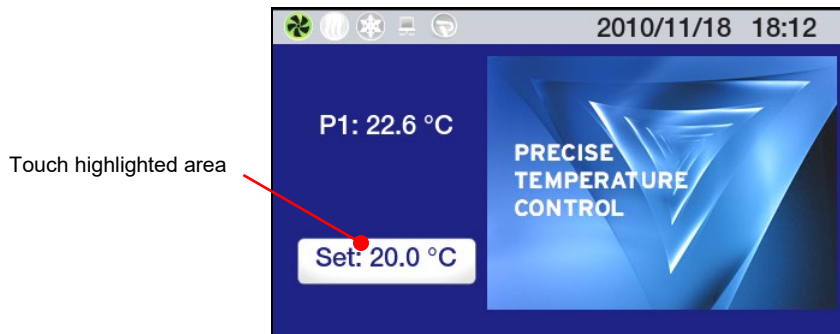

Entering the Set Point Temperature Value

Once a temperature set point change has been initiated by pressing the **SET** key or appropriate area on the display, the set point entry screen will appear.

Touch individual number field to make changes to that field

Once 9 appears in the field, it will roll to 0 and the field to its left will increment one number.



Increases displayed value

Decreases displayed value

Touch to enter values using the numeric keypad (shown on next page)

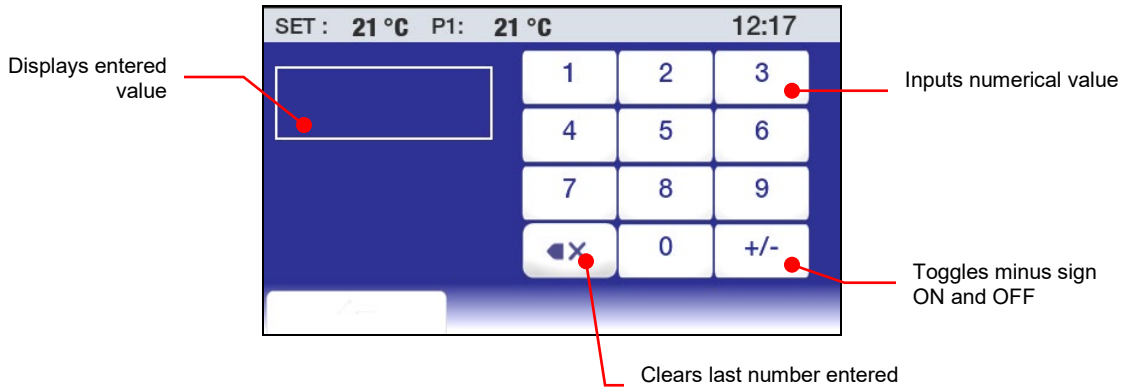

 **CAUTION:** The menu and sub-menu screens time-out and revert to the Main Operational Display (Home Screen) if approximately 30 seconds pass without any touch screen interaction. Any changes made will take effect automatically.

General Operational Settings

The Settings sub-menu is used to select the Temperature Controller's general operational characteristics.

Press  to access the Main menu.



Touch the Settings icon to access the Settings sub-menus.

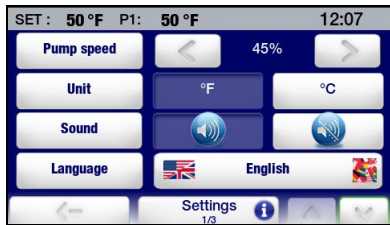

Settings – Page 1



Settings – Page 2

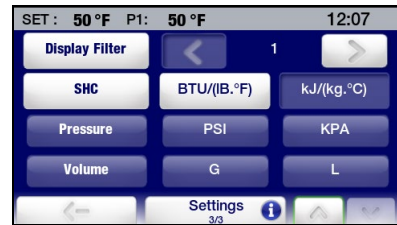

Settings – Page 3

Pump Speed — Sets pump speed. The current setting is displayed between the < (decrease) and > (increase) icons and is adjustable from 5% to 100%. Touch ✓ to accept the new value, ✕ to cancel.

Unit — Sets the unit in which temperature will be displayed. The current setting is shown in the non-highlighted (blue) field. To change, touch Unit icon or the ° icon in the highlighted (white) field. Touch ✓ to accept the new temperature unit, ✕ to cancel.

Sound — Turns sound ON and OFF. The current setting is shown in the non-highlighted (blue) field. To change, touch the Sound icon or the icon in the highlighted (white) field. Touch ✓ to accept, ✕ to cancel.

Language — Sets the language in which all menus will be displayed. The current selection is shown to the right of the Language icon. To change, touch either the left or right highlighted (white) Language field. A screen showing the available languages will appear:



The current setting is shown in the non-highlighted (blue) field. To change, touch the icon associated with the desired language. Touch ← to return to the Settings sub-menu.

Touch ✓ to advance to page 2 in the Settings sub-menu.

Display — Sets the number of decimal points in which actual and set point temperature will be displayed. The current setting is shown in the non-highlighted (blue) field. To change, touch the Display icon or the icon in the highlighted (white) field. Touch ✓ to accept, ✕ to cancel;

	NOTE: Temperature is shown to one decimal point only on the Primary (largest) display, regardless of the display setting. See <i>Main Operational Displays (Home Screens)</i> for more information.
---	--

Lock Out — Allows you to block temperature set point and other changes. While this feature is activated, the unit will remain running at the current settings. See *Basic Operation, Enabling/Disabling the Local Lock Out* for information on using this feature.

Auto Restart — This determines how the unit will begin operating after a disruption to electrical power. When YES is selected, the Circulator will begin running automatically when power is restored. When NO is selected, the Circulator will power up in the Standby mode. A message will also be displayed to alert you to the power outage. The current setting is shown in the non-highlighted (blue) field. To change, touch the Auto Restart icon or the icon in the highlighted (white) field. Touch ✓ to accept the new setting, ✕ to cancel.

	WARNING: The unit may start automatically after a disruption in electrical power.
---	--

Personalize — Allows the personalization of one of the Home screens with an image or text. See *Creating and Installing a Personalized Home Screen* for information on adding text/images.

Touch ✓ to advance to page 3 in the Settings sub-menu.

Display Filter —This setting determines the averaging time used when displaying temperature information. Higher settings will generally result in less fluctuation, while lower settings will more accurately reflect real-time temperature probe data. Use the < (decrease) and > (increase) icons to change the current setting; touch ✓ to accept the new value, ✕ to cancel.

SHC (Specific Heat Capacity)— Sets the unit (BTU or kJ) in which Specific Heat Capacity will be displayed. Works in conjunction with the Fluid Type setting in the Control sub-menu. To change, touch the SHC icon or the icon in the highlighted (white) field. Touch ✓ to accept the new setting, ✕ to cancel.

Time and Date Settings

Touch the Time icon on the Main Menu; the Time sub-menu will be displayed.

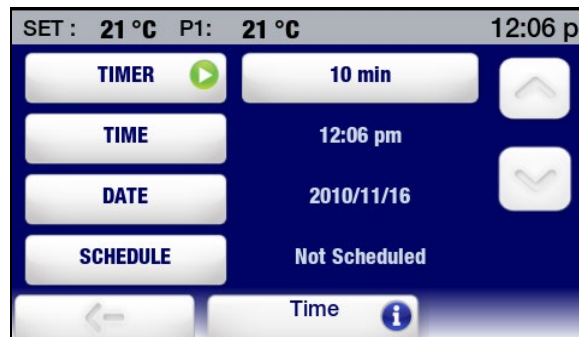

Time — Sets the time in either 12 or 24 hour format. To change, touch the Time icon or the actual displayed time. Depending on the actual time and current time format, one of the following screens will appear:

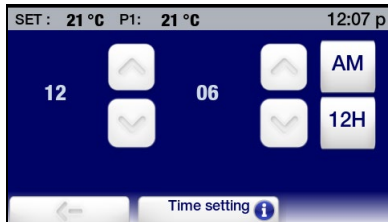

12 hour format – AM

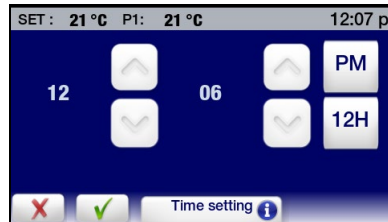

12 hour format – PM

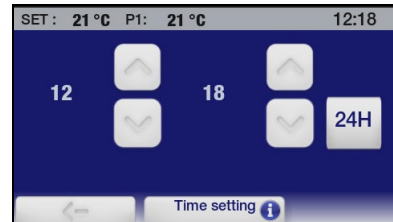

24 hour format

To change the time format, touch the 12H or 24H. Touch ✓ to accept the new setting, ✕ to cancel.

To change the time, touch the up/down arrow icons associated with the hours or minutes. You can also change the hour or minutes setting by touching the number itself; this will bring up a numeric keypad on which the correct hour or minute can be entered. Touch ✓ to accept the new setting, ✕ to cancel.

Date — Sets the date in Year/Month/Day format. To change, touch the Date icon or the actual displayed date; the following screen will appear:

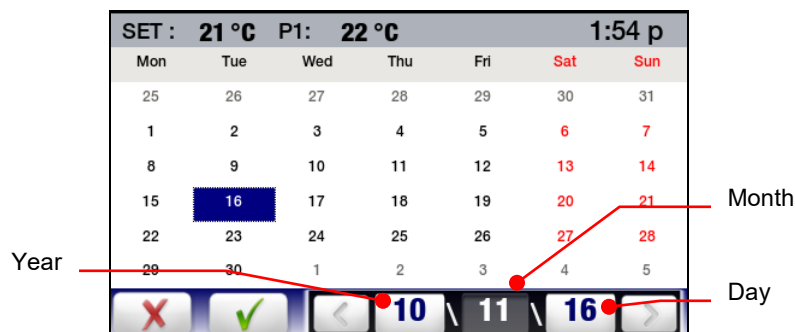

To change the current setting, press the appropriate Year, Month, or Day icon and then touch < or >. You can also change the Day by simply pressing the appropriate date on the calendar. Touch ✓ to accept the new setting, ✕ to cancel.

	<p>NOTE: See <i>Basic Operation, Timer and Advanced Operation, Event Scheduling</i> for information on the Timer and Schedule functions.</p>
---	---

Safety Settings

Touch the Safety icon on the Main Menu. The following screen will appear:

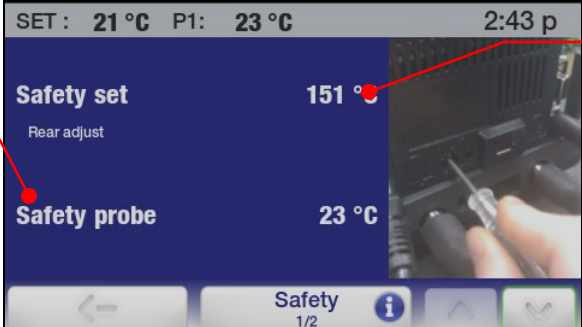

Displays the current safety probe reading.

Current safety set temperature.

See Controller Setup for information on changing this value

Touch ✓ to advance to the next page in the Safety sub-menu.

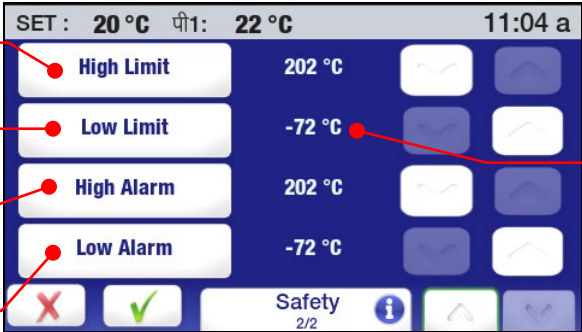

Highest allowable set point temperature

Lowest allowable set point temperature

Temperature above which unit will automatically shut down

Temperature below which unit will automatically shut down

Current setting; touch number to access numeric keypad

High Limit / Low Limit Temperatures — These values establish limits on how high or low the temperature set point may be set. To change, touch the up/down arrow icons. You can also change the limit value by touching the number itself; this will bring up a numeric keypad on which the desired limit temperature can be entered. Touch ✓ to accept the new setting, ✕ to cancel.

High Alarm / Low Alarm Temperatures — These values establish the maximum allowable temperature range for the unit. If the fluid temperature goes outside of this range, the system will shut down. To change, touch the up/down arrow icons. You can also change limit value by touching the number itself; this will bring up a numeric keypad on which the desired limit temperature can be entered. Touch ✓ to accept the new setting, ✕ to cancel.

Control

Touch the Control icon on the Main Menu. Page 1 of the Control sub-menu will appear:

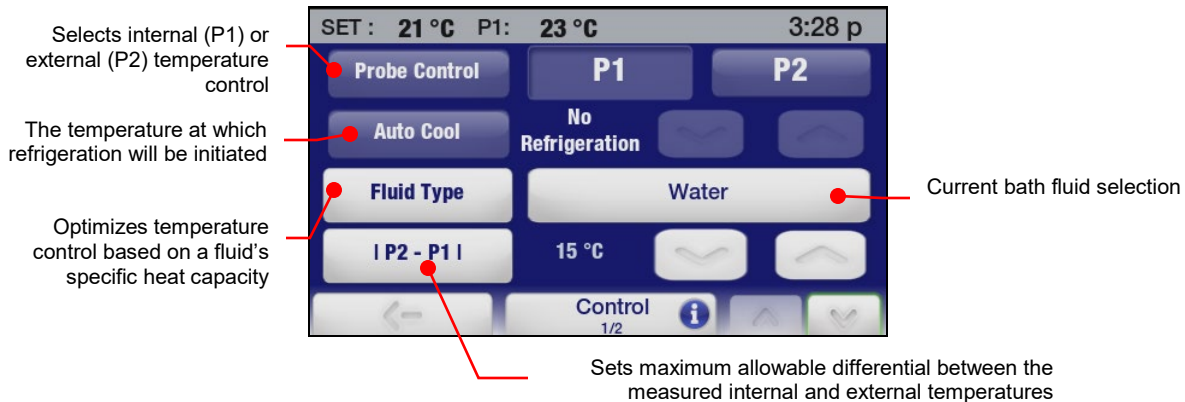

Probe Control — This establishes whether temperature control will be based on the fluid temperature within the Circulator's reservoir or the fluid temperature at an external device. Touch the P1 icon to select internal control; touch the P2 icon to select external control. Touch \checkmark to accept the new setting, \times to cancel.

	<p>NOTE: P2 can only be selected when a remote temperature probe is connected to the Temperature Controller.</p>
---	---

Auto Cool — This control setting functions only on refrigerated circulators. The setting determines the bath temperature at which refrigeration will be activated, permits more precise control when operating at high temperatures as well as more rapid cool downs. For most applications, a set point that is 15°C above room temperature is recommended. The Auto-Cool control range is from +2°C to 152°C.

To change, touch the up/down arrow icons. You can also change the auto cool temperature by touching the number itself; this will bring up a numeric keypad on which the desired value can be entered. Touch \checkmark to accept the new setting, \times to cancel.

Cool Command™ Refrigeration — -40°C 7 liter Refrigerating/Heating Circulators and 15 liter and larger Refrigerating/Heating Circulators feature the Cool Command™ modulating refrigeration control system. Cool Command allows the refrigeration system to turn on at a fluid temperature up to 152°C when the temperature set point is changed to or below the Auto-Refrigeration set point (152°C maximum). As a result, bath fluid cools more quickly.

Conventional Refrigeration — -20°C 7 liter Refrigerating/Heating Circulators use a conventional refrigeration system. The refrigeration system will turn on when the bath fluid temperature and set point are below the Auto-Refrigeration set point (70°C maximum).

Fluid Type — This sets the specific heat capacity (SHC) for the bath fluid being used to achieve optimal temperature control. Touch the Fluid Type or Current Bath Fluid icon to access a list of fluids; select custom from the list to manually enter the SHC. Touch ✓ to accept the new setting, ✕ to cancel.

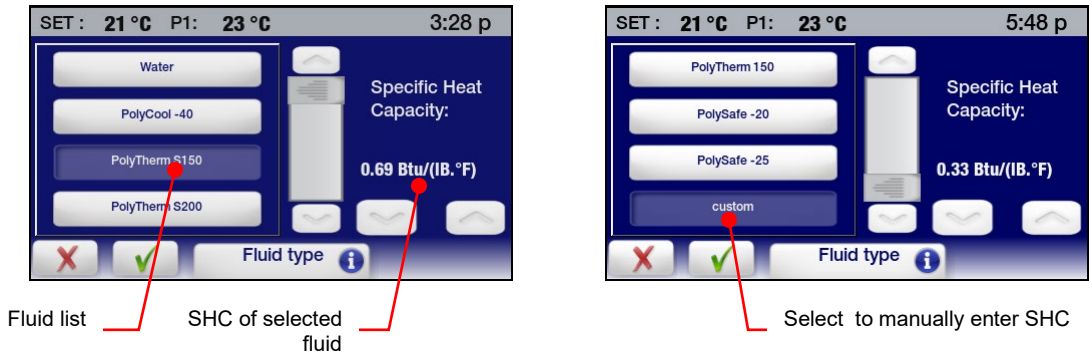

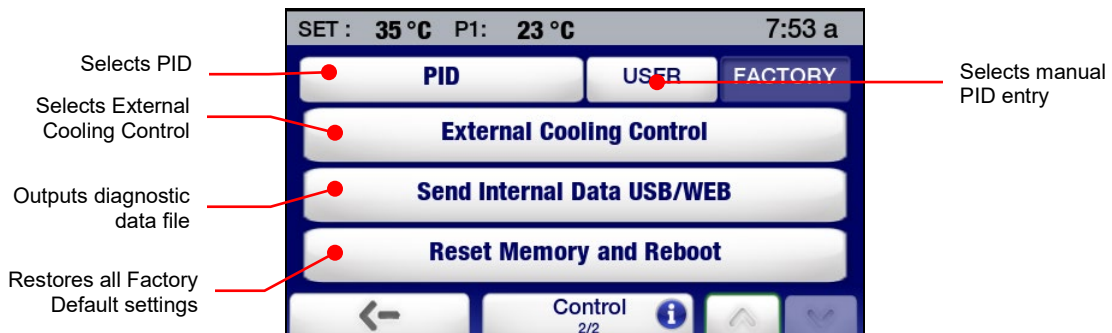

I P2 – P1 I — This setting is for use when external temperature control (P2) is being used. It establishes the maximum allowable differential between the external and internal measured temperatures and is intended to prevent uncontrolled heating or cooling should the external temperature probe be dislodged or fail. To change, touch the up/down arrow icons. You can also change displayed value by touching the number itself; this will bring up a numeric keypad on which the desired differential temperature can be entered. Touch ✓ to accept the new setting, ✕ to cancel.

Touch v to advance to page 2 in the Control sub-menu.

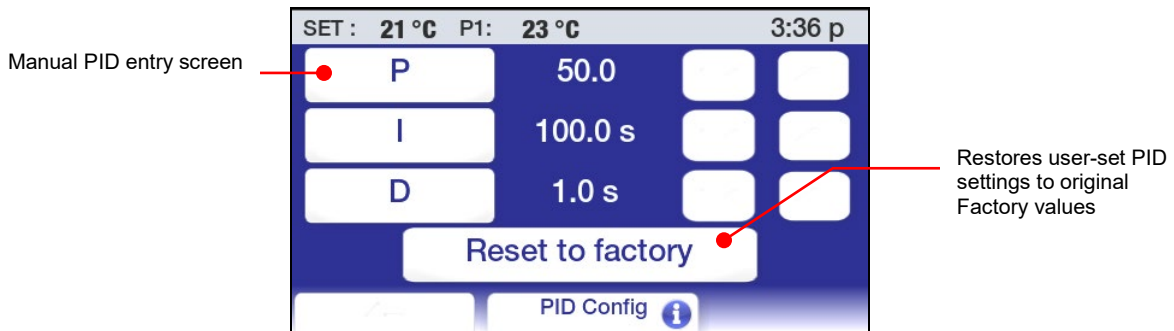

PID — This determines whether Factory or User-set PID settings will be used for temperature control. To manually enter PID values, touch the User icon and then use the increase and decrease icons to adjust the Proportional (P), Integral (I), and Derivative (D) settings to the desired values. Touch ✓ to accept the new settings, ✕ to cancel.



 **CAUTION:** The Advanced Programmable Temperature Controller's factory PID settings have been adjusted to achieve optimum temperature control. User-set PID values should only be used by individuals with a thorough knowledge and understanding of Proportional/Integral/Derivative control.

External Cooling Control — This feature is only functional on units fitted with the optional External Cooling solenoid valve. See *External Cooling Control* in the *Technical Information* section of this manual for more information.

Send Internal Data USB/WEB — This sends a diagnostic file to either a connected flash drive or web monitoring page. See *Diagnostic Data Logging* in the *Routine Maintenance & Troubleshooting* section of this manual for more information.

Reset Memory and Reboot — Restores Temperature Controller to all Factory default settings and values. See *Restoring All Factory Default Values*.

Communications and Data Logging

Touch the Connect icon on the Main Menu. The following screen will appear:



Configures Ethernet connection

Selects emulation mode for RS232 communications

Sets RS485 address via numeric keypad

Turns data logging ON and OFF

Ethernet — The Advanced Programmable Controller may be connected directly to a laptop or desktop computer via its Ethernet connection or indirectly via your facility's wired or wireless network. Either type of connection enables you to control and/or monitor the operation of your circulating bath in real time using an Internet browser by entering its IP address. The Controller's active serial communications commands are used to retrieve and/or change operational information. The Ethernet selection in the Connect sub-menu allows you to configure the IP address and subnet mask. When touched, the following screen is displayed:

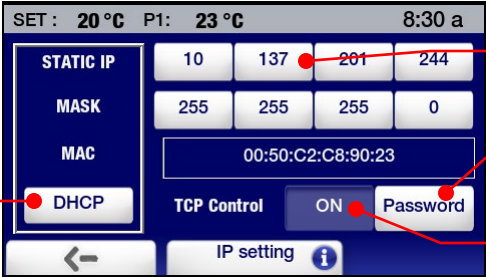

Selects dynamic entry of IP address

Allows manual entry of IP address via numeric keypad

Sets TCP password via alphanumeric keypad

Turns TCP Control password protection ON and OFF

When DHCP is selected, the following screen appears. It displays the dynamically assigned IP address.

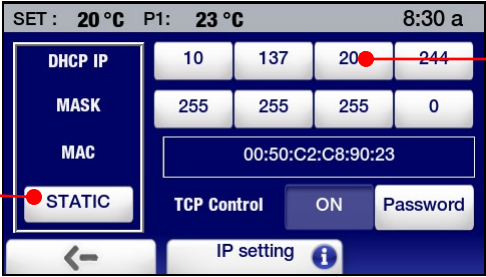

Selects manual entry of IP address

Displays dynamically assigned IP address



NOTE: See the *Technical Information* section for information regarding Ethernet configuration. See the *Advanced Operation* section for information on monitoring/controlling your Circulator using an internet browser.

RS232 — This is used to set the baud rate for RS232 bi-directional communications and, if desired, a communications protocol that emulates other common circulating baths. The increase and decrease icons are used to adjust the baud rate; you can also increase the baud rate by touching the displayed numerical value. Touch ✓ to accept the new settings, ✕ to cancel.

To select an RS232 communications protocol that emulates another circulator, touch the RS232 icon; the following screen will appear:

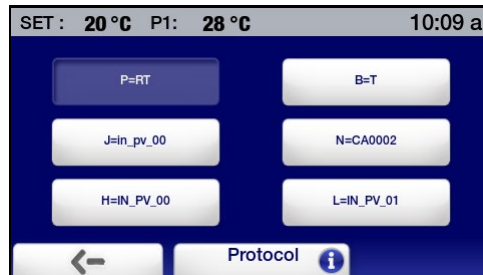

Touch the icon that represents the represents Read (or Get) Temperature command for the device. Touch ✓ to accept the new settings, ✕ to cancel.

USB — The Advanced Programmable Temperature Controller has both USB A and USB B ports. The USB A port is used for data logging; data is stored in a CSV file that can be read by spreadsheet programs such as Microsoft Excel®. To begin data logging, plug a flash drive into the USB A port and then touch the Logging icon to turn logging ON. Touch ✓ to accept, ✕ to cancel.



NOTE: See the *Technical Information* section for complete information regarding data logging file formats and content.

The USB B port can be used to monitor or control your Circulator using a personal computer. See the *Technical Information* section of this manual for more information.

RS485 — This is used to set the address for RS485 communications. The Temperature Controller supports cable lengths up to 1000 ft / 304.8 m. Use the increase and decrease icons to enter the desired RS485 address. You can also enter the address by touching the RS485 icon; this will bring up a numeric keypad on which the address can be entered. Touch ✓ to accept the entered address, ✕ to cancel.

Timer

Touch the Time icon on the Main Menu. The Time sub-menu will be displayed.

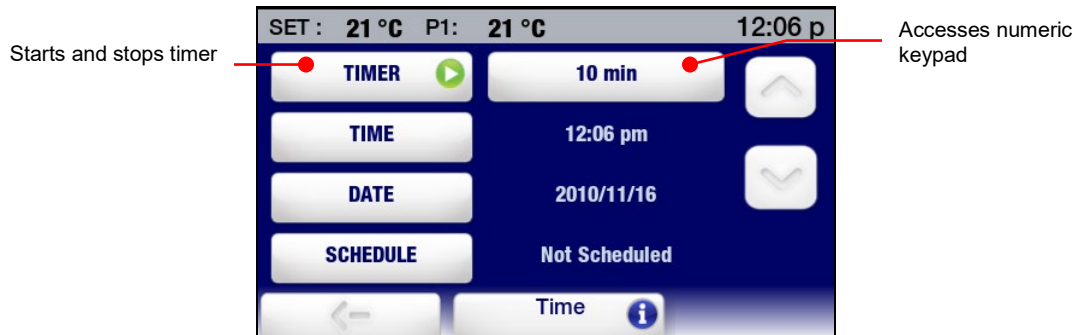

The Timer may be set from 0 to 999 minutes in one minute increments. Use the increase and decrease icons to change the displayed time or touch the Minutes icon to access a numeric keypad on which the desired interval can be entered.

To start the timer, touch the Timer icon. A clock icon and digital counter counting down the time (in minutes and seconds) will be displayed in the right corner of the status bar. Once it reaches 0:00, digital counter will turn red and begin counting up so you know how much time has elapsed since the end of the timed event.

Displays remaining time in black;

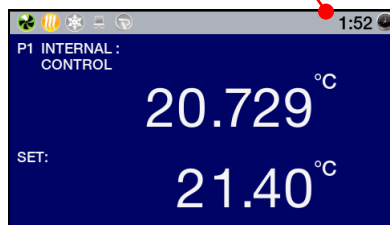

Displays elapsed time from end of event in red

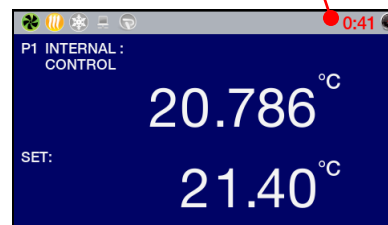

To stop or reset the timer, touch the Timer icon.



NOTE: See *Time and Date Settings* for information on selecting the time format (12 or 24 hour) and changing the time and date settings; see *Advanced Operation* for information on *Event Scheduling*.

Enabling / Disabling the Local Lock Out

Touch the Settings icon on the Main Menu. The Settings sub-menu will appear; Lock Out appears on page 2 of this sub-menu.

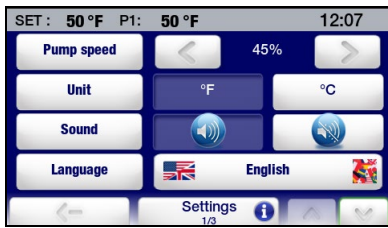

Selects Lock Out

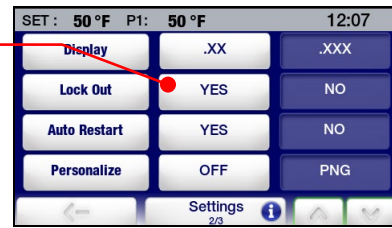

To enable Local Lock Out, touch YES. A password entry screen will appear:

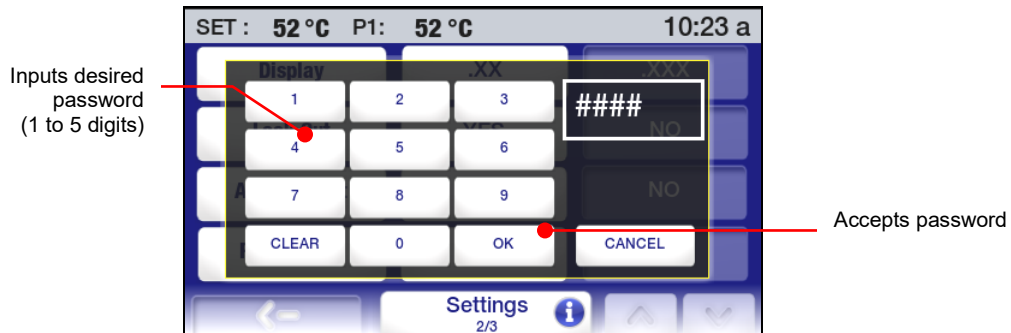

Enter any desired password from 1 to 5 digits in length and then touch the OK key. This both enables the Local Lockout and sets the password needed to disable the Local Lock Out.

When the Local Lock Out is enabled, a password entry screen will appear if the operator attempts to change the set point or access the Main Menu.



To disable the Local Lock Out, enter the password used to enable the lock out and touch OK. Access to the Main Menu and set point adjustment functions will now be permitted.



NOTE: The password used to enable the Local Lock Out is stored in memory only until it is used to disable the lock out. To re-enable the Local Lock Out, a new password (either the same password or a new one) must be entered via the Settings, Lock Out sub-menu.

Advanced Operation

Time/Temperature Programming

Creating a Time/Temperature Program

Press  to access the Main menu and then touch the Program icon. The Program sub-menu will appear:

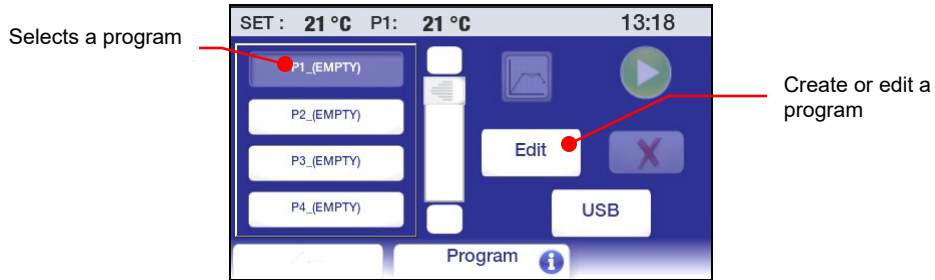

Initial Program Step — To set the parameters for the first step in your time/temperature program, touch a PX_(Empty) icon and then Edit. A screen for the first program step will appear:

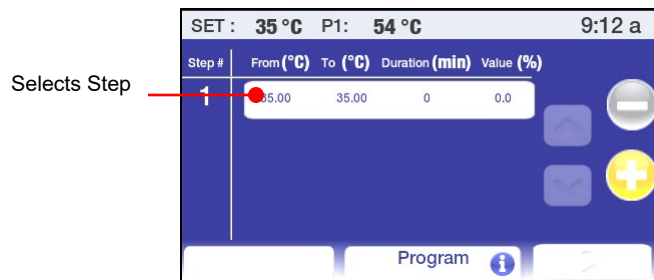

Touch the From / To icon. The screen for entering the Step Start Temperature, Step End Temperature, Step Duration (in minutes), and External Cooling will appear:

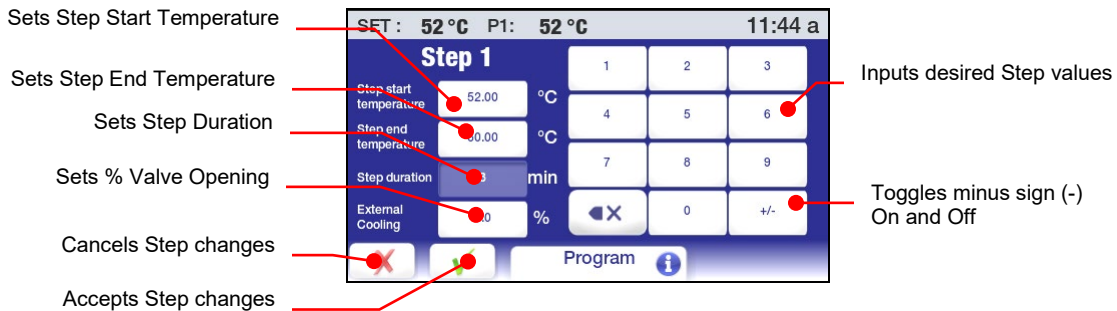

Step Start Temperature – This is the bath temperature at the beginning of the displayed Step. It is only settable for the initial step in the program.

Step End Temperature – This is the bath temperature desired at the end of the Step. It can be higher, lower, or the same as the Step Start Temperature depending on whether this is a ramp or soak step.

Step Duration – This is the amount of time desired to complete the Step. Enter 0 if you wish to ramp to the Step End Temperature as quickly as possible. Enter a higher value if you want to allow a more prolonged time to reach the Step End Temperature or if this is a soak step.

External Cooling -- This feature is only functional on units fitted with the optional External Cooling solenoid valve and affects the temperature ramp rate. The higher the % setting, the greater the flow of cooling water through the cooling coil. Valve opening is based on 5 second increments. If the External Cooling percentage is set at 20% and the Step Duration to 1 minute, the valve will be open for one second every five seconds spread evenly over the entire minute (i.e., open for 12 seconds). The cooling icon on the Status Bar will be lit whenever the External Cooling valve is open.

Enter Step Start and Step End temperatures, the Step Duration, and the External Cooling % by touching the associated icon and then using the keypad to enter the desired value. Touch \checkmark to accept the entered values, \times to cancel.



IMPORTANT: The initial Step Start temperature establishes the bath temperature that must be achieved before the Program will run. If the actual bath temperature is above or below the initial Step Start temperature, cooling (if the circulator is refrigerated) or heating will be applied to bring the bath to the Step Start temperature. Once that temperature has been achieved, the Program will begin running.

Additional Program Steps — Touch \oplus to add another program step. The “From” temperature value for each new step will default to the “End” temperature value from the previous step. Make changes to the Step End and Step Duration values as indicated previously.

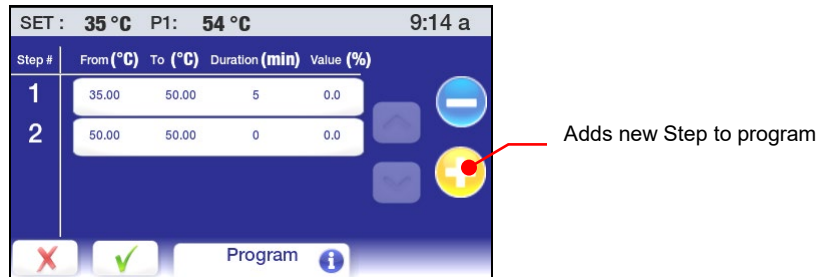

Step #	From (°C)	To (°C)	Duration (min)	Value (%)
1	35.00	50.00	5	0.0
2	50.00	50.00	0	0.0



NOTE: A Step Start temperature can only be entered for the first step in a program. All subsequent steps use the Step End value from the previous step as the Step Start value.

Naming and Setting Program Run Parameters — Touch \checkmark after you have entered all the steps you want in the program.



Step #	From (°C)	To (°C)	Duration (min)	Value (%)
1	29.00	32.00	5	0.0
2	32.00	32.00	5	0.0
3	32.00	35.00	5	0.0
4	35.00	29.00	7	0.0

A screen will appear that allows you to give your program a unique identifying name. There is an 8 character limit on a program name.

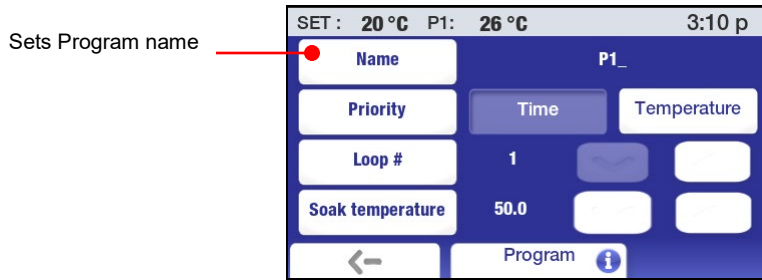

After you have named the program, you can set additional parameters for running the program

Priority – Programs may be run using either a Time- or Temperature-based priority. If achieving successive temperature set points is critical, Temperature should be selected as the priority. If completing a program in a fixed amount of time is essential, Time should be selected as the priority.

Loop – This is the number of times the program will run through the programmed steps; I.e., automatically begins running Step 1 once the final step in the program has been completed.

Soak Temperature – This is the temperature the bath should be maintained at once the final step has been completed.

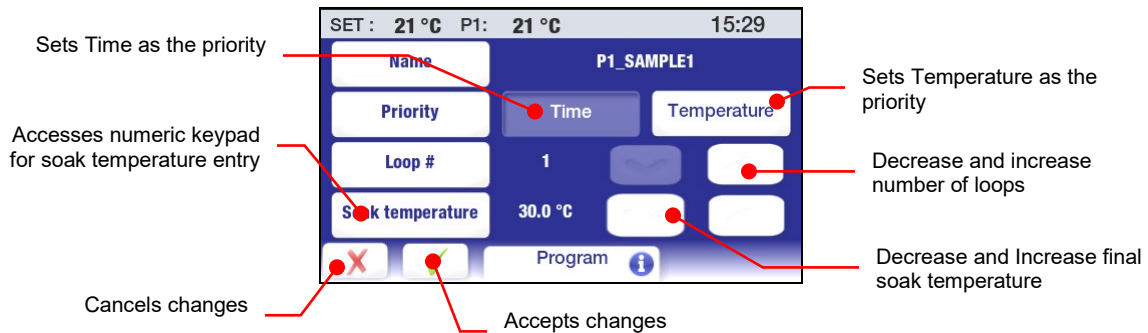

Previewing a Program

The Preview function enables you to review a recently created time/temperature program or verify that the program you want to run is the proper profile. This function is accessed by pressing , touching the Program icon on the Main Menu, and then selecting the program you wish to preview.

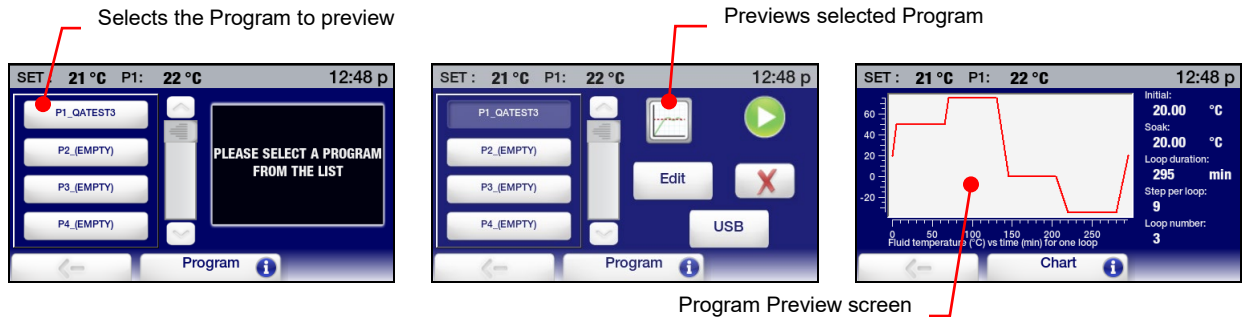

The Preview screen includes the following information:

Initial Temperature — This is the start temperature for Step 1.

Soak Temperature — This is the temperature at which the bath will be maintained upon completion of the program.

Loop Duration — This is the time (in minutes) it will take to complete one loop of the program.

Steps per Loop — This is the number of steps in the program.

Loop Number — This is the number of loops in the program

Fluid Temperature vs Time — This is a graphic representation of one program loop and illustrates ramp and soak times associated with various program steps.

Running a Program

Press  to access the Main menu and then touch the Program icon. The Program sub-menu will appear:

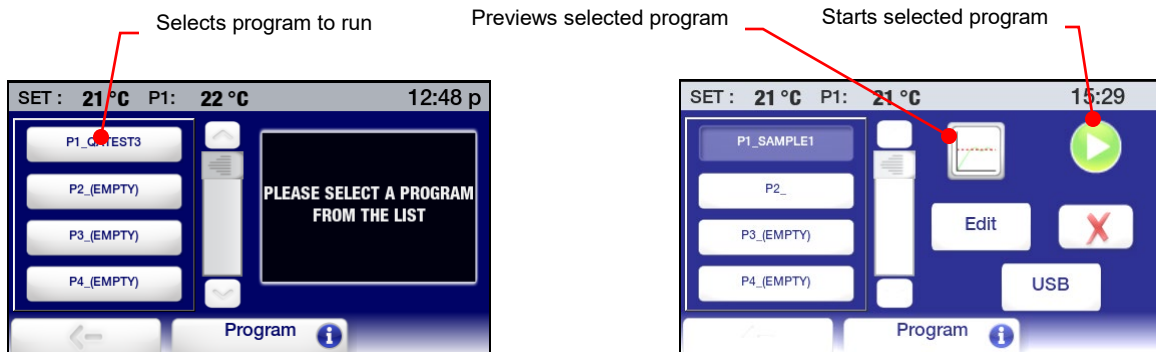

Select the Program you wish to run and then touch the Start icon to begin running.

	IMPORTANT: If the actual bath temperature is above or below the initial Step Start temperature, cooling (if the circulator is refrigerated) or heating will be applied to bring the bath to the Step Start temperature. Once that temperature has been achieved, the Program will begin running.
---	---

	NOTE: A program can also be scheduled to run automatically at a predetermined time and date. See <i>Event Scheduling</i> for more information.
---	---

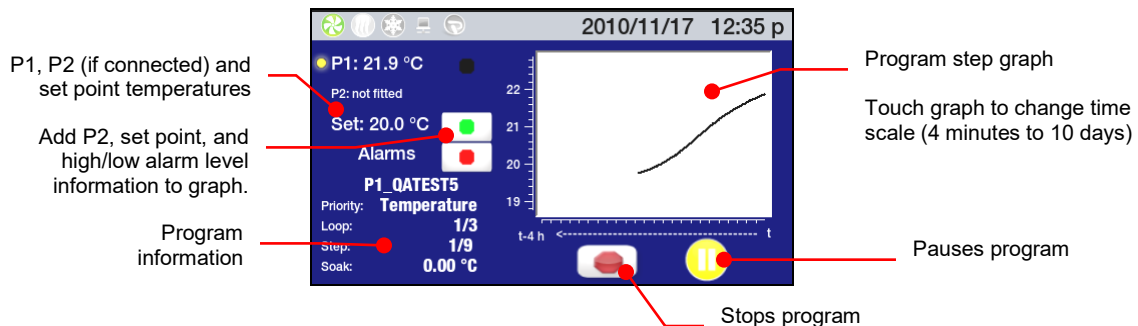

The Program Run screen includes the following:

Temperature Information — (P1) the actual bath temperature, (P2) fluid temperature as measured by the remote temperature sensor if connected and active, and (Set) the set point for the current temperature step.

Program Name — The name of the program that is running.

Program Information — The priority selected for the program (time or temperature), current and total number of loops, the current and total number of steps in the loop, the final soak temperature.

Temperature Graph — Actual (P1) bath temperature is always displayed. Touching the colored icons adds the following information to the graph: P2 temperature (blue); set point (green); high and low alarm levels (red).

	NOTE: When Alarm level information is displayed, the temperature scale on the graph expands to accommodate those temperature extremes and may cause set point and other temperature information to be displayed less clearly.
---	--

Time Scale — The time scale covered by the graph may be changed by simply touching an area within the graph. Temperature data can be displayed for periods ranging from the most recent 4 minutes to 10 days.

To temporarily stop a program, touch the Pause icon; the bath temperature will hold at the current temperature until restarted. Press the Start icon to resume. To permanently stop a program, press the Stop icon.



NOTE: A “paused” program can be restarted from the point it was paused (the Pause icon changes to a Start icon). A “stopped” program cannot be restarted.

Editing a Program

Press  to access the Main menu and then touch the Program icon. The Program sub-menu will appear:

Selects program to edit

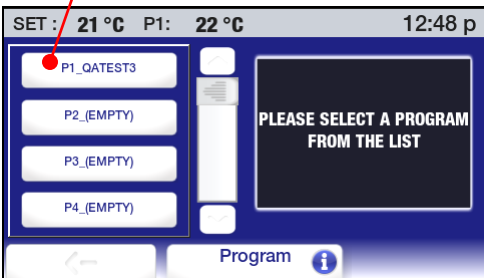

Edits selected program

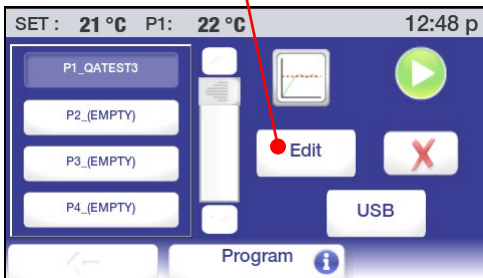

Select the Program you wish to edit and touch the Edit icon. The program screen for that program will appear, with the final program Step displayed.

Select to change Step End Temperature, Step Duration, or External Cooling % value

Final program Step

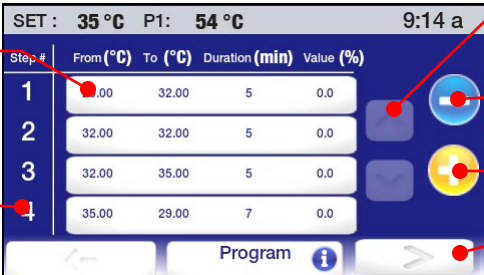





Moves up and down through Step list

Deletes final program Step



Add Step after final Step in program

Edits program parameters

Adding a Step —To add a Step to the program, touch ; a new Step will be added after the final Step in the program. Enter the Step End temperature and Step Duration by touching the associated icon and entering the desired values using the keypad. Touch  to accept the entered values,  to cancel.



NOTE: A Step can only be added to the end of a program.

Deleting a Step — To delete the final program Step, touch the minus (-) icon. Touch  to confirm the deletion,  to cancel.



NOTE: A Step can only be deleted from the end of a program.

Editing Step Parameters— To edit the Step End temperature, Step Duration, or External Cooling percentage value for a particular Step, touch the icon for that Step. The parameters for that Step will appear:



Select the parameter you wish to change and use the numeric keypad to enter the new value. Touch ✓ to accept, ✕ to cancel.

IMPORTANT: When the Step End temperature is changed, the Step Start temperature for the subsequent Step is automatically updated. However, the Step End temperature for the subsequent Step does not change. Depending on the change made, it may be necessary to change the temperature settings for all following Steps.

Editing Program Parameters — To change a program parameter, such as the priority or number of loops, touch the right arrow icon at the bottom right of the program steps screen. The program parameters screen will appear:

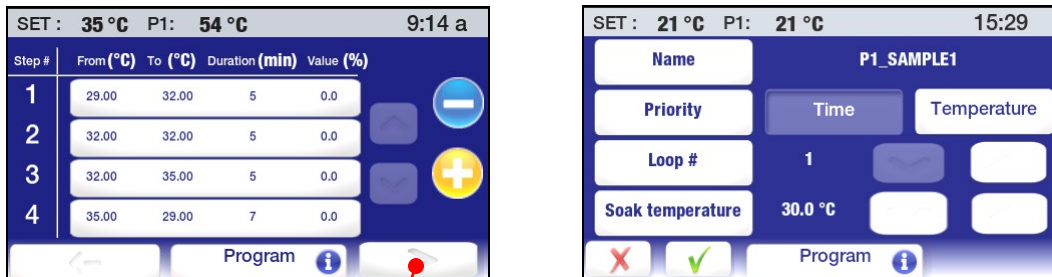

Accesses program parameters screen

You may change any or all program parameters, including the name of the program. Touch ✓ to accept the changes, ✕ to cancel.

Saving and Uploading Programs

This function allows you to save time/temperature programs to a flash drive or other external data storage device. The saved file can then be used to restore the original program or uploaded to other Advanced Programmable Temperature Controllers.

Saving a Program — Press  to access the Main menu and then touch the Program icon. The Program sub-menu will appear:



Touch any of the program icons; the program list screen will appear.

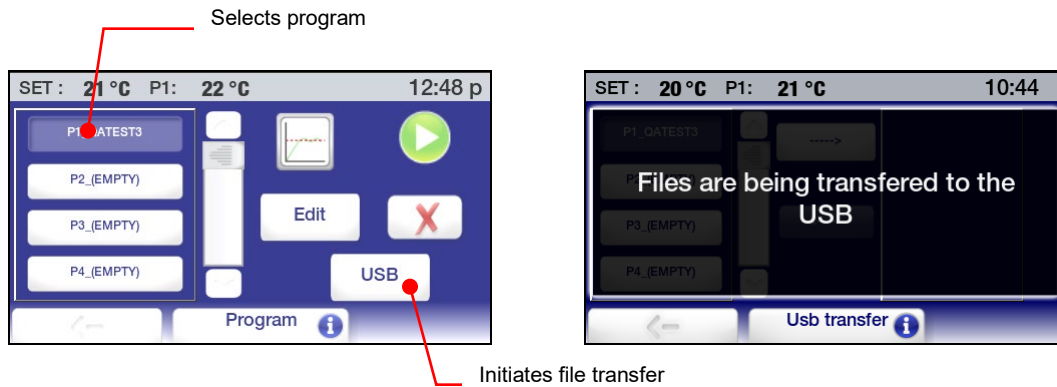

Select the program you wish to save and touch the USB icon. A message will briefly appear indicating that the file is being transferred to the USB followed by the file transfer screen.

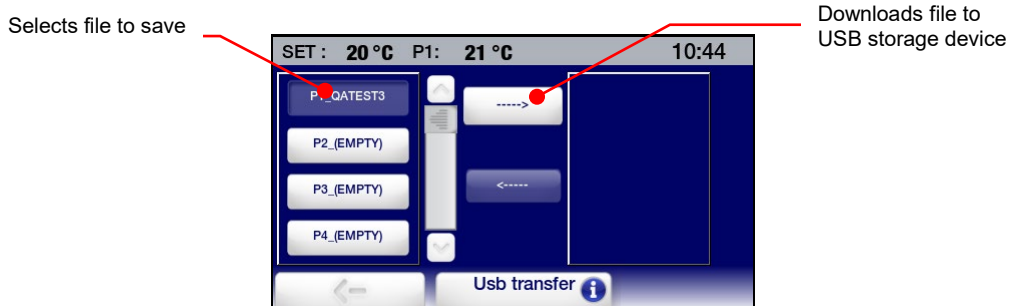

Select a file to transfer and touch the right arrow icon. Once the file transfer is complete, the file name will appear in the list box on the right of the screen.

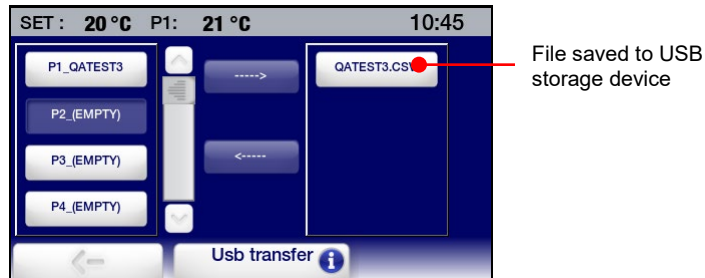

Uploading a Program — Press  to access the Main menu and then touch the Program icon. The Program sub-menu will appear:



Touch any of the program icons; the program list screen will appear.

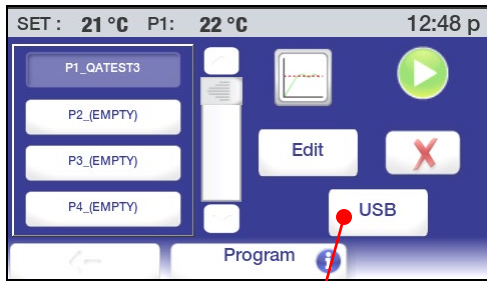

Initiates upload



Select a location for the program you wish to upload and touch the USB icon. A message will briefly appear indicating that the file is being transferred from the USB followed by the file transfer screen.

Select the destination for the upload, select the program you wish to upload, and then touch the left arrow icon.

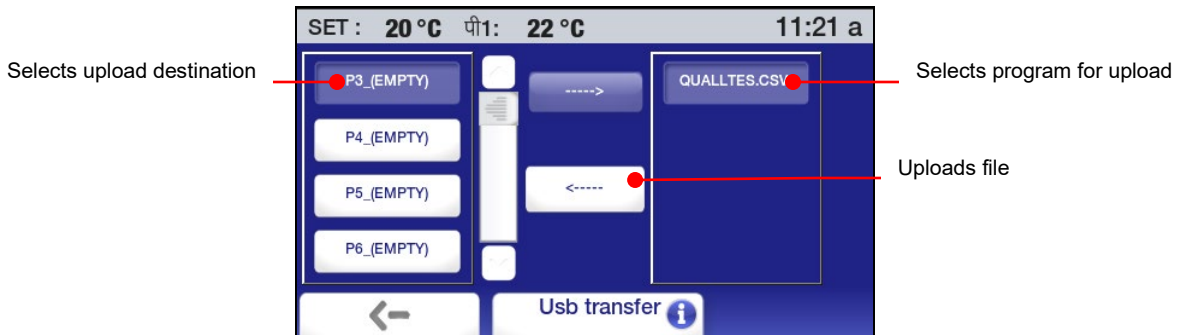

Once the file transfer is complete, the program name will appear on the program list.



Event Scheduling



IMPORTANT: You must place the Circulator in Standby in order for a scheduled event to run.

This function allows you to schedule a time/temperature program to begin running automatically at a predetermined time and date. The Circulator must be Off (in Standby); it will turn On automatically and begin running the program at the scheduled time.

To schedule such an event, press  to access the Main menu and then touch the Time icon. The Time sub-menu will appear:

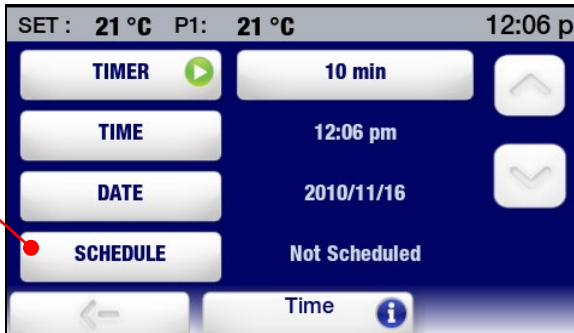

Schedules a time/temperature program to run at a future time

Touch the Schedule icon. The scheduling screen will appear:

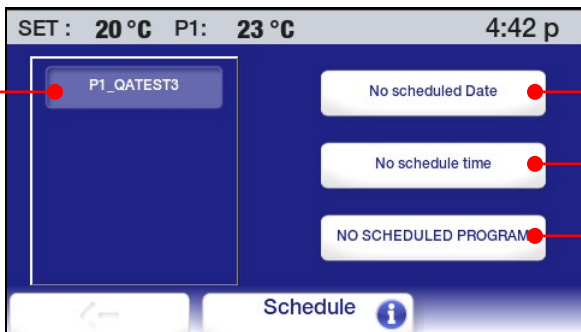

Selects a program to schedule

Schedules the Start date

Schedules the Start time

Deletes scheduling information

Selecting a Program — Touch the icon associated with the program you wish to schedule.

Entering the Start Date — Touch the Date icon. A calendar screen will appear.

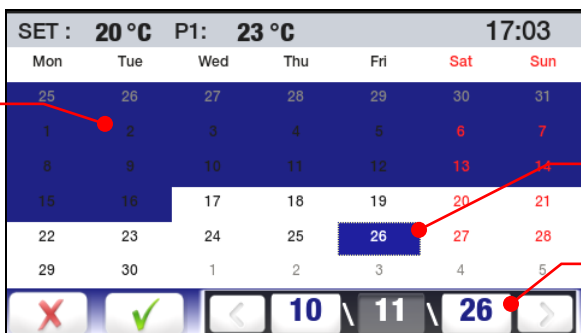

These are dates in the past and cannot be selected;

Selects a specific day in the displayed month

Touch to change year, month, or day using up and down arrow icons

Enter the Start date for the program: year, month, and date you want the program to start on. Touch ✓ to accept the scheduled Start date, ✕ to cancel.

Entering the Start Time — Touch the Time icon. A time entry screen will appear:

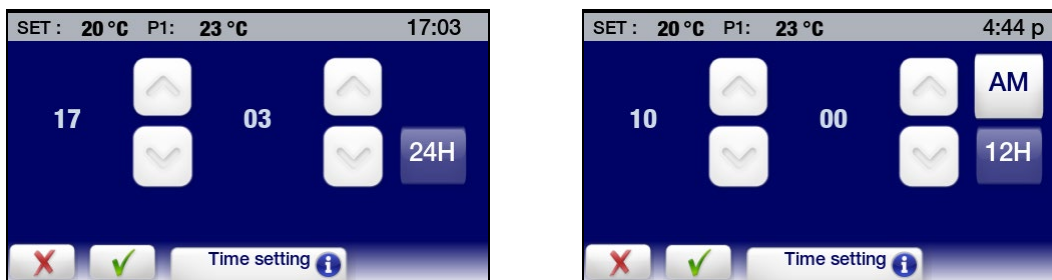

Enter the Start time for program. Touch ✓ to accept the scheduled Start time, X to cancel. A screen will appear showing the date and time at which the program is scheduled to run.

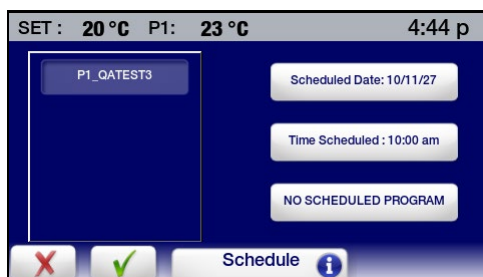

Deleting a Scheduled Event — To delete a scheduled program, select that program and then touch the No Scheduled Program icon. Scheduling information for that event will be cleared.

Scheduled Event Reminder – When a program has been scheduled to run at a future date and time, the Program/Event icon on the Status Bar illuminates.

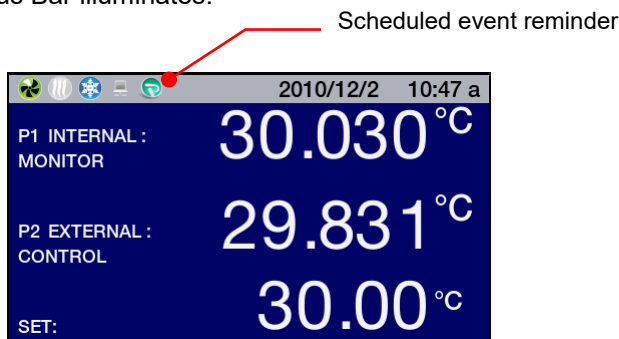

When power is turned OFF, a reminder appears on the Standby screen.

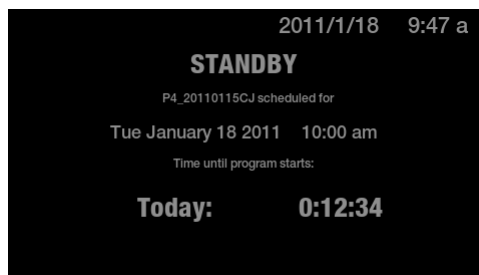

Creating and Installing a Personalized Home Screen

The Advanced Programmable Controller features a special home page that you can easily personalize with a special message, favorite photo, or other image. Following is an example of a personalized home screen:

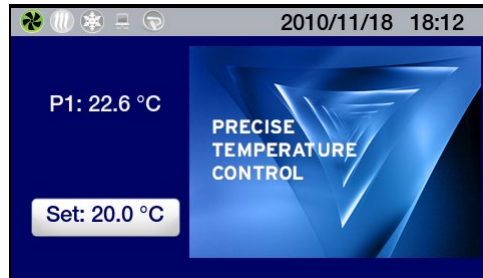

Creating the Image — The personalized home screen requires a 291 x 211 pixel Portable Network Graphic (PNG) file. The file should be saved to a flash drive and named: PSC.png (be sure to use all uppercase letters for PSC).

Installing the Image — Place the flash drive containing the PSC.png file in the USB A port. Press  to access the Main menu and then touch the Settings icon. The Settings sub-menu will appear:



Touch  to advance to page 2 of the Settings sub-menu.



Touch the PNG icon to turn personalization ON and then touch . The Main Menu screen will appear. Your image will now be displayed on the personalized home screen.



NOTE: Wait at least 30 seconds after turning personalization on before removing the flash drive from the USB port.

Circulator Monitoring and Control Using an Internet Browser

NOTE: The Advanced Programmable Controller's Ethernet capabilities may be used with any of the following web browsers: Internet Explorer 9.0 or later, Firefox, Chrome, Safari, or Opera.

NOTE: A user-set password is required if you want to control (change set point, etc.) your Circulator using an internet browser. A password is not required if all you want to do is view operation. See *TCP Control Configuration* in this section for information on password setup.

The Advanced Programmable Controller may be connected directly to a laptop or desktop computer via its Ethernet connection or indirectly via your facility's wired or wireless network. Either type of connection enables you to control and/or monitor the operation of your circulating bath in real time using an Internet browser by entering its IP address. See *Ethernet Configuration* in the *Technical Information* section for information on IP address and TCP control configuration.

To view Circulator status using an internet browser, enter its IP address in the browser address bar. A screen will appear with the following information and interactive fields:

The screenshot shows the 'PRECISE TEMPERATURE CONTROL' web interface. It features a central data table, a temperature trend graph, and a command entry section. Red lines with labels point to various elements:

- Set point temperature:** Points to the 'Set Point: 47.00 °C' value.
- P1 internal temperature reading:** Points to the 'P1 Internal Bath Control: 39.444 °C' value.
- P2 external temperature reading:** Points to the 'P2 External Probe: 38.559 °C' value.
- Login for TCP control (password required):** Points to the 'Login required to change settings' text.
- Serial command entry:** Points to the 'Enter a Command' input field.
- Setting / value field:** Points to the dropdown menu next to the command input.
- Temperature trend graph:** Points to the line graph showing temperature over time.
- Scales from 4 minutes to 10 days:** Points to the 'Graph Scale' legend.

The data table in the interface is as follows:

Parameter	Value
Set Point:	47.00 °C
P1 Internal Bath Control:	39.444 °C
P2 External Probe:	38.559 °C

The graph shows temperature trends for Set (green), P1 (blue), and P2 (purple) over time. The y-axis ranges from 31.7°C to 52.0°C. The x-axis is labeled 'Seconds'.

The 'Graph Scale' legend includes the following options:

- Interval: 4 minutes, scale: 10-seconds
- Interval: 40 minutes, scale: 1-minute
- Interval: 4 hours, scale: 10-min

Calibration



CAUTION: The maximum calibration offset for any given temperature point is $\pm 2.0^{\circ}\text{C}$. When calibrating at 2 or more temperature points, there must be at least a 50°C span between the lowest calibration temperature and the highest calibration temperature. Calibrations are always performed in degrees C.

The Advanced Programmable Temperature Controller features 10-point calibration capability for both the internal and optional external temperature probes. To access the Calibration function, touch the Service icon on the Main Menu and then advance to page 2 of the Service sub-menu.

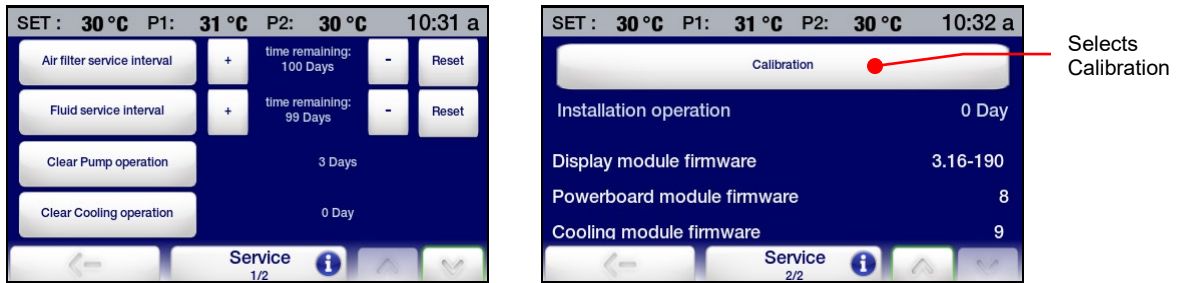

Touch the Calibration key. The following screen will appear:

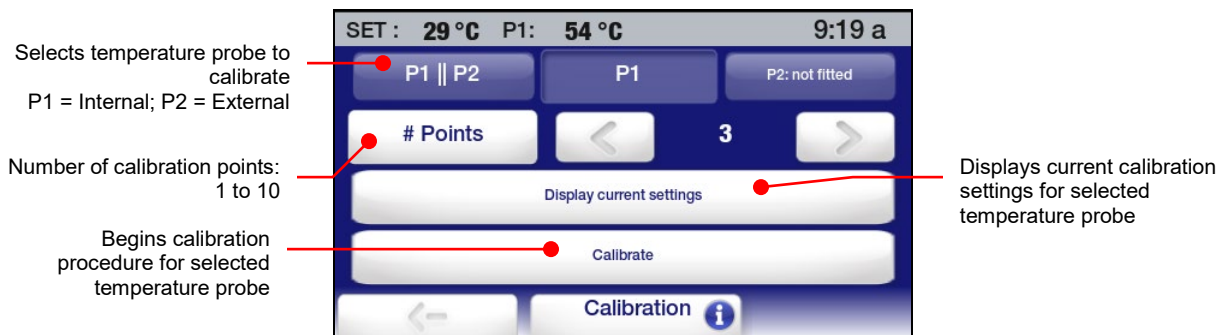

Select the temperature probe to calibrate, enter the number of calibration points (1 to 10), and then touch the Calibrate key. A password entry screen will appear:

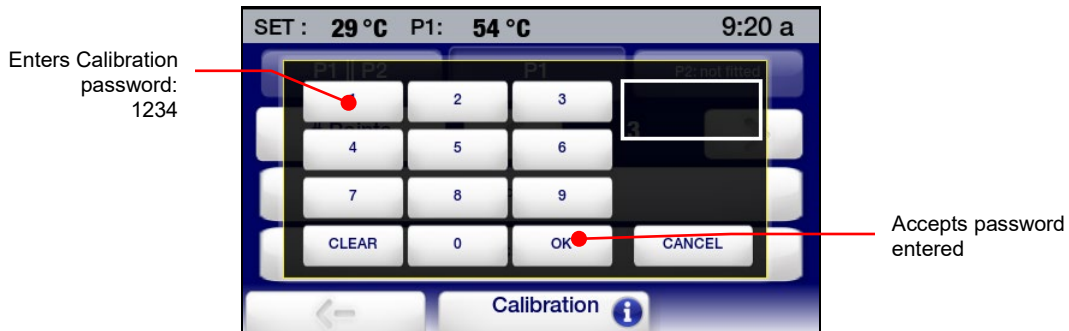

Enter the Calibration password (1234) and touch OK. The following screen will appear:

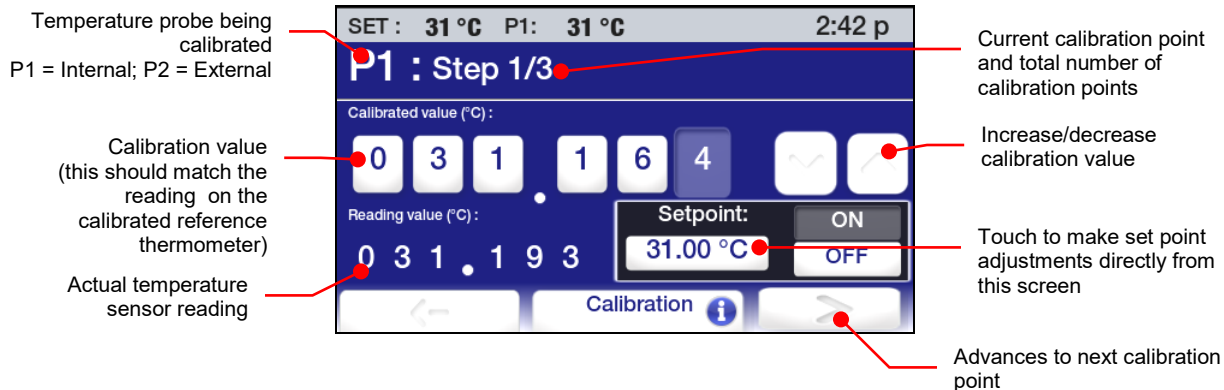

Proceed as follows:

1. Place the calibrated reference thermometer in the bath at the location to be calibrated.
2. Enter the set point temperature for the calibration point and allow the bath to stabilize at that temperature.
3. Enter the reading from the calibrated reference thermometer. An offset up to $\pm 2.0^{\circ}\text{C}$ is allowed.
4. Press the > key. The calibration screen for the next calibration point will appear.
5. Proceed as outlined in steps 2 through 4 above until all calibration points have been entered. Be sure to allow the bath to stabilize at the new set point temperature before entering the calibration value for each point.
6. Once all the calibration points have been entered, touch the > key. The following screen will appear:

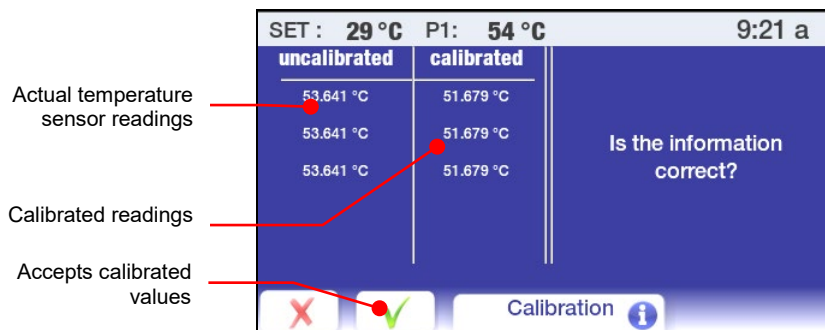

Restoring All Factory Default Values



CAUTION: All time/temperature programs, calibrations, and other user-set values are erased when Factory default values are restored. Be sure to save any programs you wish to keep to a flash drive and record any settings that you have changed.

Touch the Control icon on the Main Menu and then advance to page 2 of the Control sub-menu:

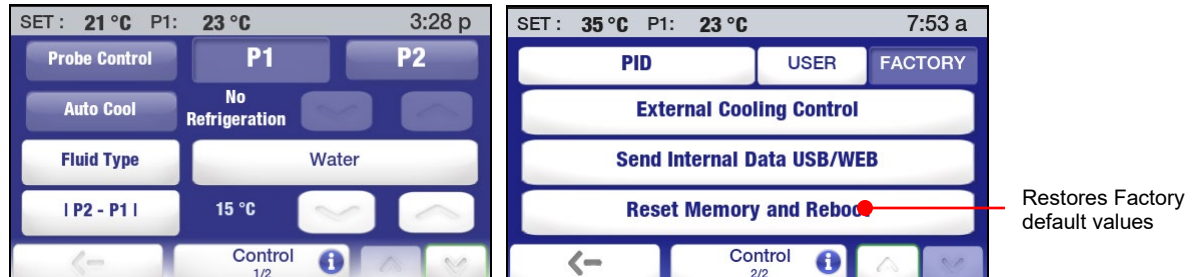

Touch the Reset Memory and Reboot key. A password entry screen will appear:

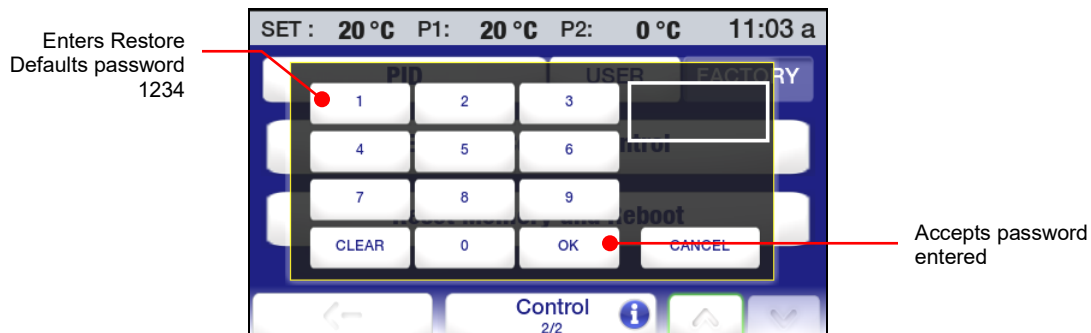

Enter the Restore Defaults password (1234) and touch OK. The Temperature Controller will power down and then reboot in Standby.

System Restoration



CAUTION: All firmware updates made will be lost when a system restoration is performed. All operational settings will also be returned to the original factory defaults. Be sure to save any programs you wish to keep to a flash drive and record any settings that you have changed.

Should you need to restore the Advanced Programmable Controller to its original factory configuration (firmware as well as all default operational settings), you may do so using its built-in system restoration utility. System restoration is performed as follows:

1. Turn power to the Controller OFF by pressing the Power Key on the front of the Controller.
2. Place the Power Switch/Circuit Breaker on the rear of the unit in the OFF position.
3. Return the Power Switch/Circuit Breaker to the ON position while pressing and holding the Home Key. Continue holding the Home Key until the touch screen calibration screen appears.
4. Follow the calibration instructions on the screen. Once you complete the touch screen calibration procedure, the hour glass image will briefly reappear and followed by the Standby screen.
5. Press the Power Key to return to normal operation.

Changing Your Circulator's Viewing Angle

Your Circulator is equipped with Swivel 180™, an innovative feature which permits viewing of the temperature display from anywhere over a 180° arc.



NOTE: There are positive stops at 45° intervals; however, the viewing angle may be set anywhere within a 180° arc.

To change the viewing angle, slide the release latch to the right and rotate the Temperature Controller to the desired angle. The latch release will automatically return to the locked position at every 45° positive stop.

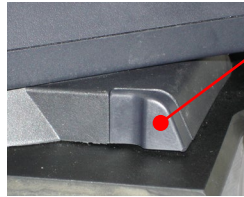

Swivel 180™ Latch Release

Inert Gas Purge

A 0.125 in. / 3 mm port on the rear of the Temperature Controller is provided to allow you to blanket the surface of the liquid in the bath reservoir with nitrogen or another inert gas to help prevent condensation and dilution of the bath fluid.

Tap Water Cooling

Tap water cooling allows for more rapid bath cool down from high temperatures and/or more precise operation at temperatures near ambient.

Heat only Circulating Baths feature an integrated cooling coil as standard equipment. The tap water connections are made on the rear of the unit. Two 0.25 inch / 64 mm female NPT fittings are provided for these connections.

Polycarbonate Viscosity Baths feature a cooling coil with two 0.375 inch / 9.5 mm OD straight barb fittings at which the fluid inlet and outlet connections can be made. Either connection may serve as the fluid inlet or outlet. Be sure to secure the tubing with the appropriate size hose clamps.

An optional cooling coil is available for use on stainless steel and polycarbonate Open Bath systems. This cooling coil has two 0.375 inch / 9.5 mm OD straight barb fittings at which the fluid inlet and outlet connections can be made. Either connection may serve as the fluid inlet or outlet. Be sure to secure the tubing with the appropriate size hose clamps.



WARNING: The fluid outlet must be connected and flow to a suitable drain or vessel located at a level below that of the inlet.

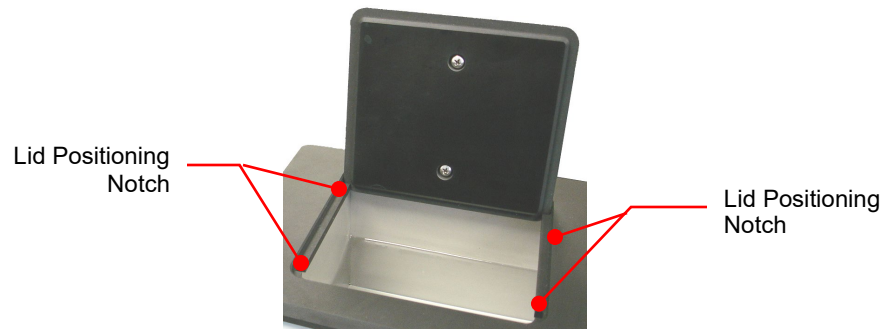

Reservoir Cover Storage

Refrigerating/Heating and Heat Only Circulating Baths feature the LidDock® system to eliminate mess when adding fluid or samples to the reservoir. Specially positioned notches in the inner lip of the top deck allow you to stand the reservoir cover up upright over the bath opening, allowing condensate to flow back into the bath.



NOTE: 75 liter Refrigerating/Heating Baths and Calibration Baths are not equipped with LidDock®.

Routine Maintenance & Troubleshooting

	<p>WARNING: Always turn your Circulator OFF and disconnect it from the electrical power outlet before performing any maintenance or service.</p>
	<p>WARNING: To avoid the potential for burns, allow the Circulator to cool completely before cleaning or performing any maintenance.</p>
	<p>WARNING: Always drain all fluid from the reservoir before moving or lifting your Circulator. Be sure to follow your organization's procedures and practices regarding the safe lifting and relocation of heavy objects.</p>

Service Sub-Menu

This sub-menu contains important information regarding the operation of your Circulator, such as the number of days the unit and key systems have been in service as well as the number of days until air filter and fluid maintenance is required.

Press  to access the Main menu. Touch the Service icon to access the Service sub-menu.

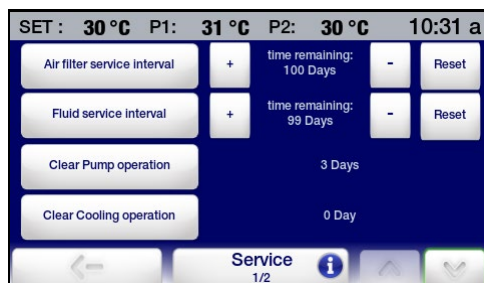

Page 1

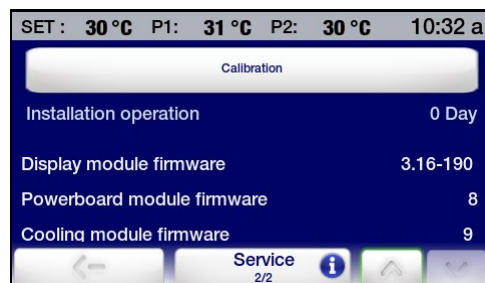

Page 2

Air Filter Service Interval — This allows you to view the number of days remaining until air filter cleaning is required and set a service interval for this maintenance (10 to 180 days). This function is active only on Refrigerating/Heating Circulators.

Touch the + and – icons to increase and decrease the service interval; Reset returns the time remaining to 180 days.

Fluid Service Interval — This allows you to view the number of days remaining until bath fluid replacement is required and set a service interval for this maintenance (10 to 180 days).

Touch the + and – icons to increase and decrease the service interval; Reset returns the time remaining to 180 days.

Clear Pump Operation — This allows you to view the length of time the pump has been operating. Touch Clear Pump operation to reset it to 0.

Clear Cooling Operation — This allows you to view the length of time the cooling system has been operating. Touch Clear Cooling operation to reset it to 0.

Calibration — This allows you to calibrate the Temperature Controller. See the *Calibration* section of this manual for more information.

Installation Operation — The length of time the Circulator has been operating.

Display Module Firmware — The version of the currently installed display module firmware.

Power Module Firmware — The version of the currently installed power module firmware.

Cooling Module Firmware — The version of the currently installed cooling module firmware.

Diagnostic Data Logging

This feature enables you to log key operational information that can be used by a service technician to evaluate performance and diagnose problems. Logged data represents the Circulator's performance at a moment in time. The name of the file created is: TFTINFO.xml.

Data may be logged to a flash drive inserted in the USB A port.

1. Place a flash drive in the temperature controller's USB A port.
2. Go to the second page of the Control sub-menu and select "Send Internal Data USB/WEB".

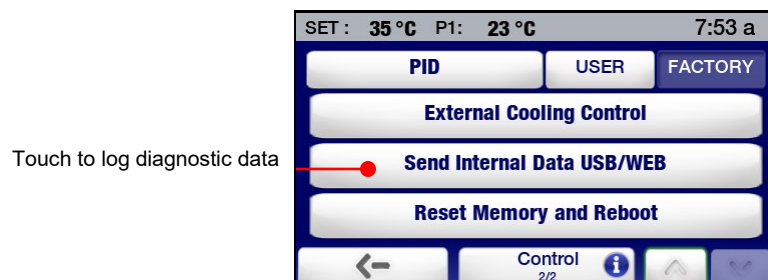

3. Remove the flash drive from the USB A port.

Maintaining Clear Bath Water

Optimum temperature and moisture conditions for algae growth exist when using water as a bath fluid. To prevent algae contamination and minimize the frequency of draining the reservoir, an algaecide such as Polyclean Bath Algaecide (004-300040) should be used.



WARNING: Do not use chlorine bleach.

Draining the Bath Reservoir



WARNING: Always drain all fluid from the reservoir before moving or lifting your Circulator. Be sure to follow your organization's procedures and practices regarding the safe lifting and relocation of heavy objects.



WARNING: Bath fluids should be stored and disposed of according to applicable laws and regulations.

Refrigerated / Heating and Heat only Circulating Baths

Refrigerated / Heating and Heat only Circulating Baths are equipped with a drain valve and port located either beneath the front access panel or on the right hand side of the unit.

To drain fluid from the bath, attach a short length of suitable 0.45 inch / 11.5 mm ID tubing to the drain port and secure it using a hose clamp with a minimum ID of 0.7 inch / 18 mm. Open the drain valve using a flat blade screwdriver. When closing the valve, do not over tighten.



WARNING: Be sure to close the drain valve before refilling the bath reservoir. Do not over tighten.

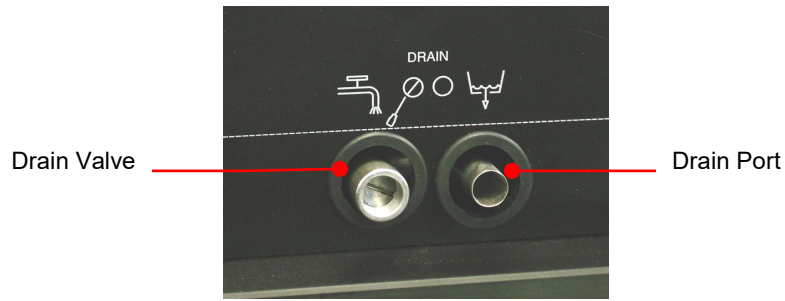

Checking the Over-Temperature / Low Liquid Level Safety Systems

Your Circulator incorporates over-temperature and low liquid level protection according to IEC 61010-2-010. For optimum safety, these systems should be checked at least every six months for proper operation. These checks must be performed with the unit running.

Over-Temperature Protection

1. Press  to access the Main menu.



2. Touch the Safety icon to access the Safety sub-menu.

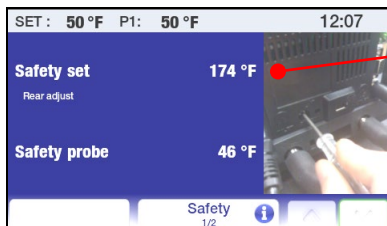

Safety Set Temperature

3. Using a small, Philips head screwdriver, rotate the Safety Set Thermostat on the rear of the Temperature Controller until the unit shuts down. The Safety Set temperature at this point should be the same as the actual bath temperature.
4. Return the Safety Set temperature to the desired over-temperature value.
5. Press the  key to return to the Main Operational Display.

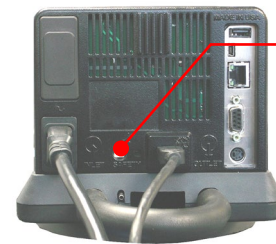

Safety Set Thermostat



Low Liquid-Level Protection

1. Set the temperature set point to ambient and allow the Circulator to stabilize at that temperature.
2. Increase the temperature set point to about 5°C above ambient and slowly drain fluid from the bath.
3. Continue draining fluid until the unit shuts down. The fluid level at this point should be approximately 3.0 inch / 7.6 cm below the underside of the Circulator's top deck.
4. Replace the bath fluid and return to normal operation.

Cleaning Your Circulator



WARNING: It is the user's responsibility to properly decontaminate the unit in the event hazardous materials are spilled on exterior or interior surfaces. Consult the manufacturer if there is any doubt regarding the compatibility of decontamination or cleaning agents.

Temperature Controller

Turn the Temperature Controller OFF by pressing  and unplug power cord from the electrical outlet.

Wipe the housing with a clean cloth dampened with a mild detergent and water or mild all-purpose cleaner.



CAUTION: Do not spray cleaning liquids directly onto the Temperature Controller or allow them to enter the Controller's vents. Do not use abrasives as these could scratch the housing or the digital display.

Bath Reservoir

Bath Reservoir and Wetted Components — A concentrated bath cleaner (polyclean Bath Cleaner, part number 004-300050) is available to remove mineral deposits from the stainless steel reservoir and the Temperature Controller's wetted parts. The cleaner should be added to the bath reservoir at the prescribed dosage and circulated at 60°C / 140°F until the scale is removed.



CAUTION: Do not use steel wool to clean your Circulator's bath reservoir.

External Surfaces

Only mild detergents and water or an approved cleaner should be used on the top deck and other external surfaces of your Circulator. Do not allow cleaning liquids or sprays to enter the vents on the rear of the Temperature Controller.

Pump Impeller

In the unlikely event that debris becomes lodged in the pump impeller, a soft brush can be used to remove any lodged particles. If necessary, soak in a solution of distilled water and polyclean Bath Cleaner to soften before brushing.



CAUTION: Do not use hard utensils or abrasive pads to remove trapped debris.

Condenser, Air Vents, and Reusable Filter (Refrigerating / Heating Circulators only)

To keep the refrigeration system operating at optimum cooling capacity, the condenser, removable air filter, and all air vents (front, side, back) should be kept free of dust and dirt. Be sure to check them on a regular basis and clean as required.

The reusable filter is easily accessed from the front of the unit by simply removing the access panel. Use a mild detergent and water solution to wash off any accumulated dust and dirt. Rinse and dry thoroughly before reinstalling.

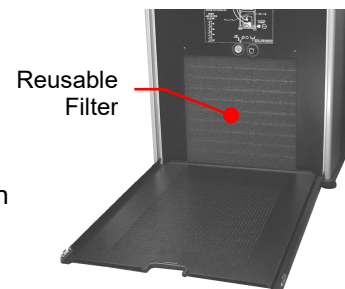

Temperature Controller Removal and Re-Installation

Removal

The Temperature Controller on your Circulating Bath is designed to be easily removed from the top deck without the use of special tools. It is removed as follows:

1. Place the tip of a small flat blade screwdriver under the retaining ring locking tab and pry up gently.

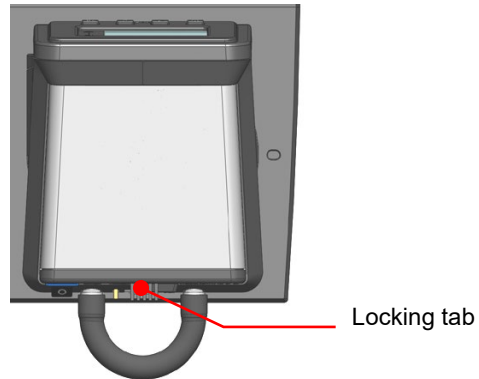

2. Rotate the Temperature Controller clockwise until it stops (about 0.75 inch / 1.9 cm).



3. Lift the Controller straight up and out of the opening of the Circulator's top deck.

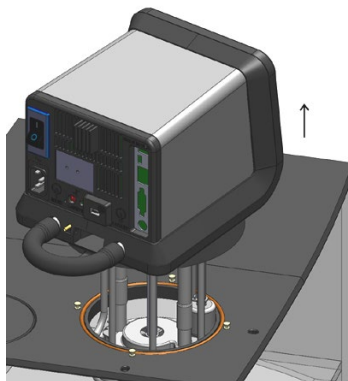

Re-Installation

The top deck of your Circulator incorporates four pins to facilitate positioning of the Temperature Controller when it is being reinstalled. These pins correspond to keyhole slots on the interior of the Circulator's retaining ring.

1. With the retaining ring locking tab oriented above one of the indents on the top deck, slowly lower the Temperature Controller into the top deck opening until it is resting on top of the positioning pins.

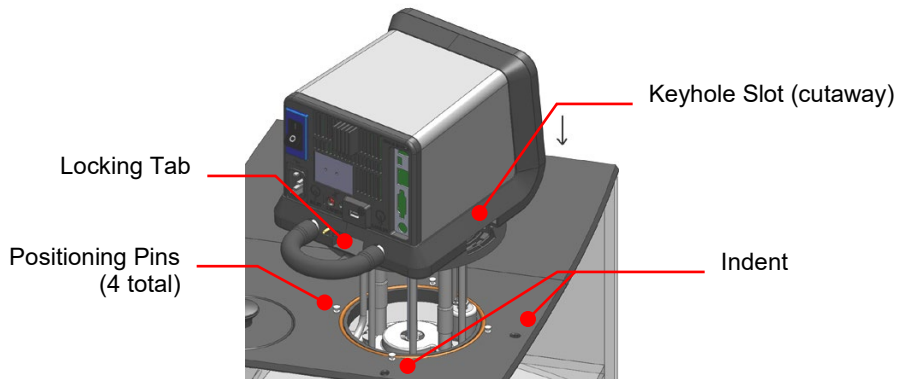

2. Gently rotate the Temperature Controller until it drops down on the positioning pins.

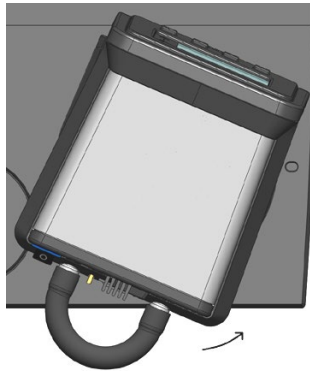

3. Rotate the Temperature Controller counterclockwise until the Locking Tab engages the indent on the top deck.

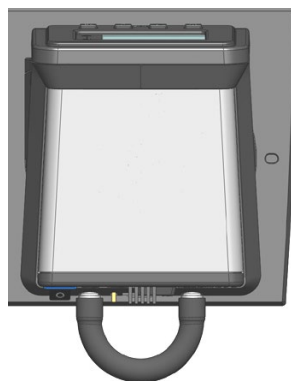

Calibrating the Touch Screen

The Advanced Programmable Controller has a built-in feature that allows you to calibrate the touch screen so that it responds more accurately to your touch. This calibration is performed as follows:

1. Turn power to the Controller OFF by pressing the Power Key on the front of the Controller.
2. Place the Power Switch/Circuit Breaker on the rear of the unit in the OFF position.
3. Return the Power Switch/Circuit Breaker to the ON position. An hour glass image will appear on the display.
4. When the hour glass image fades away, press and hold the Home Key until the calibration screen appears.
5. Follow the calibration instructions on the screen. Once you complete the touch screen calibration procedure, the hour glass image will briefly reappear and followed by the Standby screen.
6. Press the Power Key to return to normal operation.

Display Module Firmware Updates



CAUTION: The current version of firmware as well as all time/temperature programs, calibrations, and other user-set values are erased when new Display Module Firmware is installed. Be sure to save any programs you wish to keep to a flash drive and record any settings that you have changed.

The Advanced Programmable Controller provides you with the ability to update its firmware should the need arise. A firmware update is performed as follows:

1. Load the updated firmware (the file name will be: *.CMD where * = version number) in the root directory of a flash drive. The flash drive should not contain any other versions of the firmware.
2. Turn power to the Controller OFF by pressing the Power Key on the front of the Controller.
3. Place the Power Switch/Circuit Breaker on the rear of the unit in the OFF position.
4. Insert the flash drive in the USB A port on the back of the Controller.
5. Press and hold the SET key while placing the Power Switch/Circuit Breaker to the ON position. An hour glass image will appear on the display.
6. Continue holding the SET key until the display changes from black to white. Release the SET key when the message "Checking Image...This process takes several minutes, please wait" appears.
7. When "Standby" appears on the display, place the Power Switch/Circuit Breaker in the OFF position.
8. Return the Power Switch/Circuit Breaker to the ON position.
9. When "Standby" appears on the display, turn the Controller ON by pressing the Power Key on the front panel.
10. Press the Menu Key to access the Main Menu, select Service, and then verify that the Display Module Firmware version displayed on page 2 of the Service sub-menu matches the one you just loaded.
11. Return to the Main Menu, select Control, and then select Reset Memory and Reboot on page 2 of the Control sub-menu.
12. Enter the Restore Defaults password (1234) and touch OK. The Temperature Controller will power down and then reboot in standby.



NOTE: See *System Restoration* for information on restoring the Temperature Controller's original version of firmware.

Warning and Fault Messages

Warnings

Warnings alert you to conditions such as the disconnection of the external temperature sensor or that the desired set point is above or below the user-set limits. The warning message appears briefly on the status bar when the condition is detected. It also appears when power is turned Off and then back On.

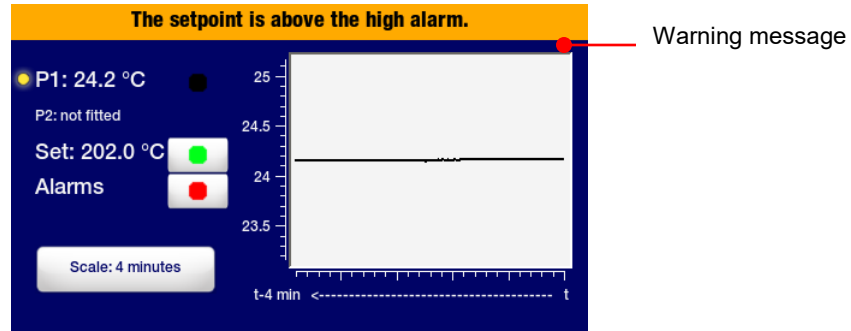

Warning Message	Cause	Corrective Action
The set point is above the high limit	Desired set point temperature is above High Limit setting	Lower set point temperature or increase High Limit setting
The set point is below the low limit	Desired set point temperature is below Low Limit setting	Raise set point temperature or decrease Low Limit setting
Probe 2 has been disconnected	External temperature probe disconnected	Reconnect external temperature probe or select internal (P1) control.
The set point is above the safety set point	Desired set point temperature is above the safety set temperature	Lower set point or increase safety set temperature
Service air filter and reset	Air filter cleaning maintenance reminder	Clean air filter and reset service reminder
The fluid should be replaced	Bath fluid replacement maintenance reminder	Replace bath fluid and reset service reminder
The fluid is above the high alarm	Bath fluid temperature above High Alarm setting	Allow bath fluid to cool or increase High Alarm setting
The fluid is below the low alarm	Bath fluid temperature is below Low Alarm setting	Allow bath fluid to warm or decrease Low High Alarm setting

Faults

Faults alert you to conditions which may compromise safety or component failures which affect performance. When a fault condition is detected, power to the heater, condenser, and pump are disconnected and a fault message appears continuously on the display. The fault message includes the type of fault, cause, and corrective action.

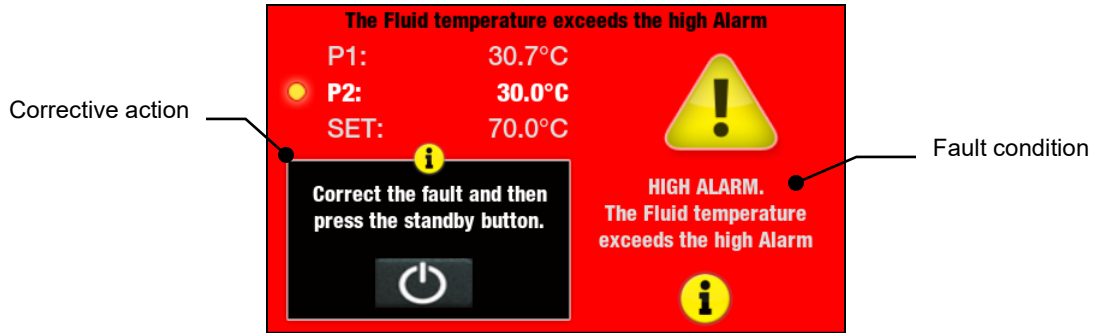

Fault Messages	Cause	Corrective Action
COOLING MODULE DISCONNECTED	The refrigeration control module, detected when the unit was last powered, is no longer present.	Reconnect the refrigeration control cable and re-power unit.
EXTERNAL PROBE FAILURE Note: This fault will only appear if External (P2) Control is active.	The external temperature probe may have failed.	Check that the external temperature probe is plugged in correctly. Inspect probe for damage such as frayed or exposed wires. If problem persists, please contact your supplier.
HIGH ALARM	The fluid temperature exceeds the High Alarm setting. Fluid is too warm.	Decrease fluid temperature or increase High Alarm setting. If problem persists, please contact your supplier.
HIGH SAFETY ALARM	The fluid temperature exceeds the Safety Set.	Check fluid level. Check fluid temperature and set point. Ensure that Safety Set is higher than the fluid set point. If problem persists, please contact your supplier.
INTERNAL FAILURE	An internal failure may have occurred.	Check your set up. If problem persists, please contact your supplier.
INTERNAL PROBE FAILURE	The internal temperature probe may have failed.	If problem persists, please contact your supplier.
LOW ALARM	The fluid temperature is lower than the Low Alarm. Fluid is too cold.	Increase temperature set point or decrease Low Alarm setting. . If problem persists, please contact your supplier.
LOW LIQUID LEVEL.	The float switch has activated.	Check the fluid level in the bath, and add more fluid if required.
LOW LIQUID LEVEL DETECTED	Low liquid level has been detected through either activation of the float switch or the detection of an over-temperature condition.	Recheck your fluid level, and recheck your alarm settings.

Troubleshooting Chart

Problem	Possible Causes	Corrective Action
Unit does not run (Digital Display is blank)	No power to unit	Check that the electrical cord is secure and connected to an operating electrical outlet.
Unit does not run (STANDBY appears on Digital Display)	Unit in Standby mode	Press Power Key on front panel.
No fluid circulation	Insufficient fluid in reservoir Pump impeller jammed	Add fluid to reservoir. Inspect pump and remove debris as required.
Insufficient circulation	Fluid viscosity too high External tubing diameter too small Low line voltage	Replace with lower viscosity bath fluid. Replace with larger diameter tubing. Check and correct as required.
Unit does not heat	Insufficient fluid in reservoir Temperature set point too low Safety Set Temperature too low	Add fluid to reservoir. Increase temperature set point. Increase Safety Set temperature.
Insufficient heating	Insufficient circulation Low line voltage Ambient temperature too cool Excessive heat loss	See Insufficient Circulation, above. Check and correct as required. Increase ambient temperature or relocate unit. Check for heat loss from external tanks and hoses; Check for vapor/heat loss from internal reservoir.
Temperature unstable	Insufficient circulation Debris or mineral build-up on pump, heater, or temperature sensor.	Check pump flow and operation. Clean as required.
Unit does not cool	Dust build up on air filter or condenser Blocked air ventilation screens Temperature set point is too high Excessive heat load Ambient air temperature too high (>35°C / 95°F) Low or high line voltage	Clean air filter and/or condenser as required. Remove blockages as required. Decrease temperature set point. Check that heat load does not exceed capacity of bath; correct as required. Decrease ambient air temperature. Check and correct as required.

Problem	Possible Causes	Corrective Action
Insufficient cooling	Dust build up on air filter or condenser Blocked air ventilation screens Temperature set point is too high Excessive heat load Ambient air temperature too high (>35°C / 95°F) Low or high line voltage	Clean air filter and/or condenser as required. Remove blockages as required. Decrease temperature set point. Check that heat load does not exceed capacity of bath; correct as required. Decrease ambient air temperature. Check and correct as required.
Unable to achieve low end extreme temperatures	Pump speed too high Incorrect bath fluid Insufficient insulation on external fluid lines Ambient air temperature too high (>35°C / 95°F) Low or high line voltage Dust build up on air filter or condenser Blocked air ventilation screens Excessive heat load	Reduce pump speed. Check that the fluid being circulated is capable of reaching the required temperature. Check external fluid lines for proper insulation. Decrease ambient air temperature as required. Check and correct as required. Clean air filter or condenser as required. Remove blockages as required. Check that heat load does not exceed capacity of bath; correct as required.

Technical Information

Performance Specifications

Operating Temperature Range:	Model dependent; see table below	
Temperature Stability:	±0.005°C (±0.01°F)	
Pump Type:	Variable speed pressure/suction	
	<u>60Hz models</u>	<u>50Hz models</u>
Maximum Pressure:	4.3 psi (0.30 bar)	3.6 psi (0.25 bar)
Maximum Pressure Flow Rate:	5.3 gpm (20.1 lpm)	4.4 gpm (16.7 lpm)
Maximum Suction Flow Rate:	3.9 gpm (14.7 lpm)	3.2 gpm (12.2 lpm)
Heater Wattage:	1100 watts	2200 watts

Model Type	Reservoir Capacity	Temperature Range	Electrical Requirements	
			60Hz	50Hz
AP07R-20 Refrigerating / Heating Bath	7 liters	-20° to 200°C -4° to 392°F	120V, 60Hz, 12A	240V, 50Hz, 12A
AP07R-40 Refrigerating / Heating Bath	7 liters	-40° to 200°C -40° to 392°F	120V, 60Hz, 12A	240V, 50Hz, 12A
AP7LR-20 Refrigerating / Heating Bath	7 liters	-20° to 200°C -4° to 392°F	120V, 60Hz, 12A	240V, 50Hz, 12A
AP15R-30 Refrigerating / Heating Bath	15 liters	-30° to 200°C -22 to 392°F	120V, 60Hz, 13A	240V, 50Hz, 13A
AP15R-40 Refrigerating / Heating Bath	15 liters	-40° to 200°C -40° to 392°F	120V, 60Hz, 13A	240V, 50Hz, 13A
AP20R-30 Refrigerating / Heating Bath	20 liters	-30° to 200°C -22° to 392°F	120V, 60Hz, 13A	240V, 50Hz, 13A
AP28R-30 Refrigerating / Heating Bath	28 liters	-30° to 200°C -22° to 392°F	120V, 60Hz, 13A	240V, 50Hz, 13A
AP45R-20 Refrigerating / Heating Bath	45 liters	-25° to 135°C -13° to 275°F ⁽¹⁾	208-240V, 50/60Hz, 13A	208-240V, 50/60Hz, 13A
AP75R-20 Refrigerating / Heating Bath	75 liters	-20° to 100°C -4° to 212°F ⁽¹⁾	208-240V, 50/60Hz, 13A	208-240V, 50/60Hz, 13A
AP07H200 Heating Only Bath	7 liters	Ambient +10° to 200°C Ambient +20° to 392°C	120V, 60Hz, 10A	240V, 50Hz, 10A
AP15H200 Heating Only Bath	15 liters	Ambient +10° to 200°C Ambient +20° to 392°F	120V, 60Hz, 10A	240V, 50Hz, 10A
AP20H200 Heating Only Bath	20 liters	Ambient +10° to 200°C Ambient +20° to 392°F	120V, 60Hz, 10A	240V, 50Hz, 10A
AP28H200 Heating Only Bath	28 liters	Ambient +10° to 200°C Ambient +20° to 392°F	120V, 60Hz, 10A	240V, 50Hz, 10A
AP06S150 Stainless Steel Open Tank	6 liter	Ambient +10° to 150°C Ambient +20° to 302°F	120V, 60Hz, 10A	240V, 50Hz, 10A
AP10S150 Stainless Steel Open Tank	10 liter	Ambient +10° to 150°C Ambient +20° to 302°F ⁽²⁾	120V, 60Hz, 10A	240V, 50Hz, 10A
AP20S150 Stainless Steel Open Tank	20 liter	Ambient +10° to 150°C Ambient +20° to 302°F ⁽²⁾	120V, 60Hz, 10A	240V, 50Hz, 10A
AP28S150 Stainless Steel Open Tank	28 liter	Ambient +10° to 150°C Ambient +20° to 302°F ⁽²⁾	120V, 60Hz, 10A	240V, 50Hz, 10A
AP08P100 Polycarbonate Open Tank	8 liter	Ambient +10° to 85°C Ambient +20° to 185°F ⁽³⁾	120V, 60Hz, 10A	240V, 50Hz, 10A
AP11P100 Polycarbonate Open Tank	11 liter	Ambient +10° to 85°C Ambient +20° to 185°F ⁽³⁾	120V, 60Hz, 10A	240V, 50Hz, 10A
AP14P100 Polycarbonate Open Tank	14 liter	Ambient +10° to 85°C	120V, 60Hz,	240V, 50Hz,

		Ambient +20° to 185°F ⁽³⁾	10A	10A
AP17P100 Polycarbonate Open Tank	17 liter	Ambient +10° to 85°C Ambient +20° to 185°F ⁽³⁾	120V, 60Hz, 10A	240V, 50Hz, 10A
AP23P100 Polycarbonate Open Tank	23 liter	Ambient +10° to 85°C Ambient +20° to 185°F ⁽³⁾	120V, 60Hz, 10A	240V, 50Hz, 10A
AP28P100 Polycarbonate Open Tank	28 liter	Ambient +10° to 85°C Ambient +20° to 185°F ⁽³⁾	120V, 60Hz, 10A	240V, 50Hz, 10A
AP29VB5R Polycarbonate Viscosity	29 liter	Ambient +10° to 85°C Ambient +20° to 185°F ⁽³⁾	120V, 60Hz, 10A	240V, 50Hz, 10A
AP29VB3S Polycarbonate Viscosity	29 liter	Ambient +10° to 85°C Ambient +20° to 185°F ⁽³⁾	120V, 60Hz, 10A	240V, 50Hz, 10A
PP15RCAL Refrigerating Calibration Bath	15 liters	-30° to 200°C -22° to 392°F	120V, 60Hz, 13A	240V, 50Hz, 13A

1. Maximum operating temperature at which $\pm 0.005^\circ\text{C}$ temperature stability can be maintained; Advanced Programmable Controller is capable of higher temperatures.
2. Maximum operating temperature for stainless steel tank; Advanced Programmable Controller is capable of higher temperatures.
3. Maximum operating temperature for polycarbonate tank; Advanced Programmable Controller is capable of higher temperatures.





Environmental Conditions Indoor use only

Maximum Altitude:	2000 meter
Operating Ambient:	5° to 35°C (41° to 95°F)
Relative Humidity:	80%, non-condensing
Installation Category:	II
Pollution Degree:	2
Ingress Protection:	IP 31
Climate Class:	SN
Software Class:	B
Output Waveform:	Sinusoidal

Specifications subject to change without notice.

Reservoir Fluids

Depending on your needs, a variety of fluids can be used with your Circulator. No matter what bath fluid is selected, it must be chemically compatible with the reservoir and the materials in your Circulator. It must also be suitable for the desired temperature range.

	<p>WARNING: When using Class III flammable fluids per DIN 12876-1, the user must attach the following warning labels to the front of the unit so that they are well visible:</p>		
	<p>Warning Label W09 Colors: Yellow/black</p>		<p>Danger Area. Attention! Observe instructions (operating manual, safety data sheet)</p>
<p>Mandatory Label M018 Colors: Blue/white</p> <p>Or</p> <p>Semi S1-0701 Table A1-2 #9 Colors: Blue/white</p>		<p>Carefully read the user information prior to beginning operation. Scope: EU</p>	
		<p>Carefully read the user information prior to beginning operation. Scope: NAFTA</p>	

	<p>WARNING: Always use fluids that satisfy safety, health, and equipment compatibility requirements. Be aware of the chemical hazards that may be associated with the bath fluid used. Observe all safety warnings for the fluids used as well as those contained in the material safety data sheet.</p>
---	---

For optimum temperature stability, the fluid's viscosity should be 50 centistokes or less at its lowest operating temperature. This permits good fluid circulation and minimizes heating from the pump.

For temperatures from 10°C to 90°C, distilled water is recommended. For temperatures below 10°C, a mixture of laboratory grade ethylene glycol and water should be used. Do not use deionized water.

The following chart is intended to serve as a guide in selecting a bath fluid for your application. For optimum temperature stability and low vaporization, be sure to stay within the fluid's normal temperature range.

You are responsible for proper selection and use of the fluids. Avoid extreme range operation.

Fluid Description	Viscosity (cSt) @ 25°C	Specific Heat			Normal Temperature Range	Extreme Temperature Range
		@ Fluid Temperature	BTU/lb°F	KJ/Kg°C		
distilled water	1	50°C	1.00	4.18	10° to 90°C	2° to 100°C
polyclear MIX 30	1	50°C	1.00	4.18	15° to 90°C	2° to 100°C
polytherm S150	50	100°C	0.41	1.71	50° to 150°C	5° to 270°C*
polytherm S200	125	150°C	0.40	1.67	100° to 200°C	80° to 232°C*
polytherm S250	500	200°C	0.39	1.63	150° to 250°C	125° to 260°C*
polytherm M170	40	85°C	0.40	1.67	50° to 170°C	25° to 190°C
polyclear HC -50	3	-30°C	0.62	2.59	-50° to 100°C	-62° to 118°C
polyclear EG -25 (50/50 mix with distilled H ₂ O)	20	-20°C	0.78	3.26	-25° to 100°C	-30° to 115°C
polyclear EG -25 (30/70 mix with distilled H ₂ O)	12	0°C	0.89	3.72	0° to 95°C	-15° to 107°C
polyclear PG -20 (50/50 mix with distilled H ₂ O)	20	-10°C	0.83	3.47	-20° to 100°C	-30° to 115°C
polyclear PG -20 (30/70 mix with distilled H ₂ O)	12	5°C	0.92	3.85	5° to 90°C	-10° to 107°C
polyclear MIX -25 (50/50 mix with distilled H ₂ O)	20	-20°C	0.78	3.26	-25° to 100°C	-30° to 115°C
polyclear MIX -25 (30/70 mix with distilled H ₂ O)	12	0°C	0.89	3.72	0° to 95°C	-15° to 107°C



***WARNING:** This is the fluid's flash point temperature.



WARNING: DO NOT USE THE FOLLOWING LIQUIDS

- Automotive antifreeze with additives**
- Hard tap water**
- Deionized water with a specific resistance > 1 meg ohm
- Concentrations of acids or bases
- Solutions with halides: chlorides, fluorides, bromides, iodides or sulfur
- Bleach (Sodium Hypochlorite)
- Solutions with chromates or chromium salts
- Glycerine
- Syltherm fluids

** At temperatures above 40°C, additives or mineral deposits can adhere to the heater. If deposits are allowed to build up, the heater may overheat and fail. Higher temperatures and higher concentrations of additives will hasten deposit build up.

Application Notes

At a fluid's low temperature extreme:

- The presence of ice or slush adversely affects temperature stability.
- A viscosity above 10 centistokes adversely affects temperature uniformity.
- A high fluid viscosity and high pump speed adds heat to the fluid being pumped.

At a fluid's temperature above ambient without refrigeration:

- If your set point temperature is less than 15°C above the ambient temperature, the viscosity of the fluid should be 10 centistokes or less to minimize friction heating of the fluid.
- Heat loss should be encouraged by uncovering the fluid and lowering the pump speed.

At fluid's high temperature extreme:

- Heat loss from vapor adversely affects temperature stability.
- To prevent the accumulation of vapors inside the room, the reservoir may need to be placed in a fume hood.
- Use a cover and/or floating hollow balls to help prevent heat and vapor loss.
- Replenish fluid lost from vapor frequently.

Tubing and Fitting Temperature Ranges

Material	Temperature Range
Buna N tubing	-40° to 120°C
Viton® tubing	-32° to 200°C
Braided Teflon® lined tubing	-50° to 225°C
Stainless steel fittings	-45° to 225°C
Nylon fittings	-40° to 90°C
Brass fittings	-40° to 80°C

Fluid Compatibility

	Buna N Tubing	Viton Tubing	Braided Teflon Tubing	Stainless Steel Fittings	Nylon Fittings	Brass Fittings
polycool EG -25	A	A	A	B	A	B
polycool PG -20	A	A	A	B		B
polycool HC -50	B	B	A	B	B	B
polytherm S150	B	B	A	B		B
polytherm S200	B	B	A	B		B
polytherm S250	B	B	A	B		B
polytherm M170)	A	A	A	A		B
polycool MIX -25	A	A	A	B	A	B
polyclear MIX 30	A	A	A	A	A	A

A = Excellent B = Good

RS232/RS485 Communications



CAUTION: Always turn electrical power to the Circulator OFF before making a connection to the serial (DB9) port.

Serial Connector — A DB9 connector is provided on the back panel of the Controller for RS232/RS485 data communication.

Pin	RS232	RS485
1		
2	TX	A
3	RX	
4	DTR	
5	GND	GND
6	DSR	
7	RTS	
8	CTS	B
9		

Serial Communications Protocol — The Controller uses the following serial communications settings:

Data bits — 8

Parity — None

Stop bits — 1

Flow control — None

Baud rate — Selectable (Controller/PC baud rates must match). 57600 is recommended.

Communications Commands — RS232 commands must be entered using the command only; RS485 commands must be entered using @ and the RS485 address (E.g., @001) followed by the actual command. All commands must be entered in the exact format shown. Do not send a [LF] (line feed) after the [CR] (carriage return). Be sure to follow character case exactly.

A response followed by an exclamation point (!) indicates that a command was executed correctly. A question mark (?) indicates that the Controller could not execute the command (either because it was in an improper format or the values were outside the allowable range). A response must be received from the Controller before another command can be sent. All responses are terminated with a single [CR].

Command	Format	Values	Return Message
Set Command Echo	SEi[CR]	Echo: i = 1 No Echo: i = 0	![CR]
Set Set Point	SSiii.ii[CR]	i = any integer from 0-9	![CR]
Set On Off	SOi[CR]	On: i = 1 Off: i = 0	![CR]
Set High Alarm	SHiii[CR]	i = any integer from 0-9	![CR]
Set Low Alarm	SLiii[CR]	i = any integer from 0-9	![CR]
Set Pump Speed	SMi[CR]	i = any integer from 5-100 in increments of 5	![CR]
Set Restart Power Status	SWi[CR]	Restart: i = 1 Standby: i = 0	![CR]
Set Internal / External Control	SJi[CR]	External: i = 1 Internal: i = 0	![CR]
Read Set Point Temperature	RS[CR]		iii.ii[CR]
Read Temperature Unit	RU[CR]		C[CR] or F[CR]
Read Internal Temperature	RT[CR]		iii.ii[CR]
Read External Temperature	RR[CR]		iii.ii[CR]
Read Operating Status	RO[CR]	Running: i = 1 Standby: i = 0	i[CR]
Read High Alarm Setting	RH[CR]		iii[CR]
Read Low Alarm Setting	RL[CR]		iii[CR]
Read Pump Speed	RM[CR]	Low: i = 1 High: i = 2	i[CR]
Read Alarm Status	RF[CR]	No Faults: i = 0 Fault: i = 1	i[CR]
Read the Auto-Cool Set Point	RA[CR]		ii[CR]
Read Number of Program Running	RV[CR]		ii[CR]
Read Number of Steps in Program Running	Rs[CR]		ii[CR]
Read Number of Loops in Program Running	RK[CR]		ii[CR]
Read Current Program Step	RC[CR]		ii[CR]
Read Program Status	RG[CR]	Running: i = 1 Stopped: i = 0 Paused: i = 2	i[CR]
Read Current Program Loop	RI[CR]		ii[CR]
Read Elapsed Time from Program Start	RE[CR]	Format: h:mm:ss	ii[CR]
Read the Firmware Version	RB[CR]		i-ii-iii[CR]

Remote ON / OFF



WARNING: Always turn electrical power to the Circulator OFF before making a connection to the serial (DB9) port.

The DB9 connector on the rear of the Temperature Controller can also be used to turn the Circulator ON or OFF via a contact closure or VDC control room signal.

Contact Closure — To use a contact closure to turn the Circulator ON and OFF, connect pin 1 to 5. The Circulator will be ON when the switch is closed and OFF when the switch is open.

VDC Signal — To use a VDC signal to turn the Circulator ON and OFF, connect to pins 9 (Positive) and 5 (Ground). The Circulator will be ON when a +9 to +24 VDC signal is applied; it will be OFF when the signal is removed.

USB Data Logging

Data is stored in a CSV file that can be read in spreadsheet programs such as Microsoft Excel®. The data is output in the following format:

MIN.SEC	[V]	UNIT	SET	P1	P2
4	[v0013]	C	10	15.19	14.89
4	[v0013]	C	10	15.18	14.88
4.22	[v0013]	C	10	15.03	14.71
4.23	[v0013]	C	10	15.02	14.7
4.24	[v0013]	C	10	15	14.69
4.25	[v0013]	C	10	15	14.69
4.26	[v0013]	C	10	14.99	14.68
4.27	[v0013]	C	10	14.98	14.67

MIN.SEC = Minutes and seconds.

V = Firmware version.

UNIT = Selected temperature unit.

SET = Temperature set point

P1 = Fluid temperature as measured by the Internal probe

P2 = Fluid temperature as measured by the External probe (if connected)



NOTE: The time stamp on the first line of data represents the time when data began being logged. The time stamp will indicate 0.01 if data logging was enabled after a flash drive or computer was connected to the USB port. It will show a later time if data logging was enabled before the storage device was connected. In the example shown above, the flash drive was connected to the USB port 4 minutes after data logging was enabled.

USB B Setup, Monitoring, and Control

The Advanced Programmable Temperature Controller can be monitored and controlled using a personal computer connected to its USB B port.

Initial Setup

1. Plug the USB A connector of a USB A to USB B cable into an open USB port on the personal computer and plug the USB B connector into the corresponding port on the Temperature Controller.
2. The computer operating system will automatically detect a new device and ask to install the drivers for the device. The drivers are located on the Resource Disk that came with your Temperature Controller.
3. Place the Resource Disk in the computer's CD drive and install the drivers.
4. Determine the identity of the communications port your computer assigned to the Temperature Controller.

Monitoring and Control

When all connections have been made and drivers installed, you can monitor and control the Temperature Controller using a terminal program and the active serial communications commands.

Ethernet Configuration



NOTE: The Advanced Programmable Controller's Ethernet capabilities may be used with any of the following web browsers: Internet Explorer 9.0 or later, Firefox, Chrome, Safari, or Opera.

The Advanced Programmable Controller may be connected directly to a laptop or desktop computer via its Ethernet connection or indirectly via your facility's wired or wireless network. Either type of connection enables you to control and/or monitor the operation of your circulating bath in real time using an Internet browser by entering its IP address. The Controller's active serial communications commands are used to retrieve and/or change operational information.

Direct Computer to Controller Configuration



NOTE: If your computer is already connected to a wired network, you will not be able to directly connect it to your circulating bath's Temperature Controller.

1. Open the utility that displays your computer's available network connections.
2. Select an available wired connection.
3. Enter the following properties for the selected connection:
 - A. Internet protocol: TCP/IP
 - B. IP address: any three sets of identical numbers (e.g., 111.111.111) followed by a single digit (e.g., 111.111.111.5).
 - C. Subnet mask: 255.255.255.0
4. Enter the IP address into your Controller as outlined in *Static IP Addressing*, below. Please note that the first three series of numbers in IP address on the Controller must match those entered in Step 3B, above. The last number does not have to match.

Wired or Wireless Network Configuration

The Advanced Programmable Controller supports both dynamic (DHCP) and static IP configuration. The default value is Static. With either type of IP configuration, it may be necessary to work with your IT department to ensure that both the network and your Controller are configured properly.

1. Press  to access the Main Menu.



2. Touch Connect to access the Connect sub-menu.



3. Touch Ethernet to access the IP address screen. Depending on the current configuration, one of the following screens will appear:

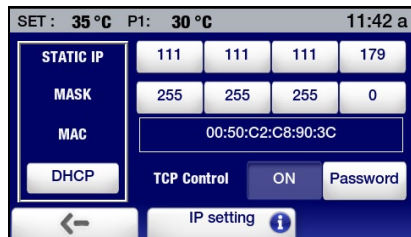

Static IP address screen

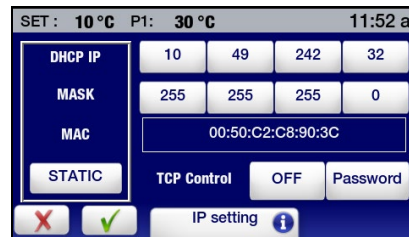

Dynamic IP address screen

Static IP Addressing — If your Controller will be connected directly to a computer or your network uses static IP addressing, you must manually enter the IP address that will be used into your Controller. This is done as follows:

1. Select Static and touch .

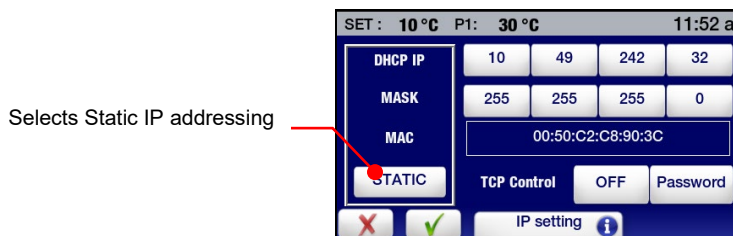

2. Select an IP address field, enter the correct IP address, and touch . Repeat for the first three IP address fields.

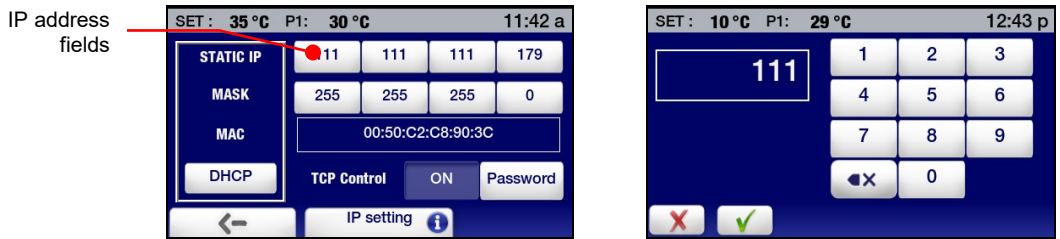

Dynamic IP Addressing — If your network uses DHCP (Dynamic Host Configuration Protocol), all you need to do is set your Controller for DHCP. The correct address will appear automatically when you connect the Controller to the network.



TCP Control Configuration

In order to make operational changes (set point, high/low limits and alarms, etc.) through an internet browser, the TCP Control function must be ON and a password set on the Temperature Controller's IP settings screen. You must enter this password in the browser screen's Login field before you are allowed to change the Temperature Controller's operational settings.

TCP control is turned ON and a password created as follows:

1. Select Ethernet from the Connect sub-menu. The IP settings screen will appear:

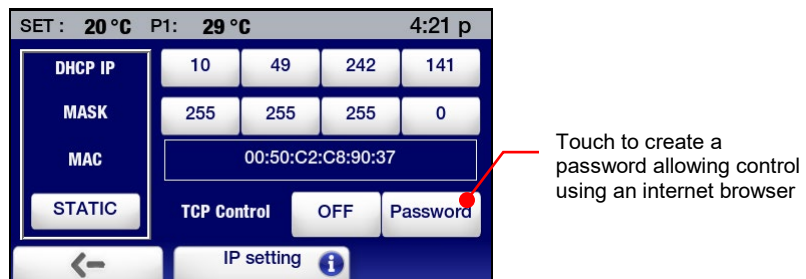

2. Select Password, create a password (8 characters maximum), and touch ✓.



3. Turn TCP Control ON and touch ✓.



Touch to turn TCP Control ON

External Cooling Control

	CAUTION: External Cooling Control settings are always displayed and set in °C.
--	---

	NOTE: The Circulator must be equipped with the optional external cooling control valve in order to use this function. Refer to the instructions included with the optional External Cooling Control Valve for installation information.
--	--

External cooling control provides you with a means of quickly cooling the bath fluid after a period of operation at an elevated temperature. When properly configured, it also prevents the bath from cooling to a temperature below that which is intended.

General Operation

External cooling control allows you to initiate a controlled cool down of the bath fluid after operation at an elevated temperature by automatically and incrementally closing the valve as the bath temperature decreases.

1. When the bath temperature is above the Maximum Set value, the external cooling valve is fully open (100%).
2. When bath temperature is between the Maximum Set and Minimum Set values, the external cooling valve is partially open (user-adjustable from 10% to 90%).
3. When the bath temperature is below the Minimum Set value, the external cooling valve is fully closed (0%).

Configuring External Cooling Control

1. Select External Cooling Control from the second page of the Control sub-menu. The External Cooling Control setup screen will appear.

Touch to access External Cooling Control setup

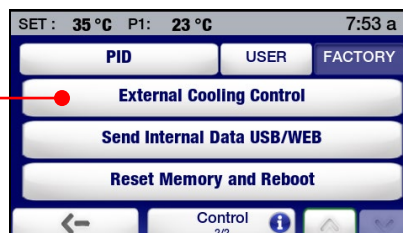

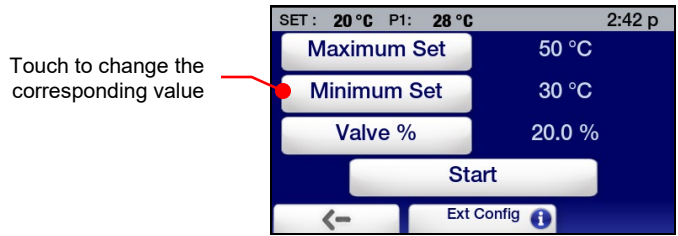

2. Enter the desired Maximum Set, Minimum Set, and Valve % values for the external cooling valve. Select a value to change by touching the corresponding button. Enter the desired value using the numeric keypad that appears and then touch \checkmark to accept the new value.



Maximum Set — At bath temperatures above this value, the valve will be open 100%. The Maximum Set value can be set from 40° to 80°C.

Minimum Set — At bath temperature below this value, the valve will be fully closed. The Minimum Set value can be set from 20° to 35°C.

Valve % — This is the valve setting when bath temperature is between the Maximum Set and Minimum Set values. The Value % can be set from 10% to 90% open.

3. Touch \checkmark to accept the new external cooling control settings.

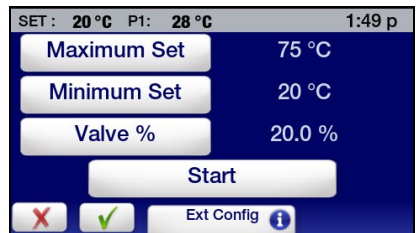

Operating External Cooling Control



CAUTION: Be sure to deactivate external cooling control once bath temperature has cooled to the desired temperature. Failure to do so may result in excessive energy consumption and/or make it difficult to maintain a bath temperature that is higher than the Minimum Set value.

To initiate a cool down using external cooling control, select External Cooling Control from the second page of the Control sub-menu, touch Start and then \checkmark . The external cooling control valve will open (fully or partially, depending on bath temperature and settings). The external cooling control valve will automatically close once the bath temperature reaches the Minimum Set value.

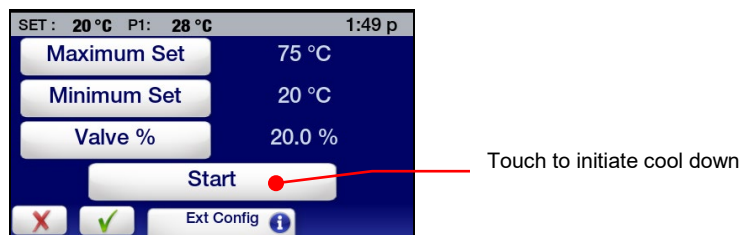

When the bath has cooled to the desired temperature, external cooling control can be deactivated by selecting External Cooling Control from the Control sub-menu, touching Stop, and then √.

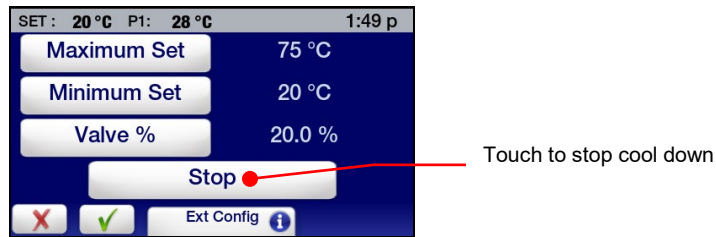

Equipment Disposal (WEEE Directive)

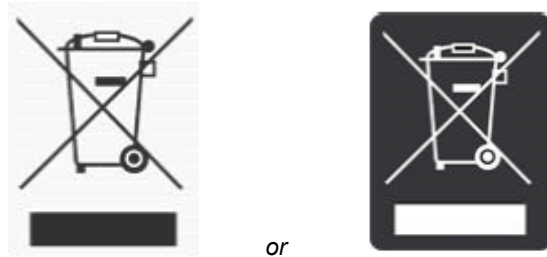

This equipment is marked with the crossed out wheeled bin symbol to indicate it is covered by the Waste Electrical and Electronic Equipment (WEEE) Directive and is not to be disposed of as unsorted municipal waste. **Any products marked with this symbol must be collected separately, according to the regulatory guidelines in your area.**

It is your responsibility to correctly dispose of this equipment at lifecycle-end by handing it over to an authorized facility for separate collection and recycling. It is also your responsibility to decontaminate the equipment in case of biological, chemical and/or radiological contamination, so as to protect the persons involved in the disposal and recycling of the equipment from health hazards. By doing so, you will help to conserve natural and environmental resources and you will ensure that your equipment is recycled in a manner that protects human health.

Requirements for waste collection, reuse, recycling, and recovery programs vary by regulatory authority at your location. Contact your local responsible body (e.g., your laboratory manager) or authorized representative for information regarding applicable disposal regulations.

Replacement Parts & Accessories

Description	Part Number
IEC to IEC Power Cord (Refrigerating/Heating Circulators) 120V, 60Hz	225-661
IEC to Mains Power Cord, U.S. plug type, 120V, 60Hz (7 to 28 liter Refrigerating/Heating Circulators)	225-473
IEC to Mains Power Cord, U.S. plug type, 230V, 60Hz (45 liter and 75 liter Refrigerating/Heating Circulators)	225-230
IEC to Mains Power Cord, European plug type, 240V, 50Hz (Refrigerating/Heating Circulators)	225-346
IEC to Mains Power Cord, U.S. plug type, 120V, 60Hz (Heating Circulators)	225-227
IEC to Mains Power Cord, European plug type, 240V, 50Hz (Heating Circulators)	225-228
Refrigeration Control Cable (Refrigerating/Heating Circulators)	225-651
Reservoir Cover for 7L Refrigerating/Heating and Heat only Circulators	510-726
Reservoir Cover for 15L Refrigerating/Heating and Heat only Circulators	510-727
Reservoir Cover for 20L Refrigerating/Heating and Heat only Circulators	510-728
Reservoir Cover for 28L Refrigerating/Heating and Heat only Circulators	510-729
Reservoir Cover for 45L Refrigerating/Heating and Heat only Circulator	510-730
Reservoir Cover (small) for 75L Refrigerating/Heating Circulator	510-730
Reservoir Cover (large) for 75L Refrigerating/Heating Circulator	510-731
Reservoir Cover for 15L Calibration Baths	510-732
Bypass Tubing Kit, Buna N	510-711
Bypass Tubing Kit, Viton®	510-495
Teflon-lined Tubing, stainless steel overbraid	060310
RS232 Cable, 9.8-ft (3 m)	225-173
USB A to USB B Cable, 6-ft (1.8 m)	225-669
Ethernet cable, 7-ft (2.1 m)	225-670
Flash Drive, 1 GB	250-096
Pt100 External Temperature Probe, 2-ft (0.6 m)	525-876
Pt100 External Temperature Probe, 10-ft (2 m)	525-870
Pt100 External Temperature Probe, 25-ft (8 m)	525-871
Pt100 External Temperature Probe, 50-ft (15 m)	525-872
USB A to USB B Cable, 9-ft (3 m)	225-669
Fitting, ¼" male NPT to 1/8" (3 mm) hose barb, brass (set of 2)	060305-2
Fitting, ¼" male NPT to 3/16" (5 mm) hose barb, stainless steel (1 each)	776-204
Fitting, ¼" male NPT to 3/16" (5 mm) hose barb, nylon (1 each)	300-049
Fitting, ¼" male NPT to 3/16" (5 mm) hose barb, brass (1 each)	776-193
Fitting, ¼" male NPT to ¼" (6 mm) hose barb, nylon (1 each)	300-048
Fitting, ¼" male NPT to ¼" (6 mm) hose barb, brass (1 each)	776-194
Fitting, ¼" male NPT to ¼" (6 mm) hose barb, stainless steel (1 each)	776-203

Description	Part Number
Fitting, ¼" male NPT to 5/16" (8 mm) hose barb, brass (set of 2)	060305
Fitting, ¼" male NPT to 3/8" (9.5 mm) hose barb, stainless steel (1 each)	776-202
Fitting, ¼" male NPT to 3/8" (9.5 mm) hose barb, nylon (1 each)	300-047
Fitting, ¼" male NPT to 3/8" (9.5 mm) hose barb, brass (1 each)	776-195
Fitting, ¼" male NPT to M16 x 1, stainless steel (1 each)	775-290
Fitting, M16 x 1 female to 8 mm (1/4") hose barb, brass (1 each)	776-191
Fitting, M16 x 1 female to 12 mm (7/16") hose barb, brass (1 each)	776-192
Fitting, ½" male NPT x ½" (13 mm) hose barb, nylon (for integrated cooling coil)	300-096
Flow Adapter, 2 ports with shutoffs. ¼" male NPT x two ¼" (6 mm) hose barbs, brass	510-666
Digital to Analog Adapter, 10 mV	215-471
Reusable Air Filter for AP7LR-20 Refrigerating/Heating Circulator	305-057
Reusable Air Filter for PP07R-20 and AP07R-40 Refrigerating/Heating Circulator, AP15RCAL Calibration Bath	305-054
Reusable Air Filter for AP15R-30, AP15R-40, AP20R-30 and AP28R-30 Refrigerating/Heating Circulators	305-055
Reusable Air Filter for AP45R-20 and AP75R-20 Refrigerating/Heating Circulators	305-056
O-Ring, Drain Valve (for Refrigerating/Heating and Heat only Circulators)	400-843
Display Module Assembly	510-528
Bezel for Display	300-676
Circuit Breaker / Power Switch	215-330
Leveling Glide; Refrigerating/Heating and Heat only Circulators	400-814
Sleeve kit for calibration bath lid: 2 mm inserts x (2), 4.0 mm insert x (1)	510-748
Sleeve kit for calibration bath lid: 3 mm inserts x (2), 4.0 mm insert x (1)	510-745
Sleeve kit for calibration bath lid: 4 mm inserts x (2), 4.0 mm insert x (1)	510-746
Sleeve kit for calibration bath lid: 5 mm inserts x (2), 4.0 mm insert x (1)	510-749
Sleeve kit for calibration bath lid: 6 mm inserts x (2), 4.0 mm insert x (1)	510-747
Sleeve kit for calibration bath lid: 8 mm inserts x (2), 4.0 mm insert x (1)	510-750
Solid plug for calibration bath lid, Viton®	300-831
Resource Disk (with Operator's Manual)	110-815

PolyScience Circulating Bath Fluids

Circulating Bath Fluid	Quantity	Part Number
polyclean Algaecide	8 oz / 236 ml	004-300040
polyclean Algaecide	Twelve 8 oz / 236 ml bottles	004-300041
polyclean Bath Cleaner	8 oz / 236 ml	004-300050
polyclean Bath Cleaner	Twelve 8 oz / 236 ml bottles	004-300051
polycool EG -25 (ethylene glycol)	1 gal / 4.5 liter	060340
polycool PG -20 (propylene glycol)	1 gal / 4.5 liter	060320
polycool HC -50 (water-based heat transfer fluid)	1 gal / 4.5 liter	060330
polytherm S150 (silicone oil)	1 gal / 4.5 liter	060326
polytherm S200 (silicone oil)	1 gal / 4.5 liter	060327
polytherm S250 (silicone oil)	1 gal / 4.5 liter	060328
polytherm M170 (mineral oil)	1 gal / 4.5 liter	060321
polycool MIX -25 (50/50 blend polycool EG -25 / H ₂ O plus polyclean algaecide)	Five 0.5 gal / 2.27 liter	004-300060
polyclear MIX 30 (distilled water plus polyclean algaecide)	Five 0.5 gal / 2.27 liter	004-300062

Service & Technical Support

If you have followed the troubleshooting steps outlined previously and your Circulator still fails to operate properly, contact the supplier from whom the unit was purchased. Have the following information available for the customer service person:

Model, Serial Number, and Voltage (from back panel label)

Date of purchase and purchase order number

Supplier's order number or invoice number

A summary of the problem

Warranty

The manufacturer agrees to correct for the original user of the product, either by repair (using new or refurbished parts), or at the manufacturer's election, by replacement (with a new or refurbished product), any defects in material or workmanship which develop during the warranty period. The standard warranty is twenty-four (24) months after delivery of the product. In the event of replacement, the replacement unit will be warranted for the remainder of the original warranty period or ninety (90) days, whichever is longer. For purposes of this limited warranty, "refurbished" means a product or part that has been returned to its original specifications. In the event of a defect, these are your exclusive remedies.

If the product should require service, contact the manufacturer's/supplier's office for instructions. When return of the product is necessary, a return authorization number is assigned and the product should be shipped, transportation charges pre-paid, in either its original packaging or packaging affording an equal degree of protection to the indicated service center. To insure prompt handling, the return authorization number must be placed on the outside of the package. A detailed explanation of the defect should be enclosed with the item.

The warranty shall not apply if the defect or malfunction was caused by accident, neglect, unreasonable use, improper service, acts of God, modification by any party other than PolyScience, or other causes not arising out of defects in material or workmanship.

EXCLUSION OF IMPLIED WARRANTIES. THERE ARE NO WARRANTIES, EXPRESSED OR IMPLIED, INCLUDING, BUT NOT LIMITED TO, THOSE OF MERCHANTABILITY OR FITNESS FOR A PARTICULAR PURPOSE WHICH EXTEND BEYOND THE DESCRIPTION AND PERIOD AS STATED IN THE OPERATOR'S MANUAL INCLUDED WITH EACH PRODUCT.

LIMITATION ON DAMAGES. THE MANUFACTURER'S SOLE OBLIGATION UNDER THE WARRANTY IS LIMITED TO THE REPAIR OR REPLACEMENT OF A DEFECTIVE PRODUCT AND POLYSCIENCE SHALL NOT, IN ANY EVENT, BE LIABLE FOR ANY INCIDENTAL OR CONSEQUENTIAL DAMAGES OF ANY KIND RESULTING FROM USE OR POSSESSION OF THIS PRODUCT.

Some states do not allow: (A) limitations on how long an implied warranty lasts; or (B) the exclusion or limitation of incidental or consequential damages, so the above limitations or exclusions may not apply to you. This warranty gives you specific legal rights and you may have other rights that vary from state to state.

Manufactured by:

PolyScience

6600 W. Touhy Avenue Niles, IL 60714 U.S.A.

1-800-229-7569 • 1-847-647-0611

www.polyscience.com