

Goldleaf  *Scientific*

Instruction Manual

Homogenising System

X 120



Content

| | | |
|-------|---|----|
| 1 | User Instructions..... | 4 |
| 1.1 | Important Instructions for your safety..... | 4 |
| 1.2 | Danger symbols in this operating manual..... | 4 |
| 1.2.1 | Danger symbols:..... | 4 |
| 1.2.2 | Danger levels..... | 5 |
| 1.2.3 | Warning signs on the device..... | 5 |
| 2 | General safety warnings and instructions..... | 5 |
| 3 | General Information..... | 8 |
| 4 | Intended Use..... | 8 |
| 5 | Scope of delivery..... | 9 |
| 5.1 | Homogenizing tools and accessories (to be ordered separately):..... | 9 |
| 6 | Setting up and Starting up the Instrument..... | 10 |
| 6.1 | Unpacking the Instrument..... | 10 |
| 6.2 | Setting up the Instrument..... | 10 |
| 6.3 | Description Drive Unit X 120..... | 10 |
| 6.4 | Assembly of support rod..... | 11 |
| 6.5 | Attaching the drive unit to a pedestal stand..... | 11 |
| 6.6 | Inserting the homogenizing tool..... | 12 |
| 6.7 | Electrical Connection..... | 12 |
| 7 | Operation X 120..... | 13 |
| 7.1 | Description of the speed scale X 120..... | 13 |
| 7.2 | Exchanging the homogenizing shafts..... | 14 |
| 7.3 | Exchanging the generator:..... | 14 |
| 8 | Maintenance and Cleaning..... | 14 |
| 8.1 | Cleaning the drive unit X 120..... | 14 |
| 8.2 | Cleaning the homogenising tool..... | 15 |
| 8.3 | Maintenance of drive unit X 120..... | 15 |
| 8.4 | Maintenance homogenizing tools..... | 15 |
| 9 | Dismantling, Transport and Storage..... | 16 |
| 9.1 | Dismantling..... | 16 |
| 9.2 | Transport and Storage..... | 16 |
| 10 | Disposal..... | 16 |
| 11 | Warranty and Liability..... | 17 |
| 12 | Technical Data..... | 17 |
| 13 | Repairs..... | 17 |
| 14 | Repair Return Form..... | 18 |
| 25 | Declaration of conformity / Konformitätserklärung..... | 34 |

This page is intentionally left blank

1 User Instructions

1.1 Important Instructions for your safety



- Every user must read and understand this manual completely before use. Failure to do so can result in serious injury or death.
- Comply with all safety and accident-prevention regulations applicable to laboratory work.
- Follow general instructions for hazard prevention and general safety instructions, e.g. wear protection clothing, eye protection and gloves.
- This operating manual is part of the product. Thus, it must always be easily accessible.
- This instruction sheet does not purport to address all of the safety problems which might result from the use of this device, chemicals, reagents, apparatus or equipment employed in any specific test or protocols. It is the responsibility of the user to consult their authorized safety advisors and establish appropriate health and safety practices and then determine the application of regulatory limitations prior to use.
- Enclose this operating manual when transferring the device to another place.
- If this manual is lost, please request another one. Please contact your dealer or

Goldleaf Scientific









3300 Harrison st suite 2
Riverside, CA 92503
support@goldleaflabs.com
510-487-1390
www.goldleaflabs.com

1.2 Danger symbols in this operating manual

The safety instructions in this manual appear with the following danger symbols and danger levels:

1.2.1 Danger symbols:

| | | | |
|---|---------------------|---|-------------------------|
|  | Hazard point |  | Electrical shock |
|---|---------------------|---|-------------------------|

| | |
|---|---|
|  Risk of fire |  Explosion |
|  Crushing |  Hot surface |
|  Bio hazard |  Magnetic field |
|  Chemical hazard |  Material damage |

1.2.2 Danger levels

| | |
|------------------|--|
| ▲ DANGER | Will lead to severe injuries or death |
| ▲ WARNING | May lead to severe injuries or death |
| ▲ CAUTION | May lead to light to moderate injuries |
| NOTICE | May lead to material damage |

1.2.3 Warning signs on the device











▲ WARNING



This symbol indicates that it is imperative to read and understand the instruction manual prior to operating the instrument. Please highlight points which require special attention in your field of application so they are not overlooked. Disregard of warnings may result in impairment of serviceability as well as in physical harm to the user.

2 General safety warnings and instructions

| | |
|---|---|
|  | <p>▲ DANGER Risk of explosion.</p> <ul style="list-style-type: none"> Do not operate the device in the vicinity of highly flammable or explosive substances. The instrument is not explosion-proof. |
|---|---|

| | |
|---|---|
| | <ul style="list-style-type: none"> • Do not use this device for processing any substances which could generate an explosive atmosphere. • Do not use this device to process any explosive or highly reactive substances. • Do not use flammable or explosive substances near the instrument. |
|  | <p>⚠ DANGER Electric shock as a result of penetration of liquid.</p> <ul style="list-style-type: none"> • Do not allow any liquids to penetrate the inside of the housing • Switch off the device and disconnect the power plug before starting cleaning or disinfection work. The On/Off Switch on the device does not disconnect the device from the power source. • Use only closed tubes. • Only plug the device back in if it is completely dry, both inside and outside. |
|  | <p>Risk from incorrect supply voltage</p> <ul style="list-style-type: none"> • Only connect the device to voltage sources which correspond to the electrical requirements on the type label. |
|  | <p>⚠ WARNING Electric shock due to damage to device or mains cable</p> <ul style="list-style-type: none"> • Only connect the device to the mains supply if the device and the mains cable are undamaged • Only use devices that have been properly installed or repaired. • In case of danger, disconnect the device from the mains supply by pulling the power plug from the mains socket or by using the isolating device intended for this purpose (e.g. emergency stop switch) |
|  | <p>⚠ WARNING Lethal voltage inside the device</p> <ul style="list-style-type: none"> • Do not open the device. • Ensure that the housing is always closed and undamaged so that no parts inside the housing can be contacted by accident. • The On/Off Switch on the device does not disconnect the device from the power source. Remove the plug from the AC power outlet to disconnect the instrument from the mains supply entirely. • Do not allow any liquids to penetrate the inside of the housing. • Repairs are only to be carried out by trained service technicians. |
|  | <p>⚠ WARNING Damage to health due to corrosive or aggressive chemicals</p> <ul style="list-style-type: none"> • Observe all markings on the reagent bottles. • Always check the instrument for leaks and air bubbles. Special attention should be directed to determine that all push-ons, threaded connections and suction tubes are firmly in place before beginning operation. Leaking solutions may endanger persons and materials • Use proper connecting vessels, protective clothing and gloves. |

| | |
|---|--|
| | <ul style="list-style-type: none"> ● Avoid splashes ● When dispensing, maintain a physical distance between the instrument and the body. ● Dangerous and fuming chemicals must be dispensed in a fume hood. ● Only employ the instrument for the purpose intended by the manufacturer, and particularly within the resistance limits of the instrument. If in doubt, contact your supplier, or the manufacturer's factory representative at the phone number shown at the front page of this operating instruction. ● Always use the instrument in such a manner that neither the operator, nor any other person is endangered. |
|  | <p>▲WARNING Damages to health due to infectious liquids and pathogenic germs.</p> <ul style="list-style-type: none"> ● When handling infectious liquids and pathogenic germs, observe the national regulations, the biological security level of your laboratory, the material safety data sheets and the manufacturer's application notes. ● Wear personal protective equipment ● For comprehensive regulations about handling germs or biological material of the risk group II or higher, please refer to the "Laboratory Biosafety Manual" in its respectively current valid version from the World Health Organisation |
|  | <p>▲WARNING Damage to health due to contaminated device and accessories</p> <p>In the following cases, sample material can be released:</p> <ul style="list-style-type: none"> - improperly sealed tubes - unstable tubes - high vapour pressure of the content so that the seal of the tubes can spring open - damaged sealing's - smashed glass tubes <ul style="list-style-type: none"> ● Only mix in closed tubes ● Observe the nationally prescribed safety environment when working with hazardous, toxic and pathogenic samples. Pay particular attention to personal protective equipment (gloves, clothing, goggles, etc.), extraction, and the safety class of the lab. ● Decontaminate the device and the accessories before storage and shipping. |
|  | <p>▲WARNING Risk of fire</p> <ul style="list-style-type: none"> ● Do not use this device to process any highly flammable liquids |
|  | <p>▲CAUTION Poor safety due to inadequate fixing of the unit</p> <ul style="list-style-type: none"> ● Ensure that the unit is firmly attached to a solid stand. |

| | |
|---|--|
|  | <p>⚠CAUTION Poor safety due to incorrect accessories and spare parts.</p> <p>The use of accessories and spare parts other than recommended by Goldleaf Scientific may impair the safety, function and precision of the device.</p> <p>Goldleaf Scientific cannot be held liable or accept any liability for damage resulting from the use of incorrect or non-recommended accessories and spare parts, or from the improper use of such equipment.</p> <ul style="list-style-type: none"> • Only use accessories and spare parts recommended by Goldleaf Scientific |
|  | <p>⚠CAUTION Crush hazard due to moving parts</p> <ul style="list-style-type: none"> • Do not replace any consumables as long as the device is running. • Do not open the coverage as long as the device is running |

3 General Information

The homogenizing system X 120 is designed in accordance with Safety Class 2 and built and tested in accordance with DIN EN 61010.

According to these regulations the unit is designed to meet the requirements for safe and correct operations. To maintain the proper safety and operational functions of the instrument the user should follow the instructions and safety guidelines in this manual.

4 Intended Use

The X 120 is a homogenizing system which in connection with a homogenizing tool produces emulsions and dispersions. Suitable homogenizing tools are shafts T6, T10 and T17.

To ensure maximum service life, observe the specified ambient conditions (temperature and humidity) and ensure that the instrument is not exposed to a corrosive atmosphere.



⚠WARNING It is the user's task to find out whether the device is suitable for the application. If in doubt clarify this with your dealer or directly with the manufacturer.



⚠WARNING Please comply with all safety and accident-prevention regulations applicable to laboratory work.

5 Scope of delivery

Please check that the package contains the following:

| Type | Description | Part No. |
|--------------|--|-----------------------------|
| X 120 | Homogenizing System, 230 Volt Homogenizing System, 115 Volt | 60404-0000 or 60404-0001 |
| | Support Rod | 10402-0064 |
| | Instruction Manual | |

5.1 Homogenizing tools and accessories (to be ordered separately):

| Tools | Description | Part No. |
|-------------------------------------|---|------------|
| T 6 | Shaft, 6 mm diameter, 55 mm long | 60420* |
| T 6 | Shaft, 6 mm diameter, 120 mm long, | 60410* |
| T 10 | Shaft, 10 mm diameter | 60421* |
| T 17 | Shaft, 10 mm diameter, for 17 mm generator | 60426* |
| Pedestal Stand incl. rod | platform dimensions: 330x200 mm, rod diameter: 16mm, length: 690mm | 60491-0000 |
| Cross over clamp | clamp to attach the unit to a stand | 60492-0000 |
| Universal key | Universal rotor wrench for shafts 6 - 30 mm | 60470-0000 |
| Socket wrench | for all shafts | 60471-0000 |
| Rotor wrench | for shaft T 10 | 60472-0000 |

| Extensions of the Part Numbers ...-* | |
|--------------------------------------|-----------------------------|
| -0000 | Shaft without generator |
| -000F. | Shaft with generator type F |
| -000M. | Shaft with knife generator |
| -000N. | Shaft with generator type N |
| -000V. | Shaft with generator type V |

6 Setting up and Starting up the Instrument

6.1 Unpacking the Instrument

Unpack the instrument carefully and check to see that it is not damaged. It is important that any damage incurred during transport be recognized at the time of unpacking. Notify your carrier or forwarding agent immediately in case of such damage.

If the instrument is not damaged and all parts are complete you may start to operate the device after reading the instruction manual.

6.2 Setting up the Instrument



⚠ DANGER

The device may not be operated in explosion-prone areas.



⚠ WARNING

The device is not to be used without supervision.



⚠ WARNING

When connecting the instrument to an AC power outlet ensure that your local supply voltage matches the indication on the instrument.

6.3 Description Drive Unit X 120

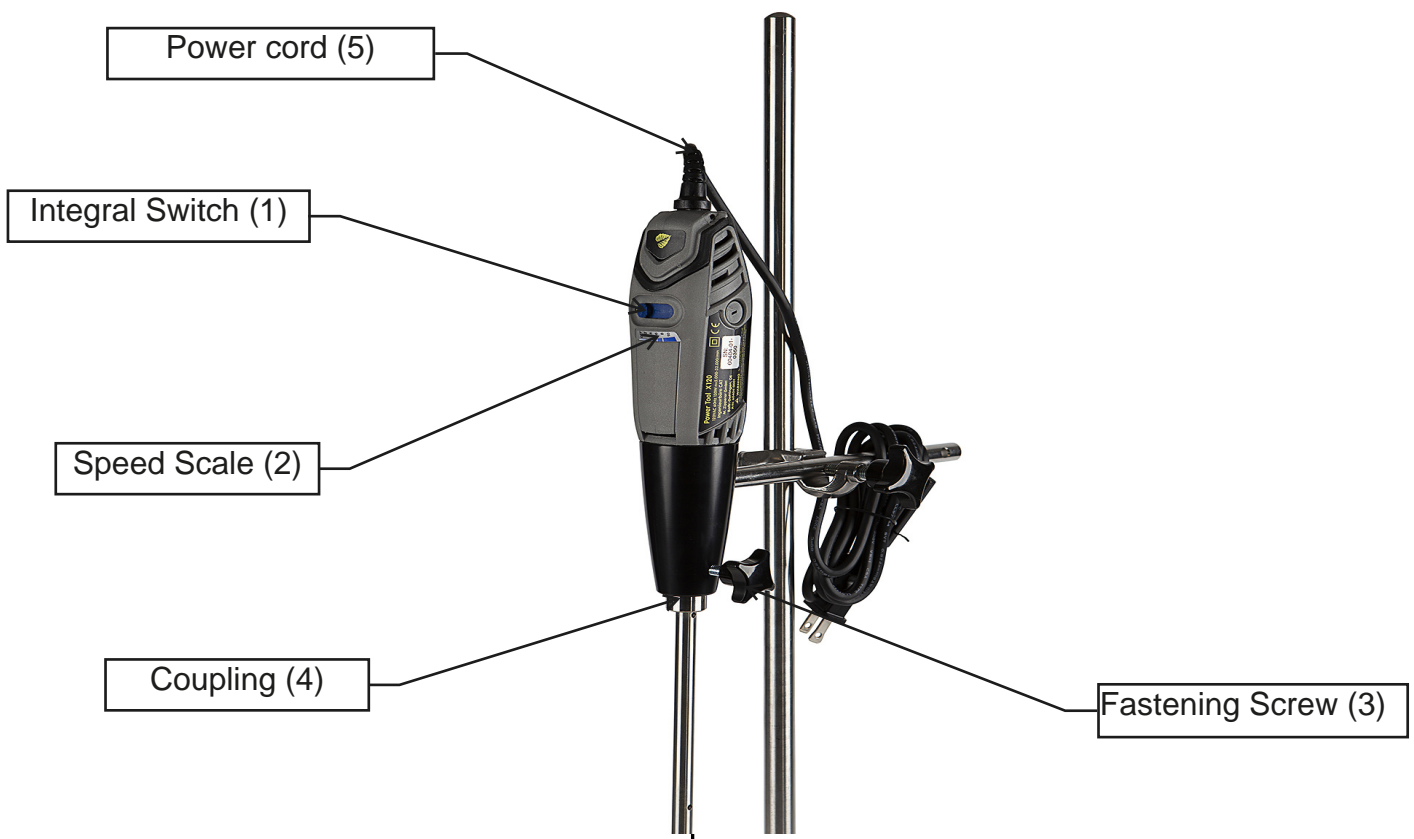

6.4 Assembly of support rod

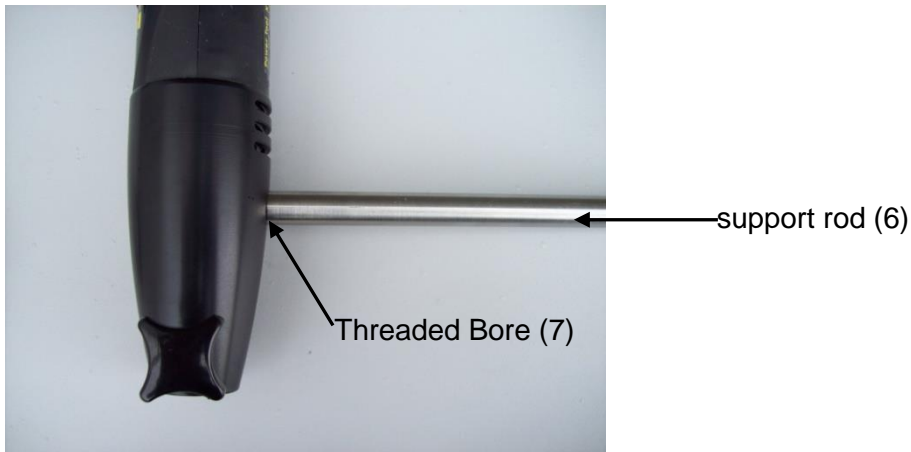

Screw the support rod (6) into the threaded bore (7) of the unit.

6.5 Attaching the drive unit to a pedestal stand

To ensure safe operation the drive units are mounted to a pedestal stand using a cross over clamp.



WARNING

Vibrations may loosen the holding screws. Please check periodically whether all holding screws are securely tight.

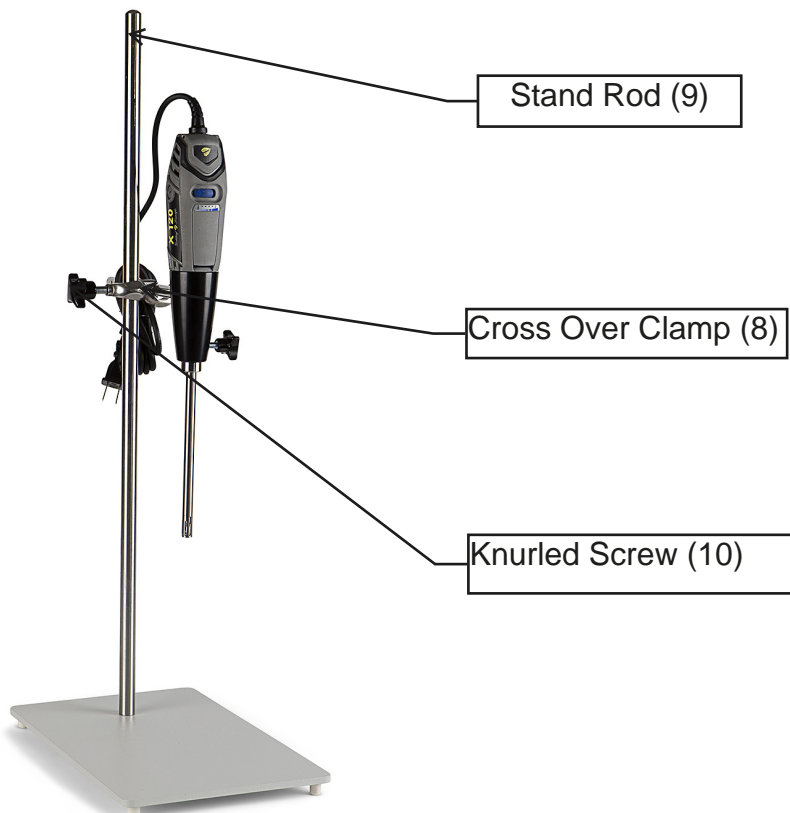

- Attach cross over clamp (8) to the stand rod (9).
- Now attach the drive unit to the stand by inserting the support rod (6) into the free opening of the cross over clamp (8).
- Tighten the knurled screw (10) of the cross over clamp (8).



cross over clamp (8)

6.6 Inserting the homogenizing tool

The homogenizing tool comes always assembled. The connecting adapter (drive pin (11)) is located on the top of the shaft and is used to attach the shaft to the drive motor. When inserting the homogenising tool, make sure that the coupling fits well. This can be easily detected by the "click" that is heard when the coupling shaft has reached the end of the coupling slot of the motor. Do not forget to securely fasten the holding screw (3).

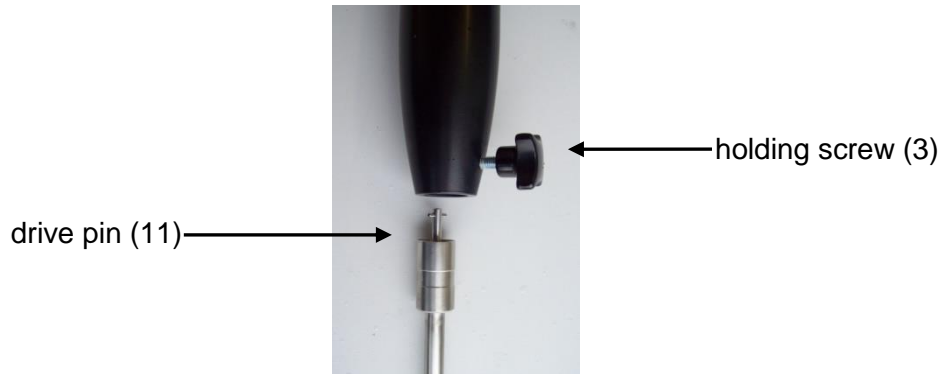

NOTICE

Never run a homogenising tool of **type I** dry as the bearings and gaskets will be damaged if the generator is not cooled by the medium. The dispersion tool must always be immersed minimum to the middle of the lower transverse bore of the shaft. The maximum immersion depth is about 3 cm below the upper transverse bore. In order not to interrupt the cooling, avoid the intake of air, or the formation of a vortex. Therefore submerge the dispersion tool deeper or eccentrically into the vessel.

The distance between the homogenising tool and the vessel bottom should not be less than 10mm.

If these conditions are met the unit is ready for operation.

6.7 Electrical Connection

WARNING ⚡

- On delivery, the units are supplied with an U.S. standard plug (NEMA 1, Type A) 10 A, 125 V.
- When operating the instruments in countries with different AC plug systems use an approved adapter or have a qualified electrician replace the AC plug with an approved model suitable for the country of operation.
- When connecting the instrument to an AC power outlet, ensure that your local supply voltage matches that indicated on the instrument's rating plate.

7 Operation X 120



▲WARNING

When connecting the instrument to an AC power outlet, ensure that your local supply voltage matches that indicated on the instrument's rating plate.

Connect the unit to the mains.

The drive unit is turned on and off by means of the integral switch (1) at the motor housing. With the integral switch (1) the speed can be steplessly adjusted.



▲WARNING

The integral switch (1) is only single-pole and is thus not suitable for safely isolating the unit from the mains supply!



▲WARNING

Before starting the unit make sure that

- the speed is set to the lowest speed
- the generator of the homogenising tool is inserted in the fluid. To avoid a vortex. It is necessary to insert the dispersing shaft out of the centre of the vessel.
- the vessel is protected against rotating, shaking or moving
- make sure that the air ventilation slots are always open, as this is necessary for cooling purposes



▲WARNING

Start the unit always at the lowest speed and then gradually increase the speed to the desired level.

NOTICE

Never exceed the maximum operation time of 3 minutes in one go. Allow motor and shaft to cool down. Disregard cause serious damage to drive unit and shaft.

7.1 Description of the speed scale X 120



▲WARNING

Start the unit always at the lowest speed and then gradually increase the speed to the desired level.

| Switch Setting | Speed Range (no load) |
|----------------|------------------------------|
| 2 | 10 000 RPM |
| 4 | 16.000 RPM |
| 6 | 22 000 RPM |
| 8 | 28 000 RPM |
| 10 | 33 000 RPM (32 000 RPM 115V) |

7.2 Exchanging the homogenizing shafts

Prior to exchange the homogenizing shaft disconnect the unit from the mains supply. Loosen the holding screw (3) and firmly pull out the shaft by hand. It will disconnect easily. When inserting another shaft, make sure that the coupling fits well. This can be easily detected by the "click" that is heard when the coupling shaft has reached the end of the coupling slot of the motor. Do not forget to securely fasten the holding screw (3).

7.3 Exchanging the generator:



WARNING

The generators have sharp edges. Handle with care. Risk of injuries!

To exchange the generator (rotor and stator), always take the shaft out of the motor drive unit as described above. For undoing the rotor, use the two special keys (to be ordered separately). The socket wrench is used to counter-hold the shaft, and the rotor wrench to undo the rotor. To exchange the stator, remember that the fastening thread is counter-clockwise. You will find further detailed descriptions in the instruction manual which comes with each homogenising tool.

NOTICE

Always unscrew the rotor first before unscrewing the stator.

8 Maintenance and Cleaning

8.1 Cleaning the drive unit X 120

To clean the drive use only water with a detergent that contains tensides or use isopropylalcohol for stubborn soiling.

8.2 Cleaning the homogenising tool



WARNING

The generators have sharp edges. Handle with care. Risk of injuries!

To avoid clogging clean shaft, generator and in case of G-shaft the sealing parts after each use. This is done by operating it in a solvent which dissolves substance residues and is not harmful to the gasket. This is usually sufficient to clean the generator.

Chemical sterilization may be also a method. General-purpose disinfectants such as formalin, alcohol, etc. may be used. It is important to remove disinfectant residues with sterilized water.

NOTICE

Make sure that the bearings, O-rings and gaskets are resistant to solvents.

Sterilization with moist heat:

This denotes the use of a steam jet pressurized to 2 bar at 120°C.

8.3 Maintenance of drive unit X 120



WARNING

Do not open the instrument. Repairs are only to be carried out by trained service technicians.

8.4 Maintenance homogenizing tools



WARNING

The generators have sharp edges. Handle with care. Risk of injuries!

The gaskets in the homogenizing tools must be constantly monitored. In the event of leakage the suction effect of the rotating shaft can cause the medium to penetrate as far as the drive unit. If liquid emerges from the side hole at the top of the shaft tube stop work immediately and check the gaskets. The function of the generators depends on the condition of the sharp edges on the rotor and stator. These edges may be blunted very quickly in abrasive media, reducing the effectiveness of homogenizing.

9 Dismantling, Transport and Storage

9.1 Dismantling

1. Switch the unit off.
2. Disconnect it from the mains supply.
3. Remove any glass beakers and any other equipment around the drive unit.
4. Remove the homogenizing tool by loosening the knurled screw (3).
5. Loosen the cross over clamp and remove the clamp from the support rod.
6. Unscrew the support rod.
7. Now you may remove the instrument from the working area.

9.2 Transport and Storage

Prior to transport:

Switch the instrument off and proceed with dismantling as described under "Dismantling".

Place the instrument and its parts in its original packaging or another suitable container to protect it during transport. Close the packaging with adhesive tape.

Store the instrument in a dry environment. Please observe the specified conditions of the ambient (temperature and humidity).

Do not subject the instrument to mechanical shocks or vibration during transporting it.

In case you do not use the original packaging please mark the box with the following notes:

- Glass symbol (handle with care, fragile)
- Umbrella (keep dry)
- Content (list of content)
- Storage ambient:
Max. ambient temperature: RT to +40°C
Max. humidity: 80%

10 Disposal



Please dispose of used instruments and defective components at your local recycling collection point. Prior to disposal, sort according to materials: metal, glass, plastic, etc. Also be sure to dispose of the packing material in an environmental-friendly manner.

11 Warranty and Liability

The manufacturer agrees to either repair, or replace, at the manufacturer's discretion, any defects in materials or workmanship which develop within 24 months of the delivery of this product to the original user. In the event of replacement, the replacement unit will be guaranteed for the remainder of the original twenty-four (24) month period or ninety (90) days, whichever is longer.

If this product should require service, contact your local distributor or manufacturer for necessary instructions.

This guarantee will not apply if the defect or malfunction was caused by accident, neglect, unreasonable use or fitness for a particular purpose, which extend beyond the description and period set forth herein.

The manufacturer's sole obligation under this guarantee is limited to the repair or replacement of a defective product and the manufacturer shall not, in any event, be liable for any incidental or consequential damages of any kind, resulting from use or possession of the product.

12 Technical Data

▲WARNING  The user has to determine, if the instrument is suitable for his specific application. If there are any further queries, contact your local dealer or the manufacturer direct.

| Type: X 120 | Specifications |
|---------------------------------|---|
| Motor Power | 130 Watt |
| Idle speed 115 V: | 5000 - 32000 rpm |
| Voltage | 230VAC (P/N 60404-0000) 115VAC (P/N 60404-0001) |
| Case dimensions | Length: 210 mm (8,268``), Diameter: 60 mm (2,362``) |
| Weight | 0,55 kg (1.21 lb) |
| Permissible ambient temperature | 5 - 40 °C |
| Permissible humidity | 80 % RH |

13 Repairs

 **▲WARNING** When returning instruments for repair that have come into contact with hazardous substances, please:

- Fill in attached "Repair Return Form"
- Provide precise information on the relevant medium
- Take protective measures to ensure the safety of our receiving and maintenance personnel
- Mark the package as appropriate for hazardous materials.

14 Repair Return Form

| |
|---------------------------------|
| CONTACT/USER INFORMATION |
|---------------------------------|

| | |
|----------|-----------|
| Contact: | Phone No. |
| Fax No. | Email: |
| Billing: | Shipping: |
| Company | Company |
| Address | Address |

| | | |
|---|--------------------|----------------|
| INSTRUMENT INFORMATION | | |
| Model | Serial No. | |
| Please describe all problems/malfunctions | | |
| Operating Conditions (please fill in if applicable) | | |
| Ambient Temp. | Humidity | Speed |
| Load | Volume | Viscosity |
| Temperature in °C | Sample Temperature | Operating Time |
| Sample Description* | | |

*NOTE: If the instrument was exposed to hazardous material, it must be decontaminated BEFORE returning it to Goldleaf Scientific and an MSDS for hazardous material must be included with the instrument.

| | | | |
|------------------------------|--|------------------------------------|----------------------------------|
| RETURN SHIPPING | | | |
| UPS <input type="checkbox"/> | Air Parcel Post <input type="checkbox"/> | Collect** <input type="checkbox"/> | Other** <input type="checkbox"/> |

**Your account number is required for UPS collect respectively the address and contact of your preferred forwarder if you choose any other transport means.

| |
|--|
| PACKAGING INSTRUCTIONS TO RETURN AN INSTRUMENT FOR REPAIR |
|--|

- ✓ Remove all accessories (e.g. homogenizer tools, stirring paddles) from the instrument
- ✓ Clean excess testing material off the instrument/accessory
- ✓ Include MSDS sheets for all hazardous materials used with this instrument
- ✓ Pack the instrument in its original box. If the box is not available, take care to wrap the instrument and accessories with enough material to support them.
- ✓ DO NOT send pedestal stand unless there is a problem with the upright rod, clamp or base. If there is a problem with the stand remove the upright rod from the base and individually wrap each item to avoid contact with the instrument. (Applicable for overhead stirrers and homogenizers.)
- ✓ Pack the instrument and related items in a strong box for shipping. Mark the outside of the box with handling instructions.

Example: "Handle with care" or "Fragile- Delicate Instrument" and send to:

Goldleaf Scientific, Service Department
3300 Harrison st suite 2
Riverside, CA 92503