



X1000 and X1000D

Homogenising System

**Instruction Manual**

---



## Content

1	User Instructions .....	5
1.1	Important Instructions for your safety .....	5
1.2	Danger symbols in this operating manual .....	5
1.2.1	Danger symbols: .....	5
1.2.2	Danger levels .....	6
1.2.3	Warning signs on the device .....	6
2	General safety warnings and instructions .....	7
3	General Information .....	9
4	Intended Use .....	9
5	Scope of delivery .....	10
5.1	Homogenising Tools and Accessories (to be ordered separately): .....	10
6	Description Drive Unit UNIDRIVE X 1000/X 1000D .....	10
7	Setting up and Starting up the Instrument .....	12
7.1	Unpacking the Instrument .....	12
7.2	Setting up the Instrument .....	12
7.3	Electrical Connection .....	12
7.4	Assembly of Support Rod .....	13
7.5	Attaching the Drive Unit to a Stand .....	14
7.6	Description of a Homogenising Tool .....	14
7.7	Inserting the Homogenizing Tool .....	15
8	Operation UNIDRIVE X 1000/X 1000D .....	16
8.1	Connect the Unit to the Mains .....	17
8.2	Description of the Speed Scale X 1000 and X 1000D: .....	17
8.3	Exchanging the Homogenizing Shafts .....	17
8.4	Exchanging the Generator: .....	17
8.5	Limits on continuous operation of the X 1000 drive unit .....	18
8.6	Overheating protection for the X 1000 drive unit .....	18
9	Maintenance and Cleaning .....	19
9.1	Cleaning the Drive Unit UNIDRIVE X 1000/X 1000D .....	19
9.2	Cleaning the Homogenising Tool .....	19
9.3	Rough Cleaning of Flow-Through-Chamber and Tubing .....	19

9.4	Cleaning the Inside of the Flow-Through-Chamber .....	19
9.5	Maintenance of drive units UNIDRIVE X 1000/X 1000D .....	20
9.6	Maintenance homogenizing tools.....	20
10	Dismantling, Transport and Storage .....	20
10.1	Dismantling.....	20
10.2	Transport and Storage .....	20
11	Disposal .....	21
12	Warranty and Liability.....	21
13	Technical Data.....	22
13.1	Technical Data UNIDRIVE X 1000/X 1000D .....	22
14	Repairs.....	22
14.1	Repair Return Form .....	23

This page is intentional left blank

# 1 User Instructions

## 1.1 Important Instructions for your safety



- Every user must read and understand this manual completely before use. Failure to do so can result in serious injury or death.
- Comply with all safety and accident-prevention regulations applicable to laboratory work.
- Follow general instructions for hazard prevention and general safety instructions, e.g. wear protection clothing, eye protection and gloves.
- This operating manual is part of the product. Thus, it must always be easily accessible.
- This instruction sheet does not purport to address all of the safety problems which might result from the use of this device, chemicals, reagents, apparatus or equipment employed in any specific test or protocols. It is the responsibility of the user to consult their authorized safety advisors and establish appropriate health and safety practices and then determine the application of regulatory limitations prior to use.
- Enclose this operating manual when transferring the device to another place.
- If this manual is lost, please request another one. Please contact your dealer or



### Goldleaf Scientific LLC









30042 Mission BLVD. STE. 121 #193  
Hayward, CA 94544  
(510)487-1390  
[www.Goldleaflabs.com](http://www.Goldleaflabs.com)  
[support@goldleaflabs.com](mailto:support@goldleaflabs.com)

## 1.2 Danger symbols in this operating manual

The safety instructions in this manual appear with the following danger symbols and danger levels:

### 1.2.1 Danger symbols:





	<b>Hazard point</b>		<b>Electrical shock</b>
---	---------------------	---	-------------------------

 Risk of fire	 Explosion
 Crushing	 Hot surface
 Bio hazard	 Magnetic field
 Chemical hazard	 Material damage





### 1.2.2 Danger levels





<b>▲ DANGER</b>	Will lead to severe injuries or death
<b>▲ WARNING</b>	May lead to severe injuries or death
<b>▲ CAUTION</b>	May lead to light to moderate injuries
<b>NOTICE</b>	May lead to material damage

### 1.2.3 Warning signs on the device



 	<p><b>▲ WARNING</b> These symbols indicate that it is imperative to read and understand the instruction manual prior to operating the instrument. Please highlight points which require special attention in your field of application so they are not overlooked. Disregard of warnings may result in impairment of serviceability as well as in physical harm to the user.</p>
  	<p><b>▲ WARNING</b> These symbols indicate that it is imperative to wear eye and ear protection to avoid damage to health</p>

## 2 General safety warnings and instructions

	<p><b>⚠ DANGER Risk of explosion.</b></p> <ul style="list-style-type: none"> <li>• Do not operate the device in the vicinity of highly flammable or explosive substances. The instrument is not explosion-proof.</li> <li>• Do not use this device for processing any substances which could generate an explosive atmosphere.</li> <li>• Do not use this device to process any explosive or highly reactive substances.</li> <li>• Do not use flammable or explosive substances near the instrument.</li> </ul>
	<p><b>⚠ DANGER Electric shock as a result of penetration of liquid.</b></p> <ul style="list-style-type: none"> <li>• Do not allow any liquids to penetrate the inside of the housing</li> <li>• Switch off the device and disconnect the power plug before starting cleaning or disinfection work. The On/Off Switch on the device does not disconnect the device from the power source.</li> <li>• Use only closed tubes.</li> <li>• Only plug the device back in if it is completely dry, both inside and outside.</li> </ul>
	<p><b>Risk from incorrect supply voltage</b></p> <ul style="list-style-type: none"> <li>• Only connect the device to voltage sources which correspondent to the electrical requirements on the type label.</li> </ul>
	<p><b>⚠ WARNING Electric shock due to damage to device or mains cable</b></p> <ul style="list-style-type: none"> <li>• Only connect the device to the mains supply if the device and the mains cable are undamaged</li> <li>• Only use devices that have been properly installed or repaired.</li> <li>• In case of danger, disconnect the device from the mains supply by pulling the power plug from the mains socket or by using the isolating device intended for this purpose (e.g. emergency stop switch)</li> </ul>
	<p><b>⚠ WARNING Lethal voltage inside the device</b></p> <ul style="list-style-type: none"> <li>• Do not open the device.</li> <li>• Ensure that the housing is always closed and undamaged so that no parts inside the housing can be contacted by accident.</li> <li>• The On/Off Switch on the device does not disconnect the device from the power source. Remove the plug from the AC power outlet to disconnect the instrument from the mains supply entirely.</li> <li>• Do not allow any liquids to penetrate the inside of the housing.</li> <li>• Repairs are only to be carried out by trained service technicians.</li> </ul>

	<p><b>▲WARNING</b> <b>Damage to health due to corrosive or aggressive chemicals</b></p> <ul style="list-style-type: none"> <li>● Observe all markings on the reagent bottles.</li> <li>● Always check the instrument that all push-ons and threaded connections are firmly in place before beginning operation.</li> <li>● Use proper connecting vessels, protective clothing and gloves.</li> <li>● Avoid splashes</li> <li>● When dispensing, maintain a physical distance between the instrument and the body.</li> <li>● Dangerous and fuming chemicals must be dispensed in a fume hood.</li> <li>● Only employ the instrument for the purpose intended by the manufacturer, and particularly within the resistance limits of the instrument. If in doubt, contact your supplier, or the manufacturer's factory representative at the phone number shown at the front page of this operating instruction.</li> <li>● Always use the instrument in such a manner that neither the operator, nor any other person is endangered.</li> </ul>
	<p><b>▲WARNING</b> <b>Damages to health due to infectious liquids and pathogenic germs.</b></p> <ul style="list-style-type: none"> <li>● When handling infectious liquids and pathogenic germs, observe the national regulations, the biological security level of your laboratory, the material safety data sheets and the manufacturer's application notes.</li> <li>● Wear personal protective equipment</li> <li>● For comprehensive regulations about handling germs or biological material of the risk group II or higher, please refer to the "Laboratory Biosafety Manual" in its respectively current valid version from the World Health Organisation</li> </ul>
	<p><b>▲WARNING</b> <b>Damage to health due to contaminated device and accessories</b></p> <p>In the following cases, sample material can be released:</p> <ul style="list-style-type: none"> <li>- improperly sealed tubes</li> <li>- unstable tubes</li> <li>- high vapour pressure of the content so that the seal of the tubes can spring open</li> <li>- damaged sealings</li> <li>- smashed glass tubes</li> </ul> <ul style="list-style-type: none"> <li>● Only mix in closed tubes</li> <li>● Observe the nationally prescribed safety environment when working with hazardous, toxic and pathogenic samples. Pay particular attention to personal protective equipment (gloves, clothing, goggles, etc.), extraction, and the safety class of the lab.</li> <li>● Decontaminate the device and the accessories before storage and shipping.</li> </ul>
	<p><b>▲WARNING</b> <b>Risk of fire</b></p> <ul style="list-style-type: none"> <li>● Do not use this device to process any highly flammable liquids</li> </ul>



	<p><b>▲CAUTION</b> <b>Poor safety due to inadequate fixing of the unit</b></p> <ul style="list-style-type: none"> <li>• Ensure that the unit is firmly attached to a solid stand.</li> </ul>
	<p><b>▲CAUTION</b> <b>Poor safety due to incorrect accessories and spare parts.</b></p> <p>The use of accessories and spare parts other than recommended by Goldleaf Scientific may impair the safety, function and precision of the device. Goldleaf Scientific cannot be held liable or accept any liability for damage resulting from the use of incorrect or non-recommended accessories and spare parts, or from the improper use of such equipment.</p> <ul style="list-style-type: none"> <li>• Only use accessories and spare parts recommended by Goldleaf Scientific</li> </ul>
	<p><b>▲CAUTION</b> <b>Crush hazard due to moving parts</b></p> <ul style="list-style-type: none"> <li>• Do not replace any consumables as long as the device is running.</li> <li>• Do not open the coverage as long as the device is running</li> </ul>

### 3 General Information



The homogeniser Unidrive X 1000/Unidrive X 1000D is designed in accordance with Safety Class 1 and built and tested in accordance with DIN EN 61010.

According to these regulations the unit is designed to meet the requirements for safe and correct operations. To maintain the proper safety and operational functions of the instrument the user should follow the instructions and safety guidelines in this manual.

### 4 Intended Use

The UNIDRIVE X 1000/X 1000D is a homogenizing system which in connection with a homogenizing tool produces emulsions and dispersions. For safe operation the unit has to be fixed to a stand.

To ensure maximum service life, observe the specified ambient conditions (temperature and humidity) and ensure that the instrument is not exposed to a corrosive atmosphere.

	<p><b>▲WARNING</b> It is the user's task to find out whether the device is suitable for the application. If in doubt clarify this with your dealer or directly with the manufacturer.</p>
	<p><b>▲WARNING</b> Please comply with all safety and accident-prevention regulations applicable to laboratory work.</p>

## 5 Scope of delivery

Please check that the package contains the following:

Type	Description	Part No.
X 1000	Homogenizing Drive Unit, 230V	60402-0050 or
X 1000	Homogenizing Drive Unit, 115V	60402-0051 or
X 1000D	Homogenizing Drive Unit, 230V	60406-0050 or
X 1000D	Homogenizing Drive Unit, 115V	60406-0051 or
	1 Support Rod	
	1 Instruction Manual	

### 5.1 Homogenising Tools and Accessories (to be ordered separately):

	T 6	T 6 long	T 10	T 17	T 20	G 20
	 <b>2,0 - 50 ml</b> 55 mm   120 mm		 <b>10,0 - 250 ml</b> 150 mm	 <b>250 - 1500 ml</b> 150 mm	 <b>250 - 5000 ml</b> 200 mm   215 mm	
<b>fine F</b>						
<b>low viscosity N</b>						
<b>viscous V</b>						
<b>knife M</b>						

**T = Shaft with PTFE bearing.** This shaft type is used for standard application. (For liquid media like water, oil, etc.)

The bearing must be cooled by the media, *which penetrates into the bearing.*  
*A dry run is not permitted.*

**G = Shaft with slide seal ring.** This shaft type is excellent for applications with aggressive respectively abrasive media and when pressure is applied. *Also suitable for use with solids.*

*The bearing is sealed and suitable for dry running*

Tool	Description	Part No.
<b>Pedestal stand incl. rod</b>	platform overall dimensions: 330x200 mm, rod diameter: 16mm, length:690mm	60491-0000
<b>Cross over clamp</b>	Casted alloy clamp to attach the unit to a stand	60492-0000
<b>Cross over clamp</b>	Steel clamp to attach the unit to a stand	60492-0050
<b>Universal key</b>	Universal rotor wrench for Shafts 6 - 30 mm	60470-0000
<b>Socket wrench</b>	for all shafts	60471-0000
<b>Rotor wrench</b>	for shaft T 10	60472-0000

## 6 Description Drive Unit UNIDRIVE X 1000/X 1000D

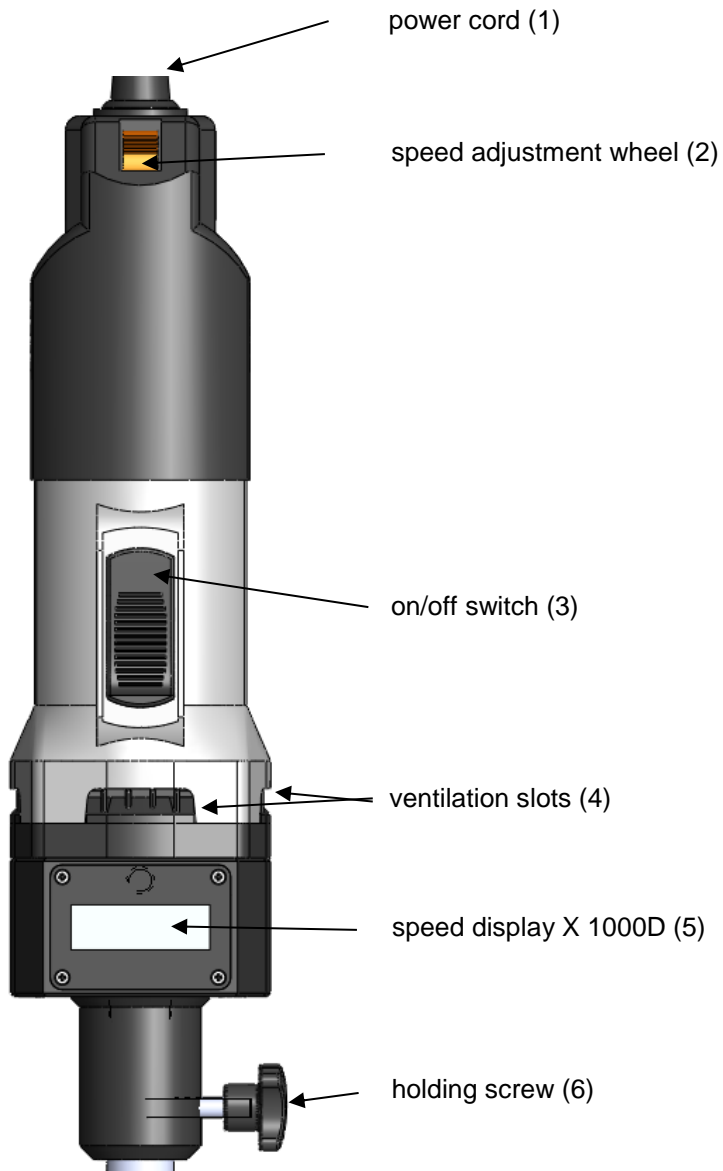



## 7 Setting up and Starting up the Instrument

### 7.1 Unpacking the Instrument

Unpack the instrument carefully and check to see that it is not damaged. It is important that any damage incurred during transport be recognized at the time of unpacking. Notify your carrier or forwarding agent immediately in case of such damage.

If the instrument is not damaged and all parts are complete you may start to operate the device after reading the instruction manual.

### 7.2 Setting up the Instrument

	<b>▲ DANGER</b> The device may not be operated in explosion-prone areas.
	<b>▲ WARNING</b> The device is not to be used without supervision.
	<b>▲ WARNING</b> When connecting the instrument to an AC power outlet ensure that your local supply voltage matches the indication on the instrument.

### 7.3 Electrical Connection

**▲ WARNING** 

- On delivery, the units are supplied with a Euro plug EN 50075:1990, 2.5 A, 250 V. For North America, with a U.S. standard plug (NEMA 1, Type A) 10 A, 125 V.
- When operating the instruments in countries with different AC plug systems use an approved adapter or have a qualified electrician replace the AC plug with an approved model suitable for the country of operation.
- When connecting the instrument to an AC power outlet, ensure that your local supply voltage matches that indicated on the instrument's rating plate.

## 7.4 Assembly of Support Rod

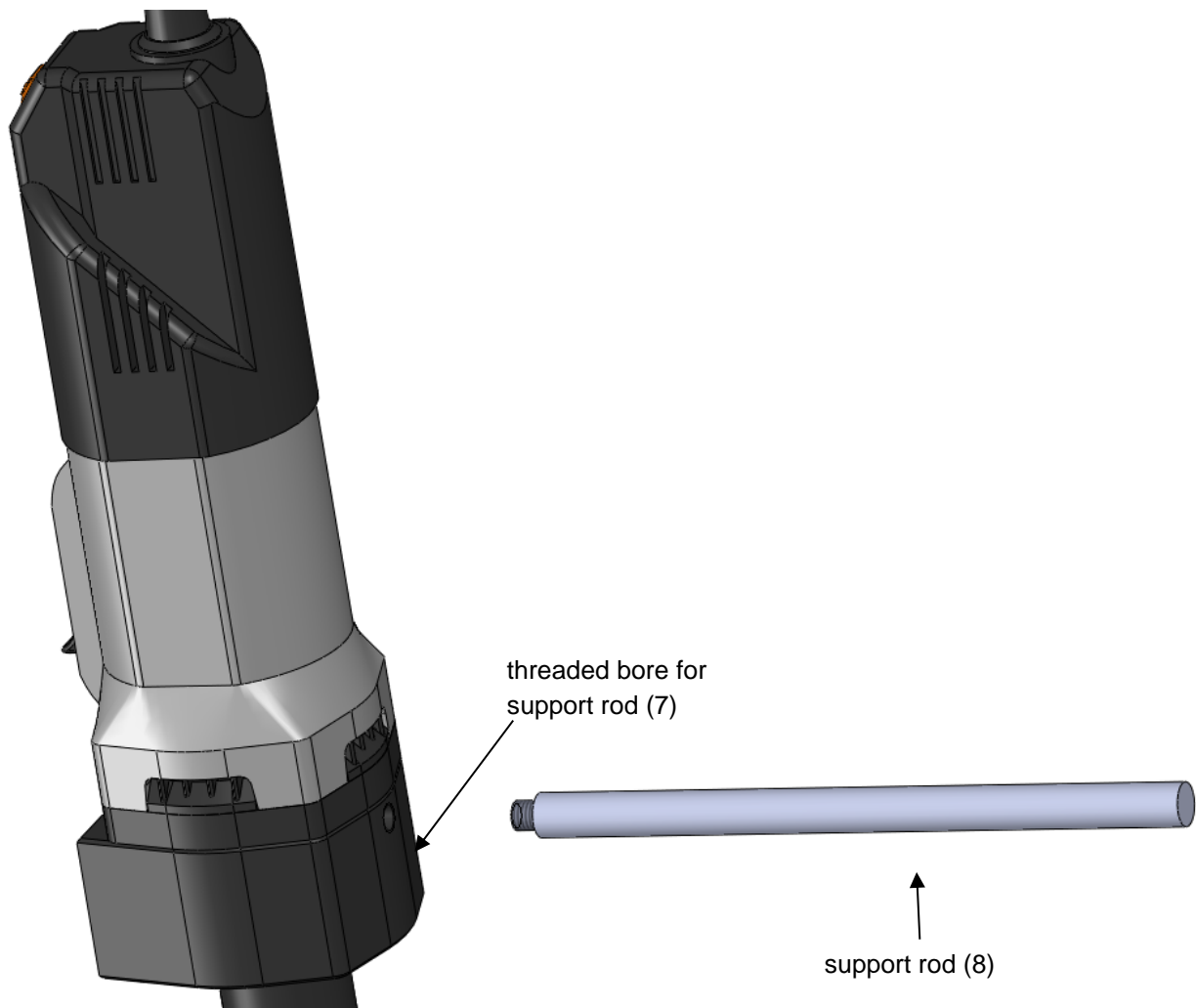

- Screw the support rod (8) into the threaded bore (7) at the back of the unit.
- Insert a screw driver into the bore at the end of the support rod (8) and firmly tighten the support rod by turning the screw driver to the right.

## 7.5 Attaching the Drive Unit to a Stand



### **WARNING**

To ensure safe operation the drive units are mounted to a pedestal stand using a cross over clamp. Vibrations may loosen the holding screws. Please check periodically whether all holding screws are securely tight

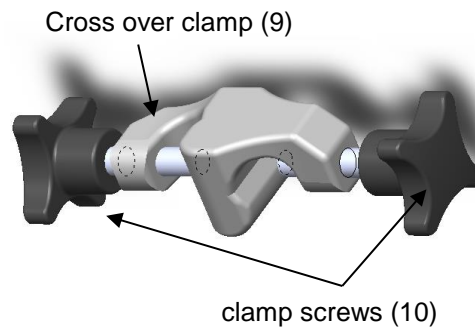

- Attach cross over clamp (9) to a stand rod.
- Now attach the drive unit to the stand by inserting the support rod (8) into the free opening of the cross over clamp (9).
- Tighten screws (10) of the cross over clamp (9).

## 7.6 Description of a Homogenising Tool

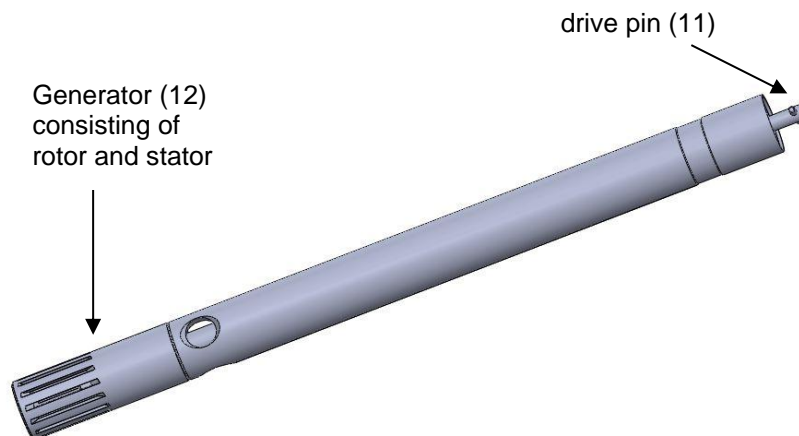

## 7.7 Inserting the Homogenizing Tool

	<b>WARNING</b>	The generators have sharp edges. Handle with care. Risk of injuries!
---	----------------	--

The homogenizing tool comes always assembled. The connecting adapter (drive pin (11)) is located on the top of the Shaft and is used to attach the Shaft to the drive motor. When inserting the homogenising tool, make sure that the coupling fits well. This can be easily detected by the "click" that is heard when the coupling Shaft has reached the end of the coupling slot of the motor. Securely fasten the holding screw (6).

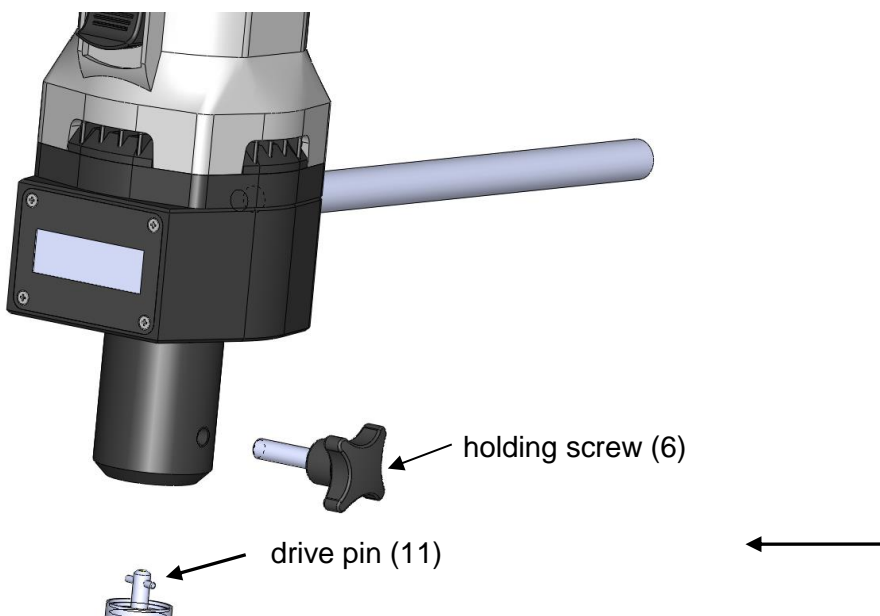

**NOTICE** Never run homogenising tools dry as the bearings and gaskets will be damaged if the generator is not cooled by the medium. The distance between the homogenising tool and the vessel bottom should not be less than 10mm. The filling of the medium may not be less than about 55 mm. To avoid a vortex it is necessary to insert the dispersing shaft out of the centre of the vessel. If these conditions are met the unit is ready for operation.

## 8 Operation UNIDRIVE X 1000/X 1000D

	<b>WARNING</b> When connecting the instrument to an AC power outlet, ensure that your local supply voltage matches that indicated on the instrument's rating plate.
---	---

Connect the unit to the mains.

The drive unit is turned on and off by means of the integral switch (1) at the motor housing. With the integral switch (1) the speed can be steplessly adjusted.



**WARNING** The integral switch (1) is only single-pole and is thus not suitable for safely isolating the unit from the mains supply!



**WARNING** Before starting the unit make sure that

- the speed is set to the lowest speed
- the generator of the homogenising tool is inserted in the fluid. To avoid a vortex. it is necessary to insert the dispersing shaft out of the centre of the vessel.
- the vessel is protected against rotating, shaking or moving
- make sure that the air ventilation slots are always open, as this is necessary for cooling purposes



**WARNING** Start the unit always at the lowest speed and then gradually increase the speed to the desired level.

**NOTICE** Never exceed the maximum operation time of 3 minutes in one go. Allow motor and shaft to cool down. Disregard cause serious damage to drive unit and shaft.

	<b>NOTICE</b> The UNIDRIVE X 1000/X 1000D has an internal thermal overload protection which switches off the instrument to protect the motor. Before restart the unit wait for minimum 10 min. to let the motor cool down.
--	---



## 8.1 Connect the Unit to the Mains.

The drive unit is turned on and off by means of the on/off switch (3) at the front of the motor housing.

position I: motor runs

position 0: motor off

Set the speed with the speed adjustment wheel (2).

	<b>▲WARNING</b> The on/off switch (3) is only single-pole and is thus not suitable for safely isolating the unit from the mains supply!
---	---

*Before starting the unit make sure that*

- the speed is set to the lowest speed
- the Generator (12) of the homogenising tool is inserted in the fluid. To avoid a vortex it is necessary to insert the dispersing Shaft out of the centre of the vessel.
- the vessel is protected against rotating, shaking or moving
- make sure that the air ventilation slots (4) are always open, as this is necessary for cooling purposes

Start the unit always at the lowest speed and then gradually increase the speed to the desired level.

## 8.2 Description of the Speed Scale X 1000 and X 1000D:

1	=	4000 rpm
2	=	8500 rpm
3	=	15000 rpm
4	=	20000 rpm
5	=	25000 rpm
6	=	33000 rpm

The set speed of UNIDRIVE X 1000D is shown the speed display (5).

## 8.3 Exchanging the Homogenizing Shafts

- Prior to exchange the homogenizing shaft disconnect the unit from the mains supply by unplugging the unit.
- Loosen the holding screw (6) and firmly pull out the Shaft by hand. It will disconnect easily.
- When inserting another Shaft, make sure that the coupling fits well. This can be easily detected by the "click" that is heard when the coupling Shaft has reached the end of the coupling slot of the motor.
- Securely fasten the holding screw (6).

## 8.4 Exchanging the Generator:

	<b>▲WARNING</b> The generators have sharp edges. Handle with care. Risk of injuries!
---	--

To exchange the Generator (rotor and stator), always take the Shaft out of the motor drive unit as described under 4.6.

For undoing the rotor, use the two special keys (to be ordered separately). The socket wrench is used to counter-hold the Shaft, and the rotor wrench to undo the rotor.

To exchange the stator, remember that the fastening thread is **counter-clockwise**.

You will find further detailed descriptions in the instruction manual which comes with each homogenising tool.

**NOTICE**

Always unscrew the rotor first before unscrewing the stator.

### 8.5 Limits on continuous operation of the X 1000 drive unit

In combination with the shafts T6, T10, T17 and T/G20 the X 1000 drive unit can be used in continuous operation.

### 8.6 Overheating protection for the X 1000 drive unit

The X 1000 drive unit features a safety electronic (temperature-dependent overload protection), which prevent the unit from overheating by enabling a cooling mode as soon as the drive reaches the critical temperature.

In that cooling mode the constant-electronic is deactivated and the drive unit is running at a very low speed. After a cooling time of 60 seconds, the machine is ready for operation. Therefore, switch off and on the device to activate the constant-electronic. Before switching on the device, ensure that the lowest rpm-level is set to prevent the media from splashing out of the container. The speed can then be raised step-by-step.



**NOTICE**

When the overheating of the drive unit occurs several times in a row, we recommend extending the duration of the cooling-phase significantly to avoid permanent damage to the device.

Whether and in what time the engine may overheat depends on the rated input and the present self-cooling power of the drive unit. The rated input of the system is determined by the following factors:

- Set speed
- Tool size and tool design
- Condition of the medium to be processed (such as: viscosity, temperature, volume, inclusions of air or solids, etc.)

Intensified conditions (e.g. higher ambient temperature, fluid temperature or differing viscosity levels) can shift the time of overheating of the drive unit. Therefore, careful handling of the X 1000 drive unit is fundamental!

## 9 Maintenance and Cleaning

### 9.1 Cleaning the Drive Unit UNIDRIVE X 1000/X 1000D

To clean the drive unit use only water with a detergent that contains tensides or use isopropyl alcohol for stubborn soiling.

### 9.2 Cleaning the Homogenising Tool

	<b>WARNING</b> The generators have sharp edges. Handle with care. Risk of injuries!
---	---

To avoid clogging of the shaft, clean shaft, generator and in case of G-shaft the sealing parts after each use. This is done by operating it in a solvent which dissolves substance residues and is not harmful to the gasket. This is usually sufficient to clean the Generator.

**Chemical sterilization** may be also a method. General-purpose disinfectants such as formalin, alcohol, etc. may be used. It is important to remove disinfectant residues with sterilized water.

**NOTICE** Make sure that the bearings, O-rings and gaskets are resistant to solvents.

#### **Sterilization with moist heat:**

This denotes the use of a steam jet pressurized to 2 bars at 120°C.

### 9.3 Rough Cleaning of Flow-Through-Chamber and Tubing

Flow-through-chamber and tubing might be roughly cleaned by pumping a suitable liquid through the chamber instead of the medium.

### 9.4 Cleaning the Inside of the Flow-Through-Chamber

Before cleaning please disconnect first drive unit from mains and detach the flow through chamber DK 30

The flow-through chamber can be disassembled without disconnecting the tubes. **Attention:** Rest liquid escapes!!!

Please take care that neither O-rings nor any other parts experience any damage during assembling respectively disassembling the flow-through chamber.

Before operation check the slip ring sealing. The slip ring should be easily turned by hand. If it is stuck after a long period without use just loosen slip ring by wetting it with water. Never operate the flow-through chamber if the slip ring is stuck!!

**NOTICE** Always unscrew the rotor before the stator.

**Note:** Rotor and stator wrenches are listed in the price list under accessories.

## 9.5 Maintenance of drive units UNIDRIVE X 1000/X 1000D



### **▲WARNING**

Do not open the instrument. Repairs are only to be carried out by trained service technicians.

## 9.6 Maintenance homogenizing tools



### **▲WARNING**

The generators have sharp edges. Handle with care. Risk of injuries!

The gaskets in the homogenizing tools must be constantly monitored. In the event of leakage the suction effect of the rotating Shaft can cause the medium to penetrate as far as the drive unit. If liquid emerges from the side hole at the top of the Shaft tube stop work immediately and check the gaskets. The function of the Generators depends on the condition of the sharp edges on the rotor and stator. These edges may be blunted very quickly in abrasive media, reducing the effectiveness of homogenizing.

## 10 Dismantling, Transport and Storage

### 10.1 Dismantling

1. Switch the unit off.
2. Disconnect it from the mains supply.
3. Remove any glass beakers and any other equipment around the drive unit.
4. Remove the homogenizing tool by loosening the holding screw (6).
5. Loosen the special clamp and remove the clamp from the support rod.
6. Unscrew the support rod.
7. Now you may remove the instrument from the working area.

### 10.2 Transport and Storage

#### **Prior to transport:**

Switch the instrument off and proceed with dismantling as described under “Dismantling”.

Place the instrument and its parts in its original packaging or another suitable container to protect it during transport. Close the packaging with adhesive tape.

Store the instrument in a dry environment. Please observe the specified conditions of the ambient (temperature and humidity).

Do not subject the instrument to mechanical shocks or vibration during transporting it.

In case you do not use the original packaging please mark the box with the following notes:

- Glass symbol (handle with care, fragile)
- Umbrella (keep dry)
- Content (list of content)
- Storage ambient:

Max. ambient temperature : RT to +40°C

Max. humidity: 80%

## 11 Disposal



Please dispose of used instruments and defective components at your local recycling collection point. Prior to disposal, sort according to materials: Metal, glass, plastic, etc. Also be sure to dispose of the packing material in an environmental-friendly manner.

## 12 Warranty and Liability

The manufacturer agrees to either repair, or replace, at the manufacturer's discretion, any defects in materials or workmanship which develop within 24 months of the delivery of this product to the original user. In the event of replacement, the replacement unit will be guaranteed for the remainder of the original twenty-four (24) months period or ninety (90) days, whichever is longer.

If this product should require service, contact your local distributor or manufacturer for necessary instructions.

This guarantee will not apply if the defect or malfunction was caused by accident, neglect, unreasonable use or fitness for a particular purpose, which extend beyond the description and period set forth herein.

The manufacturer's sole obligation under this guarantee is limited to the repair or replacement of a defective product and the manufacturer shall not, in any event, be liable for any incidental or consequential damages of any kind, resulting from use or possession of the product.



### **▲WARNING**

The user has to determine, if the instrument is suitable for his specific application. If there are any further queries, contact your local dealer or the manufacturer direct.

## 13 Technical Data

### 13.1 Technical Data UNIDRIVE X 1000/X 1000D

Type: UNIDRIVE X 1000	Specifications
Motor Power intake	1050 Watt
Motor Power output	650 Watt
Idle speed	4000 - 33000 rpm
Voltage	230V/50 Hz or 115V/60 Hz
Case dimensions	75x75x290 mm, WxDxH
Speed Display	-
Weight	2.1 kg
Permissible ambient temperature	5 - 40 °C
Permissible humidity	80 % RH

Type: UNIDRIVE X 1000D	Specifications
Motor Power intake	1050 Watt
Motor Power output	650 Watt
Idle speed	4000 - 33000 rpm
Voltage	230V/50 Hz or 115V/60 Hz
Case dimensions	75x75 x 300 mm, WxDxH
Speed Display	Yes
Weight	2.3 kg
Permissible ambient temperature	5 - 40 °C
Permissible humidity	80 % RH

## 14 Repairs

	<p><b>▲WARNING</b> When returning instruments for repair that have come into contact with hazardous substances, please:</p> <p>Fill in attached "Repair Return Form"</p> <p>Provide precise information on the relevant medium</p> <p>Take protective measures to ensure the safety of our receiving and maintenance personnel</p> <p>Mark the package as appropriate for hazardous materials.</p>
---	--

## 14.1 Repair Return Form

<b>CONTACT/USER INFORMATION</b>
---------------------------------

Contact:	Phone No.
Fax No.	Email:
Billing:	Shipping:
Company	Company
Address	Address

<b>INSTRUMENT INFORMATION</b>		
Model	Serial No.	
Please describe all problems/malfunctions		
Operating Conditions (please fill in if applicable)		
Ambient Temp.	Humidity	Speed
Load	Volume	Viscosity
Temperature in °C	Sample Temperature	Operating Time
Sample Description*		

\*NOTE: If the instrument was exposed to hazardous material, it must be decontaminated BEFORE returning it to Goldleaf Scientific and an MSDS for hazardous material must be included with the instrument.

<b>RETURN SHIPPING</b>			
UPS <input type="checkbox"/>	Air Parcel Post <input type="checkbox"/>	Collect** <input type="checkbox"/>	Other** <input type="checkbox"/>

\*\*Your account number is required for UPS collect respectively the address and contact of your preferred forwarder if you choose any other transport means.

<b>PACKAGING INSTRUCTIONS TO RETURN AN INSTRUMENT FOR REPAIR</b>
--

- ✓ Remove all accessories (e.g. homogeniser tools, stirring paddles) from the instrument
- ✓ Clean excess testing material off the instrument/accessory
- ✓ Include MSDS sheets for all hazardous materials used with this instrument
- ✓ Pack the instrument in its original box. If the box is not available, take care to wrap the instrument and accessories with enough material to support them.
- ✓ DO NOT send pedestal stand unless there is a problem with the upright rod, clamp or base. If there is a problem with the stand remove the upright rod from the base and individually wrap each item to avoid contact with the instrument. (Applicable for overhead stirrers and homogenisers.)
- ✓ Pack the instrument and related items in a strong box for shipping. Mark the outside of the box with handling instructions.  
Example: "Handle with care" or "Fragile- Delicate Instrument"