

Manual Gazelle with Bosch Active Line (plus) system



Bicycle Owner's Manual

11th Edition, 2015

This manual meets ISO-4210, 16 CFR 1512 and EN 14764, 14766 and 14781 Standards

IMPORTANT:

This manual contains important safety, performance and service information. Read it completely before you take the first ride on your new bicycle, and keep it for reference.

Additional safety, performance and service information for specific components such as suspension or pedals on your bicycle, or for accessories such as helmets or lights that you purchase, may also be available. Make sure that your dealer has given you all the manufacturers' literature that was included with your bicycle or accessories. In case of a conflict between the instructions in this manual and information provided by a component manufacturer, always follow the component manufacturer's instructions. You must also read the bpsa manual delivered with this bike.

If you purchased a pedelec, please carefully read the complete original user manual of the pedelec too!

If you have any questions or do not understand something, take responsibility for your safety and consult with your dealer or the bicycle's manufacturer.

NOTE:

This manual is not intended as a comprehensive use, service, repair or maintenance manual. Please see your dealer for all service, repairs or maintenance. Your dealer may also be able to refer you to classes, clinics or books on bicycle use, service, repair or maintenance.

This manual is not intended as a guide to learn how to ride a bicycle or a pedelec.



Contents

GENERAL WARNING	p. 4
A special note to parents	p. 5
1. First	
A. Bike fit	p. 6
B. Safety first	p. 6
C. Mechanical Safety Check	p. 6
D. First ride	p. 7
2. Safety	
A. The Basics	p. 8
B. Riding Safety	p. 8
C. Off Road Safety	p. 9
D. Wet Weather Riding	p. 9
E. Night Riding	p. 9
F. Extreme, stunt or competition riding	p. 10
G. Changing Components or Adding Accessories	p. 10
3. Fit	
A. Standover height	p. 11
B. Saddle position	p. 11
C. Handlebar height and angle	p. 13
D. Control position adjustments	p. 13
E. Brake reach	p. 13
4. Tech	
A. Wheels	p. 13
1. secondary retention devices	p. 14
2. Wheels with cam action systems	p. 15
3. Removing and installing wheels	p. 15
B. Seat post cam action clamp	p. 17
C. Brakes	p. 17
D. Shifting gears	p. 18
E. Pedals	p. 20
F. Bicycle Suspension	p. 21
G. Tires and Tubes	p. 21
5. Service	
A. Service Intervals	p. 23
B. If your bicycle sustains an impact	p. 24
Appendix A: Intended Use	p. 24
Appendix B: Lifespan of your bike and its components	p. 28
Appendix C: Coaster Brakes	p. 32
Appendix D: Fastener Torque Specifications	p. 33

GENERAL WARNING:

Like any sport, bicycling involves risk of injury and damage. By choosing to ride a bicycle, you assume the responsibility for that risk, so you need to know — and to practice — the rules of safe and responsible riding and of proper use and maintenance. Proper use and maintenance of your bicycle reduces risk of injury.

This Manual contains many “Warnings” and “Cautions” concerning the consequences of failure to maintain or inspect your bicycle and of failure to follow safe cycling practices.

- The combination of the  safety alert symbol and the word **WARNING** indicates a potentially hazardous situation which, if not avoided, could result in serious injury or death.
- The combination of the  safety alert symbol and the word **CAUTION** indicates a potentially hazardous situation which, if not avoided, may result in minor or moderate injury, or is an alert against unsafe practices.
- The word **CAUTION** used without the safety alert symbol indicates a situation which, if not avoided, could result in serious damage to the bicycle or the voiding of your warranty.

Many of the Warnings and Cautions say “you may lose control and fall”. Because any fall can result in serious injury or even death, we do not always repeat the warning of possible injury or death.

Because it is impossible to anticipate every situation or condition which can occur while riding, this Manual makes no representation about the safe use of the bicycle under all conditions. There are risks associated with the use of any bicycle which cannot be predicted or avoided, and which are the sole responsibility of the rider.

A special note for parents:



WARNING: This manual does not cover children's bikes, juvenile or BMX bicycles.

As a parent or guardian, you are responsible for the activities and safety of your minor child, and that includes making sure that the bicycle is properly fitted to the child; that it is in good repair and safe operating condition; that you and your child have learned and understand the safe operation of the bicycle; and that you and your child have learned, understood and obeyed not only the applicable local motor vehicle, bicycle and traffic laws, but also the common sense rules of safe and responsible bicycling. As a parent, you should read this manual, as well as review its warnings and the bicycle's functions and operating procedures with your child, before letting your child ride the bicycle.



WARNING: Make sure that your child always wears an approved bicycle helmet when riding; but also make sure that your child understands that a bicycle helmet is for bicycling only, and must be removed when not riding. A helmet must not be worn while playing, in play areas, on playground equipment, while climbing trees, or at any time while not riding a bicycle. Failure to follow this warning could result in serious injury or death.

1. First

NOTE: We strongly urge you to read this manual in its entirety before your first ride. At the very least, read and make sure that you understand each point in this section, and refer to the cited sections on any issue which you don't completely understand. Please note that not all bicycles have all of the features described in this manual. Ask your dealer to point out the features of your bicycle.

A. Bike fit

1. Is your bike the right size? To check, see Section 3.A. If your bicycle is too large or too small for you, you may lose control and fall. If your new bike is not the right size, ask your dealer to exchange it before you ride it.

2. Is the saddle at the right height? To check, see Section 3.B. If you adjust your saddle height, follow the Minimum Insertion instructions in Section 3.B.

3. Are saddle and seat post securely clamped? A correctly tightened saddle will allow no saddle movement in any direction. See Section 3.B.

4. Are the stem and handlebars at the right height for you? If not, see Section 3.C.

5. Can you comfortably operate the brakes? If not, you may be able to adjust their angle and reach. See Section 3.D and 3.E.

6. Do you fully understand how to operate your new bicycle? If not, before your first ride, have your dealer explain any functions or features which you do not understand.

B. Safety first

1. Always wear an approved and correct fitting helmet when riding your bike, and follow the helmet manufacturer's instructions for fit, use and care.

2. Do you have all the other required and recommended safety equipment? See Section 2. It's your responsibility to familiarize yourself with the laws of the areas where you ride, and to comply with all applicable laws.

3. Do you know how to correctly secure your front and rear wheels? Check Section 4.A.1 to make sure. Riding with an improperly secured wheel can cause the wheel to wobble or disengage from the bicycle, and cause serious injury or death.

4. If your bike has toeclips and straps or clipless ("step-in") pedals, make sure you know how they work (see Section 4.E). These pedals require special techniques and skills. Follow the pedal manufacturer's instructions for use, adjustment and care.

5. Do you have "toe overlap"? On smaller framed bicycles your toe or toeclip may be able to contact the front wheel when a pedal is all the way forward and the wheel is turned. Read Section 4.E. to check whether you have toeclip overlap.

6. Does your bike have suspension? If so, check Section

4.F. Suspension can change the way a bicycle performs. Follow the suspension manufacturer's instructions for use, adjustment and care.

C. Mechanical Safety Check

Routinely check the condition of your bicycle before every ride.

► **Nuts, bolts screws & other fasteners:** Because manufacturers use a wide variety of fastener sizes and shapes made in a variety of materials, often differing by model and component, the correct tightening force or torque cannot be generalized. To make sure that the many fasteners on your bicycle are correctly tightened, refer to the Fastener Torque Specifications in Appendix D of this manual or to the torque specifications in the instructions provided by the manufacturer of the component in question. Correctly tightening a fastener requires a calibrated torque wrench. A professional bicycle mechanic with a torque wrench should torque the fasteners on your bicycle. If you choose to work on your own bicycle, you must use a torque wrench and the correct tightening torque specifications from the bicycle or component manufacturer or from your dealer. If you need to make an adjustment at home or in the field, we urge you to exercise care, and to have the fasteners you worked on checked by your dealer as soon as possible. *Note that there are some components which require special tools and knowledge. In Sections 3 and 4 we discuss the items which you may be able to adjust yourself. All other adjustments and repairs should be done by a qualified bicycle mechanic.*

 **WARNING: Check all fasteners and quick releases for correct and safe function, even if the bike was left unattended just for a short period of time!**

 **WARNING: Correct tightening force on fasteners – nuts, bolts, screws – on your bicycle is important. Too little force, and the fastener may not hold securely. Too much force, and the fastener can strip threads, stretch, deform or break. Either way, incorrect tightening force can result in component failure, which can cause you to lose control and fall.**

► Make sure nothing is loose. Lift the front wheel off the ground by two or three inches, then let it bounce on the ground. Anything sound, feel or look loose? Do a visual and tactile inspection of the whole bike. Any loose parts or accessories? If so, secure them. If you're not sure, don't start the ride. First ask someone with experience to check.

► **Tires & Wheels:** Make sure tires are correctly inflated (see Section 4.G.1). Check by putting one hand on the saddle, one on the intersection of the handlebars and stem, then bouncing your weight on the bike while looking at tire deflection. Compare what you see with how

it looks when you know the tires are correctly inflated; and adjust if necessary.

- ▶ **Tires in good shape?** Spin each wheel slowly and look for cuts in the tread and sidewall. Replace damaged tires before riding the bike.

- ▶ **Wheels true?** Spin each wheel and check for brake clearance and side-to-side wobble. If a wheel wobbles side to side even slightly, or rubs against or hits the brake pads, take the bike to a qualified bike shop to have the wheel trued.

 **CAUTION: Wheels must be true for rim brakes to work effectively. Wheel truing is a skill which requires special tools and experience. Do not attempt to true a wheel unless you have the knowledge, experience and tools needed to do the job correctly.**

- ▶ **Wheel rims clean and undamaged?** Make sure the rims are clean and undamaged at the tire bead and, if you have rim brakes, along the braking surface. Check to make sure that any rim wear indicator marking is not or still visible at any point on the wheel rim depending on the type of wear indicator used on your bike.

 **WARNING: Bicycle wheel rims are subject to wear. Ask your dealer about wheel rim wear. Some wheel rims have a rim wear indicator which becomes visible or disappears as the rim's braking surface wears. A visible rim wear indicator on the side of the wheel rim is an indication that the wheel rim has reached its maximum usable life. Riding a wheel that is at the end of its usable life can result in wheel failure, which can cause you to lose control and fall.**

- ▶ **Brakes:** Check the brakes for proper operation (see Section 4.C). Squeeze the brake levers. Are the brake quick-releases closed? All control cables seated and securely engaged? If you have rim brakes, do the brake pads contact the wheel rim squarely and make full contact with the rim? Do the brakes begin to engage within an inch of brake lever movement? Can you apply full braking force at the levers without having them touch the handlebar? If not, your brakes need adjustment. Do not ride the bike until the brakes are properly adjusted by a professional bicycle mechanic.

- ▶ **Wheel retention system:** Make sure the front and rear wheels are correctly secured. See Section 4.A

- ▶ **Seat post:** If your seat post has an over-center cam action fastener for easy height adjustment, check that it is properly adjusted and in the locked position. See Section 4.B.

- ▶ **Handlebar and saddle alignment:** Make sure the saddle and handlebar stem are parallel to the bike's center line and clamped tight enough so that you can't twist them out of alignment. See Sections 3.B and 3.C.

- ▶ **Handlebar ends:** Make sure the handlebar grips are secure and in good condition, with no cuts, tears, or worn out areas. If not, have your dealer replace them. Make sure the handlebar ends and extensions are plugged. If not, have your dealer plug them before you ride. If the handlebars have bar end extensions, make sure they are clamped tight enough so you can't twist them.

 **WARNING: Loose or damaged handlebar grips or extensions can cause you to lose control and fall. Unplugged handlebars or extensions can cut you and cause serious injury in an otherwise minor accident.**

VERY IMPORTANT SAFETY NOTE:

Please also read and become thoroughly familiar with the important information on the lifespan of your bicycle and its components in Appendix B on Page 28.

D. First ride

When you buckle on your helmet and go for your first familiarization ride on your new bicycle, be sure to pick a controlled environment, away from cars, other cyclists, obstacles or other hazards. Ride to become familiar with the controls, features and performance of your new bike.

Familiarize yourself with the braking action of the bike (see Section 4.C). Make yourself familiar which levers activates which brake, right/left, front/rear. Test the brakes at slow speed, putting your weight toward the rear and gently applying the brakes, rear brake first. Sudden or excessive application of the front brake could pitch you over the handlebars. Applying brakes too hard can lock up a wheel, which could cause you to lose control and fall. Skidding is an example of what can happen when a wheel locks up.

If your bicycle has toeclips or clipless pedals, practice getting in and out of the pedals. See paragraph B.4 above and Section 4.E.4.

If your bike has suspension, familiarize yourself with how the suspension responds to brake application and rider weight shifts. See paragraph B.6 above and Section 4.F.

Practice shifting the gears (see Section 4.D). Remember to never move the shifter while pedaling backward, nor pedal backwards immediately after having moved the shifter. This could jam the chain and cause serious damage to the bicycle.

Check out the handling and response of the bike; and check the comfort.

If you have any questions, or if you feel anything about the bike is not as it should be, consult your dealer before you ride again.

2. Safety

A. The Basics

WARNING: The area in which you ride may require specific safety devices. It is your responsibility to familiarize yourself with the laws of the area where you ride and to comply with all applicable laws, including properly equipping yourself and your bike as the law requires.

Observe all local bicycle laws and regulations. Observe regulations about bicycle lighting, licensing of bicycles, riding on sidewalks, laws regulating bike path and trail use, helmet laws, child carrier laws, special bicycle traffic laws. It's your responsibility to know and obey the laws.



1. Always wear a cycling helmet which meets the latest certification standards and is appropriate for the type of riding you do. Always follow the helmet manufacturer's instructions for fit, use and care of your helmet. Most serious bicycle injuries involve head injuries which might have been avoided if the rider had worn an appropriate helmet.



WARNING: Failure to wear a helmet when riding may result in serious injury or death.

2. Always do the Mechanical Safety Check (Section 1.C) before you get on a bike.

3. Be thoroughly familiar with the controls of your bicycle: brakes (Section 4.C.); pedals (Section 4.E.); shifting (Section 4.D.)

4. Be careful to keep body parts and other objects away from the sharp teeth of chainrings, the moving chain, the turning pedals and cranks, and the spinning wheels of your bicycle.

5. Always wear:

- Shoes that will stay on your feet and will grip the pedals. Make sure that shoe laces cannot get into moving parts, and never ride barefoot or in sandals.
- Bright, visible clothing that is not so loose that it can be tangled in the bicycle or snagged by objects at the side of the road or trail.
- Protective eyewear, to protect against airborne dirt, dust and bugs — tinted when the sun is bright, clear when it's not.

6. Unless your bicycle was specifically designed for jumping (See Appendix A, Intended Use) don't jump with your bike. Jumping a bike, particularly a BMX or mountain bike, can be fun; but it can put huge and unpredictable stress on the bicycle and its components. Riders who insist on jumping their bikes risk serious damage, to their bicycles as well as to themselves. Before you attempt to

jump, do stunt riding or race with your bike, read and understand Section 2.F.

7. Ride at a speed appropriate for conditions. Higher speed means higher risk.

B. Riding Safety

1. Obey all Rules of the Road and all local traffic laws.

2. You are sharing the road or the path with others — motorists, pedestrians and other cyclists. Respect their rights.

3. Ride defensively. Always assume that others do not see you.

4. Look ahead, and be ready to avoid:

- Vehicles slowing or turning, entering the road or your lane ahead of you, or coming up behind you.
- Parked car doors opening.
- Pedestrians stepping out.
- Children or pets playing near the road.
- Pot holes, sewer grating, railroad tracks, expansion joints, road or sidewalk construction, debris and other obstructions that could cause you to swerve into traffic, catch your wheel or cause you to have an accident.
- The many other hazards and distractions which can occur on a bicycle ride.

5. Ride in designated bike lanes, on designated bike paths or as close to the edge of the road as possible, in the direction of traffic flow or as directed by local governing laws.

6. Stop at stop signs and traffic lights; slow down and look both ways at street intersections. Remember that a bicycle always loses in a collision with a motor vehicle, so be prepared to yield even if you have the right of way.

7. Use approved hand signals for turning and stopping.

8. Never ride with headphones. They mask traffic sounds and emergency vehicle sirens, distract you from concentrating on what's going on around you, and their wires can tangle in the moving parts of the bicycle, causing you to lose control.

9. Never carry a passenger; and, before installing a child carrier or trailer, check with your dealer or the bicycle manufacturer to make sure the bicycle is designed for it. If the bicycle is suitable for a child carrier or trailer, make sure that the carrier or trailer is correctly mounted and the child is secured and wearing an approved helmet.

10. Never carry anything which obstructs your vision or your complete control of the bicycle, or which could become entangled in the moving parts of the bicycle.

11. Never hitch a ride by holding on to another vehicle.

12. Don't do stunts, wheelies, jumps or go racing with your bike despite our advice not to, read Section 2.F, *Downhill, Stunt or Competition Biking*, **now**. Think carefully about your skills before deciding to take the large risks that go with this kind of riding.

13. Don't weave through traffic or make any moves that

may surprise people with whom you are sharing the road.

14. Observe and yield the right of way.

15. Never ride your bicycle while under the influence of alcohol or drugs.

16. If possible, avoid riding in bad weather, when visibility is obscured, at dawn, dusk or in the dark, or when extremely tired. Each of these conditions increases the risk of accident.

C. Off Road Safety

We recommend that children do not ride on rough terrain unless they are accompanied by an adult.

1. The variable conditions and hazards of off-road riding require close attention and specific skills. Start slowly on easier terrain and build up your skills. If your bike has suspension, the increased speed you may develop also increases your risk of losing control and falling. Get to know how to handle your bike safely before trying increased speed or more difficult terrain.

2. Wear safety gear like a helmet and protectors appropriate to the kind of riding you plan to do.

3. Don't ride alone in remote areas. Even when riding with others, make sure that someone knows where you're going and when you expect to be back.

4. Always take along some kind of identification, so that people know who you are in case of an accident; and take along some cash for food, a cool drink or an emergency phone call.

5. Yield right of way to pedestrians and animals. Ride in a way that does not frighten or endanger them, and give them enough room so that their unexpected moves don't endanger you.

6. Be prepared. If something goes wrong while you're riding off-road, help may not be close.

7. Before you attempt to jump, do stunt riding or race with your bike, read and understand Section 2.F.

Off Road respect

Obey the local laws regulating where and how you can ride off-road, and respect private property. You may be sharing the trail with others — hikers, equestrians, other cyclists. Respect their rights. Stay on the designated trail. Don't contribute to erosion by riding in mud or with unnecessary sliding. Don't disturb the ecosystem by cutting your own trail or shortcut through vegetation or streams. It is your responsibility to minimize your impact on the environment. Leave things as you found them; and always take out everything you brought in.

D. Wet Weather Riding

 **WARNING: Wet weather impairs traction, braking and visibility, both for the bicyclist and for other vehicles sharing the road. The risk of an accident is dramatically increased in wet conditions.**

Under wet conditions, the stopping power of your brakes (as well as the brakes of other vehicles sharing the road) is dramatically reduced and your tires don't grip nearly as well. This makes it harder to control speed and easier to lose control. To make sure that you can slow down and stop safely in wet conditions, ride more slowly and apply your brakes earlier and more gradually than you would under normal, dry conditions. See also Section 4.C.

E. Night Riding

Riding a bicycle at night is *much* more dangerous than riding during the day. A bicyclist is very difficult for motorists and pedestrians to see. Therefore, children should never ride at dawn, at dusk or at night. Adults who chose to accept the greatly increased risk of riding at dawn, at dusk or at night need to take extra care both riding and choosing specialized equipment which helps reduce that risk. Consult your dealer about night riding safety equipment.

 **WARNING: Reflectors are not a substitute for required lights. Riding at dawn, at dusk, at night or at other times of poor visibility without an adequate bicycle lighting system and without reflectors is dangerous and may result in serious injury or death.**

Bicycle reflectors are designed to pick up and reflect car lights and street lights in a way that may help you to be seen and recognized as a moving bicyclist.

 **CAUTION: Check reflectors and their mounting brackets regularly to make sure that they are clean, straight, unbroken and securely mounted. Have your dealer replace damaged reflectors and straighten or tighten any that are bent or loose.**

The mounting brackets of front and rear reflectors are often designed as brake straddle cable safety catches which prevent the straddle cable from catching on the tire tread if the cable jumps out of its yoke or breaks.

 **WARNING: Do not remove the front or rear reflectors or reflector brackets from your bicycle. They are an integral part of the bicycle's safety system.**

Removing the reflectors reduces your visibility to others using the roadway. Being struck by other vehicles may result in serious injury or death.

The reflector brackets may protect you from a brake straddle cable catching on the tire in the event of brake cable failure. If a brake straddle cable catches on the tire, it can cause the wheel to stop suddenly, causing you to lose control and fall.

If you choose to ride under conditions of poor visibility, check and be sure you comply with all local laws about night riding, and take the following strongly recommended additional precautions:

- Purchase and install battery or generator powered head and tail lights which meet all regulatory requirements for where you live and provide adequate visibility.
- Wear light colored, reflective clothing and accessories, such as a reflective vest, reflective arm and leg bands, reflective stripes on your helmet, flashing lights attached to your body and/or your bicycle ... any reflective device or light source that moves will help you get the attention of approaching motorists, pedestrians and other traffic.
- Make sure your clothing or anything you may be carrying on the bicycle does not obstruct a reflector or light.
- Make sure that your bicycle is equipped with correctly positioned and securely mounted reflectors.

While riding at dawn, at dusk or at night:

- Ride slowly.
 - Avoid dark areas and areas of heavy or fast-moving traffic.
 - Avoid road hazards.
 - If possible, ride on familiar routes.
- If riding in traffic:
- Be predictable. Ride so that drivers can see you and predict your movements.
 - Be alert. Ride defensively and expect the unexpected.
 - If you plan to ride in traffic often, ask your dealer about traffic safety classes or a good book on bicycle traffic safety.

F. Extreme, stunt or competition riding

Whether you call it *Aggro*, *Hucking*, *Freeride*, *North Shore*, *Downhill*, *Jumping*, *Stunt Riding*, *Racing* or something else: if you engage in this sort of extreme, aggressive riding you **will get hurt**, and you voluntarily assume a greatly increased risk of injury or death.

Not all bicycles are designed for these types of riding, and those that are may not be suitable for all types of aggressive riding. Check with your dealer or the bicycle's manufacturer about the suitability of your bicycle before engaging in extreme riding.

When riding fast down hill, you can reach speeds achieved by motorcycles, and therefore face similar hazards and risks. Have your bicycle and equipment carefully inspected by a qualified mechanic and be sure it is in perfect condition. Consult with expert riders, area site personnel and race officials on conditions and equipment advisable at the site where you plan to ride. Wear appropriate safety gear, including an approved full face helmet, full finger gloves, and body armor. Ultimately, it is your responsibility to have proper equipment and to

be familiar with course conditions.

 **WARNING: Although many catalogs, advertisements and articles about bicycling depict riders engaged in extreme riding, this activity is extremely dangerous, increases your risk of injury or death, and increases the severity of any injury. Remember that the action depicted is being performed by professionals with many years of training and experience. Know your limits and always wear a helmet and other appropriate safety gear. Even with state-of-the-art protective safety gear, you could be seriously injured or killed when jumping, stunt riding, riding downhill at speed or in competition.**

 **WARNING: Bicycles and bicycle parts have limitations with regard to strength and integrity, and this type of riding can exceed those limitations or dramatically reduce the length of their safe use.**

We recommend against this type of riding because of the increased risks; but if you choose to take the risk, at least:

- Take lessons from a competent instructor first
- Start with easy learning exercises and slowly develop your skills before trying more difficult or dangerous riding
- Use only designated areas for stunts, jumping, racing or fast downhill riding
- Wear a full face helmet, safety pads and other safety gear
- Understand and recognize that the stresses imposed on your bike by this kind of activity may break or damage parts of the bicycle and void the warranty
- Take your bicycle to your dealer if anything breaks or bends. Do not ride your bicycle when any part is damaged.

If you ride downhill at speed, do stunt riding or ride in competition, know the limits of your skill and experience. Ultimately, avoiding injury is your responsibility.

G. Changing Components or Adding Accessories

There are many components and accessories available to enhance the comfort, performance and appearance of your bicycle. However, if you change components or add accessories, you do so at your own risk. The bicycle's manufacturer may not have tested that component or accessory for compatibility, reliability or safety on your bicycle. Before installing any component or accessory, including but not limited to a different size tire, a lighting system, a luggage rack, a child seat, a trailer, etc., make sure that it is compatible with your bicycle by checking with your dealer. Be sure to read, understand and follow the instructions that accompany the products you purchase for your bicycle. See also Appendix A, p. 24 and B, p. 28.

 **WARNING:** Failure to confirm compatibility, properly install, operate and maintain any component or accessory can result in serious injury or death.

 **WARNING:** Exposed springs on the saddle of any bicycle fitted with a child seat can cause serious injury to the child. Cover all springs of the saddle and the seatpost to avoid that the child can get hurt.

 **WARNING:** Changing the components on your bike with other than genuine replacement parts may compromise the safety of your bicycle and may void the warranty. Check with your dealer before changing the components on your bike.

3. Fit

NOTE: Correct fit is an essential element of bicycling safety, performance and comfort. Making the adjustments to your bicycle which result in correct fit for your body and riding conditions requires experience, skill and special tools. Always have your dealer make the adjustments on your bicycle; or, if you have the experience, skill and tools, have your dealer check your work before riding.

 **WARNING:** If your bicycle does not fit properly, you may lose control and fall. If your new bike doesn't fit, ask your dealer to exchange it before you ride it.

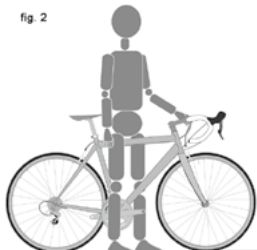

A. Standover height

1. Diamond frame bicycles

Standover height is the basic element of bike fit (see). It is the distance from the ground to the top of the bicycle's frame at that point where your crotch is when straddling the bike. To check for correct standover height, straddle the bike while wearing the kind of shoes in which you'll be riding, and bounce vigorously on your heels. If your crotch touches the frame, the bike is too big for you. Don't even ride the bike around the block. A bike which you ride only on paved surfaces and never take off-road should give you a minimum standover height clearance of two inches (5 cm). A bike that you'll ride on unpaved surfaces should give you a minimum of three inches (7.5 cm) of standover height clearance. And a bike that you'll use off road should give you four inches (10 cm) or more of clearance.

2. Step-through frame bicycles

Standover height does not apply to bicycles with step-through frames. Instead, the limiting dimension is determined by saddle height range. You must be able to adjust your saddle position as described in **B** without exceeding the limits set by the height of the top of the seat tube and the "Minimum Insertion" or "Maximum Extension" mark on the seat post.

B. Saddle position

Correct saddle adjustment is an important factor in getting the most performance and comfort from your bicycle. If the saddle position is not comfortable for you, see your dealer.

The saddle can be adjusted in three directions:

1. Up and down adjustment.

To check for correct saddle height (fig. 3):

- sit on the saddle;
- place one heel on a pedal;
- rotate the crank until the pedal with your heel on it is in the down position and the crank arm is vertical.



If your leg is not completely straight, your saddle height needs to be adjusted. If your hips must rock for the heel to reach the pedal, the saddle is too high. If your leg is bent at the knee with your heel on the pedal, the saddle is too low.

Ask your dealer to set the saddle for your optimal riding position and to show you how to make this adjustment.

If you choose to make your own saddle height adjustment:

- ▶ loosen the seat post clamp
- ▶ raise or lower the seat post in the seat tube
- ▶ make sure the saddle is straight fore and aft
- ▶ re-tighten the seat post clamp to the recommended torque (Appendix D or the manufacturer's instructions).

Once the saddle is at the correct height, make sure that the seat post does not project from the frame beyond its "Minimum Insertion" or "Maximum Extension" mark (fig. 4).

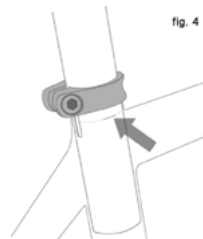

NOTE: Some bicycles have a sight hole in the seat tube, the purpose of which is to make it easy to see whether the seat post is inserted in the seat tube far enough to be safe. If your bicycle has such a sight hole, use it instead of the “Minimum Insertion” or “Maximum Extension” mark to make sure the seat post is inserted in the seat tube far enough to be visible through the sight hole.

If your bike has an interrupted seat tube, as is the case on some suspension bikes, you must also make sure that the seat post is far enough

into the frame so that you can touch it through the bottom of the interrupted seat tube with the tip of your finger without inserting your finger beyond its first knuckle.

In case of an interrupted seat tube you must take care, that the seat post never touches the suspension element or another part of the frame, no matter how much the suspension element is compressed!

Also see NOTE above and fig. 5).



WARNING: If your seat post is not inserted in the seat tube as described in B.1 above, the seat post, binder or even frame may break, which could cause you to lose control and fall.

2. Front and back adjustment. The saddle can be adjusted forward or back to help you get the optimal position on the bike. Ask your dealer to set the saddle for your optimal riding position and to show you how to make this adjustment. If you choose to make your own front and back adjustment, make sure that the clamp mechanism is clamping on the straight part of the saddle rails and is not touching the curved part of the rails, and that you are using the recommended torque on the clamping fastener(s) (Appendix D or the manufacturer's instructions).

3. Saddle angle adjustment. Most people prefer a horizontal saddle; but some riders like the saddle nose angled up or down just a little. Your dealer can adjust saddle angle or teach you how to do it. If you choose to make your own saddle angle adjustment and you have a single bolt saddle clamp on your seat post, it is critical that you loosen the clamp bolt sufficiently to allow any serrations on the mechanism to disengage before changing the saddle's angle, and then that the serrations fully re-engage before you tighten the clamp bolt to the recommended torque (Appendix D or the manufacturer's instructions).

WARNING: When making saddle angle adjustments with a single bolt saddle clamp, always check to make sure that the serrations on the mating surfaces of the clamp are not worn. Worn serrations on the clamp can allow the saddle to move, causing you to lose control and fall.

Always tighten fasteners to the correct torque. Bolts that are too tight can stretch and deform. Bolts that are too loose can move and fatigue. Either mistake can lead to a sudden failure of the bolt, causing you to lose control and fall.

Note: If your bicycle is equipped with a suspension seat post, the suspension mechanism may require periodic service or maintenance. Ask your dealer for recommended service intervals for your suspension seat post.

Small changes in saddle position can have a substantial effect on performance and comfort. To find your best saddle position, make only one adjustment at a time.

WARNING: After any saddle adjustment, be sure that the saddle adjusting mechanism is properly seated and tightened before riding. A loose saddle clamp or seat post clamp can cause damage to the seat post, or can cause you to lose control and fall. A correctly tightened saddle adjusting mechanism will allow no saddle movement in any direction. Periodically check to make sure that the saddle adjusting mechanism is properly tightened.

If, in spite of carefully adjusting the saddle height, tilt and fore-and-aft position, your saddle is still uncomfortable, you may need a different saddle design. Saddles, like people, come in many different shapes, sizes and resilience. Your dealer can help you select a saddle which, when correctly adjusted for your body and riding style, will be comfortable.

WARNING: Some people have claimed that extended riding with a saddle which is incorrectly adjusted or which does not support your pelvic area correctly can cause short-term or long-term injury to nerves and blood vessels, or even impotence. If your saddle causes you pain, numbness or other discomfort, listen to your body and stop riding until you see your dealer about saddle adjustment or a different saddle.

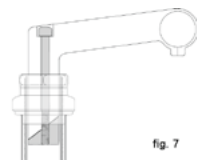
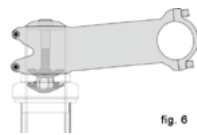



C. Handlebar height and angle

Your bike is equipped either with a “threadless” stem, which clamps on to the outside of the fork shaft, or with a “quill” stem, which clamps inside the steerer tube by way of an expanding binder bolt. If you aren’t absolutely sure which type of stem your bike has, ask your dealer.

If your bike has a “threadless” stem (fig. 6) your dealer may be able to change handlebar height by moving height adjustment spacers from below the stem to above the stem, or vice versa. Otherwise, you’ll have to get a stem of different length or rise. Consult your dealer. Do not attempt to do this yourself, as it requires special knowledge.

If your bike has a “quill” stem on its shaft which designates the stem’s “Minimum Insertion” or “Maximum Extension”. This mark must not be visible above the headset.

 **WARNING: A quill stem’s Minimum Insertion Mark must not be visible above the top of the headset. If the stem is extended beyond the Minimum Insertion Mark the stem may break or damage the fork’s steerer tube, which could cause you to lose control and fall.**

 **WARNING: On some bicycles, changing the stem or stem height can affect the tension of the front brake cable, locking the front brake or creating excess cable slack which can make the brakes and the shifters inoperable. If the brake pads move in towards the wheel rim or out away from the wheel rim when the stem or stem height is changed, the brakes must be correctly adjusted before you ride the bicycle.**

Some bicycles are equipped with an adjustable angle stem. If your bicycle has an adjustable angle stem, ask your dealer to show you how to adjust it. Do not attempt to make the adjustment yourself, as changing stem angle may also require adjustments to the bicycle’s controls.

 **WARNING: Always tighten fasteners to the correct torque. Bolts that are too tight can stretch and deform. Bolts that are too loose can move and fatigue. Either mistake can lead to a sudden failure of the bolt, causing you to lose control and fall.**

Your dealer can also change the angle of the handlebar or bar end extensions.

 **WARNING: An insufficiently tightened stem clamp bolt, handlebar clamp bolt or bar end extension clamping bolt may compromise steering action, which could cause you to lose control and fall. Place the front wheel of the bicycle between your legs and attempt to twist the handlebar/stem assembly. If you can twist the stem in relation to the front wheel, turn the handlebars in**

relation to the stem, or turn the bar end extensions in relation to the handlebar, the bolts are insufficiently tightened.

 **WARNING: Be aware that adding aerodynamic extensions to handlebars will change the steering and braking response of the bicycle.**

D. Control position adjustments

The angle of the brake and shift control levers and their position on the handlebars can be changed. Ask your dealer to make the adjustments for you. If you choose to make your own control lever angle adjustment, be sure to re-tighten the clamp fasteners to the recommended torque (Appendix D or the manufacturer’s instructions).

E. Brake reach

Many bikes have brake levers which can be adjusted for reach. If you have small hands or find it difficult to squeeze the brake levers, your dealer can either adjust the reach or fit shorter reach brake levers.

 **WARNING: The shorter the brake lever reach, the more critical it is to have correctly adjusted brakes, so that full braking power can be applied within available brake lever travel. Make shure, that the brake levers never touches the handlebar or the grips, no matter how hard you pull them. Brake lever travel insufficient to apply full braking power can result in loss of control, which may result in serious injury or death.**

4. Tech

It’s important to your safety, performance and enjoyment to understand how things work on your bicycle. We urge you to ask your dealer how to do the things described in this section before you attempt them yourself, and that you have your dealer check your work before you ride the bike. If you have even the slightest doubt as to whether you understand something in this section of the Manual, talk to your dealer. *See also Appendix A, B, C and D.*

A. Wheels

Bicycle wheels are designed to be removable for easier transportation and for repair of a tire puncture. In most cases, the wheel axles are inserted into slots, called “dropouts” in the fork and frame, but some mountain and road bikes use what is called a “through axle” wheel mounting system.

If you have a mountain or road bike equipped with through axle front or rear wheels, make sure that your dealer has given you the manufacturer's instructions, and follow those when installing or removing a through axle wheel. If you don't know what a through axle is, ask your dealer.

If you do not have a bicycle with a through-axle wheel mounting system, it will have wheels secured in one of three ways:

- A hollow axle with a shaft ("skewer") running through it which has an adjustable tension nut on one end and an over-center cam on the other (cam action system, fig.8 a & b)
- A hollow axle with a shaft ("skewer") running through it which has a nut on one end and a fitting for a hex key, lock lever or other tightening device on the other (through bolt, fig. 9)
- Hex nuts or hex key bolts which are threaded on to or into the hub axle (bolt-on wheel, fig. 10)

Your bicycle may be equipped with a different securing method for the front wheel than for the rear wheel. Discuss the wheel securing method for your bicycle with your dealer.

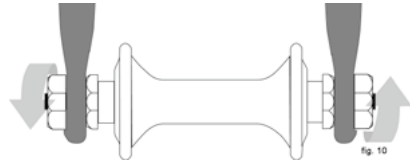

It is very important that you understand the type of wheel securing method on your bicycle, that you know how to secure the wheels correctly, and that you know how to apply the correct clamping force that safely secures the wheel. Ask your dealer to instruct you in correct wheel removal and installation, and ask him to give you any available manufacturer's instructions.

⚠ WARNING: Riding with an improperly secured wheel can allow the wheel to wobble or fall off the bicycle, which can cause serious injury or death. Therefore, it is essential that you:

1. Ask your dealer to help you make sure you know how to install and remove your wheels safely.
2. Understand and apply the correct technique for clamping your wheel in place.
3. Each time, before you ride the bike, check that the wheel is securely clamped.

The clamping action of a correctly secured wheel must emboss the surfaces of the dropouts.

1. Front Wheel Secondary Retention Devices

Most bicycles have front forks which utilize a secondary wheel retention device to reduce the risk of the wheel disengaging from the fork if the wheel is incorrectly secured. Secondary retention devices are not a substitute for correctly securing your front wheel.

Secondary retention devices fall into two basic categories:

- a. The clip-on type is a part which the manufacturer adds to the front wheel hub or front fork.
- b. The integral type is molded, cast or machined into the outer faces of the front fork dropouts.

Ask your dealer to explain the particular secondary retention device on your bike.

⚠ WARNING: Do not remove or disable the secondary retention device. As its name implies, it serves as a back-up for a critical adjustment. If the wheel is not secured correctly, the secondary retention device can reduce the risk of the wheel disengaging from the fork. Removing or disabling the secondary retention device may also void the warranty.

Secondary retention devices are not a substitute for correctly securing your wheel. Failure to properly secure the wheel can cause the wheel to wobble or disengage, which could cause you to lose control and fall, resulting in serious injury or death.

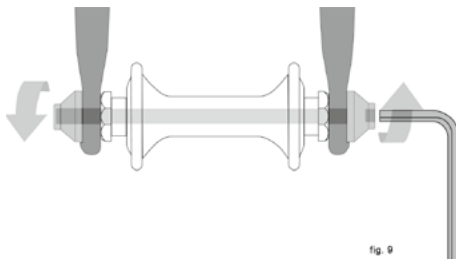
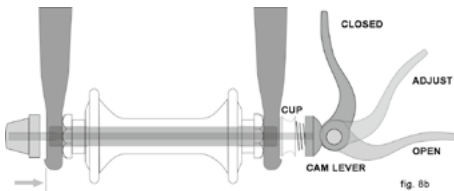
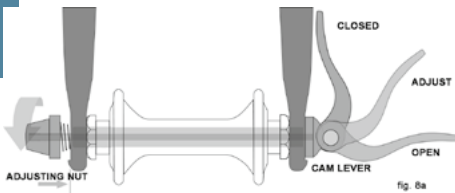

2. Wheels with cam action systems

There are currently two types of over-center cam wheel retention mechanisms: the traditional over-center cam (fig. 8a) and the cam-and-cup system (fig. 8b). Both use an over-center cam action to clamp the bike's wheel in place. Your bicycle may have a cam-and-cup front wheel retention system and a traditional rear wheel cam action system.

a. Adjusting the traditional cam action mechanism (fig. 8a)

The wheel hub is clamped in place by the force of the over-center cam pushing against one dropout and pulling the tension adjusting nut, by way of the skewer, against the other dropout. The amount of clamping force is controlled by the tension adjusting nut. Turning the tension adjusting nut clockwise while keeping the opened cam lever from rotating increases clamping force; turning it counterclockwise while keeping the opened cam lever from rotating reduces clamping force. Less than half a turn of the tension adjusting nut can make the difference between safe clamping force and unsafe clamping force.

 **WARNING:** The full force of the cam action is needed to clamp the wheel securely. Holding the nut with one hand and turning the lever like a wing nut with the other hand until everything is as tight as you can get it will not clamp a cam action wheel safely in the dropouts. See also the first WARNING in this Section, p. 18.

b. Adjusting the cam-and-cup mechanism (fig. 8b)

The cam-and-cup system on your front wheel will have been correctly adjusted for your bicycle by your dealer. Ask your dealer to check the adjustment every six months. **Do not use a cam-and-cup front wheel on any bicycle other than the one for which your dealer adjusted it.**

3. Removing and Installing wheels

 **WARNING:** If your bike is equipped with a hub brake such as a rear coaster brake, front or rear drum, band or roller brake; or if it has an internal gear rear hub, do not attempt to remove the wheel. The removal and re-installation of most hub brakes and internal gear hubs requires special knowledge. Incorrect removal or assembly can result in brake or gear failure, which can cause you to lose control and fall.

CAUTION: If your bike has a disc brake, exercise care in touching the rotor or caliper. Disc rotors have sharp edges, and both rotor and caliper can get very hot during use.

a. Removing a disk brake or rim brake Front Wheel

(1) If your bike has rim brakes, disengage the brake's quick-release mechanism to increase the clearance between the tire and the brake pads (See Section 4.C fig. 11 through 15).

(2) If your bike has cam action front wheel retention, move the cam lever from the locked or CLOSED position to the OPEN position (figs. 8a & b). If your bike has through bolt or bolt-on front wheel retention, loosen the fastener(s) a few turns counter-clockwise using an appropriate wrench, lock key or the integral lever.

(3) If your front fork has a clip-on type secondary retention device, disengage it. If your front fork has an integral secondary retention device, and a traditional cam action system (fig. 8a) loosen the tension adjusting nut enough to allow removing the wheel from the dropouts. If your front wheel uses a cam-and-cup system, (fig. 8b) squeeze the cup and cam lever together while removing the wheel. No rotation of any part is necessary with the cam-and-cup system.

You may need to tap the top of the wheel with the palm of your hand to release the wheel from the front fork.

b. Installing a disk brake or rim brake Front Wheel

 **CAUTION:** If your bike is equipped with a front disk brake, be careful not to damage the disk, caliper or brake pads when re-inserting the disk into the caliper. Never activate a disk brake's control lever unless the disk is correctly inserted in the caliper and the bike is in an upright position. See also Section 4.C.

(1) If your bike has cam action front wheel retention, move the cam lever so that it curves away from the wheel (fig. 8b). This is the OPEN position. If your bike has through bolt or bolt-on front wheel retention, go to the next step. Make sure that the brake disc is positioned on the correct side so it can fit in the caliper.

(2) With the steering fork facing forward, insert the wheel between the fork blades so that the axle seats firmly at the top of the fork dropouts. The cam lever, if there is one, should be on rider's left side of the bicycle (fig. 8a & b). If your bike has a clip-on type secondary retention device, engage it.

(3) If you have a traditional cam action mechanism: holding the cam lever in the ADJUST position with your right hand, tighten the tension adjusting nut with your left hand until it is finger tight against the fork dropout (fig. 8a). If you have a cam-and-cup system: the nut and cup (fig. 8b) will have snapped into the recessed area of the fork dropouts and no adjustment should be required.

(4) While pushing the wheel firmly to the top of the slots in the fork dropouts, and at the same time centering the wheel rim in the fork:

(a) With a cam action system, move the cam lever upwards and swing it into the CLOSED position (fig. 8a & b). The lever should now be parallel to the fork blade and curved toward the wheel. It should point backwards to avoid being opened by contact while riding. To apply enough clamping force, you should have to wrap your fingers around the fork blade for leverage, and the lever

should leave a clear imprint in the palm of your hand.

(b) With a through-bolt or bolt-on system, tighten the fasteners to the torque specifications in Appendix D or the hub manufacturer's instructions.

NOTE: If, on a traditional cam action system, the lever cannot be pushed all the way to a position parallel to the fork blade, return the lever to the OPEN position. Then turn the tension adjusting nut counterclockwise one-quarter turn and try tightening the lever again.

D (6) With a through-bolt or bolt-on system, tighten the fasteners to the torque specifications in Appendix D or the hub manufacturer's instructions.

 **WARNING: Securely clamping the wheel with a cam action retention device takes considerable force. If you can fully close the cam lever without wrapping your fingers around the fork blade for leverage, the lever does not leave a clear imprint in the palm of your hand, and the serrations on the wheel fastener do not emboss the surfaces of the dropouts, the tension is insufficient. Open the lever; turn the tension adjusting nut clockwise a quarter turn; then try again. See also the first WARNING in this Section, p. 18.**

(6) If you disengaged the brake quick-release mechanism in 3. a. (1) above, re-engage it to restore correct brake pad-to-rim clearance.

(7) Spin the wheel to make sure that it is centered in the frame and clears the brake pads; then squeeze the brake lever and make sure that the brakes are operating correctly.

c. Removing a disk brake or rim brake Rear Wheel

(1) If you have a multi-speed bike with a derailleur gear system: shift the rear derailleur to high gear (the smallest, outermost rear sprocket).

If you have an internal gear rear hub, consult your dealer or the hub manufacturer's instructions before attempting to remove the rear wheel.

If you have a single-speed bike with rim or disk brake, go to step (4) below.

(2) If your bike has rim brakes, disengage the brake's quick-release mechanism to increase the clearance between the wheel rim and the brake pads (see Section 4.C, figs. 11 through 15).

(3) On a derailleur gear system, pull the derailleur body back with your right hand.

(4) With a cam action mechanism, move the quick-release lever to the OPEN position (fig. 8b). With a through bolt or bolt on mechanism, loosen the fastener(s) with an appropriate wrench, lock lever or integral lever; then push the wheel forward far enough to be able to remove the chain from the rear sprocket.

(5) Lift the rear wheel off the ground a few inches and

remove it from the rear dropouts.

d. Installing a disk brake or rim brake Rear Wheel

 **CAUTION: If your bike is equipped with a rear disk brake, be careful not to damage the disk, caliper or brake pads when re-inserting the disk into the caliper. Never activate a disk brake's control lever unless the disk is correctly inserted in the caliper and the bike is in an upright position.**

(1) With a cam action system, move the cam lever to the OPEN position (see fig. 8 a & b). The lever should be on the side of the wheel opposite the derailleur and freewheel sprockets.

(2) On a derailleur bike, make sure that the rear derailleur is still in its outermost, high gear, position; then pull the derailleur body back with your right hand. Put the upper part of the chain on top of the smallest freewheel sprocket.

(3) On single-speed or an internal gear hub, remove the chain from the front sprocket, so that you have plenty of slack in the chain. Put the chain on the rear wheel sprocket.

(4) Then, insert the wheel into the frame dropouts and pull it all the way in to the dropouts. Make sure that the brake disc fits correctly in the caliper.

(5) On a single speed or an internal gear hub, replace the chain on the chainring; pull the wheel back in the dropouts so that it is straight in the frame and the chain has about 1/4 inches of up-and-down play.

(6) With a cam action system, move the cam lever upwards and swing it into the CLOSED position (fig. 8 a & b). The lever should now be parallel to the seat stay or pointing backwards and curved toward the wheel. To apply enough clamping force, you should have to wrap your fingers around the fork blade for leverage, and the lever should leave a clear imprint in the palm of your hand.

(7) With a through-bolt or bolt-on system, tighten the fasteners to the torque specifications in Appendix D or the hub manufacturer's instructions.

NOTE: If, on a traditional cam action system, the lever cannot be pushed all the way to a position parallel to the seat stay, return the lever to the OPEN position. Then turn the tension adjusting nut counterclockwise one-quarter turn and try tightening the lever again.

 **WARNING: Securely clamping the wheel with a cam action retention device takes considerable force. If you can fully close the cam lever without wrapping your fingers around the seat stay or chain stay for leverage, the lever does not leave a clear imprint in the palm of your hand, and the serrations on the wheel**

fastener do not emboss the surfaces of the dropouts, the tension is insufficient. Open the lever; turn the tension adjusting nut clockwise a quarter turn; then try again.

(8) If you disengaged the brake quick-release mechanism in 3. c. (2) above, re-engage it to restore correct brake pad-to-rim clearance.

(9) Spin the wheel to make sure that it is centered in the frame and clears the brake pads; then squeeze the brake lever and make sure that the brakes are operating correctly.

B. Seat post cam action clamp

Some bikes are equipped with a cam action seat post binder. The seat post cam action binder works exactly like the traditional wheel cam action fastener (Section 4.A.2) While a cam action binder looks like a long bolt with a lever on one end and a nut on the other, the binder uses an over-center cam action to firmly clamp the seat post (see fig. 8a).

 **WARNING:** Riding with an improperly tightened seat post can allow the saddle to turn or move and cause you to lose control and fall. Therefore:

1. Ask your dealer to help you make sure you know how to correctly clamp your seat post.
2. Understand and apply the correct technique for clamping your seat post.
3. Before you ride the bike, first check that the seat post is securely clamped.

Adjusting the seat post cam action mechanism

The action of the cam squeezes the seat collar around the seat post to hold the seat post securely in place. The amount of clamping force is controlled by the tension adjusting nut. Turning the tension adjusting nut clockwise while keeping the cam lever from rotating increases clamping force; turning it counterclockwise while keeping the cam lever from rotating reduces clamping force. Less than half a turn of the tension adjusting nut can make the difference between safe and unsafe clamping force.

 **WARNING:** Especially if components (seat post, frame) made of composites like carbon fibre are in use, never overtighten the seat post clamp!

Composites and carbon fibre require a different clamping force. Read the manufacturers manual for correct use.

 **WARNING:** The full force of the cam action is needed to clamp the seat post securely. Holding the nut with one hand and turning the lever like a wing nut with the other hand until everything is as tight as you can get it will not clamp the seat post safely.

 **WARNING:** If you can fully close the cam lever without wrapping your fingers around the seat post or a frame tube for leverage, and the lever does not leave a clear imprint in the palm of your hand, the tension is insufficient. Open the lever; turn the tension adjusting nut clockwise a quarter turn; then try again.

C. Brakes

There are three general types of bicycle brakes: rim brakes, which operate by squeezing the wheel rim between two brake pads; disc brakes, which operate by squeezing a hub-mounted disc between two brake pads; and internal hub brakes. All three can be operated by way of a handlebar mounted lever. On some models of bicycle, the internal hub brake is operated by pedaling backwards. This is called a Coaster Brake and is described in Appendix C.

 **WARNING:**

1. Riding with improperly adjusted brakes, worn brake pads, or wheels on which the rim wear mark is visible or invisible because of rim wear is dangerous and can result in serious injury or death.

2. Applying brakes too hard or too suddenly can lock up a wheel, which could cause you to lose control and fall. Sudden or excessive application of the front brake may pitch the rider over the handlebars, which may result in serious injury or death.

3. Some bicycle brakes, such as disc brakes (fig. 11) and linear-pull brakes (fig. 12), are extremely powerful. Take extra care in becoming familiar with these brakes and exercise particular care when using them.

4. Some bicycle brakes are equipped with a brake force modulator, a small, cylindrical device through which the brake control cable runs and which is designed to provide a more progressive application of braking force. A modulator makes the initial brake lever force more gentle, progressively increasing force until full force is achieved. If your bike is equipped with a brake force modulator, take extra care in becoming familiar with its performance characteristics. Some brake force modulators are adjustable. If you don't like the feel of your brakes, ask your dealer about adjusting the brake force modulation.

5. Disc brakes can get extremely hot with extended use. Be careful not to touch a disc brake until it has had plenty of time to cool.

6. See the brake manufacturer's instructions for operation and care of your brakes, and for when brake pads must be replaced. If you do not have the manufacturer's instructions, see your dealer or contact the brake manufacturer.

7. If replacing worn or damaged parts, use only manufacturer-approved genuine replacement parts.

1. Brake controls and features

It's very important to your safety that you learn and remember which brake lever controls which brake on your bike. Traditionally, in the U.S. the right brake lever controls the rear brake and the left brake lever controls the front brake; but, to check how your bike's brakes are set up, squeeze one brake lever and look to see which brake, front or rear, engages. Now do the same with the other brake lever.

Make sure that your hands can reach and squeeze the brake levers comfortably. If your hands are too small to operate the levers comfortably, consult your dealer before riding the bike. The lever reach may be adjustable; or you may need a different brake lever design.

Most rim brakes have some form mechanism to allow the brake pads a wheel is removed or reinstalled. When the brake quick release is in the open position, the brakes are inoperative. Ask your dealer to make sure that you understand the way the brake quick release works on your bike (see figs. 12, 13, 14 & 15) and check each time to make sure both brakes work correctly before you get on the bike.

2. How brakes work

The braking action of a bicycle is a function of the friction between the braking surfaces. To make sure that you have maximum friction available, keep your wheel rims and brake pads or the disk rotor and caliper clean and free of dirt, lubricants, waxes or polishes.

Brakes are designed to control your speed, not just to stop the bike. Maximum braking force for each wheel occurs at the point just before the wheel "locks up" (stops rotating) and starts to skid. Once the tire skids, you actually lose most of your stopping force and all directional control. You need to practice slowing and stopping smoothly without locking up a wheel. The technique is called progressive brake modulation. Instead of jerking the brake lever to the position where you think you'll generate appropriate braking force, squeeze the

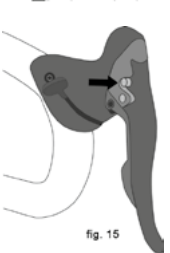
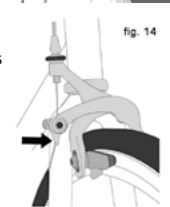
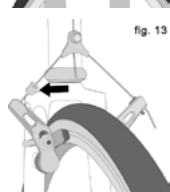
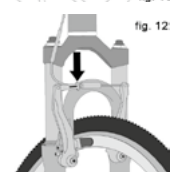

lever, progressively increasing the braking force. If you feel the wheel begin to lock up, release pressure just a little to keep the wheel rotating just short of lockup. It's important to develop a feel for the amount of brake lever pressure required for each wheel at different speeds and on different surfaces. To better understand this, experiment a little by walking your bike and applying different amounts of pressure to each brake lever, until the wheel locks.

When you apply one or both brakes, the bike begins to slow, but your body wants to continue at the speed at which it was going. This causes a transfer of weight to the front wheel (or, under heavy braking, around the front wheel hub, which could send you flying over the handlebars).

A wheel with more weight on it will accept greater brake pressure before lockup; a wheel with less weight will lock up with less brake pressure. So, as you apply brakes and your weight is transferred forward, you need to shift your body toward the rear of the bike, to transfer weight back on to the rear wheel; and at the same time, you need to both decrease rear braking and increase front braking force. This is even more important on descents, because descents shift weight forward.

Two keys to effective speed control and safe stopping are controlling wheel lockup and weight transfer. This weight transfer is even more pronounced if your bike has a front suspension fork. Front suspension "dips" under braking, increasing the weight transfer (see also Section 4.F). Practice braking and weight transfer techniques where there is no traffic or other hazards and distractions.

Everything changes when you ride on loose surfaces or in wet weather. It will take longer to stop on loose surfaces or in wet weather. Tire adhesion is reduced, so the wheels have less cornering and braking traction and can lock up with less brake force. Moisture or dirt on the brake pads reduces their ability to grip. The way to maintain control on loose or wet surfaces is to go more slowly.

D. Shifting gears

Your multi-speed bicycle will have a derailleur drivetrain (see 1. below), an internal gear hub drivetrain (see 2. below) or, in some special cases, a combination of the two.

1. How a derailleur drivetrain works

If your bicycle has a derailleur drivetrain, the gear-changing mechanism will have:

- a rear cassette or freewheel sprocket cluster
- a rear derailleur
- usually a front derailleur
- one or two shifters
- one, two or three front sprockets called chainrings
- a drive chain

a. Shifting Gears

There are several different types and styles of shifting controls: levers, twist grips, triggers, combination shift/brake controls and push-buttons. Ask your dealer to explain the type of shifting controls that are on your bike, and to show you how they work.

The vocabulary of shifting can be pretty confusing. A downshift is a shift to a “lower” or “slower” gear, one which is easier to pedal. An upshift is a shift to a “higher” or “faster”, harder to pedal gear. What’s confusing is that what’s happening at the front derailleur is the opposite of what’s happening at the rear derailleur (for details, read the instructions on Shifting the Rear Derailleur and Shifting the Front Derailleur below). For example, you can select a gear which will make pedaling easier on a hill (make a downshift) in one of two ways: shift the chain down the gear “steps” to a smaller gear at the front, or up the gear “steps” to a larger gear at the rear. So, at the rear gear cluster, what is called a downshift looks like an upshift. The way to keep things straight is to remember that shifting the chain in towards the centerline of the bike is for accelerating and climbing and is called a downshift. Moving the chain out or away from the centerline of the bike is for speed and is called an upshift.

Whether upshifting or downshifting, the bicycle derailleur system design requires that the drive chain is moving forward and be under at least some tension. A derailleur will shift only if you are pedaling forward.

 **CAUTION:** Never move the shifter while pedaling backward, nor pedal backwards immediately after having moved the shifter. This could jam the chain and cause serious damage to the bicycle.

b. Shifting the Rear Derailleur

The rear derailleur is controlled by the right shifter.

The function of the rear derailleur is to move the drive chain from one gear sprocket to another. The smaller sprockets on the gear cluster produce higher gear ratios. Pedaling in the higher gears requires greater pedaling effort, but takes you a greater distance with each revolution of the pedal cranks. The larger sprockets produce lower gear ratios. Using them requires less pedaling effort, but takes you a shorter distance with each pedal crank revolution. Moving the chain from a smaller sprocket of the gear cluster to a larger sprocket results in a downshift. Moving the chain from a larger sprocket to a smaller sprocket results in an upshift. In order for the derailleur to move the chain from one sprocket to another, the rider must be pedaling forward.

c. Shifting the Front Derailleur:

The front derailleur, which is controlled by the left shifter, shifts the chain between the larger and smaller chainrings. Shifting the chain onto a smaller chainring makes pedaling easier (a downshift). Shifting to a larger chainring makes pedaling harder (an upshift).

d. Which gear should I be in?

The combination of largest rear and smallest front gears (fig. 16) is for the steepest hills. The smallest rear and largest front combination is for the greatest speed. It is not necessary to shift gears in sequence. Instead, find the “starting gear” which is right for your level of ability – a gear which is hard enough for quick acceleration but easy enough to let you start from a stop without wobbling – and

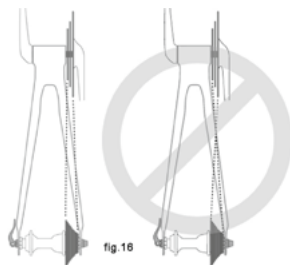

experiment with upshifting and downshifting to get a feel for the different gear combinations. At first, practice shifting where there are no obstacles, hazards or other traffic, until you’ve built up your confidence. Learn not to use either the “smallest to smallest” or “largest to largest” gear combinations because they may cause unacceptable stress on the drive train. Learn to anticipate the need to shift, and shift to a lower gear *before* the hill gets too steep. If you have difficulties with shifting, the problem could be mechanical adjustment. See your dealer for help.

 **WARNING:** Never shift a derailleur onto the largest or the smallest sprocket if the derailleur is not shifting smoothly. The derailleur may be out of adjustment and the chain could jam, causing you to lose control and fall.

e. What if it won’t shift gears?

If moving the shift control one click repeatedly fails to result in a smooth shift to the next gear chances are that the mechanism is out of adjustment. Take the bike to your dealer to have it adjusted.

2. How an internal gear hub drivetrain works

If your bicycle has an internal gear hub drivetrain, the gear changing mechanism will consist of:

- a 3, 5, 7, 8, 11, 12, 14, 18 speed or possibly an infinitely variable internal gear hub
- one, or sometimes two shifters
- one or two control cables
- one front sprocket called a chainring
- a drive chain

a. Shifting internal gear hub gears

Shifting with an internal gear hub drivetrain is simply a

matter of moving the shifter to the indicated position for the desired gear ratio. After you have moved the shifter to the gear position of your choice, ease the pressure on the pedals for an instant to allow the hub to complete the shift.

b. Which gear should I be in?

The numerically lowest gear (1) is for the steepest hills. The numerically largest gear is for the greatest speed.

Shifting from an easier, “slower” gear (like 1) to a harder, “faster” gear (like 2 or 3) is called an upshift. Shifting from a harder, “faster” gear to an easier, “slower” gear is called a downshift. It is not necessary to shift gears in sequence. Instead, find the “starting gear” for the conditions — a gear which is hard enough for quick acceleration but easy enough to let you start from a stop without wobbling — and experiment with upshifting and downshifting to get a feel for the different gears. At first, practice shifting where there are no obstacles, hazards or other traffic, until you’ve built up your confidence. Learn to anticipate the need to shift, and shift to a lower gear *before* the hill gets too steep. If you have difficulties with shifting, the problem could be mechanical adjustment. See your dealer for help.

c. What if it won’t shift gears?

If moving the shift control one click repeatedly fails to result in a smooth shift to the next gear chances are that the mechanism is out of adjustment. Take the bike to your dealer to have it adjusted.

E. Pedals

1. Toe Overlap is when your toe can touch the front wheel when you turn the handlebars to steer while a pedal is in the forwardmost position. This is common on small-framed bicycles, and is avoided by keeping the inside pedal up and the outside pedal down when making sharp turns. On any bicycle, this technique will also prevent the inside pedal from striking the ground in a turn.

NOTE: Changing tire size or pedal crank arm length affects toe overlap.

 **WARNING: Toe Overlap could cause you to lose control and fall. Ask your dealer to help you determine if the combination of frame size, crank arm length, pedal design and shoes you will use results in pedal overlap. Whether you have overlap or not, you must keep the inside pedal up and the outside pedal down when making sharp turns.**

2. Some bicycles come equipped with pedals that have sharp and potentially dangerous surfaces. These surfaces are designed to add safety by increasing grip between the

rider’s shoe and the pedal. If your bicycle has this type of high-performance pedal, you must take extra care to avoid serious injury from the pedals’ sharp surfaces. Based on your riding style or skill level, you may prefer a less aggressive pedal design, or chose to ride with shin pads. Your dealer can show you a number of options and make suitable recommendations.

3. Toeclips and straps are a means to keep feet correctly positioned and engaged with the pedals. The toeclip positions the ball of the foot over the pedal spindle, which gives maximum pedaling power. The toe strap, when tightened, keeps the foot engaged throughout the rotation cycle of the pedal. While toeclips and straps give some benefit with any kind of shoe, they work most effectively with cycling shoes designed for use with toeclips. Your dealer can explain how toeclips and straps work. Shoes with deep treaded soles or welts which might make it more difficult for you to insert or remove your foot should not be used with toeclips and straps.

 **WARNING: Getting into and out of pedals with toeclips and straps requires skill which can only be acquired with practice. Until it becomes a reflex action, the technique requires concentration which can distract your attention and cause you to lose control and fall. Practice the use of toeclips and straps where there are no obstacles, hazards or traffic. Keep the straps loose, and don’t tighten them until your technique and confidence in getting in and out of the pedals warrants it. Never ride in traffic with your toe straps tight.**

4. Clipless pedals (sometimes called “step-in pedals”) are another means to keep feet securely in the correct position for maximum pedaling efficiency. They have a plate, called a “cleat,” on the sole of the shoe, which clicks into a mating spring-loaded fixture on the pedal. They only engage or disengage with a very specific motion which must be practiced until it becomes instinctive. Clipless pedals require shoes and cleats which are compatible with the make and model pedal being used.

Many clipless pedals are designed to allow the rider to adjust the amount of force needed to engage or disengage the foot. Follow the pedal manufacturer’s instructions, or ask your dealer to show you how to make this adjustment. Use the easiest setting until engaging and disengaging becomes a reflex action, but always make sure that there is sufficient tension to prevent unintended release of your foot from the pedal.

 **WARNING: Clipless pedals are intended for use with shoes specifically made to fit them and are designed to firmly keep the foot engaged with the pedal. Do not use shoes which do not engage the pedals correctly.**

Practice is required to learn to engage and disengage the foot safely. Until engaging and disengaging the foot becomes a reflex action, the technique requires concentration which can distract your attention and cause you to lose control and fall. Practice engaging and disengaging clipless pedals in a place where there are no obstacles, hazards or traffic; and be sure to follow the pedal manufacturer's setup and service instructions. If you do not have the manufacturer's instructions, see your dealer or contact the manufacturer.

F. Bicycle Suspension

Many bicycles are equipped with suspension systems. There are many different types of suspension systems — too many to deal with individually in this manual. If your bicycle has a suspension system of any kind, be sure to read, understand and follow the suspension manufacturer's setup and service instructions. If you do not have the manufacturer's instructions, see your dealer or contact the manufacturer.

WARNING: Failure to maintain, check and properly adjust the suspension system may result in suspension malfunction, which may cause you to lose control and fall.

If your bike has suspension, the increased speed you may develop also increases your risk of injury. For example, when braking, the front of a suspended bike dips. You could lose control and fall if you do not have experience with this system. Learn to handle your suspension system safely. See also Section 4.C.

WARNING: Changing suspension adjustment can change the handling and braking characteristics of your bicycle. Never change suspension adjustment unless you are thoroughly familiar with the suspension system manufacturer's instructions and recommendations, and always check for changes in the handling and braking characteristics of the bicycle after a suspension adjustment by taking a careful test ride in a hazard-free area.

Suspension can increase control and comfort by allowing the wheels to better follow the terrain. This enhanced capability may allow you to ride faster; but you must not confuse the enhanced capabilities of the bicycle with your own capabilities as a rider. Increasing your skill will take time and practice. Proceed carefully until you have learned to handle the full capabilities of your bike.

WARNING: Not all bicycles can be safely retrofitted with some types of suspension systems. Before retrofitting a bicycle with any suspension, check with the bicycle's manufacturer to make sure that what you want to do is compatible with the bicycle's design. Failing to do so can result in catastrophic frame failure.

G. Tires and Tubes

WARNING: Some bicycles intended for competition are fitted with tires which are glued on to specially made rims. These are called "sew-up" or "tubular" tires. Properly mounting these tires requires specialized knowledge and skills. Ask your dealer to teach you how to mount tubulars before you attempt it on your own. An incorrectly installed tubular tire can come off the rim, causing you to lose control and fall.

1. Tires

Bicycle tires are available in many designs and specifications, ranging from general-purpose designs to tires designed to perform best under very specific weather or terrain conditions. If, once you've gained experience with your new bike, you feel that a different tire might better suit your riding needs, your dealer can help you select the most appropriate design.

The size, pressure rating, and on some high-performance tires the specific recommended use, are marked on the sidewall of the tire (see fig. 17). The part of this information which is most important to you is Tire Pressure. But some wheel rim manufacturers also specify maximum tire pressure with a label on the rim.

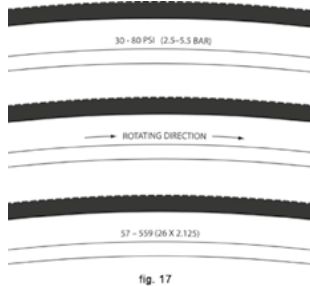

fig. 17

WARNING: Never inflate a tire beyond the maximum pressure marked on the tire's sidewall or the wheel rim. If the maximum pressure rating for the wheel rim is lower than the maximum pressure shown on the tire, always use the lower rating. Exceeding the recommended maximum pressure may blow the tire off the rim or damage the wheel rim, which could cause damage to the bike and injury to the rider and bystanders.

The best and safest way to inflate a bicycle tire to the correct pressure is with a bicycle pump which has a built-in pressure gauge.

⚠ WARNING: There is a safety risk in using gas station air hoses or other air compressors. They are not made for bicycle tires. They move a large volume of air very rapidly, and will raise the pressure in your tire very rapidly, which could cause the tube to explode.

Tire pressure is given either as maximum pressure or as a pressure range. How a tire performs under different terrain or weather conditions depends largely on tire pressure. Inflating the tire to near its maximum recommended pressure gives the lowest rolling resistance; but also produces the harshest ride. High pressures work best on smooth, dry pavement.

Very low pressures, at the bottom of the recommended pressure range, give the best performance on smooth, slick terrain such as hard-packed clay, and on deep, loose surfaces such as deep, dry sand.

Tire pressure that is too low for your weight and the riding conditions can cause a puncture of the tube by allowing the tire to deform sufficiently to pinch the inner tube between the rim and the riding surface. It can also lead to a tire that slips of the rim in sharp turns or during aggressive moves. Both can lead to falls and injuries.

⚠ CAUTION: Pencil type automotive tire gauges can be inaccurate and should not be relied upon for consistent, accurate pressure readings. Instead, use a high quality dial gauge.

Ask your dealer to recommend the best tire pressure for the kind of riding you will most often do, and have the dealer inflate your tires to that pressure. Then, check inflation as described in Section 1.C so you'll know how correctly inflated tires should look and feel when you don't have access to a gauge. Some tires may need to be brought up to pressure every week or two, so it is important to check your tire pressures before every ride.

Some special high-performance tires have unidirectional treads: their tread pattern is designed to work better in one direction than in the other. The sidewall marking of a unidirectional tire will have an arrow showing the correct rotation direction. If your bike has unidirectional tires, be sure that they are mounted to rotate in the correct direction.

2. Tire Valves

There are primarily two kinds of bicycle tire valves: The Schraeder Valve and the Presta Valve. The bicycle pump you use must have the fitting appropriate to the valve stems on your bicycle.

The Schraeder valve (fig. 18a) is like the valve



fig 18a

on a car tire. To inflate a Schraeder valve tire, remove the valve cap and clamp the pump fitting onto the end of the valve stem. To let air out of a Schraeder valve, depress the pin in the end of the valve stem with the end of a key or other appropriate object.

The Presta valve (fig. 18b) has a narrower diameter and is only found on bicycle tires. To inflate a Presta valve tire using a Presta headed bicycle pump, remove the valve cap; unscrew (counterclockwise) the valve stem lock nut; and push down on the valve stem to free it up. Then push the pump head on to the valve head, and inflate. To inflate a Presta valve with a Schraeder pump fitting, you'll need a Presta adapter (available at your bike shop) which screws on to the valve stem once you've freed up the valve. The adapter fits into the Schraeder pump fitting. Close the valve after inflation. To let air out of a Presta valve, open up the valve stem lock nut and depress the valve stem.



fig 18b

⚠ WARNING: We highly recommend that you carry a spare inner tube when you ride your bike, unless the bike is fitted with tubeless tires. Patching a tube is an emergency repair. If you do not apply the patch correctly or apply several patches, the tube can fail, resulting in possible tube failure, which could cause you to lose control and fall. Replace a patched tube as soon as possible.

5. Service

⚠ WARNING: Technological advances have made bicycles and bicycle components more complex, and the pace of innovation is increasing. It is impossible for this manual to provide all the information required to properly repair and/or maintain your bicycle. In order to help minimize the chances of an accident and possible injury, it is critical that you have any repair or maintenance which is not specifically described in this manual performed by your dealer. Equally important is that your individual maintenance requirements will be determined by everything from your riding style to geographic location. Consult your dealer for help in determining your maintenance requirements.

⚠ WARNING: Many bicycle service and repair tasks require special knowledge and tools. Do not begin any adjustments or service on your bicycle until you have learned from your dealer how to properly complete them. Improper adjustment or service may result in damage to the bicycle or in an accident which can cause serious injury or death.

If you want to learn to do major service and repair work on your bike:

1. Ask your dealer for copies of the manufacturer's installation and service instructions for the components on your bike, or contact the component manufacturer.
2. Ask your dealer to recommend a book on bicycle repair.
3. Ask your dealer about the availability of bicycle repair courses in your area.

We recommend that you ask your dealer to check the quality of your work the first time you work on something and before you ride the bike, just to make sure that you did everything correctly. Since that will require the time of a mechanic, there may be a modest charge for this service.

We also recommend that you ask your dealer for guidance on what spare parts, such as tires, inner tubes, light bulbs, batteries, Pach Kit, lubricants etc. it would be appropriate for you to have once you have learned how to replace such parts when they require replacement.

A. Service Intervals

Some service and maintenance can and should be performed by the owner, and require no special tools or knowledge beyond what is presented in this manual.

The following are examples of the type of service you should perform yourself. All other service, maintenance and repair should be performed in a properly equipped facility by a qualified bicycle mechanic using the correct tools and procedures specified by the manufacturer.

1. Break-in Period: Your bike will last longer and work better if you break it in before riding it hard. Control cables and wheel spokes may stretch or "seat" when a new bike is first used and may require readjustment by your dealer. Your Mechanical Safety Check (Section 1.C) will help you identify some things that need readjustment. But even if everything seems fine to you, it's best to take your bike back to the dealer for a checkup. Dealers typically suggest you bring the bike in for a 30 day checkup. Another way to judge when it's time for the first checkup is to bring the bike in after three to five hours of hard off-road use, or about 10 to 15 hours of on-road or more casual off-road use. But if you think something is wrong with the bike, take it to your dealer before riding it again.
2. Before every ride: Mechanical Safety Check (Section 1.C)
3. After every long or hard ride; if the bike has been exposed to water or grit; or at least every 100 miles: Clean the bike and lightly lubricate the chain's rollers with a good quality bicycle chain lubricant. Wipe off excess lubricant with a lint-free cloth. Lubrication is a function of climate. Talk to your dealer about the best lubricants and the recommended lubrication frequency for your area.
4. After every long or hard ride or after every 10 to 20

hours of riding:

- Squeeze the front brake and rock the bike forward and back. Everything feel solid? If you feel a clunk with each forward or backward movement of the bike, you probably have a loose headset. Have your dealer check it.
- Lift the front wheel off the ground and swing it from side to side. Feel smooth? If you feel any binding or roughness in the steering, you may have a tight headset. Have your dealer check it.
- Grab one pedal and rock it toward and away from the centerline of the bike; then do the same with the other pedal. Anything feel loose? If so, have your dealer check it.
- Take a look at the brake pads. Starting to look worn or not hitting the wheel rim squarely? Time to have the dealer adjust or replace them.
- Carefully check the control cables and cable housings. Any rust? Kinks? Fraying? If so, have your dealer replace them.
- Squeeze each adjoining pair of spokes on either side of each wheel between your thumb and index finger. Do they all feel about the same? If any feel loose, have your dealer check the wheel for tension and trueness.
- Check the tires for excess wear, cuts or bruises. Have your dealer replace them if necessary.
- Check the wheel rims for excess wear, dings, dents and scratches. Consult your dealer if you see any rim damage.
- Check to make sure that all parts and accessories are still secure, and tighten any which are not.
- Check the frame, particularly in the area around all tube joints; the handlebars; the stem; and the seatpost for any deep scratches, cracks or discoloration. These are signs of stress-caused fatigue and indicate that a part is at the end of its useful life and needs to be replaced. See also Appendix B.



WARNING: Like any mechanical device, a bicycle and its components are subject to wear and stress.

Different materials and mechanisms wear or fatigue from stress at different rates and have different life cycles. If a component's life cycle is exceeded, the component can suddenly and catastrophically fail, causing serious injury or death to the rider. Scratches, cracks, fraying and discoloration are signs of stress-caused fatigue and indicate that a part is at the end of its useful life and needs to be replaced. While the materials and workmanship of your bicycle or of individual components may be covered by a warranty for a specified period of time by the manufacturer, this is no guarantee that the product will last the term of the warranty. Product life is often related to the kind of riding you do and to the treatment to which you submit the bicycle. The bicycle's warranty is not meant to suggest that the bicycle cannot be broken or will last forever. It only means that the bicycle is covered subject to the terms of the warranty. Please be sure to

read **Appendix A, Intended Use of your bicycle and Appendix B, The lifespan of your bike and its components, starting on page 28.**

5. As required: If either brake lever fails the Mechanical Safety Check (Section 1.C), don't ride the bike. Have your dealer check the brakes.

If the chain won't shift smoothly and quietly from gear to gear, the derailleur is out of adjustment. See your dealer.

6. Every 25 (hard off-road) to 50 (on-road) hours of riding: Take your bike to your dealer for a complete checkup.

B. If your bicycle sustains an impact:

First, check yourself for injuries, and take care of them as best you can. Seek medical help if necessary.

Next, check your bike for damage.

After any crash, take your bike to your dealer for a thorough check. Carbon composite components, including frames, wheels, handlebars, stems, cranksets, brakes, etc. which have sustained an impact *must not* be ridden until they have been disassembled and thoroughly inspected by a qualified mechanic.

See also *Appendix B, Lifespan of your bike and its components.*

 **WARNING: A crash or other impact can put extraordinary stress on bicycle components, causing them to fatigue prematurely. Components suffering from stress fatigue can fail suddenly and catastrophically, causing loss of control, serious injury or death.**

Appendix A Intended use of your bicycle

 **WARNING: Understand your bike and its intended use. Choosing the wrong bicycle for your purpose can be hazardous. Using your bike the wrong way is dangerous.**

No one type of bicycle is suited for all purposes. Your retailer can help you pick the "right tool for the job" and help you understand its limitations. There are many types of bicycles and many variations within each type. There are many types of mountain, road, racing, hybrid, touring, cyclocross and tandem bicycles.

There are also bicycles that mix features. For example, there are road/racing bikes with triple cranks. These bikes have the low gearing of a touring bike, the quick handling of a racing bike, but are not well suited for carrying heavy loads on a tour. For that purpose you want a touring bike.

Within each of type of bicycle, one can optimize for certain purposes. Visit your bicycle shop and find someone with expertise in the area that interests you. Do your own homework. Seemingly small changes such as the choice of tires can improve or diminish the performance of a bicycle for a certain purpose.

On the following pages, we generally outline the intended uses of various types of bikes.

Industry usage conditions are generalized and evolving. Consult your dealer about how you intend to use your bike. "If your bike is equipped like legally required it might be used like explained in the following:"



High-Performance Road CONDITION 1

Bikes designed for riding on a paved surface where the tires do not lose ground contact.

INTENDED To be ridden on paved roads only.

NOT INTENDED For off-road, cyclocross, or touring with racks or panniers.

TRADE OFF Material use is optimized to deliver both light weight and specific performance. You must understand that (1) these types of bikes are intended to give an aggressive racer or competitive cyclist a performance advantage over a relatively short product life, (2) a less aggressive rider will enjoy longer frame life, (3) you are choosing light weight (shorter frame life) over more frame weight and a longer frame life, (4) you are choosing light weight over more dent resistant or rugged frames that weigh more. All frames that are very light need frequent inspection. These frames are likely to be damaged or broken in a crash. They are not designed to take abuse or be a rugged workhorse. See also *Appendix B.*

MAXIMUM WEIGHT LIMIT

RIDER	LUGGAGE*	TOTAL
<i>lbs / kg</i>	<i>lbs / kg</i>	<i>lbs / kg</i>
275 / 125	10 / 4.5	285 / 129.5

* Seat Bag / Handlebar Bag Only



General Purpose Riding CONDITION 2

Bikes designed for riding Condition 1, plus smooth gravel roads and improved trails with moderate grades where the tires do not lose ground contact.

INTENDED For paved roads, gravel or dirt roads that are in good condition, and bike paths.

NOT INTENDED For off-road or mountain bike use, or for any kind of jumping. Some of these bikes have suspension features, but these features are designed to add comfort, not off-road capability. Some come with relatively wide tires that are well suited to gravel or dirt paths. Some come with relatively narrow tires that are best suited to faster riding on pavement. If you ride on gravel or dirt paths, carry heavier loads or want more tire durability talk to your dealer about wider tires.

MAXIMUM WEIGHT LIMIT

RIDER	LUGGAGE	TOTAL
<i>lbs / kg</i>	<i>lbs / kg</i>	<i>lbs / kg</i>
300 / 136	30 / 14	330 / 151
for Touring or Trekking		
300 / 136	55 / 25	355 / 161



Cross-Country, Marathon, Hardtails CONDITION 3

Bikes designed for riding Conditions 1 and 2, plus rough trails, small obstacles, and smooth technical areas, including areas where momentary loss of tire contact with the ground may occur. NOT jumping. All mountain bikes without rear suspension are Condition 3, and so are some lightweight rear suspension models.

INTENDED For cross-country riding and racing which ranges from mild to aggressive over intermediate terrain (e.g., hilly with small obstacles like roots, rocks, loose surfaces and hard pack and depressions). Cross-country

and marathon equipment (tires, shocks, frames, drive trains) are light-weight, favoring nimble speed over brute force. Suspension travel is relatively short since the bike is intended to move quickly on the ground.

NOT INTENDED For Hardcore Freeriding, Extreme Downhill, Dirt Jumping, Slopestyle, or very aggressive or extreme riding. No spending time in the air landing hard and hammering through obstacles.

TRADE OFF Cross-Country bikes are lighter, faster to ride uphill, and more nimble than All-Mountain bikes. Cross-Country and Marathon bikes trade off some ruggedness for pedaling efficiency and uphill speed.

TRADE OFF Cross-Country bikes are lighter, faster to ride uphill, and more nimble than All-Mountain bikes. Cross-Country and Marathon bikes trade off some ruggedness for pedaling efficiency and uphill speed.

MAXIMUM WEIGHT LIMIT

RIDER	LUGGAGE*	TOTAL
<i>lbs / kg</i>	<i>lbs / kg</i>	<i>lbs / kg</i>
300 / 136	5 / 2.3	305 / 138
* Seat Bag Only		
Front suspension frames manufactured with original equipment seat stay and dropout rack mounts only		
300 / 136	55 / 25	355 / 161



All Mountain CONDITION 4

Bikes designed for riding Conditions 1, 2, and 3, plus rough technical areas, moderately sized obstacles, and small jumps.

INTENDED For trail and uphill riding. All-Mountain bicycles are: (1) more heavy duty than cross country bikes, but less heavy duty than Freeride bikes, (2) lighter and more nimble than Freeride bikes, (3) heavier and have more suspension travel than a cross country bike, allowing them to be ridden in more difficult terrain, over larger obstacles and moderate jumps, (4) intermediate in suspension travel and use components that fit the intermediate intended use, (5) cover a fairly wide range of intended use, and within this range are models that are more or less heavy duty. Talk to your retailer about your needs and these models.

NOT INTENDED For use in extreme forms of jumping/riding such as hardcore mountain, Freeriding, Downhill, North Shore, Dirt Jumping, Hucking etc. No large drop offs, jumps or launches (wooden structures, dirt embankments) requiring long suspension travel or heavy duty components; and no spending time in the air landing hard and hammering through obstacles.

TRADE OFF All-Mountain bikes are more rugged than cross country bikes, for riding more difficult terrain. All-Mountain bikes are heavier and harder to ride uphill than

cross country bikes. All-Mountain bikes are lighter, more nimble and easier to ride uphill than Freeride bikes. All-Mountain bikes are not as rugged as Freeride bikes and must not be used for more extreme riding and terrain.

MAXIMUM WEIGHT LIMIT

RIDER	LUGGAGE*	TOTAL
<i>lbs / kg</i>	<i>lbs / kg</i>	<i>lbs / kg</i>
300 / 136	5 / 2.3	305 / 138

* Seat Bag Only



**Gravity, Freeride, and Downhill
CONDITION 5**

Bikes designed for jumping, hucking, high speeds, or aggressive riding on rougher surfaces, or landing on flat surfaces. However, this type of riding is extremely hazardous and puts unpredictable forces on a bicycle which may overload the frame, fork, or parts. If you choose to ride in Condition 5 terrain, you should take appropriate safety precautions such as more frequent bike inspections and replacement of equipment. You should also wear comprehensive safety equipment such as a full-face helmet, pads, and body armor.

INTENDED For riding that includes the most difficult terrain that only very skilled riders should attempt.

Gravity, Freeride, and Downhill are terms which describe hardcore mountain, north shore, slopestyle. This is “extreme” riding and the terms describing it are constantly evolving.

Gravity, Freeride, and Downhill bikes are: (1) heavier and have more suspension travel than All-Mountain bikes, allowing them to be ridden in more difficult terrain, over larger obstacles and larger jumps, (2) the longest in suspension travel and use components that fit heavy duty intended use. While all that is true, there is no guarantee that extreme riding will not break a Freeride bike.

The terrain and type of riding that Freeride bikes are designed for is inherently dangerous. Appropriate equipment, such as a Freeride bike, does not change this reality. In this kind of riding, bad judgment, bad luck, or riding beyond your capabilities can easily result in an accident, where you could be seriously injured, paralyzed or killed.

NOT INTENDED To be an excuse to try anything. Read Section 2. F, p. 10.

TRADE OFF Freeride bikes are more rugged than All-Mountain bikes, for riding more difficult terrain. Freeride bikes are heavier and harder to ride uphill than All-

Mountain bikes.

MAXIMUM WEIGHT LIMIT

RIDER	LUGGAGE*	TOTAL
<i>lbs / kg</i>	<i>lbs / kg</i>	<i>lbs / kg</i>
300 / 136	5 / 2.3	305 / 138

* Seat Bag Only



**Dirt Jump
CONDITION 5**

Bikes designed for jumping, hucking, high speeds, or aggressive riding on rougher surfaces, or landing on flat surfaces. However, this type of riding is extremely hazardous and puts unpredictable forces on a bicycle which may overload the frame, fork, or parts. If you choose to ride in Condition 5 terrain, you should take appropriate safety precautions such as more frequent bike inspections and replacement of equipment. You should also wear comprehensive safety equipment such as a full-face helmet, pads, and body armor.

INTENDED For man-made dirt jumps, ramps, skate parks other predictable obstacles and terrain where riders need and use skill and bike control, rather than suspension. Dirt Jumping bikes are used much like heavy duty BMX bikes.

A Dirt Jumping bike does not give you skills to jump. Read Section 2. F, p. 10.

NOT INTENDED For terrain, drop offs or landings where large amounts of suspension travel are needed to help absorb the shock of landing and help maintain control.

TRADE OFF Dirt Jumping bikes are lighter and more nimble than Freeride bikes, but they have no rear suspension and the suspension travel in the front is much shorter.

MAXIMUM WEIGHT LIMIT

RIDER	LUGGAGE	TOTAL
<i>lbs / kg</i>	<i>lbs / kg</i>	<i>lbs / kg</i>
300 / 136	0	300 / 136



**Cyclo-cross
CONDITION 2**

Bikes designed for riding Condition 1, plus smooth gravel roads and improved trails with moderate grades where the tires do not lose ground contact plus cyclo cross courses.

INTENDED For cyclo-cross riding, training and racing. Cyclo-cross involves riding on a variety of terrain and surfaces including dirt or mud surfaces. Cyclo-cross bikes also work well for all weather rough road riding and commuting.

NOT INTENDED For off road or mountain bike use, or jumping. Cyclo-cross riders and racers dismount before reaching an obstacle, carry their bike over the obstacle and then remount. Cyclo-cross bikes are not intended for mountain bike use. The relatively large road bike size wheels are faster than the smaller mountain bike wheels, but not as strong.

MAXIMUM WEIGHT LIMIT

RIDER	LUGGAGE	TOTAL
<i>lbs / kg</i>	<i>lbs / kg</i>	<i>lbs / kg</i>
300 / 136	30 / 13.6	330 / 150



**Road Tandems
CONDITION 1**

Bikes designed for riding on a paved surface where the tires do not lose ground contact.

INTENDED Are designed to be ridden on paved roads only. They are not designed for mountain biking or off-road use.

NOT INTENDED Road tandem should not be taken off-road or used as a mountain tandem.

MAXIMUM WEIGHT LIMIT

RIDER	LUGGAGE	TOTAL
<i>lbs / kg</i>	<i>lbs / kg</i>	<i>lbs / kg</i>
500 / 227	75 / 34	575 / 261



**Mountain Tandems
CONDITION 2**

Bikes designed for riding Condition 1, plus smooth gravel roads and improved trails with moderate grades where the tires do not lose ground contact.

INTENDED The challenges of mountain biking are obvious. The added challenges of tandem riding mean that you should limit off-road tandem riding to easy-moderate terrain.

NOT INTENDED For very aggressive mountain bike riding. Mountain tandems are most definitely NOT for Downhill, Freeriding, North Shore. Choose terrain with the abilities of both the Tandem's captain and stoker in mind.

MAXIMUM WEIGHT LIMIT

RIDER	LUGGAGE	TOTAL
<i>lbs / kg</i>	<i>lbs / kg</i>	<i>lbs / kg</i>
500 / 227	75 / 34	575 / 261

Appendix B

The lifespan of your bike and its components

1. Nothing Lasts Forever, Including Your Bike.

When the useful life of your bike or its components is over, continued use is hazardous.

Every bicycle and its component parts have a finite, limited useful life. The length of that life will vary with the construction and materials used in the frame and components; the maintenance and care the frame and components receive over their life; and the type and amount of use to which the frame and components are subjected. Use in competitive events, trick riding, ramp riding, jumping, aggressive riding, riding on severe terrain, riding in severe climates, riding with heavy loads, commercial activities and other types of non-standard use can dramatically shorten the life of the frame and components. Any one or a combination of these conditions may result in an unpredictable failure.

All aspects of use being identical, lightweight bicycles and their components will usually have a shorter life than heavier bicycles and their components. In selecting a lightweight bicycle or components you are making a tradeoff, favoring the higher performance that comes with lighter weight over longevity. So, If you choose lightweight, high performance equipment, be sure to have it inspected frequently.

You should have your bicycle and its components checked periodically by your dealer for indicators of stress and/or potential failure, including cracks, deformation, corrosion, paint peeling, dents, and any other indicators of potential problems, inappropriate use or abuse. These are important safety checks and very important to help prevent accidents, bodily injury to the rider and shortened product life.

2. Perspective

Today's high-performance bicycles require frequent and careful inspection and service. In this Appendix we try to explain some underlying material science basics and how they relate to your bicycle. We discuss some of the trade-offs made in designing your bicycle and what you can expect from your bicycle; and we provide important, basic guidelines on how to maintain and inspect it. We cannot teach you everything you need to know to properly inspect and service your bicycle; and that is why we repeatedly urge you to take your bicycle to your dealer for professional care and attention.



WARNING: Frequent inspection of your bike is important to your safety. Follow the Mechanical Safety Check in Section 1.C of this Manual before every ride.

Periodic, more detailed inspection of your bicycle is important. How often this more detailed inspection is needed depends upon you.

You, the rider/owner, have control and knowledge of how often you use your bike, how hard you use it and where you use it. Because your dealer cannot track your use, you must take responsibility for periodically bringing your bike to your dealer for inspection and service. Your dealer will help you decide what frequency of inspection and service is appropriate for how and where you use your bike.

For your safety, understanding and communication with your dealer, we urge you to read this Appendix in its entirety. The materials used to make your bike determine how and how frequently to inspect.

Ignoring this WARNING can lead to frame, fork or other component failure, which can result in serious injury or death.

A. Understanding metals

Steel is the traditional material for building bicycle frames. It has good characteristics, but in high performance bicycles, steel has been largely replaced by aluminum, carbon fibre and some titanium. The main factor driving this change is interest by cycling enthusiasts in lighter bicycles.

Properties of Metals

Please understand that there is no simple statement that can be made that characterizes the use of different metals for bicycles. What is true is how the metal chosen is applied is much more important than the material alone. One must look at the way the bike is designed, tested, manufactured, supported along with the characteristics of the metal rather than seeking a simplistic answer.

Metals vary widely in their resistance to corrosion. Steel must be protected or rust will attack it. Aluminum and Titanium quickly develop an oxide film that protects the metal from further corrosion. Both are therefore quite resistant to corrosion. Aluminum is not perfectly corrosion resistant, and particular care must be used where it contacts other metals and galvanic corrosion can occur.

Metals are comparatively ductile. Ductile means bending, buckling and stretching before breaking. Generally speaking, of the common bicycle frame building materials steel is the most ductile, titanium less ductile, followed by aluminum.

Metals vary in density. Density is weight per unit of material. Steel weighs 7.8 grams/cm³ (grams per cubic centimeter), titanium 4.5 grams/cm³, aluminum 2.75 grams/cm³. Contrast these numbers with carbon fiber composite at 1.45 grams/cm³.

Metals are subject to fatigue. With enough cycles of use, at high enough loads, metals will eventually develop

cracks that lead to failure. It is very important that you read The basics of metal fatigue below.

Let's say you hit a curb, ditch, rock, car, another cyclist or other object. At any speed above a fast walk, your body will continue to move forward, momentum carrying you over the front of the bike. You cannot and will not stay on the bike, and what happens to the frame, fork and other components is irrelevant to what happens to your body.

What should you expect from your metal frame? It depends on many complex factors, which is why we tell you that crashworthiness cannot be a design criteria. With that important note, we can tell you that if the impact is hard enough the fork or frame may be bent or buckled. On a steel bike, the steel fork may be severely bent and the frame undamaged. Aluminum is less ductile than steel, but you can expect the fork and frame to be bent or buckled. Hit harder and the top tube may be broken in tension and the down tube buckled. Hit harder and the top tube may be broken, the down tube buckled and broken, leaving the head tube and fork separated from the main triangle.

When a metal bike crashes, you will usually see some evidence of this ductility in bent, buckled or folded metal.

It is now common for the main frame to be made of metal and the fork of carbon fiber. See *Section B, Understanding composites* below. The relative ductility of metals and the lack of ductility of carbon fiber means that in a crash scenario you can expect some bending or bucking in the metal but none in the carbon. Below some load the carbon fork may be intact even though the frame is damaged. Above some load the carbon fork will be completely broken.

The basics of metal fatigue

What to look for

• ONCE A CRACKS STARTS IT CAN GROW AND GROW FAST. Think about the crack as forming a pathway to failure. This means that any crack is potentially dangerous and will only become more dangerous.	SIMPLE RULE 1 : If you find crack, replace the part.
• CORROSSION SPEEDS DAMAGE. Cracks grow more quickly when they are in a corrosive environment. Think about the corrosive solution as further weakening and extending the crack.	SIMPLE RULE 2 : Clean your bike, lubricate your bike, protect your bike from salt, remove any salt as soon as you can. Repair cracks in the paint or powder coating.
• STAINS AND DISCOLORATION CAN OCCUR NEAR A CRACK. Such staining may be a warning sign that a crack exists.	SIMPLE RULE 3 : Inspect and investigate any staining to see if it is associated with a crack.
• SIGNIFICANT SCRATCHES, GOUGES, DENTS OR SCORING CREATE STARTING POINTS FOR CRACKS. Think about the cut surface as a focal point for stress (in fact engineers call such areas "stress risers," areas where the stress is increased). Perhaps you have seen glass cut? Recall how the glass was scored and then broke on the scored line.	SIMPLE RULE 4 : Do not scratch, gouge or score any surface. If you do, pay frequent attention to this area or replace the part.
• SOME CRACKS (particularly larger ones) MAY MAKE CREAKING NOISE AS YOU RIDE. Think about such a noise as a serious warning signal. Note that a well-maintained bicycle will be very quiet and free of creaks and squeaks.	SIMPLE RULE 5 : Investigate and find the source of any noise. It may not be a crack, but whatever is causing the noise should be fixed promptly.

Common sense tells us that nothing that is used lasts forever. The more you use something, and the harder you use it, and the worse the conditions you use it in, the shorter its life.

Fatigue is the term used to describe accumulated damage to a part caused by repeated loading. To cause fatigue damage, the load the part receives must be great enough. A crude, often-used example is bending a paper clip back and forth (repeated loading) until it breaks. This simple definition will help you understand that fatigue has nothing to do with time or age. A bicycle in a garage does not fatigue. Fatigue happens only through use.

So what kind of "damage" are we talking about? On a microscopic level, a crack forms in a highly stressed area. As the load is repeatedly applied, the crack grows. At some point the crack becomes visible to the naked eye. Eventually it becomes so large that the part is too weak to carry the load that it could carry without the crack. At that point there can be a complete and immediate failure of the part.

One can design a part that is so strong that fatigue life is nearly infinite. This requires a lot of material and a lot of weight. Any structure that must be light and strong will have a finite fatigue life. Aircraft, race cars, motorcycles all have parts with finite fatigue lives. If you wanted a bicycle with an infinite fatigue life, it would weigh far more than any bicycle sold today. So we all make a tradeoff: the wonderful, lightweight performance we want requires that we inspect the structure.

In most cases a fatigue crack is not a defect. It is a sign that the part has been worn out, a sign the part has reached the end of its useful life. When your car tires wear down to the point that the tread bars are contacting the road, those tires are not defective. Those tires are worn out and the tread bar says “time for replacement.” When a metal part shows a fatigue crack, it is worn out. The crack says “time for replacement.”

Fatigue Is Not A Perfectly Predictable Science

Fatigue is not a perfectly predictable science, but here are some general factors to help you and your dealer determine how often your bicycle should be inspected. The more you fit the “shorten product life” profile, the more frequent your need to inspect. The more you fit the “lengthen product life” profile, the less frequent your need to inspect.

Factors that shorten product life:

- ▶ **Hard, harsh riding style**
- ▶ **“Hits”, crashes, jumps, other “shots” to the bike**
- ▶ **High mileage**
- ▶ **Higher body weight**
- ▶ **Stronger, more fit, more aggressive rider**
- ▶ **Corrosive environment (wet, salt air, winter road salt, accumulated sweat)**
- ▶ **Presence of abrasive mud, dirt, sand, soil in riding environment**

Factors that lengthen product life:

- ▶ **Smooth, fluid riding style**
- ▶ **No “hits”, crashes, jumps, other “shots” to the bike**
- ▶ **Low mileage**
- ▶ **Lower body weight**
- ▶ **Less aggressive rider**
- ▶ **Non-corrosive environment (dry, salt-free air)**
- ▶ **Clean riding environment**



WARNING: Do not ride a bicycle or component with any crack, bulge or dent, even a small one. Riding a cracked frame, fork or component could lead to complete failure, with risk of serious injury or death.

B. Understanding composites

All riders must understand a fundamental reality of composites. Composite materials constructed of carbon fibers are strong and light, but when crashed or overloaded, carbon fibers do not bend, they break.

What Are Composites?

The term “composites” refers to the fact that a part or parts are made up of different components or materials. You’ve heard the term “carbon fiber bike.” This really means “composite bike.”

Carbon fiber composites are typically a strong, light fiber in a matrix of plastic, molded to form a shape. Carbon composites are light relative to metals. Steel weighs 7.8 grams/cm³ (grams per cubic centimeter), titanium 4.5 grams/cm³, aluminum 2.75 grams/cm³. Contrast these numbers with carbon fiber composite at 1.45 grams/cm³.

The composites with the best strength-to-weight ratios are made of carbon fiber in a matrix of epoxy plastic. The epoxy matrix bonds the carbon fibers together, transfers load to other fibers, and provides a smooth outer surface. The carbon fibers are the “skeleton” that carries the load.

Why Are Composites Used?

Unlike metals, which have uniform properties in all directions (engineers call this isotropic), carbon fibers can be placed in specific orientations to optimize the structure for particular loads. The choice of where to place the carbon fibers gives engineers a powerful tool to create strong, light bicycles. Engineers may also orient fibers to suit other goals such as comfort and vibration damping.

Carbon fiber composites are very corrosion resistant, much more so than most metals.

Think about carbon fiber or fiberglass boats.

Carbon fiber materials have a very high strength-to-weight ratio.

What Are The Limits Of Composites?

Well designed “composite” or carbon fiber bicycles and components have long fatigue lives, usually better than their metal equivalents.

While fatigue life is an advantage of carbon fiber, you must still regularly inspect your carbon fiber frame, fork, or components.

Carbon fiber composites are not ductile. Once a carbon structure is overloaded, it will not bend; it will break. At and near the break, there will be rough, sharp edges and maybe delamination of carbon fiber or carbon fiber fabric layers. There will be no bending, buckling, or stretching.

If You Hit Something Or Have A Crash, What Can You Expect From Your Carbon Fiber Bike?



WARNING: Defects and cracks in composites might appear without being visible! If you have had a crash, ear unusual noises or feel a difference while riding, let your dealer check the bike or the part. Don’t continue the ride before having the bike or part being checked!

Let’s say you hit a curb, ditch, rock, car, other cyclist or other object. At any speed above a fast walk, your body will continue to move forward, the momentum carrying you over the front of the bike. You cannot and will not stop on the bike and what happens to the frame, fork and other

components is irrelevant to what happens to your body.

What should you expect from your carbon frame? It depends on many complex factors. But we can tell you that if the impact is hard enough, the fork or frame may be completely broken. Note the significant difference in behavior between carbon and metal. See *Section 2. A, Understanding metals* in this Appendix. Even if the carbon frame was twice as strong as a metal frame, once the carbon frame is overloaded it will not bend, it will break completely.

 **WARNING:** Be aware that high temperature in a confined environment can affect the integrity of composite materials, resulting in component failure which could cause you to lose control and fall. This begins at temperatures like in a car, standing in bright sunlight for a while!

Inspection of Composite Frame, Fork, and Components Cracks:

Inspect for cracks, broken, or splintered areas. Any crack is serious. Do not ride any bicycle or component that has a crack of any size. **Delamination:**

 **WARNING:** Delaminations in composites might appear without being visible! If you have had a crash, ear unusual noises or feel a difference while riding, let your dealer check the bike or the part. Don't continue the ride before having the bike or part being checked!

Delamination is serious damage. Composites are made from layers of fabric. Delamination means that the layers of fabric are no longer bonded together. Do not ride any bicycle or component that has any delamination. These are some delamination clues:

1. • A cloudy or white area. This kind of area looks different from the ordinary undamaged areas. Undamaged areas will look glassy, shiny, or "deep," as if one was looking into a clear liquid. Delaminated areas will look opaque and cloudy.
2. • Bulging or deformed shape. If delamination occurs, the surface shape may change. The surface may have a bump, a bulge, soft spot, or not be smooth and fair.
3. • A difference in sound when tapping the surface. If you gently tap the surface of an undamaged composite you will hear a consistent sound, usually a hard, sharp sound. If you then tap a delaminated area, you will hear a different sound, usually duller, less sharp.

Unusual Noises:

Either a crack or delamination can cause creaking noises while riding. Think about such a noise as a serious warning signal. A well maintained bicycle will be very

quiet and free of creaks and squeaks. Investigate and find the source of any noise. It may not be a crack or delamination, but whatever is causing the noise must be fixed or replaced before riding.

 **WARNING: Do not ride a bicycle or component with any delamination or crack. Riding a delaminated or cracked frame, fork or other component could lead to complete failure, with risk of serious injury or death.**

C. Understanding components

It is often necessary to remove and disassemble components in order to properly and carefully inspect them. This is a job for a professional bicycle mechanic with the special tools, skills and experience to inspect and service today's high-tech high-performance bicycles and their components.

Aftermarket "Super Light" components

Think carefully about your rider profile as outlined above. The more you fit the "shorten product life" profile, the more you must question the use of super light components. The more you fit the "lengthen product life" profile, the more likely it is that lighter components may be suitable for you. Discuss your needs and your profile very honestly with your dealer.

Take these choices seriously and understand that you are responsible for the changes.

A useful slogan to discuss with your dealer if you contemplate changing components is "Strong, Light, Cheap –pick two."

Original Equipment components

Bicycle and component manufacturers tests the fatigue life of the components that are original equipment on your bike. This means that they have met test criteria and have reasonable fatigue life. It does not mean that the original components will last forever. They won't.

Appendix C

Coaster Brake

1. How the coaster brake works

The coaster brake is a sealed mechanism which is a part of the bicycle's rear wheel hub. The brake is activated by reversing the rotation of the pedal cranks (see fig. 5). Start with the pedal cranks in a nearly horizontal position, with the front pedal in about the 4 o'clock position, and apply downward foot pressure on the pedal that is to the rear. About 1/8 turn rotation will activate the brake. The more downward pressure you apply, the more braking force, up to the point where the rear wheel stops rotating and begins to skid.



WARNING: Before riding, make sure that the brake is working properly. If it is not working properly, have the bicycle checked by your dealer before you ride it.



WARNING: If your bike has only a coaster brake, ride conservatively. A single rear brake does not have the stopping power of front-and-rear brake systems.

2. Adjusting your coaster brake

Coaster brake service and adjustment requires special tools and special knowledge. Do not attempt to disassemble or service your coaster brake. Take the bicycle to your dealer for coaster brake service.

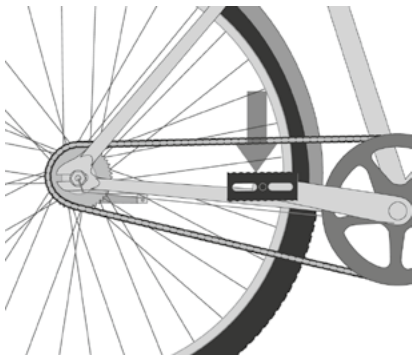

fig. 5

Appendix D

Fastener Torque Specifications

Correct tightening torque of threaded fasteners is very important to your safety. Always tighten fasteners to the correct torque. In case of a conflict between the instructions in this manual and information provided by a component manufacturer, consult with your dealer or the manufacturer's customer service representative for clarification. Bolts that are too tight can stretch and deform. Bolts that are too loose can move and fatigue. Either mistake can lead to a sudden failure of the bolt.

Always use a correctly calibrated torque wrench to tighten critical fasteners on your bike. Carefully follow the torque wrench manufacturer's instructions on the correct way to set and use the torque wrench for accurate results.

FASTENER RECOMMENDED TORQUE

WHEELS

PEDALS

SEAT POST CLAMP

SADDLE CLAMP

STEERER CLAMP

HANDLEBAR CLAMP

CONTROL LEVER CLAMPS

Active Line

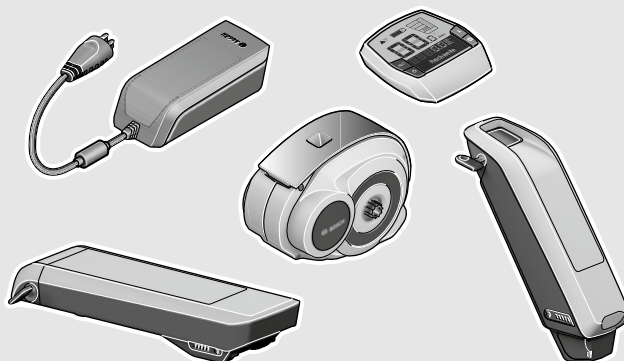

Owner's Manual – The Bosch Drive System

Drive Unit | Intuvia | PowerPack | Charger

0 275 007 029 | 1 270 020 906 | 0 275 007 526 | 0 275 007 906



BOSCH

en Original instructions

This manual contains important safety, performance and service information. Read and understand it along with the information provided to you by your bicycle manufacturer before using the product, and keep it for reference.

Age: 16+



Introduction	3
General Warnings	3
Using your Operator's Manual	3
Bosch Drive System Overview	4
Bicycle View (Standard)	4
Bicycle View (Rack-Type)	5
Component View (On-board Computer/Operating Unit/Drive Unit) ...	6
Component View (Battery Pack "PowerPack")	7
Component View (Charger)	8
On-Product Warning Labels	9
Operating your Bosch Drive System	10
Getting Ready to Ride	10
Safe Start-Up Procedure	10
Operation	11
Transport	16
Maintenance/Cleaning	17
Storing	18
Bosch Drive System Components	19
Drive Unit/On-board Computer Intuvia	19
Lithium-Ion Battery Pack "PowerPack"	23
Charger	28
Troubleshooting	32
Battery Recycling Program	35

Introduction

Thank You for Purchasing a Bosch Drive System Equipped Bicycle!

Your Bosch eBike system team appreciates having you as a customer and wishes you many years of safe and satisfied use of your bicycle.

General Warnings



Read all safety warnings and all instructions.

Failure to follow the warnings and instructions may result in death or serious injury.

Save all safety warnings and instructions for future reference.

The term “battery pack” used in these operating instructions refers both to standard battery packs (battery packs with holder on the bike frame) and to rack-type battery packs (battery packs with holder in the rear rack/carrier).

About Warnings

This manual contains many “**DANGER**”, “**WARNING**”, and “**CAUTION**” indicators concerning the consequences of failing to use, assemble, maintain, store, inspect and dispose of a Bosch-equipped eBike in a safe manner.

The combination of the safety alert symbol and the word “**DANGER**” indicates a hazardous situation that, if not avoided, **will** result in death or serious injury.

The combination of the safety alert symbol and the word “**WARNING**” indicates a hazardous situation that, if not avoided, **could** result in death or serious injury.

The combination of the safety alert symbol and the word “**CAUTION**” indicates a hazardous situation that, if not avoided, could result in minor or moderate injury.

▲ WARNING

- ▶ **The Bosch Drive System is intended for use by persons 16 years of age and older.** Riders must have the physical coordination, reaction and mental capabilities to control a bike and manage traffic, road conditions, and sudden situations, and also to respect the laws and instructions governing bicycle use.
- ▶ **This manual contains important safety, performance and service information.** Read it before you take the first ride on your new bicycle, and keep it for reference. The manual can also be found online at www.bosch-ebike.com.

▶ **This manual is intended to be read together with the separate user manual provided with your bicycle.** Be sure to read all provided documents including labels on the product before your first ride.

▶ **Read ALL accompanying manuals before riding the bike for the first time.** Your Bosch Drive System comes with additional manuals and documents provided by the manufacturer of the bicycle and other components. Failure to read and understand safety information can result in death or serious injury.

▶ **Take responsibility for your own SAFETY.** If you have any questions or do not understand something, contact your Bosch eBike dealer or the bicycle or component manufacturer.

▶ **Some eBike accessories may present a choking hazard to small children.** Keep these accessories away from children.

▲ CAUTION

▶ **The Bosch Drive System adds weight to your bicycle which you may not be used to lifting.** Avoid injury; use proper lifting techniques.

Using your Operator’s Manual

Graphics

The bicycle shown in this manual may differ slightly from your bicycle, but will be similar enough to help you understand our instructions.

RIGHT-HAND and LEFT-HAND sides are determined by facing in the direction the bicycle will travel when going forward. When you see a broken line (-----), the item referred to is hidden from view.

Bosch Drive System Overview

Bicycle View (Standard)

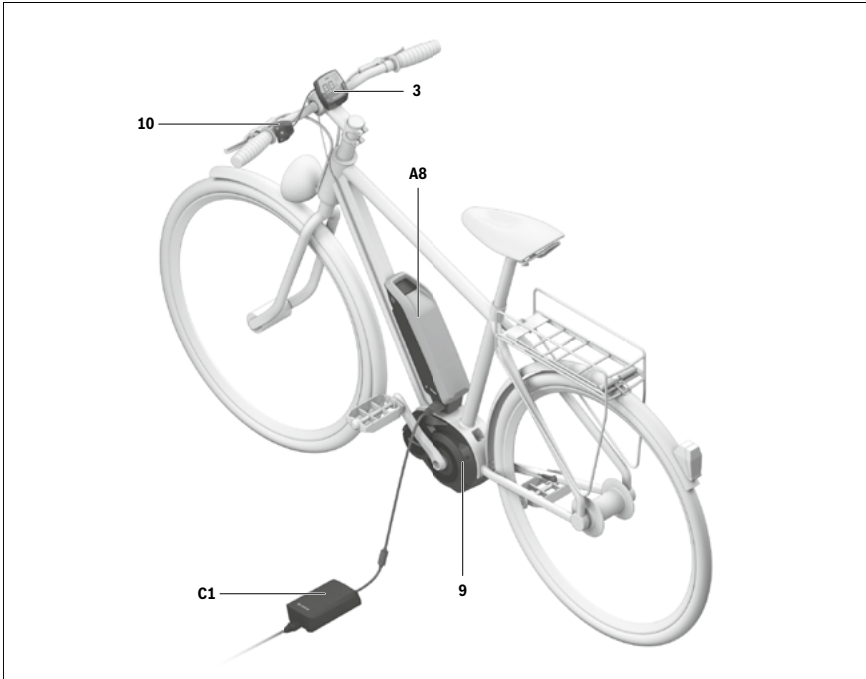

Bosch Drive System Components

All representations of bike components, with the exception of the eBike components, are schematic and can deviate from your eBike.

- 3** On-board computer Intuvia
- 9** Drive unit
- 10** Operating unit
- A8** Standard battery pack "PowerPack"
- C1** Battery charger

Bicycle View (Rack-Type)

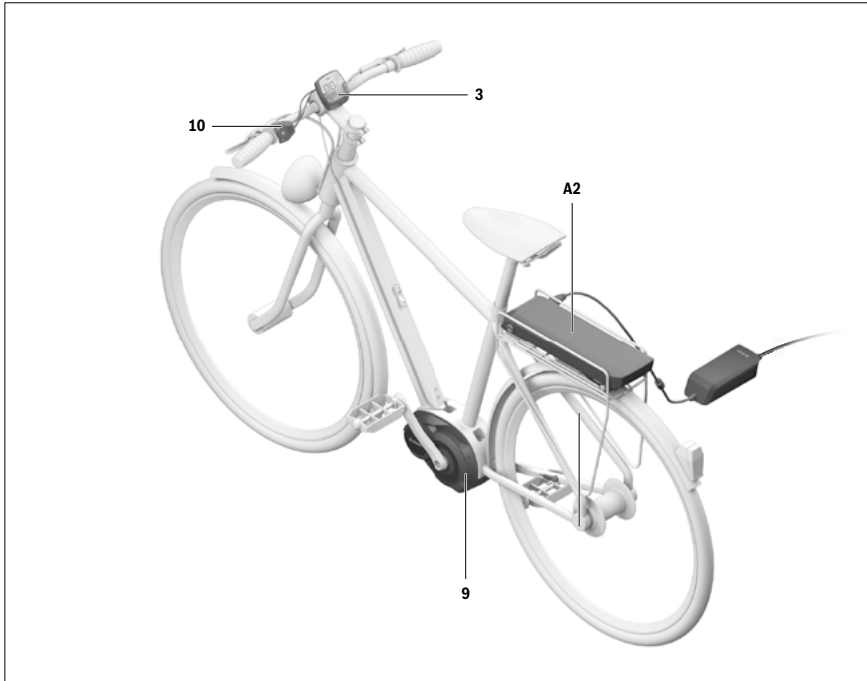

Bosch Drive System Components

All representations of bike components, with the exception of the eBike components, are schematic and can deviate from your eBike.

- 3 On-board computer Intuvia
- 9 Drive unit
- 10 Operating unit
- A2 Rack-type battery pack "PowerPack"

Component View (On-board Computer/Operating Unit/Drive Unit)

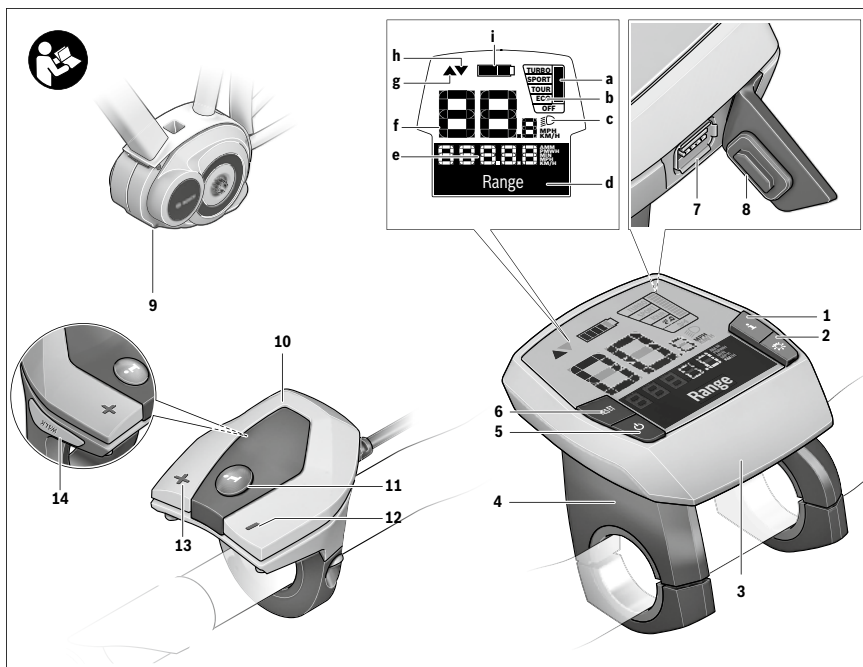

Product Features

- 1 Display function button "i"
- 2 "Light" button
- 3 On-board computer Intuvia
- 4 Holder for on-board computer Intuvia
- 5 On/Off button for on-board computer
- 6 "RESET" button
- 7 USB port
- 8 Protective cap for USB port
- 9 Drive unit
- 10 Operating unit
- 11 Display function button "i" on the operating unit
- 12 Reduce assistance/scroll down button "-"
- 13 Increase assistance/scroll up button "+"
- 14 Push assistance button "WALK"

*Not executable in some countries

On-board Computer Information

- a Drive unit assistance indicator
- b Assistance level indicator
- c Light indicator
- d Text indicator
- e Value indicator
- f Speed indicator
- g Shift recommendation: higher gear
- h Shift recommendation: lower gear
- i Battery charge-control indicator

Component View (Battery Pack “PowerPack”)

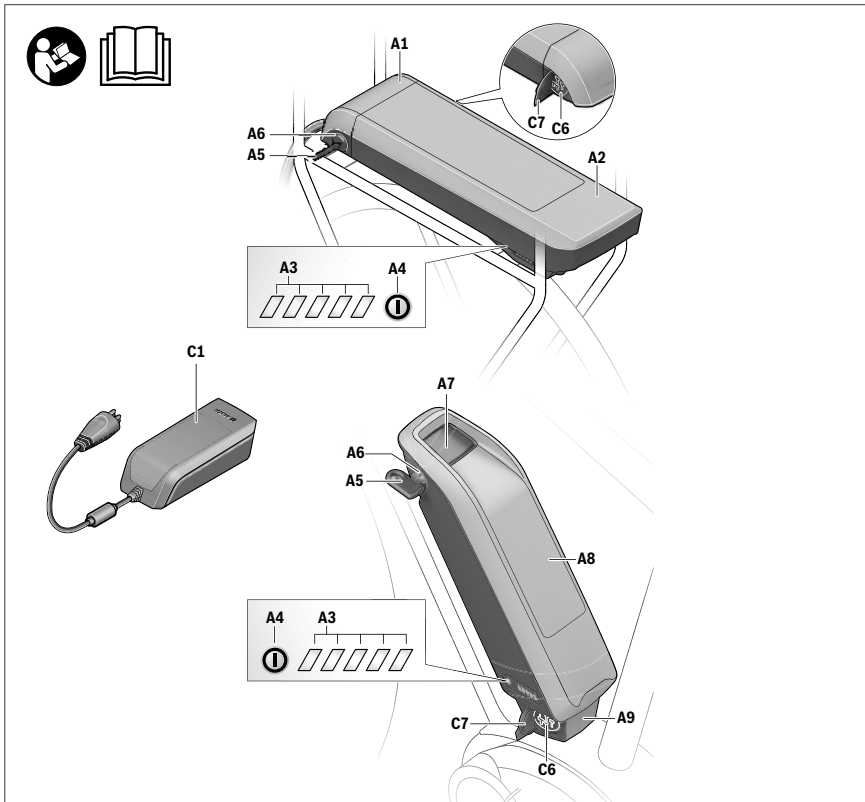

Product Features

All representations of bike components, with the exception of the battery packs and their holders, are schematic and can deviate from your eBike.

A1 Holder for the rack-type battery pack

A2 Rack-type battery pack

A3 Operation and charge-control indicator

A4 On/Off button

A5 Key for the battery pack lock

A6 Battery pack lock

A7 Upper holder for the standard battery pack

A8 Standard battery pack

A9 Bottom holder for the standard battery pack

C1 Battery charger

C6 Socket for charge connector

C7 Charge socket cover

Component View (Charger)

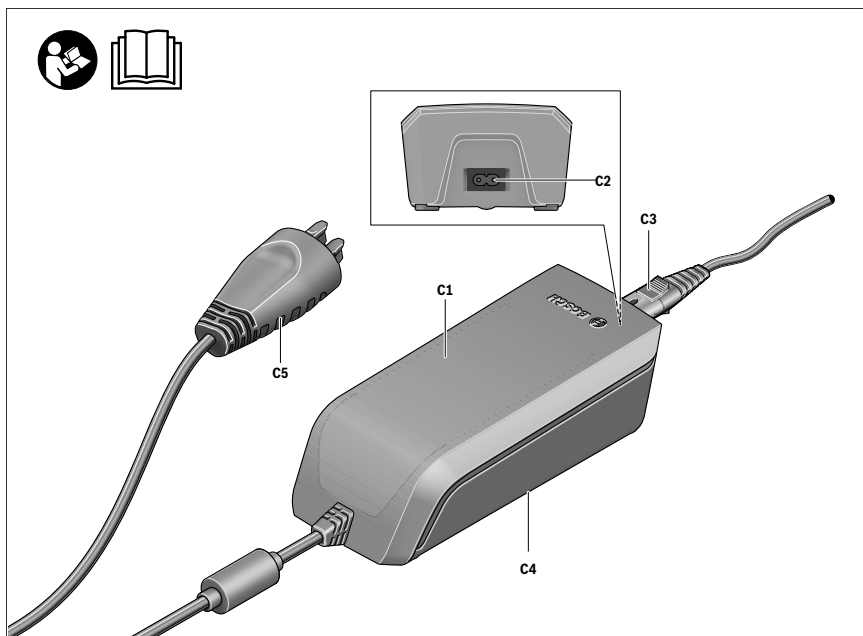

Product Features

- C1** Battery charger
- C2** Charger socket
- C3** Plug-in connector
- C4** Safety warnings, charger
- C5** Charge connector

On-Product Warning Labels

A

eBike Battery Charger 36-4/100-230
0 275 007 906

Input: 110V-230V ~ 50-60Hz 2.2A
 Output: 30V= 4A

Made in PRC
 Robert Bosch GmbH, Reutlingen

UL US
 BATTERY CHARGER
 6470342

BPF
 135593

CE
 SI

This device complies with part 15 of the FCC Rules. Operation is subject to the following two conditions: (1) This device may not cause harmful interference, and (2) this device must accept any interference received, including interference that may cause undesired operation. For safe operation see manual. Risk of electric shock. Indoor use only. Charge only batteries of the Bosch eBike Systems. Other batteries may burst causing personal damage. Do not replace the plug assembly as risk of fire or electric shock may result.

⚠ WARNING Para un funcionamiento con seguridad, ver el manual Peligro de sacudida eléctrica. Utilice otras baterías podrían reventar, causando lesiones personales y daños. No reemplace el ensamblaje del enchufe, ya que el resultado puede ser riesgo de incendio o sacudidas eléctricas.



⚠ ADVERTENCIA Para un funcionamiento sûr, reportez-vous au manuel. Risque de choc électrique. Utilisez en lieu sûr uniquement. A utiliser uniquement avec les batteries des systèmes d'assistance électrique eBike de Bosch. D'autres batteries risqueraient d'éclater et de causer des blessures corporelles et des dommages. Ne pas remplacer la connectique car un risque d'incendie ou de choc électrique pourrait en résulter.

B

 **⚠ WARNING No User Serviceable Parts, Do NOT Open**
 • Read and understand owner's manual before using

 **⚠ WARNING Avoid Serious Injury or Death**
 • Remove battery when using vehicle bike rack!
 • Remove battery before performing bike inspection \ repair!

 **⚠ DANGER Explosion**
 • Do NOT expose above 140°F (60°C).
 • Do NOT crush or puncture!

- A Safety warnings, charger
 B Safety warnings, "PowerPack"

- **Warning labels have been placed on the Bosch Drive System for your protection. Read and follow the instructions of the labels on the product carefully. If a label becomes illegible or comes off, contact your Bosch bicycle dealer to obtain a replacement. Replacement safety labels are provided by Bosch at no charge.**

Operating your Bosch Drive System

Getting Ready to Ride

⚠ WARNING

- ▶ **Read and understand all safety warnings and instructions.** Failure to follow the warnings below could result in death or serious injury.
- ▶ **Protect others from death or serious injury. Prevent unauthorized use.** Always remove the on-board computer or battery from the bicycle when not in use and store in a secure location. Failure to secure your bicycle from unauthorized use can result in death or serious injury to others.

Before your first ride

Check your bicycle owner's manual for important information about the bike components, such as brakes, pedals, gears, shifting equipment, etc.

⚠ WARNING

- ▶ **While riding, do not become distracted by the on-board computer and always remain alert to all riding situations.** The on-board computer should only be used in a stationary and safe start-up position. Use the operating unit to change motor assistance levels while riding.
- ▶ **Check your bicycle manual for the maximum riding weight of your bicycle.** Overloading your bicycle can result in component failure, which can result in death or serious injury. Typically, the maximum riding weight is defined by the sum of the rider's weight plus the weight of any luggage.

Intended Use

⚠ WARNING

- ▶ **Understand your bike and its intended use by checking your bicycle owner's manual.** Using your bike the wrong way and for a purpose for which it was not designed can result in death or serious injury.

The Bosch Drive System components are intended exclusively for your eBike and may not be used for other purposes. Your Bosch Drive unit is not intended for towing another bicycle. For trailer towing, check your bicycle owner's manual and the trailer owner's manual for towing instructions and towing compatibility.

Safe Start-Up Procedure

⚠ WARNING

- ▶ **Follow the safe start-up procedure below.** Failure to follow the safe start-up procedure can result in death or serious injury.

Preparations

Before starting, check the following:

- Check that you have unplugged the battery charger
- Your battery pack is locked in place (pull on the battery pack to ensure it is locked in place)
- Remove the battery pack key

Start Riding

- Sit in the saddle with both feet touching the ground and both hands on the handlebars.
- Once you are in a stable position, turn on the Bosch on-board computer. The Bosch Drive System will always start-up in the "OFF" mode.
- Place both hands on the handlebars and begin pedaling.

Operation

Initial Operation

Switching the eBike System On/Off

Options for **switching on** the eBike system:

- If the on-board computer is already switched on when inserted into the holder, then the eBike system will be switched on automatically.
- When the on-board computer and the eBike battery pack are inserted, briefly press the On/Off button **5** of the on-board computer once.
- When the on-board computer is inserted, press the On/Off button on the battery pack.

Once it is switched on, the eBike system is in the **“OFF”** mode. Select the desired assistance level and take off.

The drive is activated as soon as you put pressure on the pedals. The assistance level depends upon the on-board computer settings.

As soon as the system is activated, **“Active Line”** appears briefly on the display.

As soon as you stop pedaling when in normal operation, or as soon as you have reached a speed of 20 mph, the assistance from the eBike drive unit is switched off. The motor assistance is automatically re-activated as soon you start pedaling again and the speed is below 20 mph.

Options for **switching off** the eBike system:

- Press the On/Off button **5** of the on-board computer.
- Switch the eBike battery pack off by using its On/Off button (see battery pack operating instructions.)
- Remove the on-board computer out of its holder.

If the eBike is not moved **and** no button is pressed on the on-board computer for 10 minutes, the eBike system will shut down automatically in order to save energy.



eShift (optional)

eShift is the integration of automatic gear shifting systems into the eBike system. To support the rider in the best way possible, the function indications and the basic settings menu have been adapted for the **“eShift”** function.

eShift with NuVinci H|Sync

The optimum gear for the respective speed is automatically set according to a pre-defined desired cadence. In manual mode you can choose between multiple gears.

In the **“NuVinci Cadence”** mode you can use the **“–”** or **“+”** button on the operating unit to increase or decrease the desired cadence. If you hold down the **“–”** or **“+”** button, the cadence will increase or decrease in steps of five. The desired cadence is shown on the display.

In the **“NuVinci Gear”** mode you can use the **“–”** or **“+”** button on the operating unit to switch back and forth between several defined transmission ratios. The engaged transmission ratio (gear) is shown on the display.

eShift with SRAM DD3 Pulse

The gear hub of the SRAM DD3 Pulse works on a speed-dependent basis. Regardless of which gear is engaged on the derailleur gears, one of the three gears of the gear hub will automatically be engaged (“**Autom. Gear Selection**”).

The engaged gear will be shown briefly on the display whenever the gear of the gear hub is shifted.

If the eBike is brought to a standstill from a speed of more than 6 mph, the system can automatically switch back to a set “**starting gear**”. The “**starting gear**” can be set in the basic settings menu (see “Displaying/Adapting Basic Settings” on page English – 14).

In the “**Gear**” mode you can use the “-” or “+” button on the operating unit to switch back and forth between several defined transmission ratios. The engaged transmission ratio (gear) is shown on the display.

In the “**Gear**” manual mode, the system can also automatically switch back to a set “**starting gear**”.

The drive unit recognizes the gear shift and briefly reduces the motor assistance level as a result of it, which means the gear can also be shifted at any time under load or on a hill.

eShift with Shimano Di2

For Shimano eShift you use the Shimano control lever to shift gears.

The engaged gear will be shown briefly on the display whenever the gear of the gear hub is shifted.

The drive unit recognizes the gear shift and briefly reduces the motor assistance level as a result of it, which means the gear can also be shifted at any time under load or on a hill.

If the eBike is brought to a standstill from a speed of more than 6 mph, the system can automatically switch back to a set “**starting gear**”. The “**starting gear**” can be set in the basic settings menu (see “Displaying/Adapting Basic Settings” on page English – 14).

Indications and Settings of the on-board computer

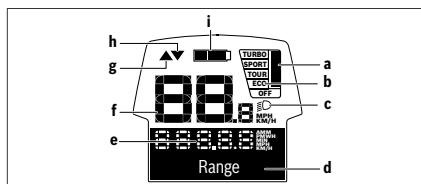

Switching the on-board computer On/Off

To **switch on** the on-board computer, briefly press the On/Off button **5**. When the internal battery pack is sufficiently charged, the on-board computer can also be switched on when not inserted in the holder.

To **switch off** the on-board computer, press the On/Off button **5**.

When the on-board computer is not inserted in the holder and no button is pressed, it automatically switches off after 1 min to save energy.

► **If you do not use your eBike for several weeks, remove the on-board computer from its holder.** Store the on-board computer in a dry environment at room temperature. Regularly recharge the on-board computer's battery pack.

Battery charge-control indicator

The battery pack charge-control indicator **i** indicates the charge condition of the eBike's battery pack, and not the charge condition of the on-board computer's internal battery. The charge condition of the eBike's battery pack can also be read from the battery pack's LEDs.

On indicator **i**, each bar of the battery pack symbol is equivalent to a capacity of approx. 20 %:

▣▣▣▣: The eBike battery is fully charged.

▣▣▣▢: The eBike battery should be recharged.

▣▣▣▢: Once there are no remaining LED bars illuminated on the charge-control indicator, the motor support is gently switched off and the charge-control indicator begins to flash. The flashing charge-control indicator means there is only enough battery power remaining to power the eBike lights for approximately 2 more hours. This does not account for other consumers (e.g., automatic gearbox, charging external devices at the USB port).

When the on-board computer is removed from holder **4**, the last indicated battery pack charge condition is stored.

Setting the Assistance Level

The level of assistance of the eBike drive unit when pedaling can be adjusted via the operating unit **10**. The assistance level can be changed anytime, even during riding.

Note: For individual versions, it is possible that the assistance level is preset and cannot be changed. It is also possible that fewer assistance levels are available for selection than listed here.

The following assistance levels (max.) are available:

- **“OFF”**: The motor assistance is switched off, the eBike can be operated as a normal bicycle through pedaling.
- **“ECO”**: Effective assistance at maximum efficiency for maximum cruising range
- **“TOUR”**: Uniform assistance, for touring with long cruising range
- **“SPORT”**: Powerful assistance for sporty off-road riding, as well as for urban traffic
- **“TURBO”**: Maximum assistance, supporting the highest speed for sporty riding

To **increase** the assistance level, press the **“+”** button **13** on the operating unit until the desired assistance level is displayed in indicator **b**; to **decrease** the assistance level, press the **“-”** button **12**.

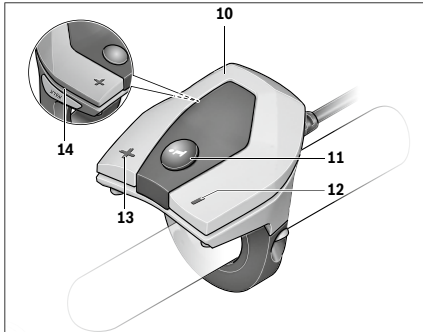

The requested motor output is displayed in indicator **a**. The maximum motor output depends on the selected assistance level.

Assistance Level	Assistance Factor* (Deraillieur)
“ECO”	40 %
“TOUR”	100 %
“SPORT”	150 %
“TURBO”	250 %

* The motor output can vary for individual versions.

When the on-board computer is removed from the holder **4**, then the last indicated level is **not** stored and the on-board computer is reset to the **“OFF”** mode.

Once it is switched on, the eBike system is in the **“OFF”** mode.

Back-pedaling function (optional)

If the push assistance is switched on, the pedals will also rotate on bikes with back-pedaling function. If the rotating pedals are blocked, the push assistance will be switched off.

Switching bike lights On/Off

If your lights are set up to be powered by the eBike system, then you can use the **2** button on the on-board computer to simultaneously switch both the front light and the rear light on and off.

When the lighting is switched on, **“Lights on”** appears, and when the lighting is switched off, **“Lights off”** appears for approx. 1 s in the text indicator **d**. The light symbol **c** is displayed when the light is on.

Switching the driving light on and off has no effect on the backlighting for the display. The backlighting for the display is active as soon as the system or the display is switched on.

Speed and Distance Indicator



The **speed indicator f** always displays the current speed.



The following functions are available in the **function indicator** (combination of text indicator **d** and value indicator **e**):

- **“Clock”**: Current time
- **“Max. speed”**: Maximum speed achieved since the last reset
- **“Avg. speed”**: Average speed achieved since the last reset
- **“Trip time”**: Trip time since the last reset
- **“Range”**: Estimated range of the available battery pack charge (for constant conditions such as assistance level, route profile, etc.)

- **“Odometer”**: Display of the total distance traveled with the eBike (cannot be reset)
- **“ NuVinci Cadence/Gear”**: This menu item is displayed only in conjunction with a Nu Vinci H|Sync automatic transmission.

If you press the “**i**” button for longer than 1 s, you will access the NuVinci menu item from any menu item in the information menu.

To switch from the “** NuVinci Cadence**” mode to the “** NuVinci Gear**” mode, press the “**i**” button for 1 s.

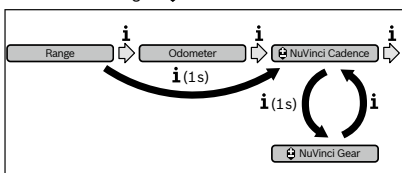

To switch from the “** NuVinci Gear**” mode to the “** NuVinci Cadence**” mode, all you have to do is briefly press the “**i**” button.

The default setting is “** NuVinci Cadence**”.

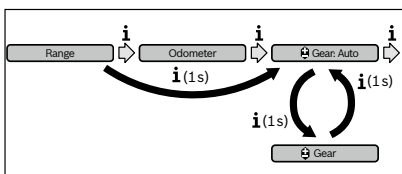

- **“Gear”**: This menu item appears only in conjunction with a Shimano-Di2 gear hub. The currently engaged gear of the transmission is shown on the display. The newly engaged gear will be shown briefly on the display whenever the gear is shifted.
- **“ Autom. Gear Selection”**: This menu item appears only in conjunction with an SRAM automatic transmission.



By pressing the “**i**” button for more than 1 s, you can switch back and forth between the “** Autom. Gear Selection**” automatic mode and the “** Gear**” manual mode.

If you are in first gear in manual mode, you can also press the “**-**” 12 button to go to the “** Autom. Gear Selection**” mode. By pressing the “**-**” 12 button again, you can switch back to the manual mode. It is also possible to access the manual mode by pressing the “**+**” 13 button.

- **“Trip distance”**: Distance covered since the last reset

To **switch between the indication functions**, press the “**i**” button **1** on the on-board computer or the “**i**” button **11** on the operating unit until the desired function is displayed.

To **reset “Trip distance”, “Trip time” and “Avg. speed”**, switch to any of the three functions and then press and hold the “**RESET**” button **6** until the indicator is set to zero. This also resets the values for the other two functions.

To **reset the “Max. speed”**, switch to this function and then press and hold the “**RESET**” button **6** until the indicator is set to zero.

To **reset “Range”**, switch to this function and then press the “**RESET**” **6** button until the display is reset to the value of the factory setting.

When the on-board computer is removed from the holder **4**, all function values remain stored and can be viewed.

Displaying/Adapting Basic Settings

The basic settings can be displayed and changed regardless of whether the on-board computer is inserted in the holder **4** or not. Some settings are visible and changeable only when the operating computer is inserted. Some menu items may be missing depending on the equipment of your eBike.

To access the basic settings menu, press and hold the “**RESET**” button **6** and the “**i**” button **1** until “**Configurati**on” is displayed in text indicator **d**.

To **switch between the basic settings**, press the “**i**” button **1** on the on-board computer until the desired basic setting is displayed. When the on-board computer is inserted in holder **4**, you can also press the “**i**” button **11** on the operating unit.

To **change the basic settings**, press the On/Off button **5** next to the “**-**” indicator to decrease the value or scroll down, or the light button **2** next to the “**+**” indicator to increase the value or scroll up.

When the on-board computer is inserted in holder **4**, you can also change the values with the “**-**” button **12** or the “**+**” button **13** on the operating unit.

To exit the function and store a changed setting, press the “**RESET**” button **6** for 3 s.

The following basic settings are available:

- “**Clock +**”: The current time can be set here. Pressing and holding the setting buttons fast-forwards the setting speed.
- “**Wheel circum. +**”: You can change this value pre-set by the manufacturer by $\pm 5\%$. This menu item is displayed only when the on-board computer is in the holder.
- “**English +**”: You can change the language of the text indications. You can choose between German, English, French, Spanish, Italian, Portuguese, Swedish, Dutch and Danish.
- “**Unit km/mi +**”: The speed and distance can be displayed either in kilometers or miles.
- “**Time format +**”: The time can be displayed either in a 12-hour or 24-hour format.
- “**Shift recom. on/off +**”: You can switch the indication of a shift recommendation on and off.
- “**Power-on hours**”: Indicates the total travel time with the eBike (can not be changed).
- “**Gear calibration (only NuVinci H|Sync)**”: Here you can calibrate the continuously variable transmission. Confirm the calibration by pressing the “Bike lights” button. Then follow the instructions.
In the event of an error, it can also be necessary to perform calibration when riding. In this case, you also confirm the calibration by pressing the “Bike lights” button and then follow the instructions on the display.
This menu item is displayed only when the on-board computer is in the holder.
- “**Starting gear +**”: This is the starting gear which can be set when using SRAM DD3 Pulse and Shimano Di2. The automatic shift-back function is switched off in the “--” position. This menu item is displayed only in connection with SRAM DD3 Pulse and Shimano Di2. This menu item is displayed only when the on-board computer is in the holder.
- “**Displ. vx.x.x.x**”: This is the software version of the display.
- “**DU vx.x.x.x**”: This is the software version of the drive unit. This menu item is displayed only when the on-board computer is in the holder.
- “**DU #xxxxxxx**”: This is the serial number of the drive unit. This menu item is displayed only when the on-board computer is in the holder.
- “**Service MM/YYYY**”: This menu item is displayed when the bike manufacturer has set a fixed service appointment.

- “**Serv. xx km/mi**”: This menu item is displayed when the bike manufacturer has set a fixed service appointment after a certain mileage has been reached.
- “**Bat. vx.x.x.x**”: This is the software version of the battery pack. This menu item is displayed only when the on-board computer is in the holder.
- “**Gear vx.x.x.x**”: This is the software version of the automatic transmission. This menu item is displayed only when the on-board computer is in the holder. This menu item is displayed only in conjunction with an automatic transmission.

Error Code Indicator

The components of the eBike system are continuously and automatically monitored. When an error is detected, the respective error code is indicated in text indicator **d**.

To return to the standard indicator, press any button on the on-board computer **3** or on the operating unit **10**.

Depending on the type of error, the drive unit is automatically shut off, if required. Continued travel without assistance from the drive unit is possible at any time. However, have the eBike checked before attempting new trips.

► **WARNING: Have all checks and repairs performed only by an authorized Bosch eBike dealer.**

Notes on Riding with the eBike System

When does the eBike Drive Unit Operate?

The eBike drive unit assists you when riding, as long as you step on the pedals. Without pedaling, there is no assistance. The motor output always depends on the amount of your pedaling power.

When applying less pedaling power, the assistance or support will be lower than when applying a lot of pedaling power. This applies independent of the assistance level.

The eBike motor assistance automatically switches off at speeds in excess of 20 mph. When the speed falls below 20 mph, the motor assistance is automatically available again.

The eBike can also be ridden as a normal bicycle without assistance at any time, by either switching off the eBike system or setting the assistance level to “**OFF**”. The same applies when the battery pack is empty.

Interaction of the eBike System with the Bicycle Gears

The bicycle gears should be used as with a normal bicycle, even with eBike motor assistance (please follow the operating instructions for your eBike).

Independent of the type of gearing, it is recommended to briefly interrupt the pedaling while changing gears. This makes changing gears easier and reduces the wear on the drive train.

By selecting the right gear, you can increase the speed and range with the same pedaling effort.

For this reason, follow the shift recommendations provided by indications **g** and **h** on your display. If indication **g** is displayed, you should shift to a higher gear with lower cadence. If indication **h** is displayed, you should select a lower gear with higher cadence.

Test the operating range of your eBike under different conditions before planning longer and more challenging rides.

- ▶ **Read and understand the “Influences on the Operating Range” section below before planning your ride.**

Influences on the Operating Range

The operating range depends on many factors, such as the following:

- Assistance level,
- Gear-switching behavior,
- Bicycle tires and tire pressure,
- Age and condition of the battery pack,
- Route profile (inclines) and road or path conditions (road or path surface),
- Headwind and ambient temperature,
- Weight of the eBike, rider and equipment/luggage.

For this reason, it is not possible to precisely predict the range before or during a trip. General rules:

- For **the same** motor output of the eBike drive unit: the less power or force that you have to bring about to reach a certain speed (e. g., through optimal use of the gears), the less energy the eBike drive unit will consume, and the greater the range will be for a battery pack charge.
- The **higher** the assistance level under otherwise identical conditions, the shorter the range will be.

Note: Plan your routes so that you can also reach your destination each time without motor assistance.

Transport

⚠ WARNING

- ▶ **If you carry your eBike outside of your car, e.g. on a luggage rack, remove the on-board computer and the eBike battery pack in order to avoid damaging them.**
- ▶ **Always remove the battery pack from the bicycle before transporting the bicycle on a vehicle bike rack.** Failure to remove the battery pack when using a vehicle bike rack can lead to death or serious injury. The battery may detach during transport and cause an accident to following vehicles.
- ▶ **Always use an approved and compatible bicycle rack when transporting your eBike. The Bosch Drive System adds weight to the bicycle.** Refer to your bicycle rack manual to be sure your eBike is compatible. Overloading a bike rack can result in death or serious injury.
- ▶ **Use proper lifting techniques because electric bikes are generally heavier than bicycles.**

Ship batteries only when the housings are undamaged. Tape or mask off open contacts and pack up the battery in such a way that it cannot move around in the packaging. Notify your parcel service that the package contains dangerous goods. Please also follow possibly more detailed national regulations. Always check the state and federal regulations before attempting to ship your battery.

In case of questions concerning transport of the battery packs, please contact an authorized Bosch eBike dealer. Bosch eBike dealers can also provide suitable transport packaging.

Maintenance/Cleaning

▲ WARNING

- ▶ **Your Bosch Drive System components are maintenance-free.** Do not open any of the components. Service should only be carried out at an authorized Bosch eBike dealer. Failure to follow the above warning may result in death or serious injury. Refer to your bicycle manual or component manual for all non-Bosch Drive System components.
- ▶ **Always remove the battery pack before performing any bicycle inspection, maintenance or repair.** Failure to remove the battery pack before performing bicycle inspection, maintenance or repair can lead to serious injury.
- ▶ **If you suspect that something is loose, do not ride your bike.** See your Bosch eBike dealer; only a qualified service provider should perform work on your Bosch Drive System. All nuts, bolts, screws require the correct tightening force. Too little force and the fastener may not hold securely. Too much force and the fastener can stretch, deform or break, or the threads can be stripped. Either way, incorrect tightening force can result in component failure, which can cause you to lose control and fall.
- ▶ **If replacing your battery, only buy a genuine Bosch battery pack from an approved source. See your Bosch eBike dealer for original Bosch parts.**
- ▶ **Always switch the battery pack off when inserting or removing it from the holder.** Never attempt to insert or remove the battery pack while riding the bike.
- ▶ **Do not charge or use your eBike in any area with a potentially explosive atmosphere, such as at a fueling area, or in areas where the air contains chemicals or particles (such as grain, dust, or metal powders).** Obey all signs and follow all instructions.
- ▶ **Do not submerge your eBike components in water, or wash using a pressurized hose.** Your Bosch drive unit is designed to be water tight in regards to rain water and non-pressurized hose washing.
- ▶ **Note down the manufacturer and the number of the key.** In case the keys are lost, please contact an authorized Bosch eBike dealer. Please provide the name of the manufacturer and the number of the key.
- ▶ **Do not paint any components of the Bosch Drive System as this may cause premature failure of the components.**

Careful Handling of the eBike

Please observe the operating and storage temperatures for the eBike components. Protect the drive unit, on-board computer and battery pack against extreme temperatures (e.g., from intense sunlight without adequate ventilation). The components (especially the battery pack) can become damaged because of extreme temperatures.

Have your eBike undergo a technical inspection at regular intervals. When the service appointment is due, the on-board computer will inform you of this for 4 seconds in the text indication **d** by displaying “**Service**” after the on-board computer has been switched on. The bike manufacturer can base the service appointment on a mileage and/or a time period.

Please contact an authorized bicycle dealer for service or repairs to the eBike.

After Sale Service and Customer Assistance

In case of questions concerning the eBike system and its components, please contact an authorized Bosch eBike dealer.

Contact data for authorized Bosch eBike dealers can be found at www.bosch-ebike.com

When the battery pack is no longer operative, please contact an authorized Bosch eBike dealer.

Cleaning

- ▶ **Do not submerge your eBike components in water, or wash using a pressurized hose.** Your Bosch drive unit is designed to be water tight in regards to rain water and non-pressurized hose washing.

Keep all components of your eBike clean, especially the battery pack contacts and the corresponding holder contacts.

All components including the drive unit may not be immersed in water or cleaned with a high-pressure cleaner. Keep all components of your eBike clean, especially the battery pack contacts and the corresponding holder contacts. Clean them carefully with a soft, damp cloth (using only mild soap and water).

Storing

Notes for Optimum Handling of the Battery Pack

The battery pack life can be extended if properly maintained and especially if operated and stored at the right temperatures.

With increasing age, however, the battery pack capacity will diminish, even if properly maintained.

A significantly reduced operating period after charging indicates that the battery pack is worn out and must be replaced. You can replace it yourself by purchasing a genuine Bosch PowerPack from an authorized Bosch eBike dealer.

Recharging the Battery Pack Before and During Storage

When not using the battery pack for a longer period, charge it to approx. 60 % (3 to 4 LEDs lit on the charge-control indicator **A3**).

Check the charge condition after 6 months. When only one LED on the charge-control indicator **A3** lights up, recharge the battery pack again to approx. 60 %.

Note: When the battery pack is stored discharged (empty) for longer periods, it can become damaged despite the low self-discharging feature, and the battery pack capacity may be strongly reduced.

It is not recommended to have the battery pack connected permanently to the charger.

Storage Conditions

Store the battery pack in a dry, well-ventilated location. Protect the battery pack against moisture and water. Under unfavorable weather conditions, it is recommended e. g., to remove the battery pack from the eBike and store it in an enclosed location until it is used again.

The battery pack can be stored at temperatures between +14 °F and +140 °F. However, storing the battery pack at the optimal temperature of 68 °F will provide the longer battery life.

Make sure that the maximum storage temperature is not exceeded. As an example, store the battery pack out of direct sunlight and do not leave it in a vehicle during the summer. It is recommended to not store the battery pack on the bike.

Bosch Drive System Components

Drive Unit/ On-board Computer Intuvia

⚠ WARNING



Read and understand all safety warnings and instructions. Failure to follow the warnings below could result in death or serious injury.

Save all safety warnings and instructions for future reference.

The term “battery pack” used in these operating instructions refers both to standard battery packs (battery packs with holder on the bike frame) and to rack-type battery packs (battery packs with holder in the rear rack/carrier).

- ▶ **Do not open the drive unit yourself. The drive unit must be repaired only by qualified experts and only with original spare parts.** This will ensure that the safety of the drive unit is maintained. Unauthorized opening of the drive unit will void warranty claims.
- ▶ **All components attached to the drive unit and all other components of the eBike drive (e.g., the chainwheel, chainwheel seat, pedals) may be replaced only with identical components or components specifically approved for your eBike by the bicycle manufacturer.** This protects the drive unit against overload and damage.
- ▶ **Remove the battery pack from the eBike before beginning work (e.g. inspection, repair, assembly, maintenance, work on the chain, etc.) on the eBike, transporting it by car or plane, or storing it.** Unintentional activation of the eBike system poses a risk of injury.
- ▶ **The eBike system can switch itself on when the eBike is pushed backwards.**
- ▶ **Use only original Bosch battery packs approved for your eBike by the manufacturer.** Using other battery packs can lead to injuries and pose a fire hazard. When using other battery packs, the warranty is void and Bosch shall not assume any liability.
- ▶ **Do not make any modifications to your eBike system or attach any other products which would be suitable for increasing the performance of your eBike system.** Unauthorized modification of the system could result in death or serious injury.
- ▶ **Please follow all local, state and federal regulations when registering and using eBikes.**
- ▶ **Please read and follow the safety warnings and instructions provided in the operating instructions for the battery pack as well as in the operating instructions for your eBike.**

Product Description and Specifications

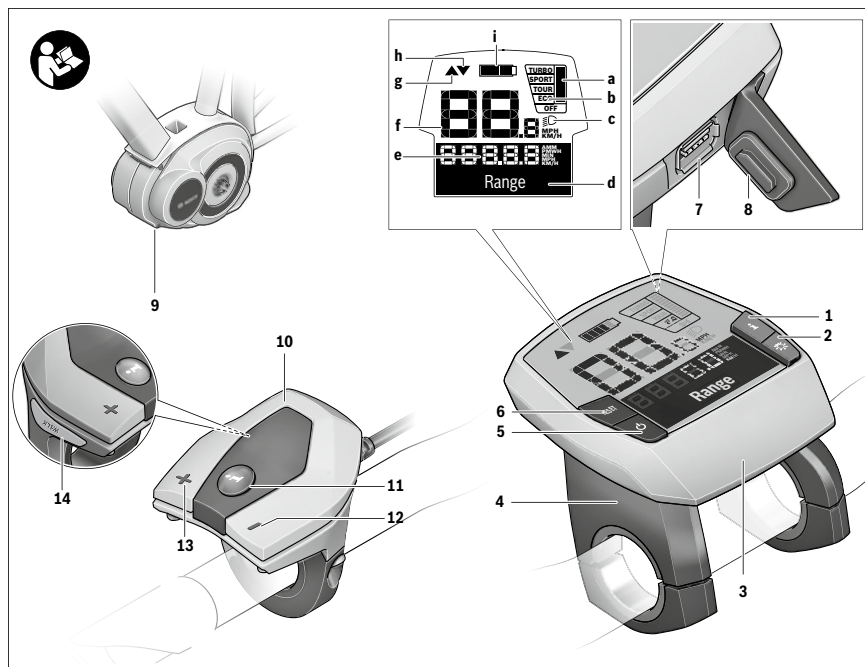

Product Features

- 1 Display function button “i”
- 2 “Light” button
- 3 On-board computer Intuvia
- 4 Holder for on-board computer Intuvia
- 5 On/Off button for on-board computer
- 6 “RESET” button
- 7 USB port
- 8 Protective cap for USB port
- 9 Drive unit
- 10 Operating unit
- 11 Display function button “i” on the operating unit
- 12 Reduce assistance/scroll down button “-”
- 13 Increase assistance/scroll up button “+”
- 14 Push assistance button “WALK”*

*Not executable in some countries

On-board Computer Information

- a Drive unit assistance indicator
- b Assistance level indicator
- c Light indicator
- d Text indicator
- e Value indicator
- f Speed indicator
- g Shift recommendation: higher gear
- h Shift recommendation: lower gear
- i Battery charge-control indicator

Technical Data

Drive unit		Drive Unit
Article number		0 275 007 029
Rated continuous power	W	250
Torque at drive, max.	Nm	50
Rated voltage	V $\overline{\text{=}}$	36
Operating temperature	°F	+23 ... +104
Storage temperature	°F	+14 ... +122
Degree of protection		IP 54 (dust and splash water protected)
Weight, appox.	lb	8.8

On-board computer		Intuvia
Article number		1 270 020 906
Max. charging current, USB connection	mA	500
Charging voltage, USB connection	V	5
Operating temperature	°F	+23 ... +104
Storage temperature	°F	+14 ... +122
Charging temperature	°F	+32 ... +104
Degree of protection		IP 54 (dust and splash water protected)
Weight, appox.	lb	0.3

This device is in compliance with Part 15 of the FCC Rules. Operation is subject to the following two conditions:

- (1) This device must not cause harmful interference, and
- (2) this device must accept any interference that is received, including interference that may cause undesired operation.

This device is in compliance with CAN ICES-3(B)/NM B-3(B).

Bosch eBike system uses FreeRTOS (see www.freertos.org)

Bike lights*		
Rated voltage	V $\overline{\text{=}}$	6
Power output		
– Front light	W	8.4
– Rear light	W	0.6

* Not possible via the eBike battery pack in all country-specific versions, depending on the statutory regulations

Assembly

Inserting and removing the battery pack

To insert or remove the battery pack in/from the eBike, please read and follow the battery pack operating instructions.

Inserting and removing the on-board computer

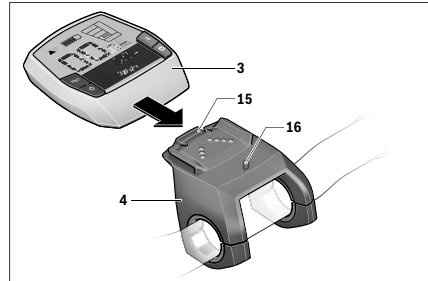

- 3** On-board computer
- 4** Holder for on-board computer
- 15** Lock latch for on-board computer
- 16** Locking screw for on-board computer

To **insert** the on-board computer **3**, slide it from the front into the holder **4**.

To **remove** the on-board computer **3**, press the lock latch **15** and slide the on-board computer toward the front out of the holder **4**.

► **Remove the on-board computer when you park the eBike.**

It is possible to secure the display unit against removal in the holder. To do so, remove the holder **4** from the handlebar. Put the display unit in the holder. Screw the locking screw **16** (thread M3, 8 mm long) from below into the thread provided in the holder. Attach the holder back onto the handlebar.

Checking the Speed Sensor

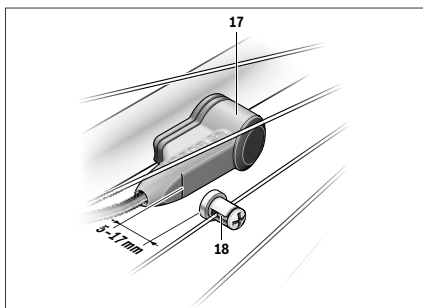

- 17** Speed sensor
18 Spoke magnet for the speed sensor

The speed sensor **17** and its spoke magnet **18** must be attached in such a way that the spoke magnet, after a turn of the wheel, moves past the speed sensor with a clearance of at least 5 mm, yet no more than 17 mm.

Note: If the clearance between the speed sensor **17** and the spoke magnet **18** is too small or too large, or if the speed sensor **17** is not properly connected, the speed indicator **f** will fail, and the eBike drive unit will operate in the emergency mode.

In this case, loosen the screw for the spoke magnet **18** and fasten the spoke magnet to the spoke in such a way that it runs past the mark of the speed sensor at the correct clearance. If the speed is still not being indicated on the speed indicator **f** after this is done, please contact an authorized Bosch eBike dealer.

Operation

Initial Operation

Requirements

The eBike system can only be activated when the following requirements are met:

- A sufficiently charged battery pack is inserted (see the operating instructions for the battery pack).
- The on-board computer is properly inserted into the holder.
- The on-board computer is properly connected.

Switching the eBike System On/Off

Options for **switching on** the eBike system:

- If the on-board computer is already switched on when inserted into the holder, then the eBike system will be switched on automatically.
- When the on-board computer and the eBike battery pack are inserted, briefly press the On/Off button **5** of the on-board computer once.
- When the on-board computer is inserted, press the On/Off button on the battery pack.

Once it is switched on, the eBike system is in the “**OFF**” mode. Select the desired assistance level and take off.

The drive is activated as soon as you put pressure on the pedals. The assistance level depends upon the on-board computer settings.

As soon as you stop pedaling when in normal operation, or as soon as you have reached a speed of 20 mph, the assistance from the eBike drive unit is switched off. The motor assistance is automatically re-activated as soon you start pedaling again and the speed is below 20 mph.

Options for **switching off** the eBike system:

- Press the On/Off button **5** of the on-board computer.
- Switch the eBike battery pack off by using its On/Off button (see battery pack operating instructions.)
- Remove the on-board computer out of its holder.

If the eBike is not moved **and** no button is pressed on the on-board computer for 10 minutes, the eBike system will shut down automatically in order to save energy.

Power Supply for External Devices via USB Connection

With the USB connection, it is possible to operate and charge most devices whose power supply is possible via a USB port (e.g., various mobile phones).

A prerequisite for the charging is that the on-board computer and a sufficiently charged battery pack are inserted in the eBike.

Open the protective cap **8** of the USB port on the on-board computer. Connect the USB connection of the external device to the USB port **7** on the on-board computer using the USB charging cable Micro A – Micro B (available from your Bosch eBike dealer).

Once the consumer has been disconnected, the USB connection must be sealed again carefully with the protective cap **8**.

- ▶ **A USB connection is not a waterproof plug-in connection. When riding in the rain, an external device must not be connected and the USB connection must be completely sealed with the protective cap 8.**

Lithium-Ion Battery Pack “PowerPack”



Read and understand all safety warnings and instructions. Failure to follow the warnings below could result in death or serious injury.

Save all safety warnings and instructions for future reference.

The term “battery pack” used in these operating instructions refers both to standard battery packs (battery packs with holder on the bike frame) and to rack-type battery packs (battery packs with holder in the rear rack/carrier), except when explicitly referring to the design type.

▲ DANGER

- ▶ **Do not puncture or crush the battery pack. Do not subject the battery pack to mechanical impacts or modify it in any way.** Do not use the battery pack if it shows visible damage. Otherwise, there is the risk of a fire or an explosion, which can cause death or serious injury.



Protect the battery pack against heat (e. g., temperature > 140 °F), fire and immersing into water. Otherwise, there is the risk of an explosion.

▲ WARNING

- ▶ **Use only original Bosch battery packs approved for your eBike by the manufacturer and purchased from a trusted source.** Use of non-approved or counterfeit battery packs can lead to death or serious injury.
- ▶ **Remove the battery pack from the eBike before beginning work (e.g. inspection, repair, assembly, maintenance, work on the chain, etc.) on the eBike, transporting it by car or plane, or storing it.** Unintentional activation of the eBike system poses a risk of injury.
- ▶ **Do not open the battery pack.** There is a risk of a short circuit. Opening the battery pack voids any and all warranty claims.

- ▶ **If it is not being used, keep the battery pack away from paper clips, coins, keys, nails, screws or other small metal objects that can make a connection from one terminal to another.** Shorting the battery pack terminals together may cause burns or a fire. For any damage caused by shorting the terminals in this way, any and all warranty claims through Bosch shall be invalid.
- ▶ **If it is abused, then liquid may be ejected from the battery pack. Avoid contact. If contact accidentally occurs, flush with water. If liquid contacts eyes, additionally seek medical help.** Liquid ejected from the battery pack may cause skin irritations or burns.
- ▶ **Battery packs must not be subjected to mechanical impacts.** There is a risk that the battery pack will be damaged causing vapors to escape. The vapors can irritate the respiratory system. Provide for fresh air and seek medical attention in case of complaints.
- ▶ **Charge the battery pack only with original Bosch battery chargers.** When using non-original Bosch chargers, the risk of fire cannot be excluded.
- ▶ **Use the battery pack only together with eBikes that have an original Bosch eBike drive system.** This is the only way to protect the battery pack against dangerous overload.
- ▶ **Use only original Bosch battery packs approved for your eBike by the manufacturer.** Using other battery packs can lead to injuries and pose a fire hazard. When using other battery packs, the warranty is void and Bosch shall not assume any liability.
- ▶ **Please read and observe the safety warnings and instructions enclosed in the operating instructions for the charger and the drive unit/on-board computer, as well as in the operating instructions for your eBike.**
- ▶ **Keep the battery pack out of reach of children.**

Product Description and Specifications

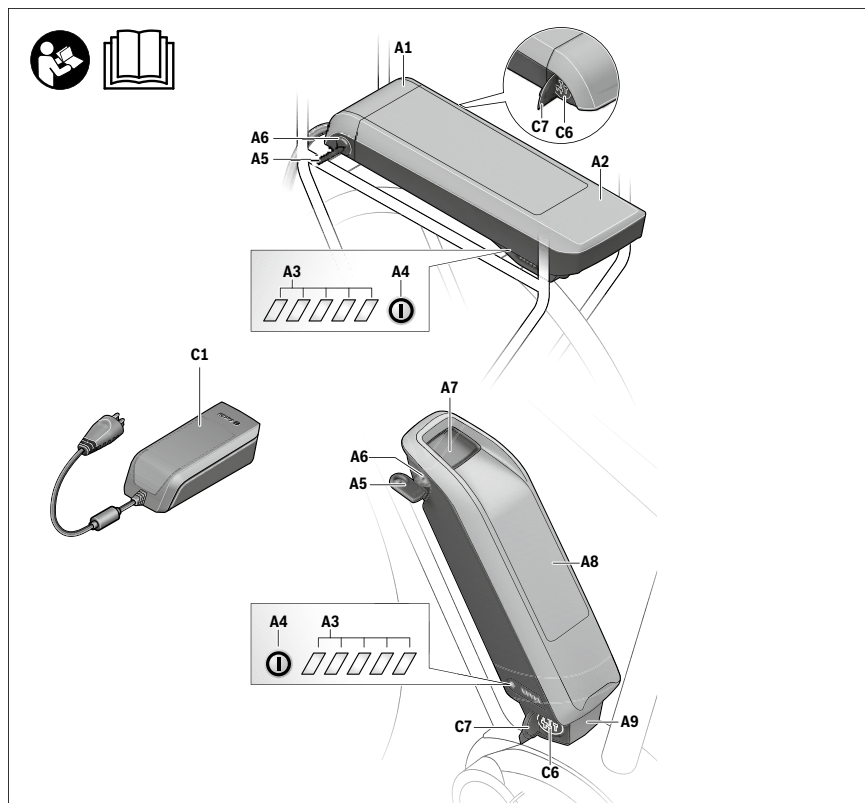

Product Features

All representations of bike components, with the exception of the battery packs and their holders, are schematic and can deviate from your eBike.

- A1** Holder for the rack-type battery pack
- A2** Rack-type battery pack
- A3** Operation and charge-control indicator
- A4** On/Off button
- A5** Key for the battery pack lock
- A6** Battery pack lock
- A7** Upper holder for the standard battery pack
- A8** Standard battery pack
- A9** Bottom holder for the standard battery pack
- C1** Battery charger
- C6** Socket for charge connector
- C7** Charge socket cover

Technical Data

Lithium-ion battery pack		PowerPack 400
Article number		
– Rack-type battery pack		0 275 007 526
Rated voltage	V=	36
Rated capacity	Ah	11
Energy	Wh	400
Operating temperature	°F	+23 ... +104
Storage temperature	°F	+14 ... +140
Permitted charging temperature range	°F	+32 ... +104
Weight, approx.	lb	5.5/5.7
Degree of protection		IP 54 (dust and splash water protected)

This device is in compliance with Part 15 of the FCC Rules. Operation is subject to the following two conditions:

- (1) This device must not cause harmful interference, and
- (2) this device must accept any interference that is received, including interference that may cause undesired operation.

This device is in compliance with CAN ICES-3(B)/NM B-3(B).

Assembly

- ▶ **Put the battery pack down only on clean surfaces.** In particular, avoid getting the charge socket and the contacts dirty, e. g., with sand or soil.

Checking the Battery Pack Before Using for the First Time

Check the battery pack before charging it or using it with your eBike for the first time.

To do this, press the On/Off button **A4** to switch on the battery pack. If no LED for the charge-control indicator **A3** lights up, then the battery pack may be damaged.

When at least one of the LEDs, but not all, for the charge-control indicator **A3** is lit, then fully charge the battery pack before using it for the first time.

- ▶ **Do not attempt to charge or use a damaged battery pack.** Please contact an authorized Bosch eBike dealer.

Charging the Battery Pack

- ▶ **Only use the Bosch charger provided with your eBike or an identical original Bosch charger.** Only this charger is matched to the lithium-ion battery pack used in your eBike.

Note: The battery pack is supplied partially charged. To ensure full battery pack capacity, completely charge the battery pack in the charger before using it for the first time.

To charge the battery pack, read and follow the operating instructions for the charger.

The battery pack can be recharged at any time on its own or on the bike without shortening its service life. Interrupting the charging process does not damage the battery pack.

The battery pack is equipped with a temperature control indicator, which enables charging only within a temperature range between 32 °F and 104 °F.

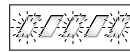

When the battery pack is not within the charging temperature range, three

LEDs of the charge-control indicator **A3** flash. Disconnect the battery pack from the charger until its temperature has adjusted.

- ▶ **CAUTION: Do not connect the battery pack to the charger until it has reached the permissible charging temperature.**

Charge-control Indicator

When the battery pack is switched on, the five green LEDs for the charge-control indicator **A3** indicate the charge condition of the battery pack.

Here, each LED indicates approx. 20 % capacity. When the battery pack is completely charged, all five LEDs light up.

The charge-control for the switched on battery pack is also indicated on the display for the on-board computer. Read and follow the operating instructions for the drive unit and the on-board computer.

When the capacity of the battery pack is below 5 %, all LEDs for the charge-control indicator **A3** on the battery pack turn off; however, the on-board computer does provide an additional indicator function.

Inserting and removing the battery pack

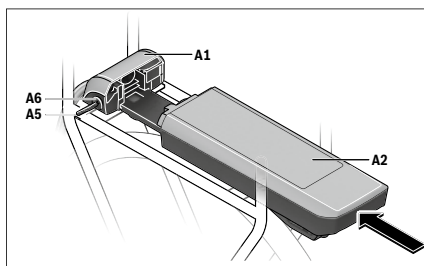
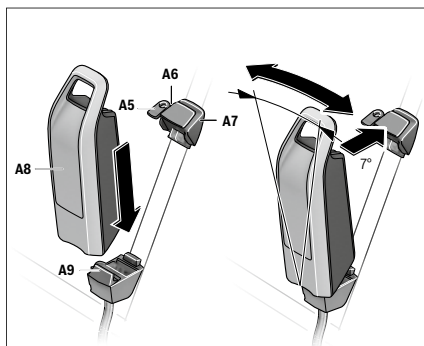

- **Always switch the battery pack off when inserting or removing it from the holder.**

In order for the battery pack to be inserted, the key **A5** must be inserted into the lock **A6** and the lock must be unlocked.

To **insert the standard battery pack A8**, place it with the contacts on the lower holder **A9** on the eBike (the battery pack can be inclined up to 7° to the frame). Tilt it into the upper holder **A7** until it engages.

To **insert the rack-type battery pack A2**, slide it with the contacts facing ahead until it engages in the holder **A1** of the rear rack/carrier.

- **Always check that the battery pack is locked in place.** To do this, pull on the battery pack handle (after the key has been removed).

Check if the battery pack is tightly seated. Always lock the battery pack with lock **A6**; otherwise the lock can open and the battery pack could fall out of the holder.

After locking, always remove the key **A5** from the lock **A6**. This prevents the key from falling out and the battery pack from being removed by unauthorized persons when the eBike is parked.

To **remove the standard battery pack A8**, switch it off and unlock the lock with the key **A5**. Tilt the battery pack out of the upper holder **A7** and pull it out of the lower holder **A9**.

To **remove the rack-type battery pack A2**, switch it off and unlock the lock with the key **A5**. Pull the battery pack out of the holder **A1**.

Operation

Initial Operation

- **Use only original Bosch battery packs approved for your eBike by the manufacturer and purchased from a trusted source.** Use of non-approved or counterfeit battery packs can lead to death or serious injury.

Switching On and Off

Switching the battery pack on is one of the ways of starting the eBike system. Read and follow the operating instructions for the drive unit and the on-board computer.

Before switching on the battery pack or the eBike system, check that the lock **A6** is locked.

To **switch on** the battery pack, press the On/Off button **A4**. The LEDs for indicator **A3** light up and, at the same time, indicate the charge condition.

- **Always check that the battery pack is locked in place.** To do this, pull on the battery pack handle (after the key has been removed).

Note: When the battery pack capacity is below 5 %, none of the LEDs for charge-control indicator **A3** will light up. Only the on-board computer will indicate if the eBike system is switched on.

To **switch off** the battery pack, press the On/Off button **A4** again. The LEDs for indicator **A3** go out. This also switches off the eBike system.

When no power output from the eBike drive unit is requested for approx. 10 minutes (e. g., because the eBike is parked) and no button for the drive on-board computer or operating unit is pressed, then the eBike system, and thus the battery pack, automatically switches off to save energy.

The battery pack is protected against deep discharging, overcharging, overheating and short-circuiting by the “Electronic Cell Protection (ECP)”. In case of hazardous situations, a protective circuit automatically switches off the battery pack.

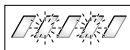

When a defect in the battery pack is detected, two LEDs for the charge-control indicator **A3** flash. In this case, please contact an authorized Bosch eBike dealer.

Charger

IMPORTANT SAFETY INSTRUCTIONS

SAVE THESE INSTRUCTIONS – This manual contains important safety and operating instructions for this battery charger.

- ▶ **Before using battery charger, read all instructions and cautionary markings on battery charger, battery, and product using battery.**
- ▶ **CAUTION:** To reduce risk of injury, charge only batteries of the Bosch eBike Systems. Other types of batteries may burst causing personal injury and damage.



Read and understand all safety warnings and instructions. Failure to follow the warnings below could result in death or serious injury.

Save all safety warnings and instructions for future reference.

The term “battery pack” used in these operating instructions refers both to standard battery packs (battery packs with holder on the bike frame) and to rack-type battery packs (battery packs with holder in the rear rack/carrier), except when explicitly referring to the design type.

▲ DANGER

- ▶ **Only charge eBike-approved Bosch lithium-ion battery packs. The battery pack voltage must match the battery pack charging voltage of the charger.** Otherwise, there is risk of fire and explosion.



Keep the charger away from rain and moisture. The penetration of water into a battery charger increases the risk of an electric shock.

▲ WARNING

- ▶ **Use only the original Bosch battery charger supplied with your eBike or one approved for your eBike by the manufacturer and purchased from a trusted source.** Bypassing the battery charger or the use of a non-approved or counterfeit battery charger can lead to death or serious injury.
- ▶ **Keep the battery charger clean.** Contamination can lead to the risk of an electric shock. Clean only with the use of a damp cloth (mild soap/water).

- ▶ **Check the battery charger, cable and plug each time before using. Do not use the battery charger when defects are detected. Do not open the battery charger yourself and have it repaired only by qualified personnel using original spare parts.** Damaged battery chargers, cables and plugs increase the risk of electric shock.
- ▶ **Do not operate the battery charger on easily flammable surfaces (e. g., paper, textiles, etc.) or in combustible environments.** There is danger of fire due to the heating of the battery charger during charging.
- ▶ **Use caution when touching the charger during the charging procedure. Wear protective gloves.** Especially in high ambient temperatures, the charger can heat up considerably.
- ▶ **Battery packs must not be subjected to mechanical impacts.** There is a risk that the battery pack will be damaged causing vapors to escape. The vapors can irritate the respiratory system. Provide for fresh air and seek medical attention in case of complaints.
- ▶ **Keep the battery charger away from children.** This will ensure that children do not play with the charger.
- ▶ **Persons who are not capable of safely operating the charger because of their physical, sensory or mental limitations, or because of their lack of experience or knowledge, may only use this charger under supervision or after having been instructed by a responsible person.** Otherwise, there is a risk of operating errors and injuries.
- ▶ **Please read and follow the safety warnings and instructions enclosed in the operating instructions for the battery pack and drive unit/on-board computer, as well as in the operating instructions for your eBike.**
- ▶ A short version of important safety warnings in English, French and Spanish with the following content can be found on the bottom side of the charger (marked with number **C4** in the representation on the graphics page, the label itself can be found in chapter “On-Product Warning Labels”):
 - For safe operation, see manual.
 - Risk of electric shock.
 - Indoor use only.
 - Charge only batteries for the Bosch eBike Systems. Other batteries may burst causing personal damage.
 - Do not replace the plug assembly as risk of fire or electric shock may result.

Product Description and Specifications

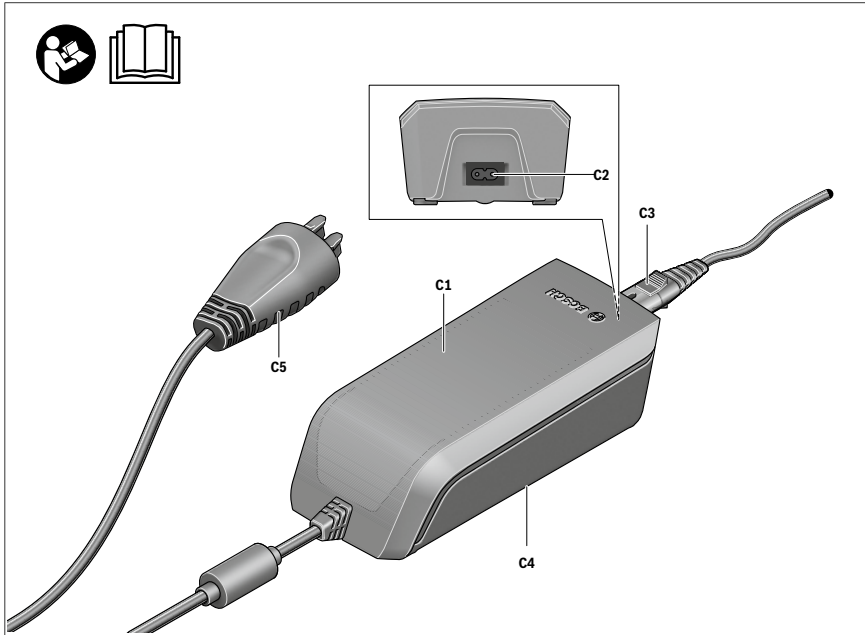

Product Features

- C1** Battery charger
- C2** Charger socket
- C3** Plug-in connector
- C5** Charge connector

Technical Data

Battery Charger		Charger
Article number		0 275 007 906
Rated voltage	V~	90...264
Frequency	Hz	47...63
Output voltage	V $\overline{-}$	36
Charging current	A	4
Charging time (PowerPack 400)	h	3.5
Operating temperature	°F	+32...+104
Storage temperature	°F	+14...+122
Weight according to EPTA-Procedure 01/2003	lb	1.8
Degree of protection		IP 40

Operation

Initial Operation

Connecting the Charger to Household Electricity

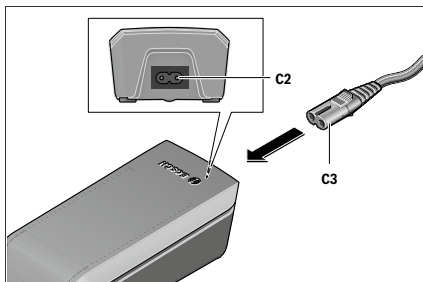

- **Note the household voltage!** The voltage of the power supply must correspond to the specifications given on the battery charger nameplate.

Plug the charger plug **C3** of the power cord into the charger socket **C2** of the charger.

Connect the power supply cable (country-specific) to the household electricity supply.

Charging the Removed Battery

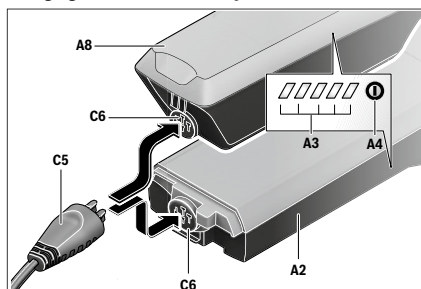

- C5** Charge connector
- C6** Socket for charge connector
- A2** Rack-type battery pack
- A3** Operation and charge-control indicator
- A4** Battery On/Off button
- A8** Standard battery pack

Switch the battery pack off and remove it from the holder of the eBike. To do this, read and follow the operating instructions for the battery pack.

- **Put the battery pack down only on clean surfaces.** In particular, avoid getting the charge socket and the contacts dirty, e. g., with sand or soil.

Insert the charger plug **C5** for the battery charger into the socket **C6** on the battery pack.

Charging the Battery on the Bike

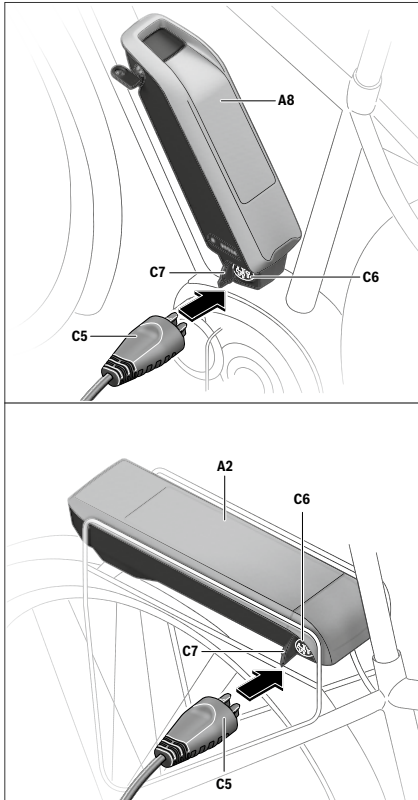

Switch the battery off. Clean the cover of the charge socket **C7**. In particular, prevent the charge socket and the contacts from getting dirty, e. g., with sand or soil. Lift the cover of the charge socket **C7** and plug the charge connector **C5** into the charge socket **C6**.

► **Charge the battery only in accordance with all safety instructions.** If this is not possible, remove the battery from the holder and charge it in a more suitable location. When doing so, read and follow the operating instructions for the battery.

Charging Procedure

The charging procedure begins as soon as the charger is connected to the battery or the charge socket on the bike and the main power supply.

Note: The charging procedure is only possible when the temperature of the eBike battery pack is within the permissible charging temperature range.

Note: The drive unit is deactivated during the charging procedure.

The battery can be charged with or without the on-board computer. When charging without the on-board computer, the charging procedure can only be observed on the battery charge-control indicator.

If the on-board computer is connected, a corresponding message will be output on the display.

The on-board computer can be removed during the charging procedure, or it can also be attached after the charging procedure has begun.

The charging state is displayed by the battery charge-control indicator **A3** on the battery and by the bars on the on-board computer.

When charging the eBike battery on the bike, the battery for the on-board computer can also be charged.

During the charging procedure, the LEDs for charge-control indicator **A3** on the battery pack light up. Each continuously lit LED is equivalent to a charge capacity of approx. 20 %. The flashing LED indicates the charging of the next 20 %.

Once the battery is fully charged, the LEDs extinguish immediately and the on-board computer is switched off. The charging procedure is terminated. The charging state can be displayed for 3 seconds by pressing the On/Off button **A4**.

Disconnect the charger from the main power supply and the battery pack from the charger.

When disconnecting the battery pack from the charger, the battery pack is automatically switched off.

Note: If you have charged on the bike, carefully close the charge socket **C6** with the cover **C7** after the charging procedure so that no dirt or water can get in.

If the charger is not disconnected from the battery after charging, after a few hours the charger will switch itself back on, check the charging state of the battery and begin the charging procedure again if necessary.

Troubleshooting

On-board Computer Intuvia

Error Code Indicator

The components of the eBike system are continuously and automatically monitored. When an error is detected, the respective error code is indicated in text indicator **d**.

To return to the standard indicator, press any button on the on-board computer **3** or on the operating unit **10**.

Depending on the type of error, the drive unit is automatically shut off, if required. Continued travel without assistance from the drive unit is possible at any time. However, have the eBike checked before attempting new trips.



► **Troubleshooting actions may be performed by the owner except those explicitly noted as “Contact your Bosch eBike dealer”.**

Code	Cause	Corrective Action
410	One or more buttons of the on-board computer are blocked.	Check if any buttons are blocked, e.g., by dirt or debris. Clean the buttons, if required.
414	Operating unit connection problem	Have connections and contacts checked.
418	One or more buttons of the operating unit are blocked.	Check if any buttons are blocked, e.g., by dirt or debris. Clean the buttons, if required.
422	Drive unit connection problem	Have connections and contacts checked.
423	eBike battery pack connection problem	Have connections and contacts checked.
424	Communications error among the components	Have connections and contacts checked.
426	Internal time-out error	Restart the system. If the problem persists, contact your Bosch eBike dealer. In this error status, it is not possible to display or adjust the wheel circumference in the basic settings menu.
430	Internal battery pack of on-board computer empty	Charge on-board computer (in holder or via USB port).
440	Internal error in the drive unit	Restart the system. If the problem persists, contact your Bosch eBike dealer.
450	Internal software error	Restart the system. If the problem persists, contact your Bosch eBike dealer.
490	Internal error in the on-board computer	Have the on-board computer checked.
500	Internal error in the drive unit	Restart the system. If the problem persists, contact your Bosch eBike dealer.
502	Bike lighting error	Check the light and the associated wiring. Restart the system. If the problem persists, contact your Bosch eBike dealer. Do not ride in the dark without lights.
503	Error of the speed sensor	Restart the system. If the problem persists, contact your Bosch eBike dealer.
510	Internal sensor error	Restart the system. If the problem persists, contact your Bosch eBike dealer.
511	Internal error in the drive unit	Restart the system. If the problem persists, contact your Bosch eBike dealer.
530	Battery pack error	Switch off the eBike, remove the eBike battery pack and reinsert the eBike battery pack. Restart the system. If the problem persists, contact your Bosch eBike dealer.

Code	Cause	Corrective Action
531	Configuration error	Restart the system. If the problem persists, contact your Bosch eBike dealer.
540	Temperature error	The eBike is outside of the permissible temperature range. Switch off the eBike system and allow the drive unit to either cool down or heat up to the permissible temperature. Restart the system. If the problem persists, contact your Bosch eBike dealer.
550	An improper load was detected.	Remove the load. Restart the system. If the problem persists, contact your Bosch eBike dealer.
580	Software version error	Restart the system. If the problem persists, contact your Bosch eBike dealer.
591	Authentication error	Switch off the eBike system. Remove the battery pack and reinsert it. Restart the system. If the problem persists, contact your Bosch eBike dealer.
592	Incompatible component	Insert a compatible display. If the problem persists, contact your Bosch eBike dealer.
593	Configuration error	Restart the system. If the problem persists, contact your Bosch eBike dealer.
595, 596	Communication error	Check the wiring to the transmission and restart the system. If the problem persists, contact your Bosch eBike dealer.
602	Internal battery pack error while charging	Unplug the charger from the battery pack. Restart the eBike system. Plug the charger into the battery pack. If the problem persists, contact your Bosch eBike dealer.
602	Internal battery pack error	Restart the system. If the problem persists, contact your Bosch eBike dealer.
603	Internal battery pack error	Restart the system. If the problem persists, contact your Bosch eBike dealer.
605	Battery pack temperature error	The eBike is outside of the permissible temperature range. Switch off the eBike system and allow the drive unit to either cool down or heat up to the permissible temperature. Restart the system. If the problem persists, contact your Bosch eBike dealer.
605	Battery pack temperature error while charging	Unplug the charger from the battery pack. Allow the battery pack to cool. If the problem persists, contact your Bosch eBike dealer.
606	External battery pack error	Check the wiring. Restart the system. If the problem persists, contact your Bosch eBike dealer.
610	Battery pack voltage error	Restart the system. If the problem persists, contact your Bosch eBike dealer.
620	Charging error	Replace the charger. Contact your Bosch eBike dealer.
640	Internal battery pack error	Restart the system. If the problem persists, contact your Bosch eBike dealer.
655	Multiple battery pack errors	Switch off the eBike system. Remove the battery pack and reinsert it. Restart the system. If the problem persists, contact your Bosch eBike dealer.

Code	Cause	Corrective Action
656	Software version error	Contact your Bosch eBike dealer so that he can perform a software update.
7xx	Transmission error	Please observe the operating instructions provided by the transmission manufacturer.
No display	Internal error in the on-board computer	Restart your eBike system by switching it off and back on.

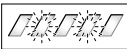
PowerPack

Cause	Corrective Action
 <p>Battery pack defective</p>	<p>Two LEDs of the battery pack flashing</p> <p>Contact an authorized bicycle dealer.</p>
 <p>Battery pack too warm or too cold</p>	<p>Three LEDs of the battery pack flashing</p> <p>Disconnect the battery from the charger until the charging temperature range has been reached. Do not connect the battery pack to the charger until it has reached the permissible charging temperature.</p>
 <p>The charger is not charging.</p> <p>No charging procedure possible (no indication on the battery pack)</p>	<p>No LED flashes (one or more LEDs light up continuously depending on the charging state of the eBike battery pack).</p> <p>Contact an authorized bicycle dealer.</p>
Plug not inserted correctly	Check all plug connections
Contacts of battery pack dirty	Carefully clean the contacts on the battery pack.
Socket outlet, cable or charger defective	Check household voltage; have charger checked through bicycle dealer
Battery pack defective	Contact an authorized bicycle dealer.

Battery Recycling Program

General Warnings

Disposal



The drive unit, on-board computer (incl. the operating unit), battery pack, speed sensor, accessories and packaging should be sorted for environmentally-friendly recycling.

Do not dispose of eBikes and their components with the household waste!



You may recycle your Bosch battery pack by calling 1-800-822-8837.

EC Declaration of conformity 2018 CE

The manufacturer: Koninklijke Gazelle N.V.
Wilhelminaweg 8
6951 BP Dieren, Nederland
+31(0)900-7070707

Hereby declares that the following products:

Product description: Impulse
Model description: Orange C7 HMI, Orange C8 HMI, Arroyo C7 HM, Arroyo C7 HMI, Arroyo C7+ HMI, Arroyo C7+ HMI5

Product description: Bosch
Model description: CityZen C8 HMB, Cityzen C8+ HMB, Cityzen T10 HMB, Cityzen Speed HMB, Cityzen Speed 380 HMB, Orange C7 HMB, Orange C7 HMB Exclusive, Orange C7+ HMB, Orange C7+ HMB LTD, Orange C7+ HMB Demo, Orange C8 HMB, Orange CX HMB, Orange C330 HMB, Arroyo C7 HMB, Arroyo C7+ HMB, Arroyo C7+ HMB ZLTD, Arroyo C7+ HMB ZEG, Arroyo C7+ HMB Spezial, Arroyo C8 HMB R8H, Ultimate C8 HMB, Ultimate T9 HMB, Ultimate T10 HMB, Chamonix T10 HMB, Deauville C8 HMB, Valencia C7 HMB, Mallorca C7 HMB, Grenoble C7 HMB, Grenoble C7+ HMB, Miss Grace C7 HMB, Miss Grace C7 HMB R7H, Miss Grace C7+ HMB R7H, Gazelle NL C7 HMB, Heavy Duty NL C7 HMB, Cadiz C7 HMB, Vento C7 HMB, Luzern C7 HMB, Ultimate CX HMB

Product description: Panasonic
Model description: Heavy Duty NL HFP, RP Duty NL HFP, Orange C7 HFP, Orange C7+ HFP, Orange C8 HFP Demo, Arroyo C7 HFP, Arroyo C7+ HFP, Arroyo C7 HFP R7H, Chamonix C7 HFP, Grenoble C7+ HFP, Puur_NL C7+ HFP, Balance C7 HFP

Product description: Shimano Steps
Model description: Orange C7 HMS, Orange C7 HMS Demo, Orange C8 HMS, Orange C330 HMS, Arroyo C7 HMS, Arroyo C7+ HMS, Arroyo C8 HMS, Arroyo C8 HMS, Chamonix C7 HMS, Avenue C8 HMS

Year of manufacture: 2017/20178

Satisfies all the relevant requirements of the EC Declaration (2006/42/EC).

The machine also satisfies all requirements of the Electromagnetic Compatibility Directive (2014/30/EU) and of the Machinery Directive (2006/42/EU).

The following harmonised standards apply:

NEN-EN-ISO 15194: 2009 Cycles – Electrically power-assisted cycles – EPAC bicycles;
ISO 4210-2: 2015: Cycles – Safety requirements for bicycles – Part 2: Requirements for city and trekking, young adult, mountain bikes and racing bicycles.

Maarten Pelgrim
Innovation Manager



Koninklijke Gazelle N.V.
Wilhelminaweg 8, 6951 BP Dieren, The Netherlands

ROYAL DUTCH Gazelle N.V.

Wilhelminaweg 8
6951 BP Dieren
The Netherlands

GAZ_BAL_USA_18.1

Enjoy the Ride | **ROYAL DUTCH**
Gazelle

