



Electric Pasta and Noodle Maker

USER CARE AND INSTRUCTION MANUAL

Thank you for purchasing the **RICARDO** electric pasta and noodle maker. Before using this product, please read the user care and instruction manual carefully.



IMPORTANT SAFEGUARDS

.....

When using electrical appliances, basic safety precautions should always be followed to prevent fire, electric shock, serious personal injury and/or property damage, including the following.

READ ALL INSTRUCTIONS CAREFULLY BEFORE FIRST USE

- ::: This appliance should not be used by children. Keep appliance and its cord out of the reach of children and pets. Close adult supervision is necessary when any appliance is used near children.
- ::: Always place the appliance on a flat, stable and heat-resistant surface. Do not use the appliance on temperature sensitive surfaces.
- ::: Do not place the appliance on or near a hot gas or electric burner or in a heated oven or microwave oven.
- ::: Keep away from curtains, wall coverings, clothing, dish towels or other flammable materials. Ensure there is sufficient space surrounding the appliance.
- ::: This appliance is intended for household use only. Do not use outdoors.
- ::: Do not use this appliance for any other purpose than it's intended one. Do not use any accessories that are not recommended by the manufacturer or included with the appliance.
- ::: Do not leave the appliance unattended. Always unplug the appliance from the electrical outlet when not in use.
- ::: Always make sure the lid of the mixing bowl is securely closed during use. Do not attempt to override the locking mechanism of the lid.
- ::: Ensure the opening of the shaping disc is not blocked before each use.
- ::: Do not put fingers or any other object inside the appliance while it is operating. Avoid all contact with moving parts.
- ::: Always make sure the motor and mixing blade have stopped working before assembling, moving, disassembling, or cleaning the appliance.
- ::: Let the appliance cool for 30 minutes after each cycle. Do not operate the appliance for more than two consecutive cycles. The appliance could overheat and shut down.
- ::: Do not put anything on the appliance while in use.
- ::: Always clean and dry thoroughly each part between all cycles of pasta making. Parts that are not cleaned thoroughly can affect the consistency of the pasta and the extrusion process may fail.
- ::: Do not let the power cord hang (over the edge of a table or counter) to avoid tripping. Do not let the power cord touch hot surfaces.
- ::: Do not operate the appliance with a damaged cord or plug, after the appliance malfunctions or has been damaged in any manner. Do not attempt to repair this product yourself. If there is a problem, please call 1-866-226-9222.
- ::: To protect against electrical shock, never immerse the power cord, the plug or the machine in water or other liquid.

- ::: Do not plug or unplug the product into/from the electrical outlet with wet hands.
- ::: Use the provided plug only.
- ::: Connect the power plug to an easily accessible outlet so that the appliance can be unplugged immediately in the event of an emergency.
- ::: The cord for this appliance should be plugged into a 120 V AC electrical wall outlet.
- ::: Always turn off and unplug appliance from the electrical outlet before cleaning or when not in use. To unplug, grasp the plug and pull it from the electrical outlet. Never pull the cord. Make sure the motor and mixing blade have stopped working. Unplug the appliance and allow all parts to cool down completely before handling or attempting to clean.
- ::: The device must not be operated via an external timer or remote control.

SAVE THESE INSTRUCTIONS - FOR HOUSEHOLD USE ONLY

NOTES ON THE PLUG

.....

As a safety feature, the appliance is equipped with a grounded plug, which will only fit into a three-prong outlet. Do not alter the plug. Do not attempt to defeat this safety feature. Improper connection of the grounding conductor may result in the risk of electric shock. Contact a qualified electrician if there is doubt as to whether the outlet is properly grounded.

NOTES ON THE CORD

.....

A short power-supply cord is provided to reduce risks resulting from becoming entangled in or tripping over a longer cord. Longer extension cords are available and may be used if care is exercised in their use.

IF AN EXTENSION CORD IS USED:

- ::: The marked electrical rating of the extension cord should be at least as great as the electrical rating of the appliance.
- ::: If the appliance is of the grounded type, the extension cord should be a grounding type 3-wire cord.
- ::: The longer cord should be arranged so that it will not drape over a countertop or tabletop where it can be pulled on.

ELECTRIC POWER

.....

If the electrical circuit is overloaded with other appliances, the appliance may not operate properly. It should be plugged into a separate electrical circuit.

TECHNICAL DATA

.....

Main voltage: 120 V / Frequency: 60 Hz / Power consumption: 240 watts

PARTS IDENTIFICATION

Product may vary slightly from diagram.

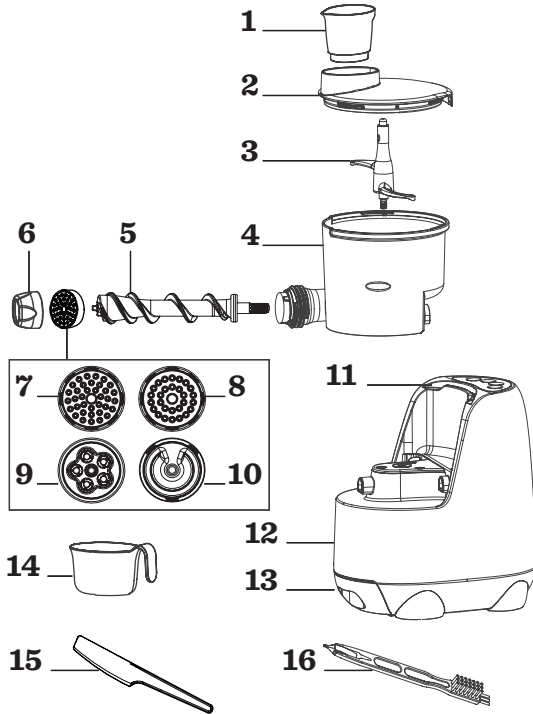

1. Liquid measuring cup (ml)
2. Lid
3. Mixing blade
4. Mixing bowl
5. Auger
6. Disc holder
7. Shaping disc for spaghetti
8. Shaping disc for spaghettoni (thick spaghetti)
9. Shaping disc for penne
10. Shaping disc for lasagna
11. Control panel
12. Motor base
13. Built-in storage drawer for shaping discs
14. Flour measuring cup
15. Knife
16. Cleaning brush

CONTROL PANEL

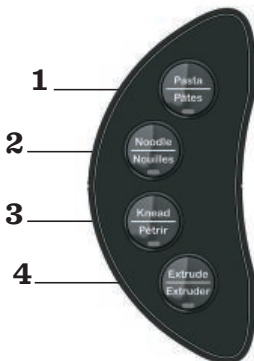

AUTOMATIC MODE

1. Pasta: automatically mixes, kneads and extrudes pasta
2. Noodle: automatically mixes, kneads and extrudes noodles

MANUAL MODE

3. Knead
4. Extrude

BEFORE FIRST USE

.....

- 1- Read all instructions and important safeguards.
- 2- Remove all packaging materials and ensure that all items have been received in good condition.
- 3- Tear up all plastic bags as they can pose a risk to children.
- 4- Do not plug the appliance into an electrical outlet before it is ready to be used.
- 5- Peel off protective film on control panel.
- 6- Wipe the appliance with a soft damp cloth. Dry thoroughly. NEVER IMMERSE the base, the power cord, or the power plug in water or any liquid.
- 7- Wash the shaping discs and all detachable parts of the appliance in hot soapy water. The shaping discs and all detachable parts of the appliance are dishwasher safe.. When cleaning in a dishwasher, ensure to select the program with a maximum temperature of 60 °C (140 °F). When washing by hand, make sure to dry thoroughly all separate parts.

NOTE

::: Do not use abrasive cleaners or scouring pads or any other object that could scratch or damage.

ASSEMBLING

.....

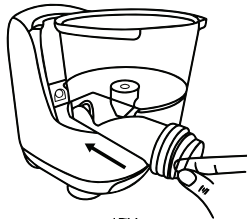

- 1- Make sure the appliance is unplugged during the assembly. Slide the mixing bowl onto the motor base. Make sure to align the three recesses on the bowl with the notches on the base.

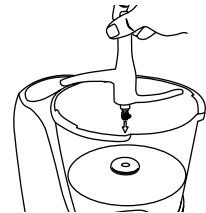

- 2- Place the mixing blade onto the center piece of the mixing bowl. Make sure the mixing blade is well pressed down.

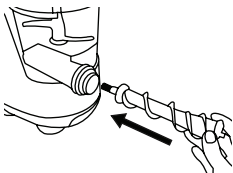

- 3- Insert the auger into the opening on the side of the mixing bowl. Slide the smallest extremity inside first and make sure the auger is well pushed in.

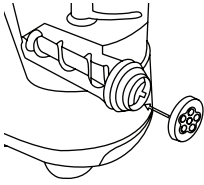

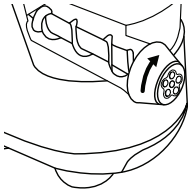

- 4- Attach the desired shaping disc onto the disc support, where the auger has been inserted. The flat side of the disc should be on the outside. The disc must snap on to the fixing point.

NOTE: The appliance comes with the lasagna shaping disc already installed.

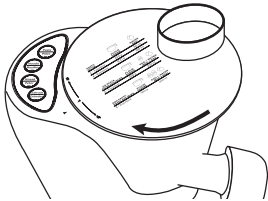

- 5- Screw the disc holder onto the disc support, turning it clockwise. Do not overtighten. **NOTE:** Always install the shaping disc before the shaping disc holder. Never install the shaping disc inside the disc holder to install them together in the base.



- 6- Place the lid on the mixing bowl by aligning the arrow on the base with the arrow on the lid. Turn the lid to the  symbol to lock it in place. You should feel and hear it click into place.

NOTE: this appliance is equipped with a safety device that will prevent it from working if the lid is not securely in place.

PREPARING INGREDIENTS

.....

Before turning on the pasta machine, prepare both the dry and liquid ingredients in advance.

- 1- Use the measuring cup included with the appliance to measure 1 cup of flour. Remove excess flour with the provided knife. One full cup equals approximately 250 g. Do not shake or tap the cup to remove excess flour to avoid altering the quantity of flour.

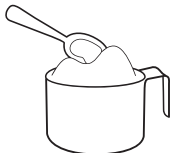

FILL WITH FLOUR



LEVEL FLOUR



250 g OF FLOUR

For best results, use a kitchen scale to measure the ingredients. One full cup of flour equals approximately 250 g, which will yield 2-3 portions of pasta. Double the quantity of flour to 500 g to yield 4-6 portions of pasta. NEVER exceed the maximum quantity of 500 g of flour.

NOTE:

::: The flour measuring cup provided with the appliance is not a standard measuring cup and should not be used as such.

::: Some flours are not recommended for pasta making. Please refer to the specially tested recipes for the **RICARDO** pasta machine at the end of this manual.

2- Use the measuring cup for liquid provided with the appliance to measure the volume of liquid ingredients in ml. When measuring liquids, always place the measuring cup on a flat surface. For recipes requiring eggs, always beat the egg with water or other liquid ingredient.



To obtain the correct flour-liquid measurement, consult the basic recipes printed on the lid of the appliance or the recipes at the end of this manual.

USING THE ELECTRIC PASTA AND NOODLE MAKER

.....

During first use of the appliance, smoke and/or a slight odour may occur from the appliance because of the initial warming process of the materials. This is normal and will quickly disappear. It will not recur after appliance has been used a few more times.

Prepare both the dry and liquid ingredients in advance.

- 1- Place the appliance on a flat, dry, stable and heat-resistant surface.
- 2- Consult the "ASSEMBLING" section to assemble the appliance with the shaping disc for the type of pasta or noodle desired.
- 3- Plug the power cord into a standard 120 V AC wall outlet. The appliance will beep and indicator lights on the control panel will light up.
- 4- Turn the lid counterclockwise to the  symbol and lift it up. During the opening of the lid, the indicator lights on the control panel will shut off.
- 5- Add the flour and other dry ingredients into the mixing bowl using the flour measuring cup. Refer to the "PREPARING INGREDIENTS" section. NEVER exceed the maximum quantity of 500 g of flour.
- 6- Replace the lid on the mixing bowl by aligning the arrow on the base with the arrow on the lid. Turn clockwise to the  symbol to lock the lid in place. You should feel and hear it click into place. Once the lid is securely in place, a beep will be heard and the indicator lights on the control panel will light up. The appliance will not turn on if the lid is not closed securely in place.
- 7- Place a plate or container that has been lightly dusted with flour under the shaping disc opening to collect the pasta.

- 8- To select the automatic option, press the «Pasta» or «Noodle» button depending on the recipe.
- 9- After the mixing blade begins turning, add the liquid.
Refer to the "PREPARING INGREDIENTS" section.

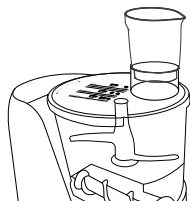

If only water or vegetable juice is being used, place the liquid measuring cup directly on the lid, in its allotted space. The liquid will start to drip slowly into the mixing bowl.

OR

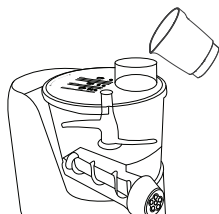

If the liquid ingredients are a mixture of egg and water or vegetable juice: beat the eggs in a separate bowl, then pour into the liquid measuring cup and add water or vegetable juices to the egg mixture. Slowly and consistently pour the mixture into the opening on the lid.

NOTE: Make sure the mixing blade has started mixing the flour before adding the liquid ingredients to avoid the formation of lumps.

10- After approximately five minutes, the appliance will start extruding pasta.

11- As the pasta comes out, cut the pasta to the desired length using the knife included.

NOTE:

::: As the pasta is extruded from the machine, sprinkle flour over the pasta to prevent them from sticking together.

::: The first centimetres of pasta coming out of the shaping disc can be slightly deformed, dry or not in the intended final form. Using the knife included, cut off the first centimetres of pasta. Roll into a ball, separate it into pieces, open the lid and put back into the mixing bowl.

The appliance has an internal memory that allows for the lid to be open for about 30 seconds without disrupting the cycle. Once the lid is closed again, the cycle will continue from where it was stopped. **DO NOT** press the "Pasta" or "Noodle" buttons before opening the lid.

::: To cut the pasta, always cut from top to bottom motion with the knife.

12- Once the mixing bowl is empty, the appliance will beep four consecutive times.

NOTE: If there is some dough left in the mixing bowl, press the «Extrude» button.

The machine will stop automatically when there is less or no dough left or you can press the “Extrude” button again to stop the function. If the quantity of dough left is important, it probably means the ratio flour/liquid was incorrect. Refer to the “TROUBLESHOOTING” section.

13- Unplug the appliance. **NOTE:** Let the appliance rest 30 minutes between each cycle of use.

DO NOT use the appliance for more than two continuous cycles without rest, the appliance could overheat.

USEFUL TIPS

.....

AUTOMATIC MODE AND MANUAL MODE

::: The “Pasta” and “Noodle” buttons on the control panel allow to launch the automatic mode.

The appliance will mix, knead and extrude the pasta or noodles automatically. These two modes have been designed for the successful completion of the **RICARDO** recipes included with this manual.

::: The manual mode will let you experiment and try other recipes. Prepare your ingredients as indicated in the “PREPARING INGREDIENTS” section, then press the “Knead” button to launch the manual program. The “Knead” program is six minutes long but can be stopped at any time by pressing the Knead button a second time. When the consistency of the dough is satisfactory, press the “Extrude” button. The appliance will start extruding pasta.

The appliance will stop automatically extruding when it cannot detect any dough remaining in the mixing bowl for 30 seconds.

SHAPING DISCS

4 shaping discs are included with the appliance:



Shaping disc for spaghetti



Shaping disc for spaghettoni (thick spaghetti)



Shaping disc for penne



Shaping disc for lasagna

PENNE

::: The shaping disc for penne pasta is made up of two parts.

When cleaning, use the back end of the cleaning brush to separate into two parts.

::: To ensure the penne pasta is the proper shape and to avoid the pasta clumping together when cutting, the dough should not be too wet. Use a kitchen scale to precisely measure the flour and the ratio flour/liquid must be correct.

Cut the penne pasta with the knife included as close as possible to the disc.

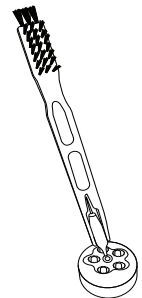

LASAGNA

::: The first 20 centimetres of lasagna that comes out may be drier and deformed: cut off this section, roll into a ball, separate it into pieces, open the lid of the machine, put back into the mixing bowl and replace the lid. The appliance has an internal memory that allows for the lid to be open for about 30 seconds without disrupting the cycle. When the lid is closed, the cycle restart where it was stopped.

::: When the pasta is extruded, cut to the desired length, and put on a flat surface that has been dusted with flour.

::: When making lasagna, put the pasta directly in the cooking dish. Precooking is not needed.

FETTUCCINE AND PAPPARDELLE

::: To make pappardelle or fettuccine, use the lasagna shaping disc then roll a sheet of lasagna pasta, using a knife cut into ribbons width of 2.5 cm for the pappardelle and 0.6 cm for the fettuccine.

DOUGH CONSISTENCY

For best results, the dough should not be too dry nor too wet. The correct consistency should be crumbly. Read the basic recipes on the lid of the mixing bowl or the **RICARDO** recipes at the end of this manual for the correct ration flour/liquid.



Dough is too dry



Dough has the correct consistency



Dough is too wet

If the dough is too dry, add 5 to 10 ml of liquid.

If the dough is too wet, remove the lid and break up the clumps. Add 2 tbsp of flour and close the lid. The appliance has an internal memory that allows for the lid to be open for about 30 seconds and keep the settings in place. When the lid is closed, the cycle restart where it was stopped.

If the cycle does not restart automatically, push the “Knead” button to go into manual mode.

When the consistency is correct, push the “Knead” button again to stop the manual mode.

Push the “Extrude” button to start extruding pasta. The appliance will stop automatically when it cannot detect any more dough to extrude after 30 seconds.

COOKING PASTA

Fresh pasta can be cooked immediately after extrusion. Bring a large pot of salted water to a boil. Estimate a litre of water for 100 g of pasta and a tablespoon of salt for 5 litres of water. Once the salted water has reached a boil, gently drop the fresh pasta into the pot. Gently stir the pasta to prevent from sticking. Fresh pasta is better when cooked AL DENTE. The cooking time depends on the shape and the thickness of the pasta but in general 2 to 3 minutes in salted boiling water is enough. Penne pasta will take longer to cook, 4 to 5 minutes. If pasta is not cooked, continue to check every 30 seconds until the pasta is cooked. To verify if the pasta is cooked, take it out of the water with a utensil and taste it. When cooking is complete, strain immediately to stop the cooking process.

STORING PASTA

If the pasta will not be eaten immediately, lightly dust with flour and separate them to ensure they do not stick together. Let them air dry for 30 to 45 minutes. Separate into portions and put them into an airtight container. Fresh pasta can be kept in the refrigerator for two days. Fresh pasta can also be frozen into airtight containers for up to four weeks in the freezer. To cook frozen pasta, put them directly into boiling water. Do not thaw the pasta at room temperature or in the refrigerator. The humidity in the pasta will cause them to stick together. In the cooking pot, make sure to stir the pasta to avoid clumping in the water.

CLEANING

.....

IMPORTANT: Unplug the appliance and allow all parts to cool down completely before handling or attempting to clean.

::: DO NOT IMMERSE motor body, power cord or plug in water or any other liquid and always protect these parts against humidity. At all times, the base of the appliance must be kept dry.

::: Clean the appliance after each use otherwise the appliance will not work properly.

NOTE: Do not use abrasive cleaners or scouring pads or any other object that can scratch the surface

1- Disassemble all the parts. Refer to the "ASSEMBLING" section in reverse order.

2- Wipe base with a damp cloth and dry thoroughly.

3- Wash the shaping discs and all detachable parts of the appliance in hot soapy water.

The shaping discs and all detachable parts of the appliance are dishwasher safe.

When cleaning in a dishwasher, ensure to select the program with a maximum temperature of 60 °C (140 °F). When washing by hand, make sure to dry thoroughly all separate parts.

4- Use the back end of the cleaning brush to remove pieces of dough from the shaping disc.

NOTE: For easy cleanup, allow the dough to dry for several hours before attempting to clean the disc.

5- Reassemble the appliance to store away. Refer to the "ASSEMBLING" section.

STORAGE

Ensure all pieces are clean and dry before storing. Store appliance in a dry, clean place. Never wrap the cord tightly as this could place undue stress on the cord where it connects to the appliance, causing it to fray and break. Keep it loosely coiled.

TROUBLESHOOTING GUIDE

PROBLEM	SOLUTION
The control panel does not light up when the appliance is plugged.	<p>-The control panel will light up only if the lid is locked securely.</p> <p>Make sure the lid is closed and locked properly. If it is the case, make sure the power cord is plugged and that the outlet is working.</p>
A small quantity of liquid is leaking from the appliance.	<p>-All liquids must be added after the “Pasta” or “Noodle” buttons have been pushed</p> <p>Consult the “USING THE ELECTRIC PASTA AND NOODLE MAKER” section in this manual.</p>
No pasta coming out of the appliance.	<p>-The shaping disc is blocked.</p> <p>Stop the program and unplug the appliance. Unscrew the shaping disc support and remove the disc. Clean and dry thoroughly the disc before putting it back in the appliance. Screw the shaping disc support and plug the appliance. Launch the “Extrude” program.</p> <p>-The flour/liquid ratio is incorrect.</p> <p>Study the consistency of the dough. If the dough is too dry or too wet, consult the “DOUGH CONSISTENCY” section of this manual. Still if no pasta is coming out, stop the program and unplug the appliance, discard the dough. Clean the appliance. Dry each part thoroughly. Start your recipe again by measuring the ingredients precisely as indicated in the chosen recipe. Restart the pasta-making process by following the instructions in this manual.</p>

PROBLEM	SOLUTION
Important quantity of dough left over in the tank.	<p>-The flour/liquid ratio is incorrect.</p> <p>Follow the instructions in the “DOUGH CONSISTENCY” section of this manual. To measure the ingredients with more precision, use a kitchen scale. It is also possible that the parts of the appliance have not been cleaned correctly or are still humid. Always clean and dry the parts of the appliance thoroughly.</p>
The appliance has stopped during the pasta-making process.	<p>-The appliance has overheated because of a long continuous use.</p> <p>Unplug the appliance and discard the dough left in the tank. Let the appliance rest for 30 minutes between each cycle. DO NOT use the appliance for more than two continuous cycles without rest because the appliance will overheat and shut down.</p>

2-YEAR LIMITED WARRANTY (Applies only in Canada)

.....

This warranty covers any defects in materials and workmanship for a period of two (2) years from the date of the original purchase. Please retain your original receipt as a proof of the purchase date. Any complaints must be registered within the warranty period. The product will be repaired, replaced (parts or entire appliance) or refunded at our sole discretion. Shipping charges may apply.

This warranty does not cover normal wear of parts or damage resulting from any of the following: negligent use or misuse of the product including failure to clean the product regularly, use for commercial purposes, accident, use on improper voltage or current, use contrary to the operating instructions, disassembly, repair or alteration by anyone other than a **RICARDO** authorized service agent.

Please do not return this product to the store. For assistance, please contact 1-866-226-9222.

If you have any questions regarding this product, please contact our customer service:

::: by e-mail: kitchenproducts@ricardocuisine.com

::: by phone: 1-866-226-9222

The pasta recipes in this manual have been tested exclusively for the **RICARDO** electric pasta and noodle maker. If other recipes are used, the flour and the liquid/egg proportions will have to be readjusted to the quantities of flour and water indicated for the **RICARDO** pasta maker. The appliance will not work properly if the quantities of the new recipe have not been adapted correctly.

- 1- Install the shaping disc for the desired pasta.
- 2- Plug the appliance.
- 3- Open the lid and add the dry ingredients in the mixing bowl. Close the lid.
- 4- Press the “Pasta” or “Noodle” button on the control panel.
- 5- Slowly and consistently pour the liquid into the opening on the lid.
- 6- After approximately five minutes, the appliance will start extruding pasta.

For the detailed steps to follow, please refer to the “USING THE ELECTRIC PASTA AND NOODLE MAKER” section.

PASTA RECIPES	SHAPING DISCS TO USE	SERVINGS	DRY INGREDIENTS	CONTROL PANEL FUNCTION	LIQUID INGREDIENTS
CLASSIC PASTA	As desired: -Spaghetti -Spaghettoni (thick spaghetti)	2 to 3	250 g of unbleached all-purpose flour	Pasta	90 ml of water or carrot, beet or spinach juice
	-Penne -Lasagna	4 to 6	500 g of unbleached all-purpose flour	Pasta	180 ml of water or carrot, beet or spinach juice
WHOLE-WHEAT PASTA	As desired: -Spaghetti -Spaghettoni (thick spaghetti)	2 to 3	250 g of whole-wheat flour	Pasta	90 ml of water or carrot, beet or spinach juice
	-Penne -Lasagna	4 to 6	500 g of whole-wheat flour	Pasta	180 ml of water or carrot, beet or spinach juice

PASTA RECIPES	SHAPING DISCS TO USE	SERVINGS	DRY INGREDIENTS	CONTROL PANEL FUNCTION	LIQUID INGREDIENTS
EGG PASTA	As desired: -Spaghetti -Spaghettoni (thick spaghetti) -Penne -Lasagna	2 to 3	250 g of unbleached all-purpose flour NOTE: If desired, add: -1 tsp finely grated lemon zest -½ tsp freshly ground black pepper	Pasta	100 ml = 1 egg top up with enough water or carrot, beet or spinach juice to reach 100 ml
		4 to 6	500 g of unbleached all-purpose flour NOTE: If desired, add: -2 tsp finely grated lemon zest -1 tsp freshly ground black pepper	Pasta	200 ml = 2 eggs top up with enough water or carrot, beet or spinach juice to reach 200 ml
WHEAT SEMOLINA PASTA	As desired: -Spaghetti -Spaghettoni (thick spaghetti) -Penne -Lasagna	2 to 3	250 g * of fine durum wheat semolina NOTE: If desired, add: -1 tsp finely grated lemon zest -½ tsp freshly ground black pepper	Pasta	100 ml = 1 egg top up with enough water or carrot, beet or spinach juice to reach 100 ml
		4 to 6	500 g * of fine durum wheat semolina NOTE: If desired, add: -2 tsp finely grated lemon zest -1 tsp freshly ground black pepper	Pasta	200 ml = 2 eggs top up with enough water or carrot, beet or spinach juice to reach 200 ml
WHOLE WHEAT EGG PASTA	As desired: -Spaghetti -Spaghettoni (thick spaghetti) -Penne -Lasagna	2 to 3	250 g of whole-wheat flour	Pasta	100 ml = 1 egg top up with enough water to reach 100 ml
		4 to 6	500 g of whole-wheat flour	Pasta	200 ml = 2 eggs top up with enough water to reach 200 ml

PASTA RECIPES	SHAPING DISCS TO USE	SERVINGS	DRY INGREDIENTS	CONTROL PANEL FUNCTION	LIQUID INGREDIENTS
RAMEN NOODLES	-Spaghettoni (thick spaghetti)	2 to 3	250 g of unbleached all-purpose flour	Noodle	Dissolve 2.5 ml of baking soda and 2.5 ml of salt in 90 ml of warm water
		4 to 6	500 g of unbleached all-purpose flour	Noodle	Dissolve 5 ml of baking soda and 5 ml of salt in 180 ml of warm water
SOBA NOODLES	-Spaghettoni (thick spaghetti)	2 to 3	110 g * of unbleached all-purpose flour + 140 g * of buckwheat flour	Noodle	100 ml of water
		4 to 6	220 g * of unbleached all-purpose flour + 280 g * of buckwheat flour	Noodle	200 ml of water
GLUTEN-FREE PASTA	As desired: -Spaghetti -Spaghettoni (thick spaghetti) -Penne -Lasagna	2 to 3	230 g * of Gluten-Free all-purpose flour NOTE: Select all-purpose gluten-free flour that has a high percentage of flours and a low percentage of starches.	Pasta	90 ml of water
COCOA PASTA	As desired: -Spaghetti -Spaghettoni (thick spaghetti) -Penne -Lasagna	2 to 3	240 g * of unbleached all-purpose flour + 10 g * of cocoa powder, sifted	Pasta	90 ml of water
		4 to 6	480 g * of unbleached all-purpose flour + 20 g * of cocoa powder, sifted	Pasta	180 ml of water

*For best results, weigh dry ingredients using a kitchen scale.

