



# BPD Designs

GUARD CATALOG



# CUSTOMIZE YOUR DESIGN

We can customize designs with your fabric choices, team logos, custom sublimation and even rhinestones!

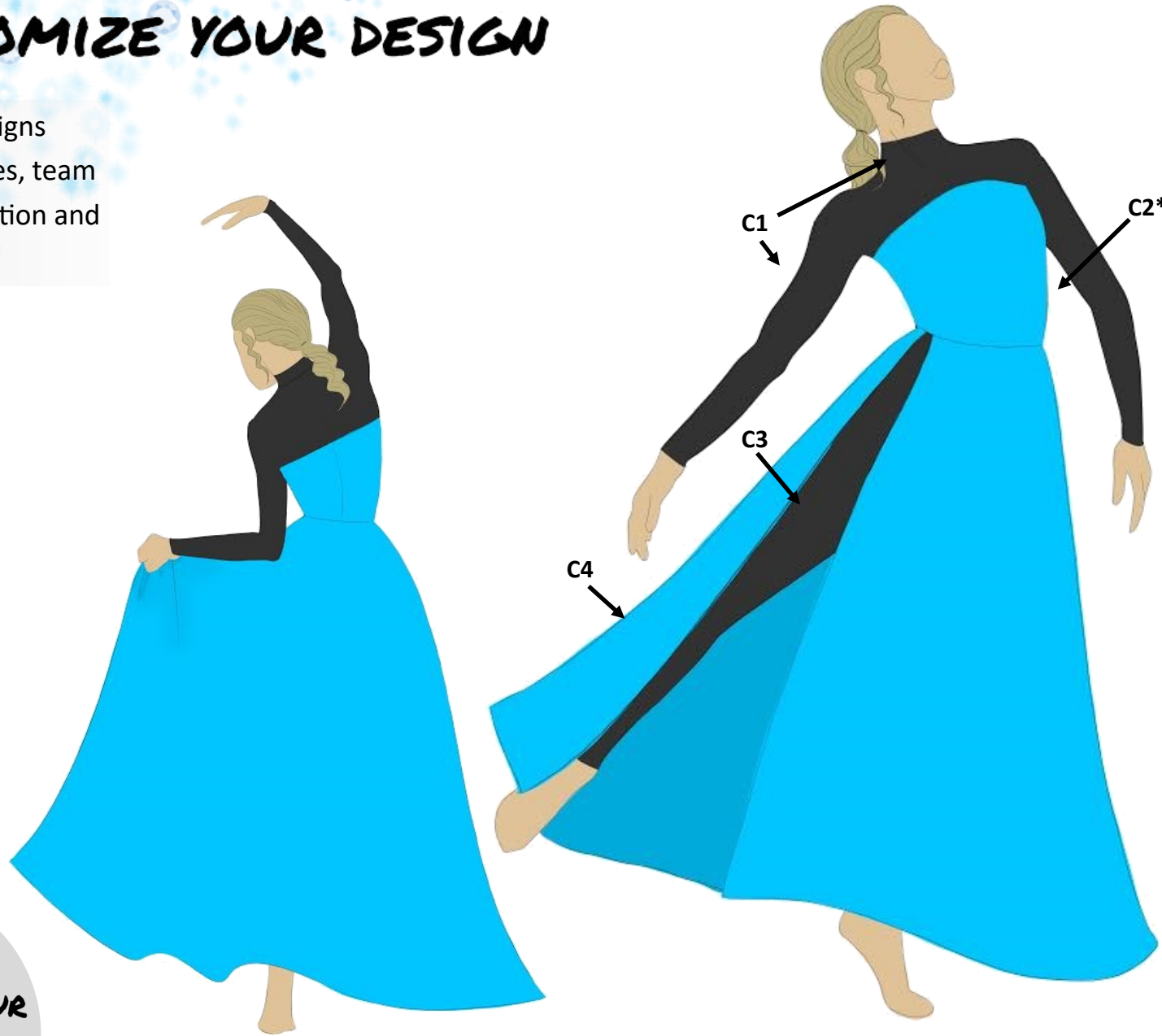

**ASK ABOUT OUR  
COORDINATING  
BOY STYLES**

99330 Dress with attached unitard. 3/4 circle skirt with a side slit.

\*Color code also available with sequin.

CAN CUSTOMIZE  
FOR TEAM LOOKS  
OR SHOW LOOKS



A

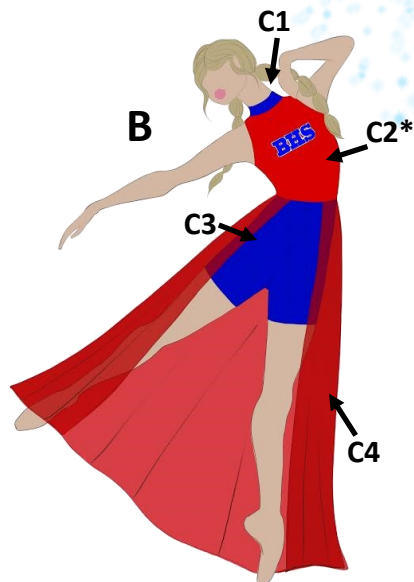

B



C



D

A.) 89324SH Zipback Biketard with half skirt and short attached. Shown in Black Fine Knit.

B.) 89324SH Zipback Biketard with half skirt and short attached. Shown in custom colors.

C.) 89324LEG Zipback Unitard with half skirt and legging attached.

D.) 89324SH Zipback Biketard with half skirt and short attached.

\*Color code also available with sublimation or sequin. For custom options on this costume contact us.

# DRESSES

STOCK DESIGN CHOSE YOUR FABRICS



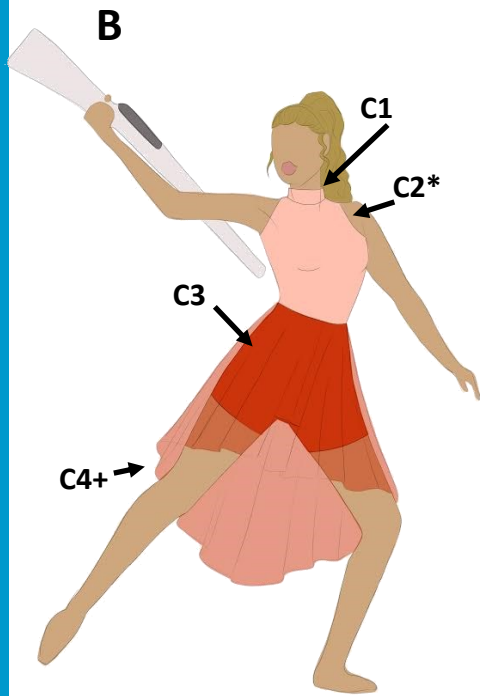

**A.) 99323BR** Mock neck high low dress with attached brief keyhole back with a high low mesh skirt. Shown in: Merlot matte top, D. Rose LG lace overlay, D. Rose brief and D. Rose mesh skirt.

**B.) 99323SH** Mock neck high low dress with attached biketard keyhole back with a high low mesh skirt.

**C.) 99323LEG** Mock neck high low dress with attached legging keyhole back with a high low mesh skirt.

\*Color code available with sequin. +Color code not available in sequin or mystique





**99328SH** Scoop neck tank dress with attached biketard and fly away skirt. Shown in: Gunmetal Zsa Zsa top, Steel matte trim and short and Black mesh skirt.



**A.) 99324BR** V pinch front cami dress with cross back straps, attached brief and mesh skirt. Shown in: Navy Zsa Zsa top, Navy matte straps and brief, and Navy mesh skirt

**B.) 99324SH** V pinch front cami dress with cross back straps, attached short and mesh skirt

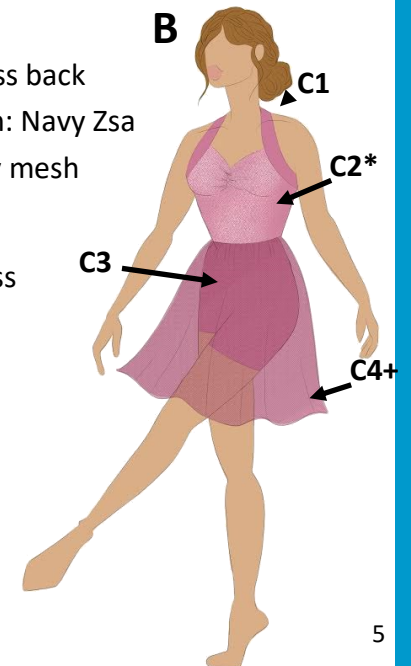

\*Color code also available with sequin. +Color code available in mesh or fine knit.



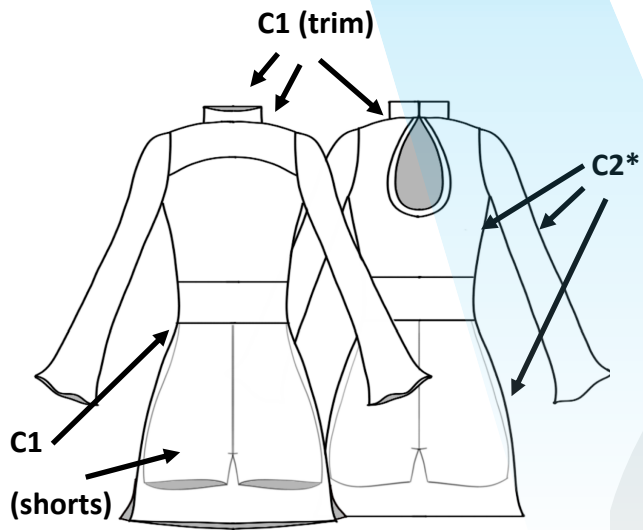

99331 Mock neck bell sleeve dress. Attached biketard and side slit skirt.

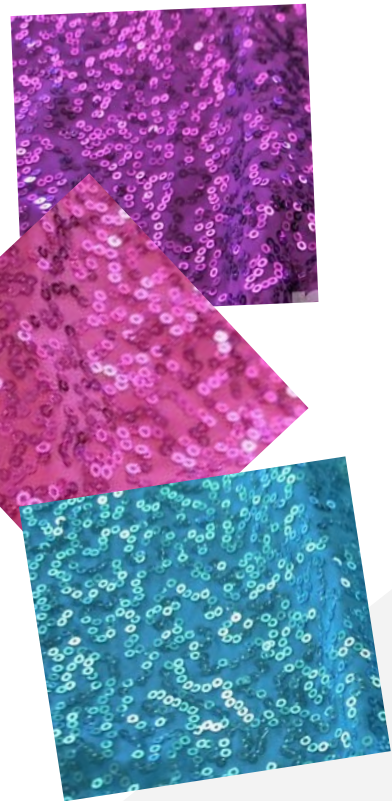

Fabric list on pages 36 and 37.

\*Color code available with sequin.





# CUSTOMIZE YOUR DESIGN

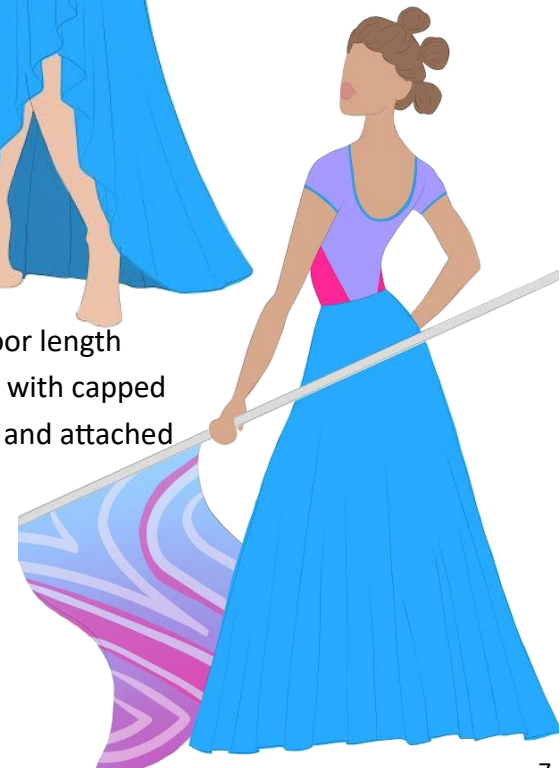
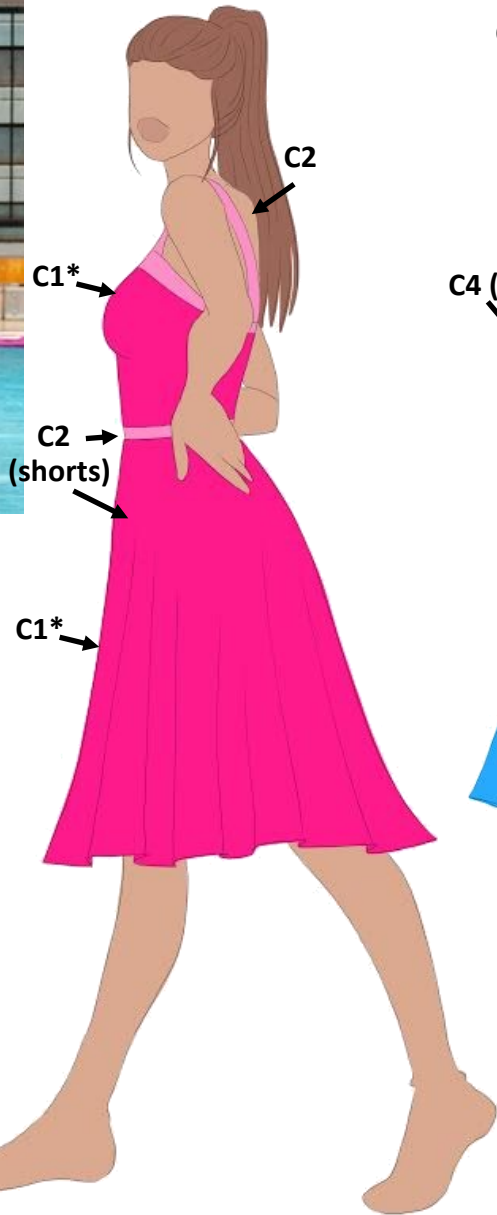

**99332** Sweetheart dress hitting right below the knee with attached short.

**99333** Floor length petal skirt with capped shoulders and attached short.

\*Color code also available with sequin +Color code not available with sequin or mystique



**ADD  
RHINESTONES**

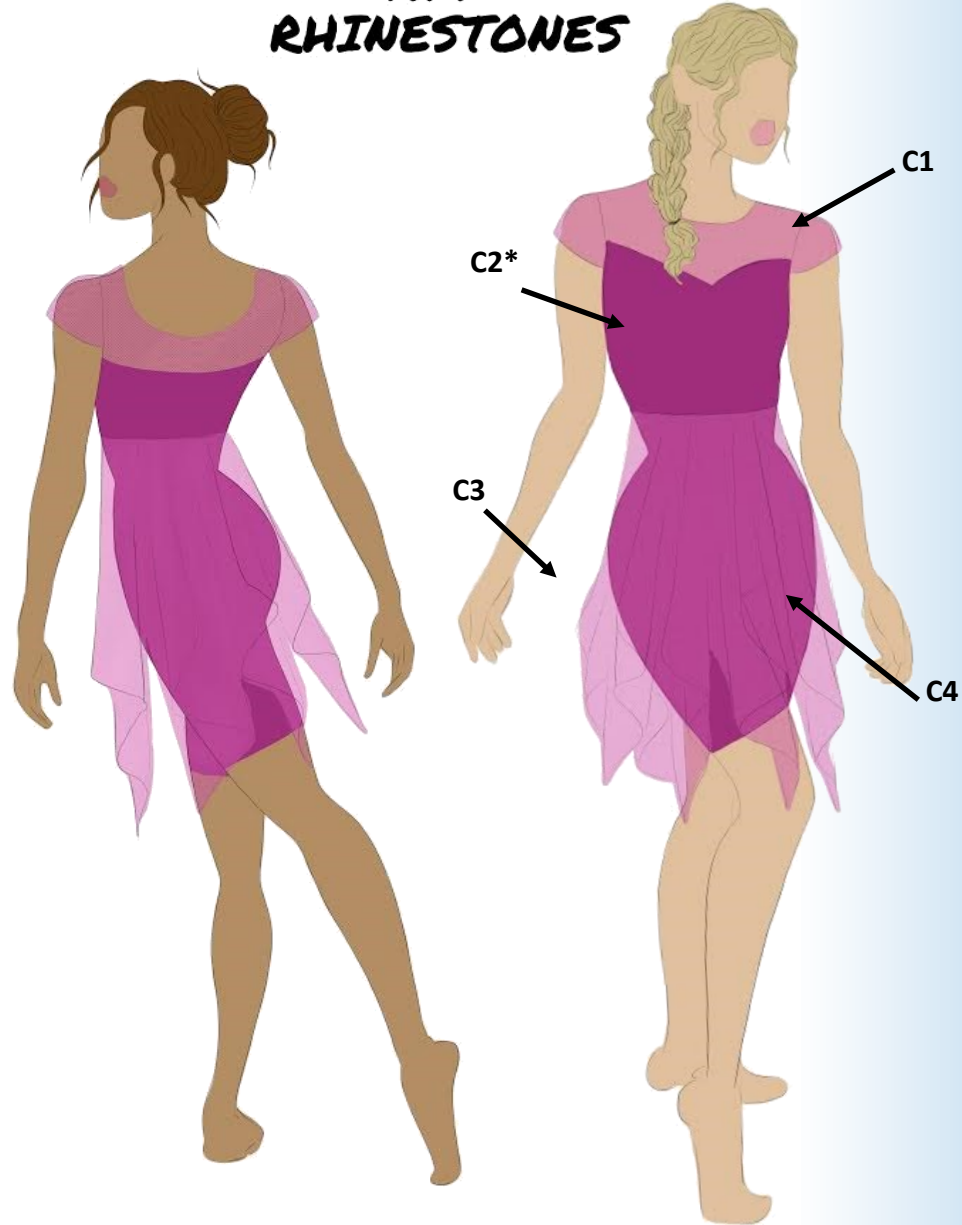

**99334** Sweetheart dress cap sleeves with a fly away skirt. Shown in: Orchid shiny top and short, Merlot LG lace yoke and sleeves, Merlot mesh skirt.

\*Color code also available with sequin.



**99335** Asymmetrical dress with capri length unitard. Shown in: Specialty Foil top, Gold Zsa Zsa strap and belt, Gold shiny capri and Ivory mesh skirt.



\*Color code available with sequin. +Color code not available in mystique or sequin





**99336** Mock neck sleeveless dress with a high low mesh skirt and attached biketard. Shown in: Specialty print top, Gold mystique collar and belt, Mallard matte short and Mallard mesh skirt .



**99336BOY** Mock neck tank with straight leg short . Shown the same as above.

# SUBLIMATE

99336 & 99336BOY  
shown with sublimated  
fabrics

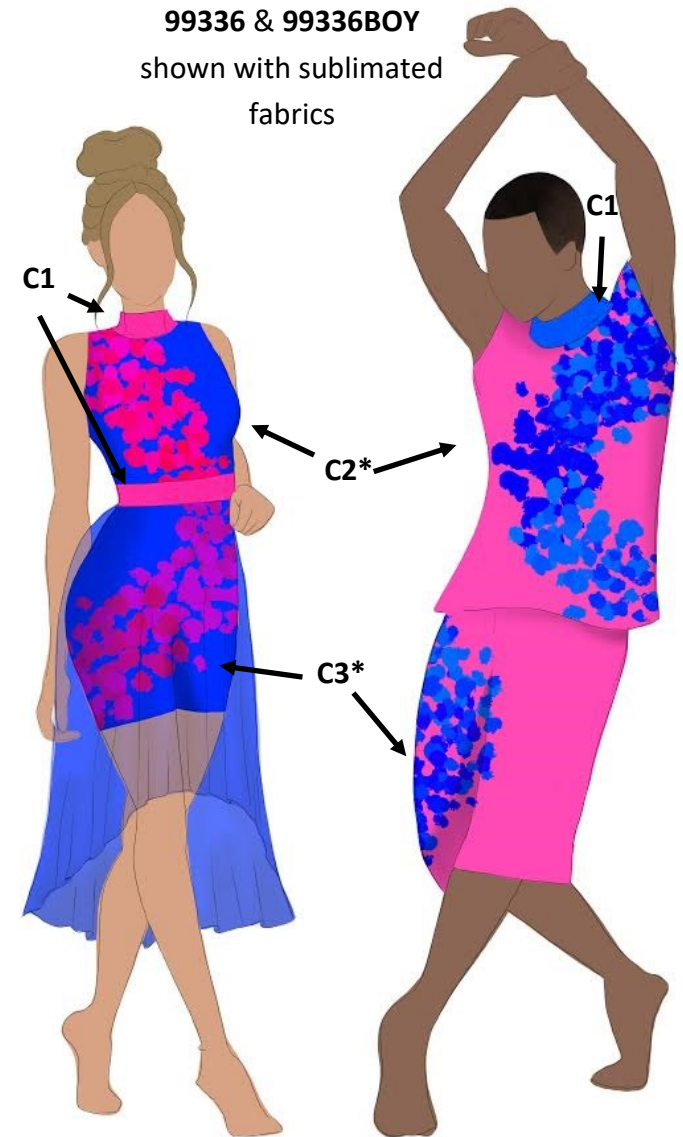

\*Color code also available with sublimation or sequin.

**ADD TWILL!**

**BHS**

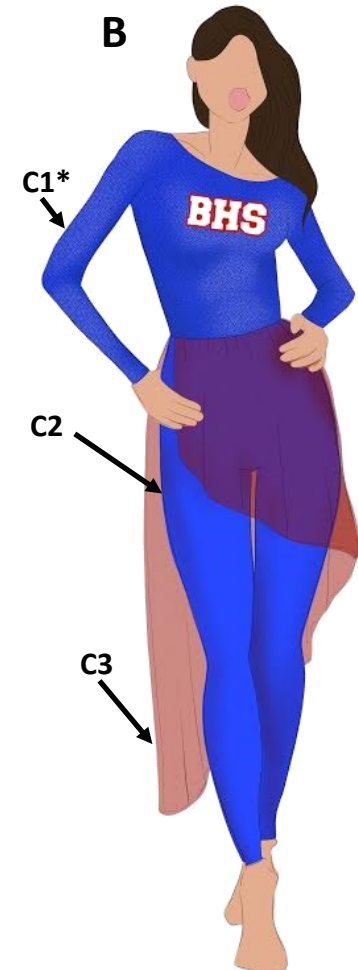

**A.) 99325SH** Boatneck long sleeved dress with asymmetrical mesh skirt and attached biketard.  
Shown in: Navy velvet top, Steel shiny short and Steel mesh skirt.

**B.) 99325LEG** Boatneck long sleeved dress with asymmetrical mesh skirt and attached legging

\*Color code also available with sequin.



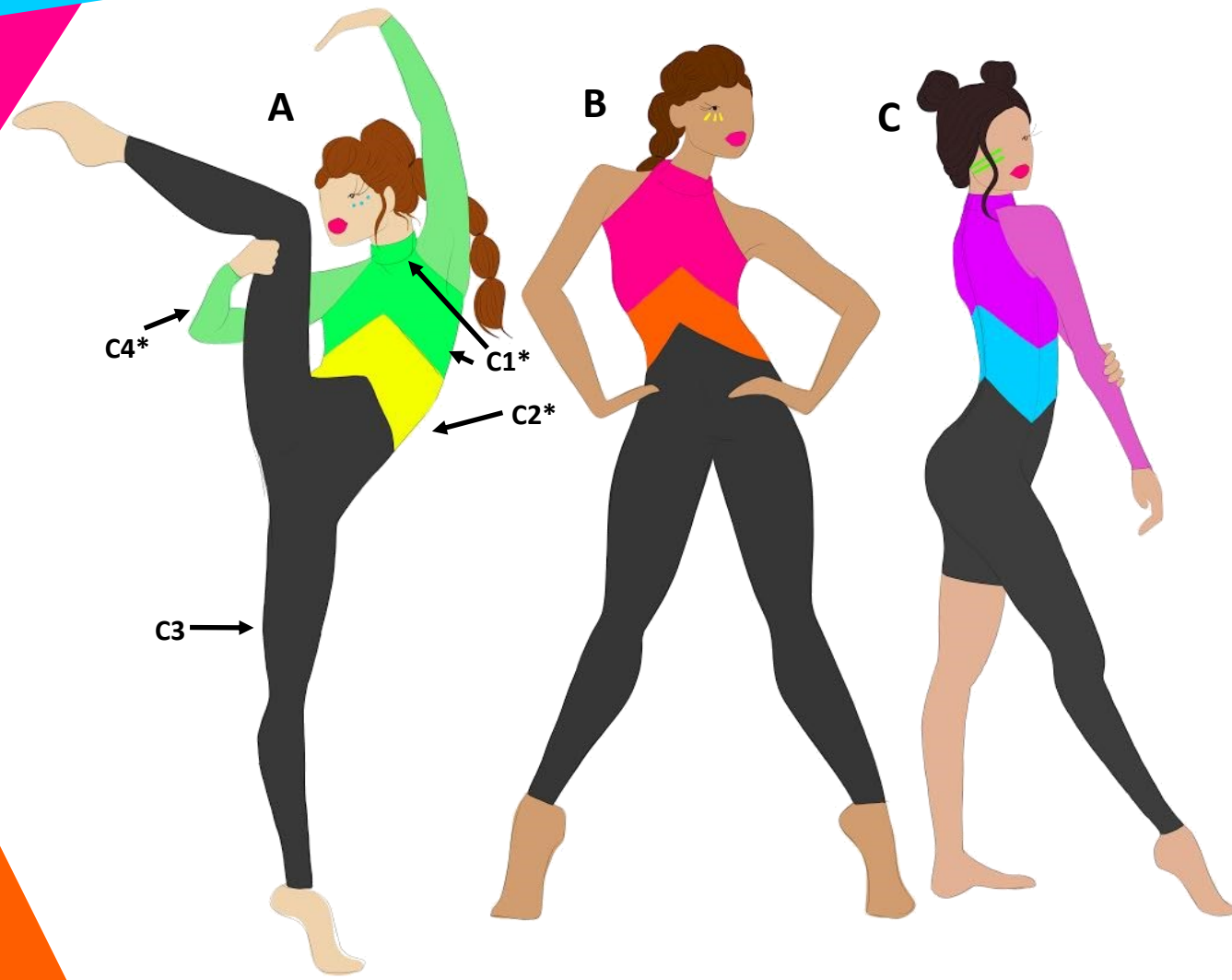

- A.) 96319 chevron color block long sleeve unitard
- B.) 96320 chevron color block sleeveless unitard
- C.) 96321 chevron color block long sleeve asymmetrical pant unitard

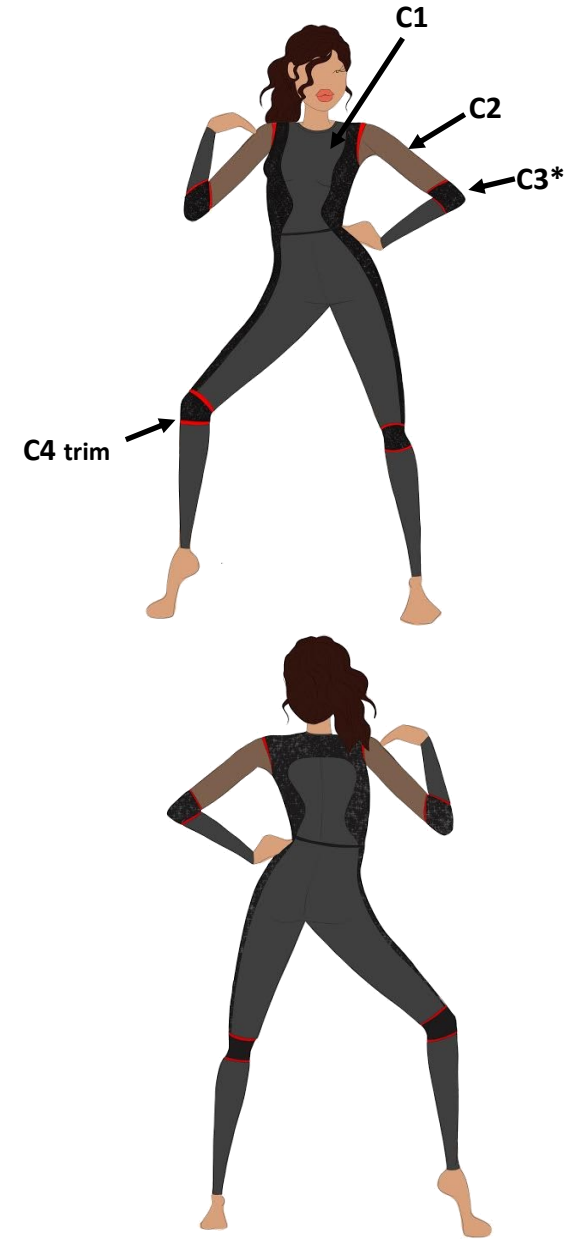

96322 Long sleeve unitard with futuristic style lines, multiple fabrics and accent trim.

\*Color code also available with sequin.

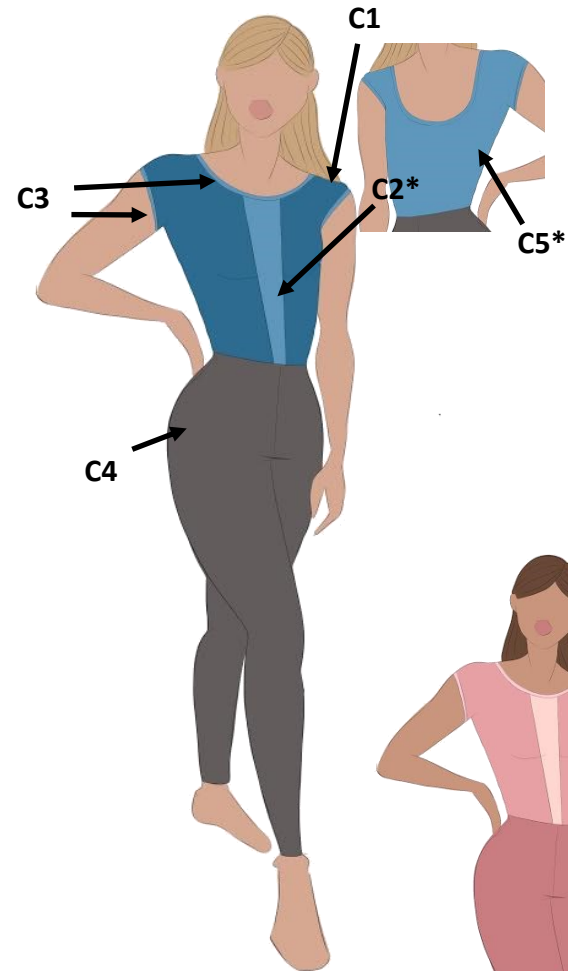

**76319** Carolina Unitard with capped shoulders and trim.

\*Color code also available with sequin.

# UNITARDS

STOCK DESIGN CHOSE YOUR FABRICS



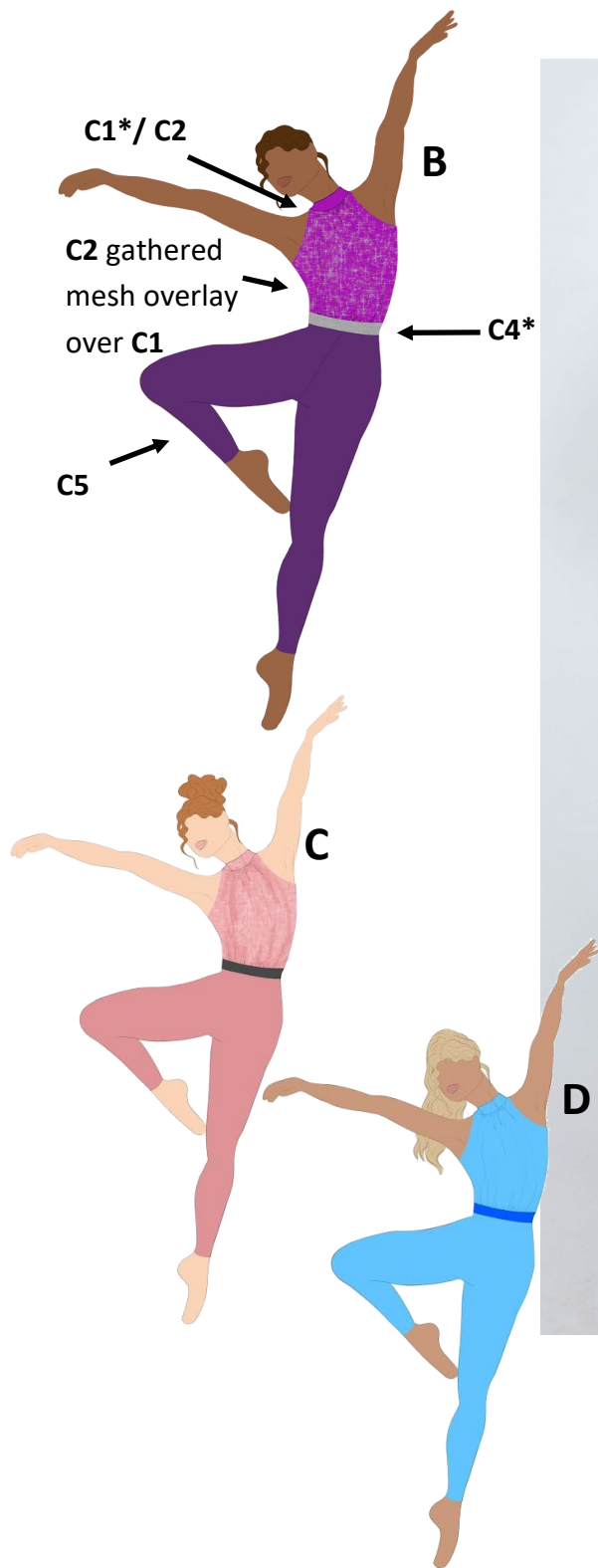

**96315** Mesh overlay mock neck unitard. Shown in: White/Silver Zsa Zsa top, Steel mesh overlay top, Black velvet legging.

\*Color code also available with sequin.



A

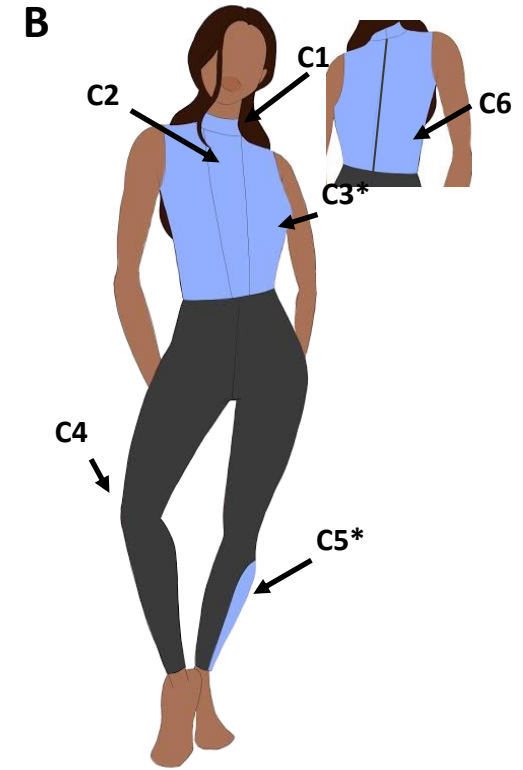

**96314** Mock neck color blocked center panel unitard with contrasting side panel on the leg  
 Shown in: Green slick top and side accent on legging, Black mesh back and front accent, and black matte legging.

\*Color code also available with sequin.



**ART PROOF  
TO PRODUCTION!**



**Send us your art and receive an art proof for approval before production!**

**96316** Mock neck asymmetrical sleeve and pant unitard. Shown in sublimated design.



EASY PREGAME  
UNIFORM  
ADD A SKIRT  
FOR PARADES



ADD A SKIRT!

See page 30-31



96318 Mock neck tank unitard.  
Shown in sublimated design.

SUBLIMATED DESIGNS

ART FEES APPLY



UNITARDS  
ARE UNISEX

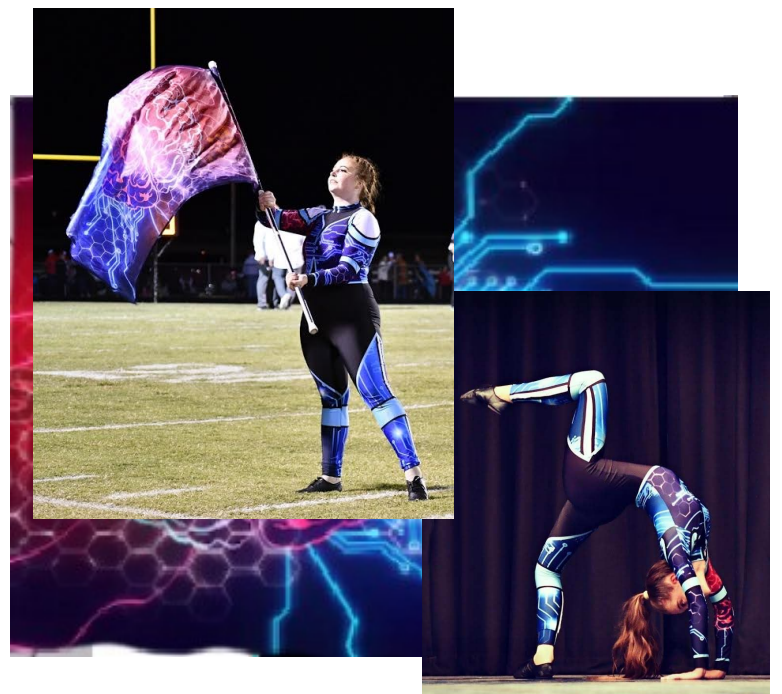

96317 Mock neck long sleeve unitard. Shown in sublimated fabrics.

Art fees apply to all new sublimated designs

Customer Approved

Art Proof



FRONT



BACK

Final Product



**ALSO COMES IN STOCK FABRICS**

**89327** Mock neck tank dress with keyhole back and shelf bra. Shown in these fabrics: White/Silver Zsa Zsa dress and Silver mystique collar.



## EASY PREGAME UNIFORM



FRONT



BACK



**89331** Tank Fitted Dress. With sublimation you can customize this simple flattering dress into any look you want. Pictured on the left is the art proof of the front and back of the dress and on the right is the garment that came from that design. Shown in sublimated fabric.

See page 32 and 33 for basic bottoms to pair with this design.

**68357** Jacket with full front and back lining. Shown in sublimated fabrics. Can also order stock fabrics.



Choose your coordinating trim color from our wide color selection on page 36 and 37. Not available in sequin.

# SUBLIMATE



RIGHT SLEEVE

FRONT RIGHT

FRONT LEFT

BACK

LEFT SLEEVE



RIGHT SLEEVE



FRONT RIGHT



FRONT LEFT



BACK



LEFT SLEEVE



RIGHT SLEEVE



FRONT RIGHT



FRONT LEFT



BACK



LEFT SLEEVE

Art fees apply to all new sublimated designs



# CUSTOMIZE

# YOUR TEAMS

# LOOK!

## FLEX LETTERS



**84342** Mock neck tear drop hole fitted tank. Shown in Brick matte

\*Available in sequin or sublimation.

## RHINESTONES



**84348** Mock neck long sleeve mesh and sequin top . Shown in these fabrics: Black mesh sleeves and yoke, Black mystique collar, Black Zsa Zsa top.

\*Color code also available in sequin

# TWILL LETTERING

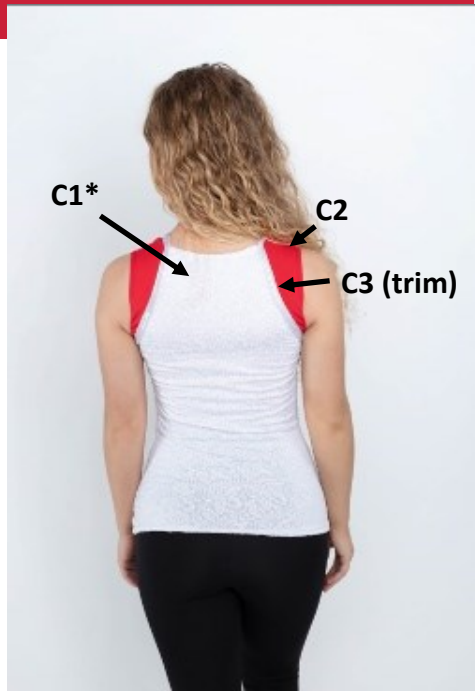

**84340** Color block fitted tank. Shown in these fabrics: White Zsa Zsa top, Crimson matte accents and Silver mystique trim.

\*Color codes also available in sequin or sublimation

# TEAM TOPS

STOCK DESIGN CHOSE YOUR FABRICS





# CUSTOMIZE YOUR DESIGN

**Customize your team top to show your teams school colors!**

Team colors in Sequin fabric pictured on the left listed from top to bottom. White/Silver, Gold, Red, Wine, Purple, Kelly, Navy, Royal, Columbia, White, Yellow and Orange.

**Add Flex Letters or Twill to ANY Team Top!**

More colors and fabrics listed on pages 36-37.

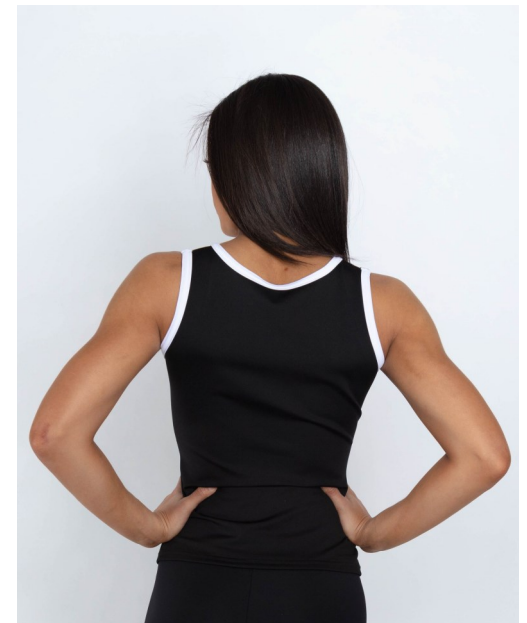

**84346** Color block trim fitted tank. Shown in: Gold Zsa Zsa top, Black dryflex back and accents and White dryflex trims.



**84314T** Scoop neck color block racer back fitted tank. Shown in: Athletic grey top and Black mesh straps and back yoke.

\*Color code also available in sequin

# CAN ORDER IN SUBLIMATION OR SOLIDS!

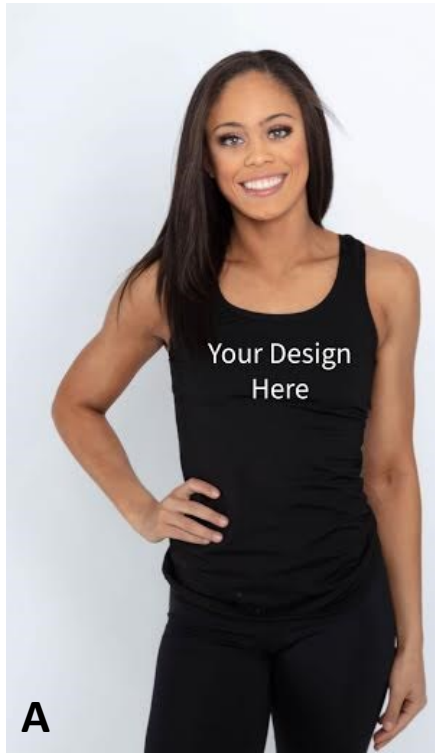

**A**



**B**



**C**



**D**

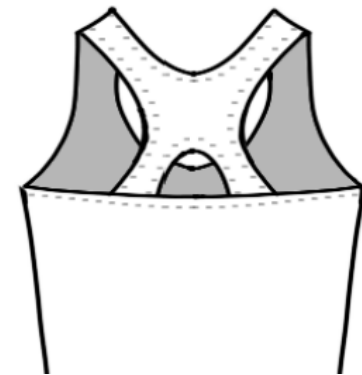

**A.) 04102** Scoop neck fitted tank with racer back. Shown in Black matte.

**B.) 04103** Scoop neck fitted tank with racer back and trim . Shown as sublimated.

**C.) 84311** Scoop neck fitted tank with tank back. Shown as sublimated.

**D.) 84349** Scoop neck fitted tank with x back. Shown as sublimated.

Art fees apply to all new sublimated designs





**39112** Asymmetrical shoulder tie off shoulder sleeve dress. Shown in Navy mesh.

Available in Glossy Flow, Fine Knit or Mesh



**ALSO COMES IN MESH**



**31603** Gaucho pant. Shown in Metal Glossy Flow.



**31604** Ankle length gaucho pant. Shown in Burgundy Glossy Flow.

**34105** Boat neck 3/4 sleeve overlap back  
flowy top reversible top. Shown in: Merlot  
mesh.



**ALSO COMES IN  
GLOSSY FLOW**



Shown in Eggplant  
Glossy Flow

# BASICS

STOCK DESIGN CHOSE YOUR FABRICS



**34106** Short sleeve tunic available in mesh or glossy flow. Shown in: Ivory mesh.



**99329** Mock neck raglan slit sleeve dress with attached biketard. Also available with mesh as shown in the sketch. Shown in: Steel Fine Knit.

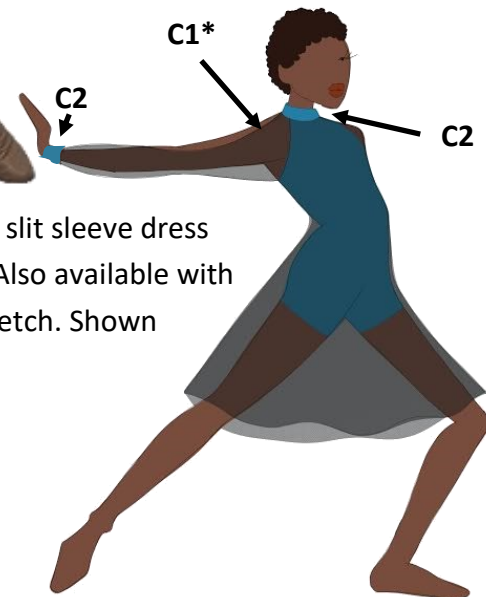

\*Color code also available with sequin.



ALSO COMES IN  
GLOSSY FLOW



**39113** Tank tea length dress with high side slit . Shown in: Turquoise mesh and Teal Glossy Flow.



# ADD A SEPARATE SKIRT

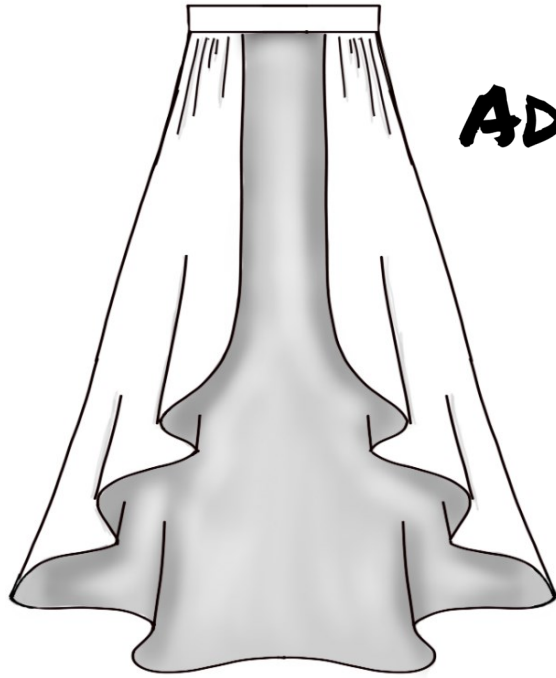

**92302** Slightly gathered multiple position cascading skirt on waistband.

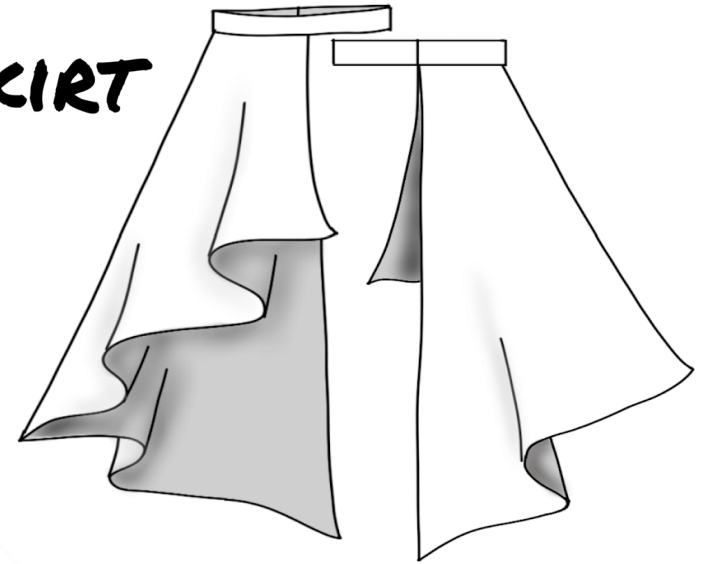

**92304** Asymmetrical half skirt on waistband.

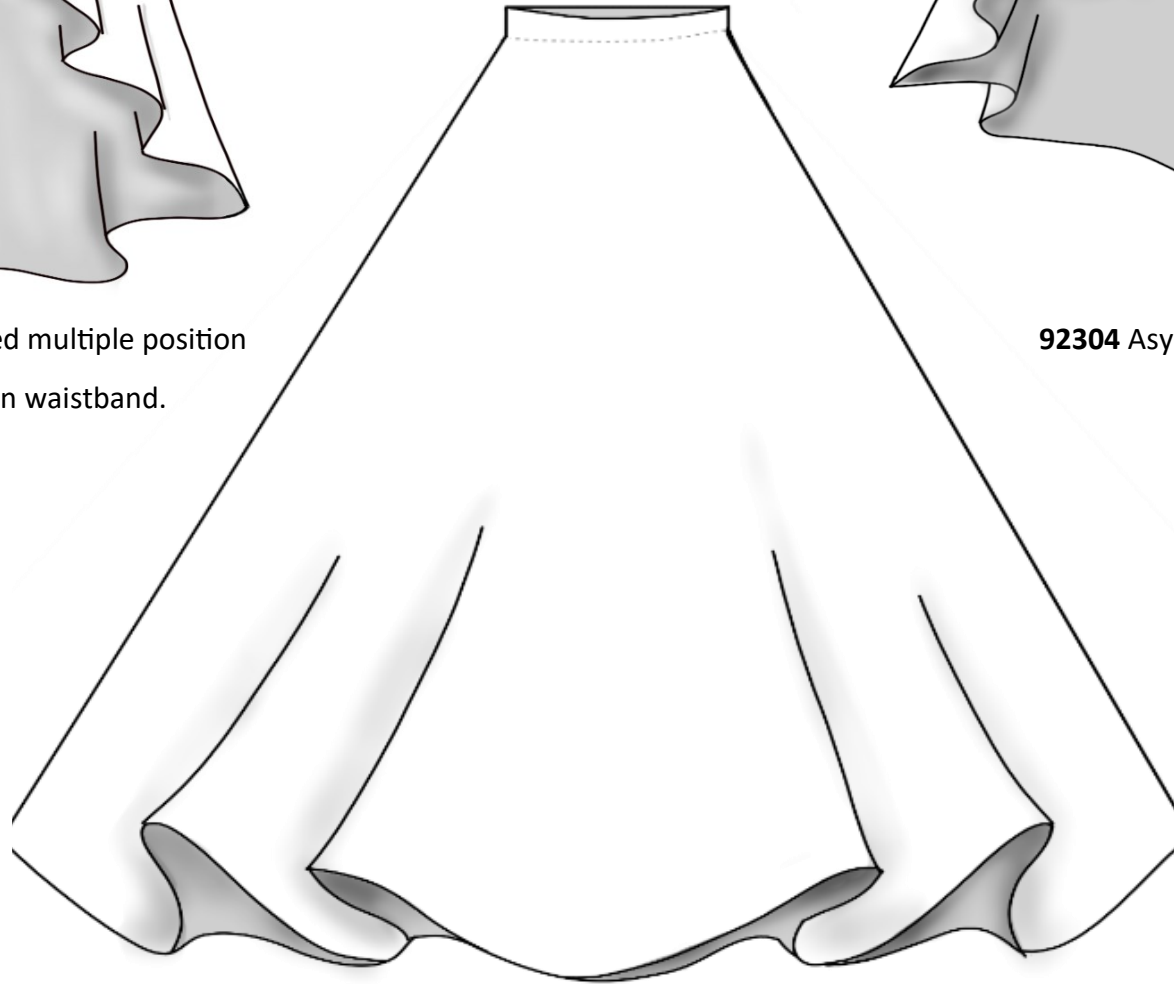

**02025** Full circle skirt with elastic waistband.

# PAIR GARMENTS TO CREATE NEW LOOKS

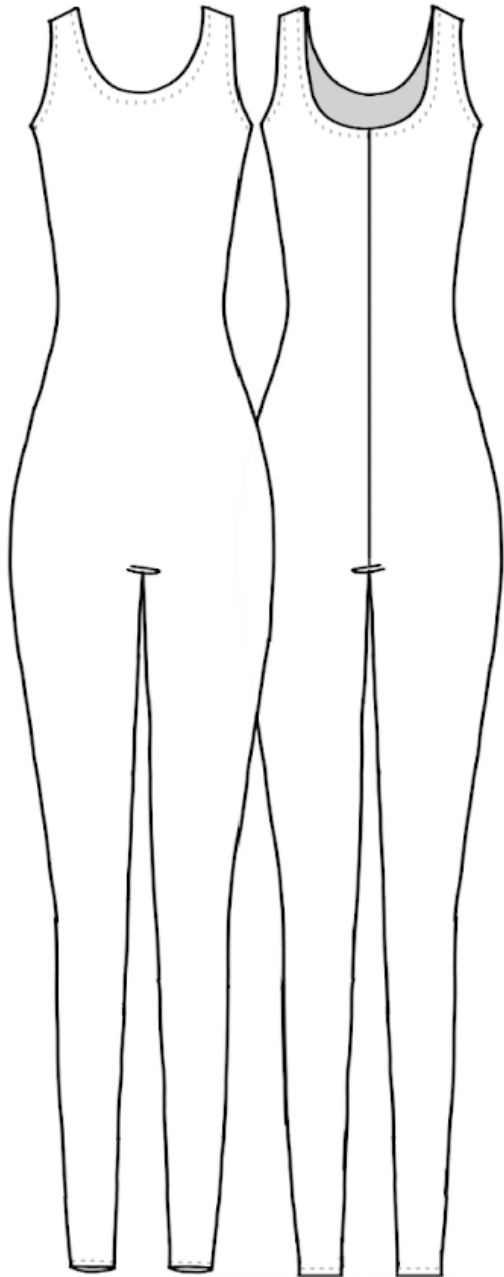

**06502**

Fitted tank unitard that is a staple item every color guard team needs. Can be sublimated to fit your shows theme! Sketch shows option of sublimation paired with the **92303** skirt in mesh.

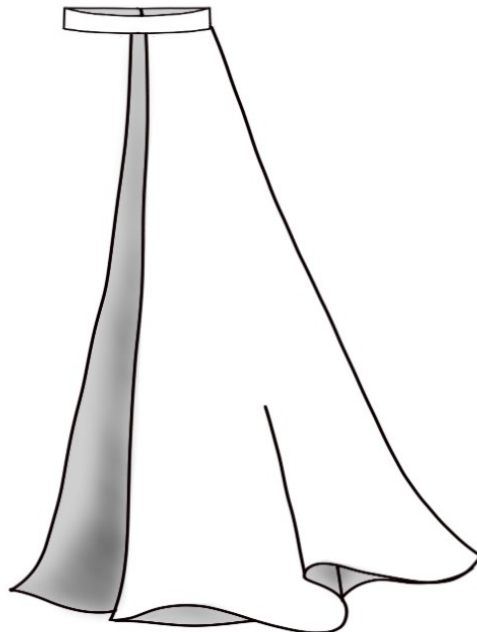

**92303**

Elastic waistband multiple position half skirt





**★ STOCK STYLE**

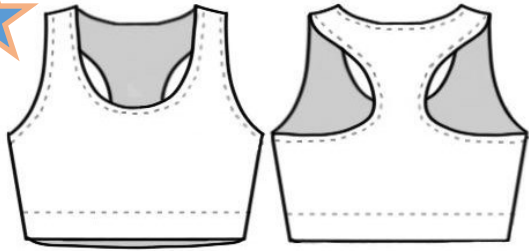

**04105**  
RACERBACK BRA

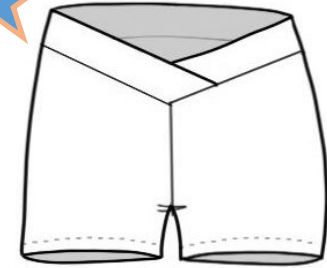

**87506**  
RISE: MEDIUM  
INSEAM: 2.75"



04105, 31123

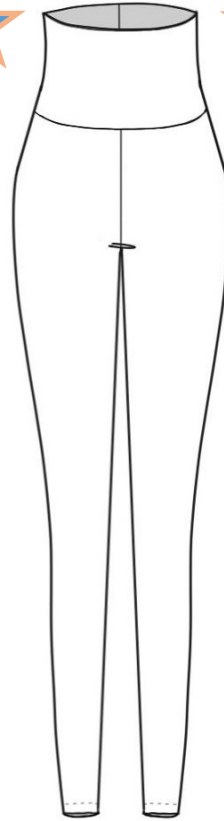

**31123**

HIGH RISE, WIDE BAND  
LEGGING

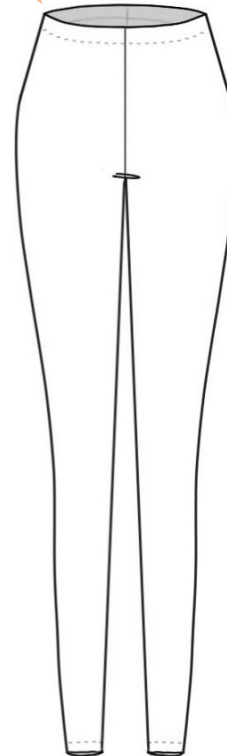

**31101**

LOW RISE, ELASTIC  
WAIST LEGGING

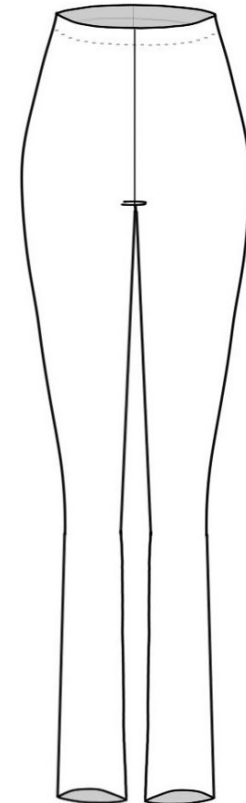

**31119**

MID/HIGH RISE  
SUPER SKINNY PANT

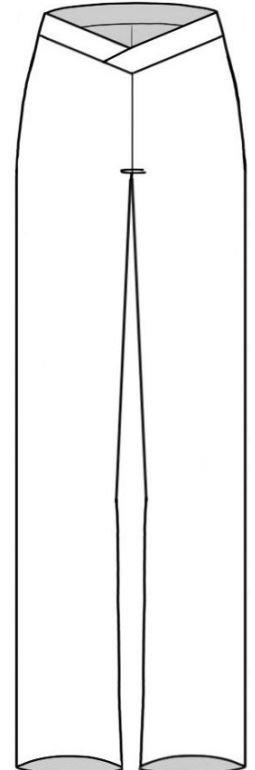

**31127**

MID/LOW RISE  
JAZZ PANT

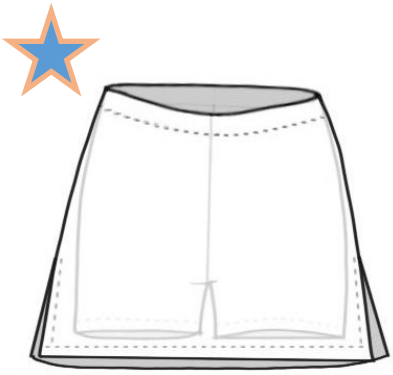

**82102**

SKORT RISE: MEDIUM 1"  
ELASTIC  
INSEAM: 2" (SHORTS)



**37114**

RISE: MEDIUM  
INSEAM: 4"



**87505**

RISE: HIGH  
INSEAM: 2.75"

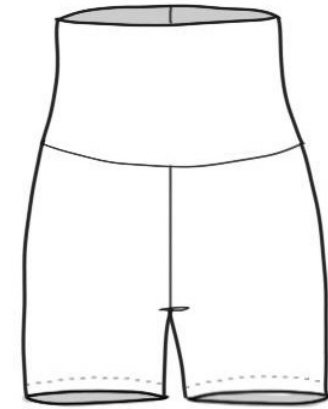

**87507**

RISE: HIGH  
INSEAM: 4"

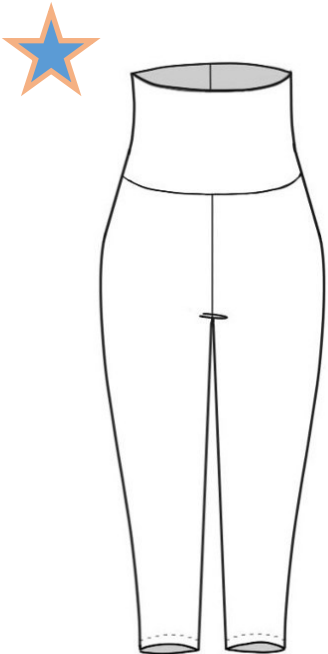

**31124**

HIGH RISE CAPRI  
WIDE WAISTBAND



**31125**

MID RISE CAPRI WITH  
NO ELASTIC WAISTBAND

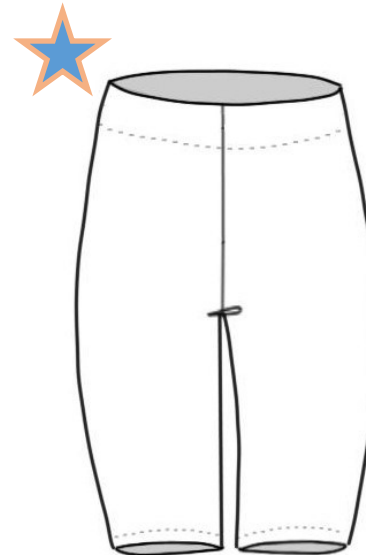

**37122**

RISE: MEDIUM 2" ELASTIC  
INSEAM: 9.5

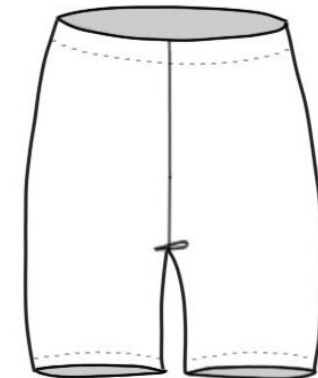

**37115**

RISE: MEDIUM 1" ELASTIC  
INSEAM: 6"





74124

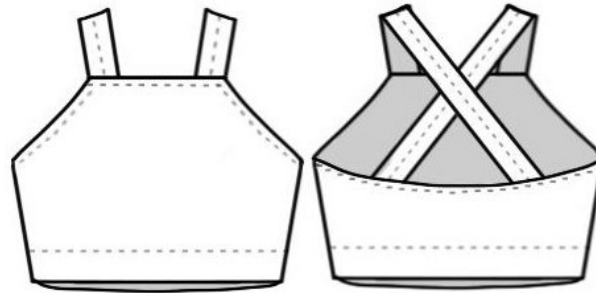

74124

SQUARE NECK CROSS BACK BRA

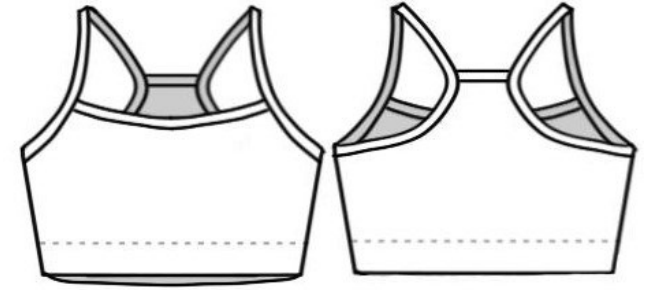

74126

CAMI RACER BRA

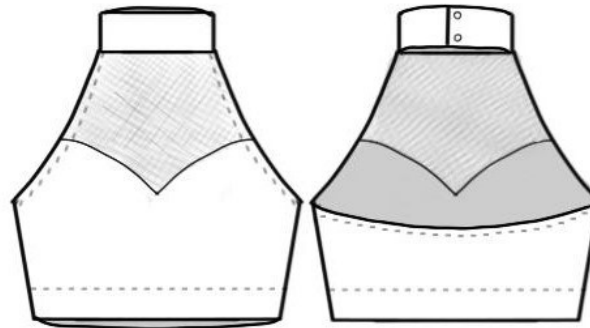

74307

MESH CHEST SWEETHEART MOCK NECK BRA

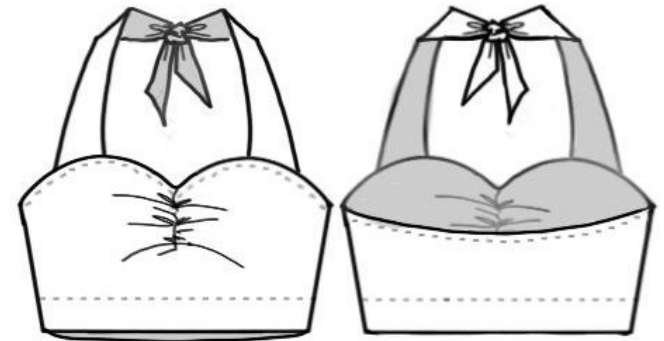

74114

SWEETHEART TIE BACK BRA



84331

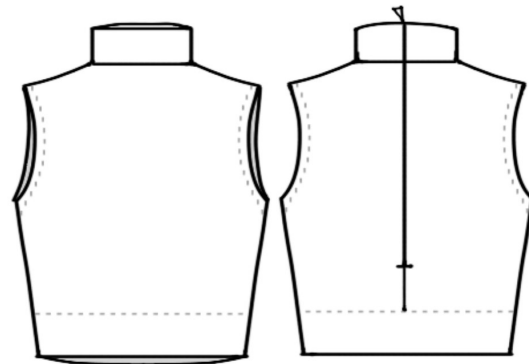

84335 MOCK NECK SLEEVELESS CROP (All one color)

84331 PICTURED AS SECOND COLORWAY (2 colors)

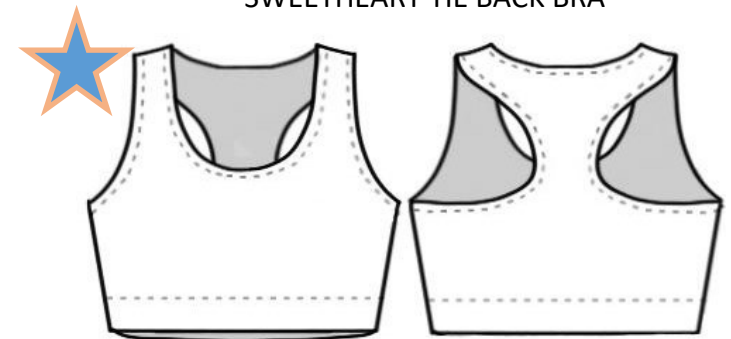

04105

RACERBACK BRA

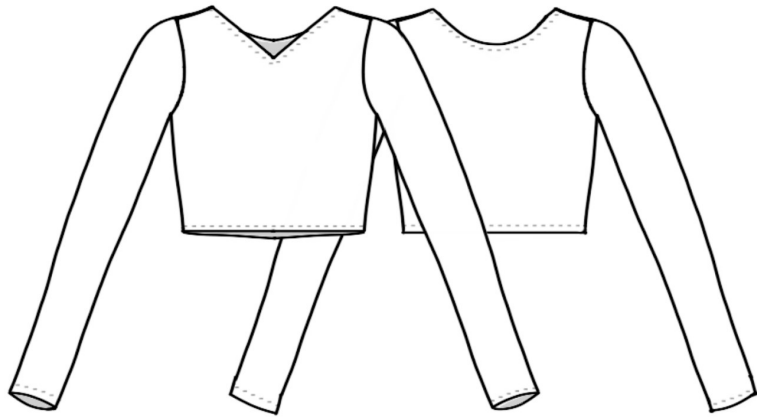

**84338**

V NECK LONG SLEEVE

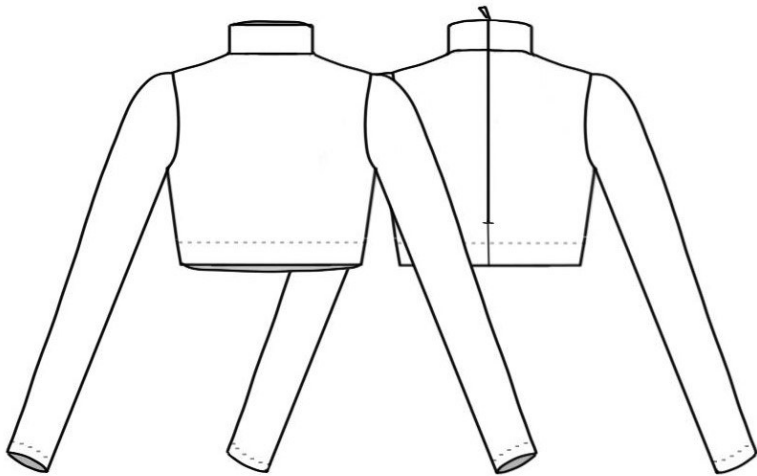

**84114**

ZIP BACK MOCK NECK CROP



**84332**

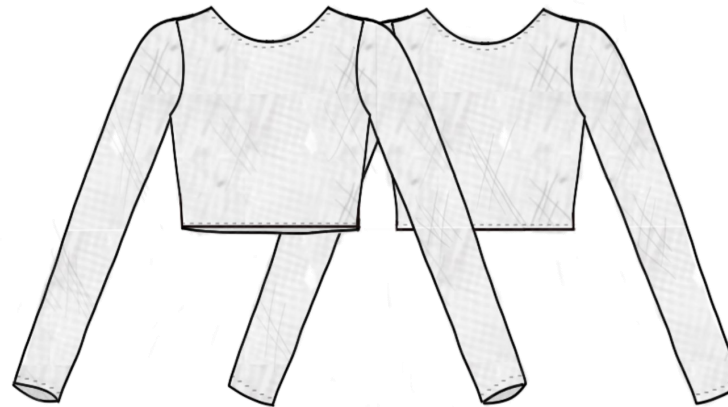

**84337**

MESH LONG SLEEVE CROP









# SEQUIN + FOIL

	White Mystique		Gunmetal Zsa Zsa
	Silver Mystique		White Zsa Zsa
	Café Gold Mys-		Silver Zsa Zsa
	Gold Mystique		Gold Zsa Zsa
	Orange Mystique		Orange Zsa Zsa
	Red Mystique		Red Zsa Zsa
	Wine Mystique		Wine Zsa Zsa
	Berry Mystique		Berry Zsa Zsa
	Eggplant Mystique		Light Pink Zsa Zsa
	Columbia Mystique		Merlot Zsa Zsa
	Light Blue Mystique		Grape Zsa Zsa
	Ocean Mystique		Purple Zsa Zsa
	Royal Mystique		Columbia Zsa Zsa
	Kelly Mystique		Turquoise Zsa Zsa
	Navy/Black Mystique		Light Blue Zsa Zsa
	Black Mystique		Royal Zsa Zsa
	Navy/Black Zsa Zsa		Kelly Zsa Zsa
	Black Zsa Zsa		



# MATTE, SHINY + MESH

	Off White
	Ivory
	Light Peach
	Natural
	Mocha
	Khaki
	Sable
	D. Rose
	Bubblegum Pink
	Blush Pink
	Medium Pink
	Sweet Potato
	Deep Pink
	Lipstick
	Fuchsia
	Raspberry
	Shocking Coral
	Cherry
	Crimson
	Brick
	Copper
	Chocolate
	Hunter
	Olive

	Wine
	Merlot
	Plum
	Purple
	Deep Purple
	Bluish Purple
	Lilac
	Orchid
	Turquoise
	Corona
	Royal
	Sapphire
	Mint Green
	Seafoam
	Jade Green
	Mallard
	Lemon Yellow
	Samba Yellow
	Yellow
	Athletic Gold
	Gold
	Cantaloupe
	Orange
	Paprika

	Hibiscus
	Violet
	Cerise
	Coral
	Neon Pink
	Neon Orange
	Neon Green
	Neon Yellow
	Celery
	Moss Green
	Apple Green
	Glo Green
	Kelly Green
	Forest Green
	Baby Blue
	Aquamarine
	Sky Blue
	Arabian Blue
	Teal
	Tropical Turquoise
	Peacock
	Periwinkle



**0495G** Bloch Girls Neo Flex

Slip on Jazz Shoe

Comes in Tan and Black



Nude

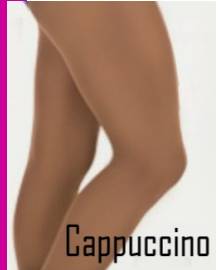

Cappuccino

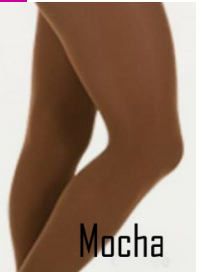

Mocha

**Skin tones  
available  
Also comes in  
plus sizes!**



**95704** Bodytight



**Sportswear Duffel**

Zippered main compartment has large U-shaped opening with two zipper pulls  
\* Separate zippered compartments at each end \* Black web handles with self-fabric handle wrapper reinforced at stress points \* Adjustable and detachable shoulder strap \* 420-denier nylon with PVC coating \* Plastic hardware \* Piping trim \* Removable inside bottom board 22" 11" x 11"



**95707 Eurotard Euroskins Leotard**

**Gloves come in Nude & Black**



**Grip Factor Fingerless Glove**



**Fingerless Gloves**



**95624 Eurotard Seamless Padded Bra**

**Skin tones available**  
**Also comes in plus sizes!**



**Capezio Adult Full Seat Dance Belt**



### How to Order Catalog Items:

1. Choose Items: Write down style number and description.
2. Choose Fabrics: Select fabrics and indicate placement via C1, C2 Etc.
3. Choose Sizes based on Size Chart
4. Email your order to Sales@bpdesigns.us or call us at 877-618-8777 to place your order with a sales rep.
5. Indicate date you need your items in hand on your order.

### How to order Custom Items:

Email sales@bpdesigns.us to get your custom order started.



For more styles and downloads visit [www.bpdesigns.us](http://www.bpdesigns.us)

For more catalogs and men's options visit [www.bpdesigns.us/catalogs](http://www.bpdesigns.us/catalogs)

### Important Info:

**Color Swatches:** Color Swatches are available by request. Email your swatch requests to sales@bpdesigns.us.

**Cancellations/ Returns:** No orders may be cancelled once put into production, Art and design fees may apply if order is cancelled before production. Basic in Stock items may be returned if unopened and unused. Custom or embroidered items may not be returned.

We offer 100% quality guarantee against defects. Defects/ Alterations Claims must be returned within 10 working days from receiving your order. Alterations can be quoted at any time. Any costumes returned for alteration must be returned clean. Dirty Garments will have a \$10 Cleaning fee added before an alteration can be made.

**Delivery Time Frame:** Please check our current costume ship date before placing your order. Orders typically ship between 6-8 weeks after your order is placed.

### Payment:

To begin production orders require a 50% Deposit or an official school issued purchase order for the full amount of the order. Orders are not put into production until a PO or Deposit are received. If a deposit was made, the remainder of the total is due in order to release shipment.

We accept Credit Card, Check or Cash for Payment. Credit Card payments will have a 3% Convenience fee.

### Sales Tax:

Sales Tax will be added to all Oklahoma Customers orders, unless tax exempt. If your organization is tax exempt, please provide your tax exempt letter or sales tax permit when placing your order.

Adult (Unisex)

Size	Bust	Waist	Hip	Girth	Sleeve Length* (top of shoulder to Wrist)	Inseam* (legging/loose)
AXS	30-32	22-24	32-34	54-56	20	31/34
AS	33-34	25-27	34-35	56-58	21	31/34
AM	35-36	28-29	36-37	58-60	22	31/34
AL	37-38	29-30	38-39	60-62	23	31/34
AXL	39-40	31-32	40-41	62-64	24	31/34
A2XL	41-42	33-34	42-43	64-66	25	31/34
A3XL	43-44	35-36	44-45	66-68	25	31/34
A4XL	45-47	37-39	46-48	68-71	25	31/34

Youth-Girls & Boys

Size	Bust	Waist	Hip	Girth	Sleeve Length* (top of shoulder to Wrist)	Inseam* (legging/loose)
Y2XS	18-20	18-20	18-20	32-35	12	13/14.75
YXS	20-22	20-21	20-22	35-38	13.5	15/17
YS	22-25	21-22	22-25	38-43	15.5	19.5/22
YINT**	25-27	22-23	24-27	42-45	16	22.5/25
YM	26-29	23-24	26-30	44-48	16.5	23.5/26
YL	29-32	25-26	31-34	49-53	18.5	25.5/28
YXL	32-33	27-28	35-36	54-56	19.5	27.5/30

\*\*YINT is a half size step between the normal size step of YS to YM.

Men (Men's styles only)

Size	Chest	Waist	Hip	Girth	Sleeve Length* (top of shoulder to Wrist)	Inseam* (legging/loose)
MXS	30-32	26-28	32-34	52-54	24	32/35
MS	32-34	28-30	34-35	55-58	24	32/35
MM	34-36	31-32	36-37	59-61	24.5	32/35
ML	36-38	33-34	38-39	62-65	25	32/35
MXL	38-40	35-37	40-41	66-68	25.5	32/35
M2XL	40-42	38-40	42-43	69-71	26	32/35
M3XL	42-44	41-43	44-45	72-74	26.5	32/35
M4XL	45-47	44-45	46-48	75-77	26.5	32/35

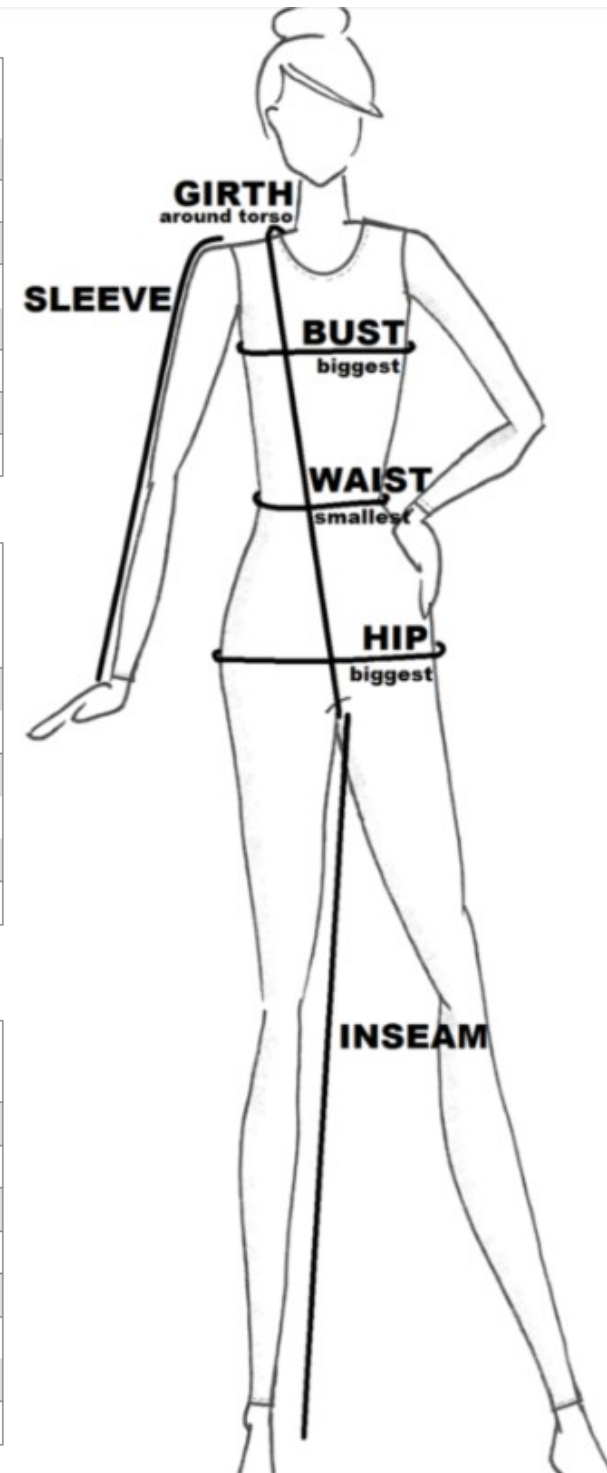



**MADE IN  
THE USA!**

Autumn Pappan is the head of the design team at Black and Pink. Our staff will work with you to make your designs come to life. It all starts with the consultation. Bring us your ideas and inspiration; our team will help you navigate through the process to select the material that best matches your concept. We offer the option to order a sample prior to placing the order. This gives you the opportunity to make changes before you place your order. Making your vision come to life is our main goal and our design team can help you do that.

Schedule your Design Appointment in person or over Zoom!

For any inquiries, pricing, or to set up an appointment call 877-618-8777 or email us at [sales@bpdesigns.us](mailto:sales@bpdesigns.us)

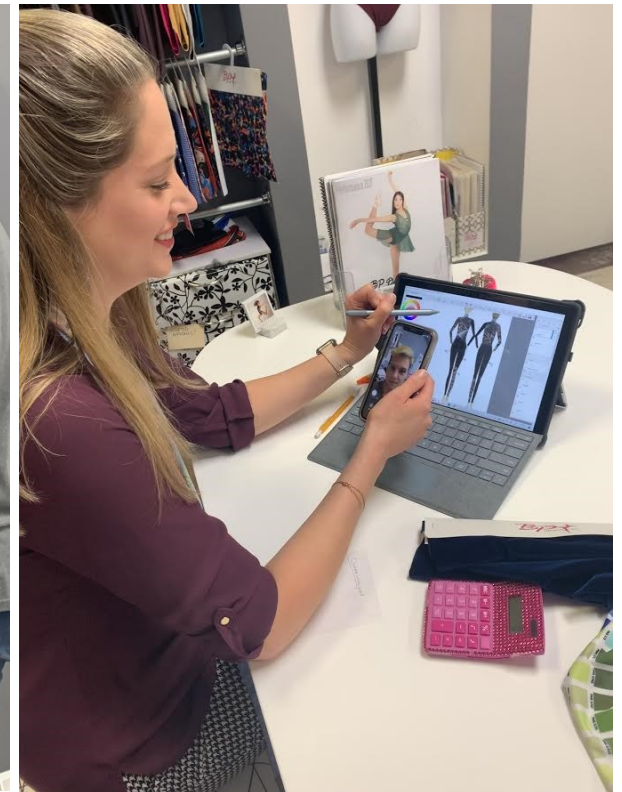

# FULL CUSTOM ORDERS

FROM CONCEPT → TO DESIGN → TO PERFORMANCE

Sweet!  
 We are thinking a Dia De Los Muertos themed show. Probably leaning toward the show title of "The Other Side". So we have some cool ideas. Here are some colors and some ideas I'm thinking..the dress bottom like the picture and have it fade into the skeleton top similar to the other picture.  
 Just an idea. Let me know what you think. I am open for suggestions.

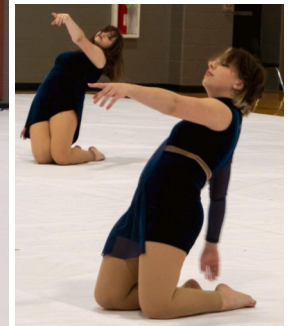
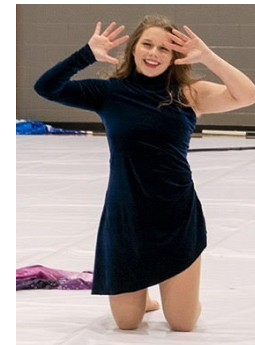
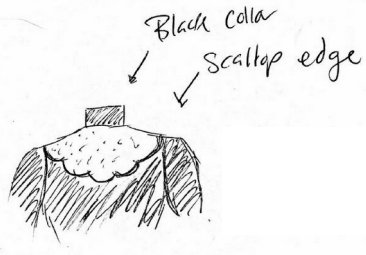
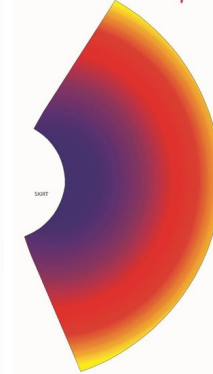
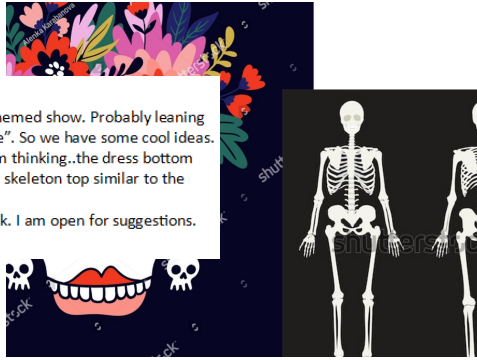





**MADE IN THE USA!**